



JRC SCIENCE FOR POLICY REPORT

Best Available Techniques (BAT) Reference Document for the Ferrous Metals Processing Industry

*Industrial Emissions Directive
2010/75/EU
(Integrated Pollution
Prevention and Control)*

Aries, E., Gómez, Benavides, J., Mavromatis, S., Klein, G.,
Chronopoulos, G., Roudier, S.

2022



This publication is a Science for Policy report by the Joint Research Centre (JRC), the European Commission's science and knowledge service. It aims to provide evidence-based scientific support to the European policymaking process. The contents of this publication do not necessarily reflect the position or opinion of the European Commission. Neither the European Commission nor any person acting on behalf of the Commission is responsible for the use that might be made of this publication. For information on the methodology and quality underlying the data used in this publication for which the source is neither Eurostat nor other Commission services, users should contact the referenced source. The designations employed and the presentation of material on the maps do not imply the expression of any opinion whatsoever on the part of the European Union concerning the legal status of any country, territory, city or area or of its authorities, or concerning the delimitation of its frontiers or boundaries.

Contact information

Name: European IPPC Bureau, JRC Directorate B - Growth and Innovation, European Commission
Address: Edificio Expo, c/ Inca Garcilaso 3, E-41092 Seville, Spain
Email: JRC-B5-EIPPCB@ec.europa.eu
Tel.: +34 95 4488 284

EU Science Hub

<https://joint-research-centre.ec.europa.eu>

JRC131649

EUR 31321 EN

PDF ISBN 978-92-76-59143-6 ISSN 1831-9424 [doi:10.2760/196475](https://doi.org/10.2760/196475) KJ-NA-31-321-EN-N

Luxembourg: Publications Office of the European Union, 2022

© European Union, 2022



The reuse policy of the European Commission documents is implemented by the Commission Decision 2011/833/EU of 12 December 2011 on the reuse of Commission documents (OJ L 330, 14.12.2011, p. 39). Unless otherwise noted, the reuse of this document is authorised under the Creative Commons Attribution 4.0 International (CC BY 4.0) licence (<https://creativecommons.org/licenses/by/4.0/>). This means that reuse is allowed provided appropriate credit is given and any changes are indicated.

For any use or reproduction of photos or other material that is not owned by the European Union/European Atomic Energy Community, permission must be sought directly from the copyright holders. The European Union/European Atomic Energy Community does not own the copyright in relation to the following elements:

Cover picture credits in clockwise order starting from the left: 1. Hot steel on conveyor©Laurentiu Iordache - stock.adobe.com; 2. Roll of hot metal on the conveyor belt©MIRACLE MOMENTS- stock.adobe.com; 3. Production process of galvanized steel metal products©nisky2 - stock.adobe.com; 4. machine with conveyor belt with glowing metal frame in the production line of a steel mill©industrieblick - stock.adobe.com; 5. Metallic pieces galvanized on zinc bath©bogdanvija - stock.adobe.com.

How to cite this report: Aries, E., Gómez Benavides, J., Mavromatis, S., Klein, G., Chronopoulos, G. and Roudier, S., *Best Available Techniques (BAT) Reference Document for the Ferrous Metals Processing Industry*, Publications Office of the European Union, Luxembourg, 2022, doi:10.2760/196475, JRC131649.

Abstract

The Best Available Techniques (BAT) Reference Document (BREF) for the Ferrous Metals Processing Industry is part of a series of documents presenting the results of an exchange of information between EU Member States, the industries concerned, non-governmental organisations promoting environmental protection, and the Commission, to draw up, review and – where necessary – update BAT reference documents as required by Article 13(1) of Directive 2010/75/EU on Industrial Emissions (the Directive). This document is published by the European Commission pursuant to Article 13(6) of the Directive.

The BREF on Ferrous Metals Processing Industry covers the operation of hot rolling mills with a capacity exceeding 20 tonnes of crude steel per hour, the application of protective fused metal coats with an input exceeding 2 tonnes of crude steel per hour (this includes hot dip coating and batch galvanising), the surface treatment of ferrous metals using electrolytic or chemical processes where the volume of the treatment vats exceeds 30 m³ (when it is carried out in cold rolling, wire drawing or batch galvanising), as specified in Points 2.3 (a), 2.3 (c) and 2.6 of Annex I to Directive 2010/75/EU, respectively. This BREF also concerns independently operated treatment of waste water that are not covered by Directive 91/271/EEC as specified in point 6.11 of Annex I to Directive 2010/75/EU, provided that the main pollutant load originates from the activities covered in this BREF.

The BREF also covers the following:

- Cold rolling and wire drawing if directly associated with hot rolling and/or hot dip coating.
- Acid recovery, if directly associated with the activities covered by this BREF.
- The combined treatment of waste water from different origins, provided that the waste water treatment is not covered by Directive 91/271/EEC and that the main pollutant load originates from the activities covered by this BREF.
- Combustion processes directly associated with the activities covered by this BREF provided that:
 1. the gaseous products of combustion are put into direct contact with material (such as direct feedstock heating or direct feedstock drying), or
 2. the radiant and/or conductive heat is transferred through a solid wall (indirect heating)
 - without using an intermediary heat transfer fluid (this includes heating of the galvanising kettle), or
 - when a gas (e.g. H₂) acts as the intermediary heat transfer fluid in the case of batch annealing.

Important issues for the implementation of Directive 2010/75/EU in the ferrous metal processing (FMP) sectors are emissions to air and water as well as energy and water consumption. Chapter 1 provides general information on the FMP sector and on the industrial processes and techniques used within this sector. Chapters 2 to 6 provide, for each specific FMP sectors (i.e. hot rolling, cold rolling, wire drawing, continuous hot dip coating and batch galvanising), information on applied processes and techniques, environmental performance of installations, techniques to prevent or reduce the environmental impact of operating installations and emerging techniques.

Chapter 7 provides information on the emissions for processes common to more than one sector (i.e. emissions to air from acid recovery and emissions to water from treatment plants processing waste waters that originate from more than one FMP sector). Chapter 8 provides information on the common industrial processes, abatement systems and general techniques that are used across more than one sector in the FMP industry. Chapter 9 presents the BAT conclusions as defined in Article 3(12) of the Directive, both general and sector-specific. Chapter 10 is concerned with the concluding remarks and recommendations for future work. A number of annexes detailing the list of installations who participated to the data collection and other information on specific technical issues are presented in Chapter 11.

Acknowledgements

This report was produced by the European Integrated Pollution Prevention and Control Bureau (EIPPCB) at the European Commission's Joint Research Centre – Directorate B: Growth and Innovation under the supervision of Serge Roudier (Head of the EIPPCB) and Mikel Alvarez Lanbadaso (Acting Head of the Circular Economy and Industrial Leadership Unit).

The authors of this BREF were Eric Aries, Jorge Gómez, Stilianos Mavromatis, Gabriele Klein, Georgios Chronopoulos, and Serge Roudier.

This report was drawn up in the framework of the implementation of the Industrial Emissions Directive (2010/75/EU) and is the result of the exchange of information provided for in Article 13 of the Directive.

Major contributors of information were:

- among EU Member States: Austria, Belgium, Czechia, Denmark, Finland, France, Germany, Greece, Italy, Luxembourg, the Netherlands, Poland, Portugal, Romania, Slovakia, Spain, Sweden and the United Kingdom (until 31/01/2020);
- among industry: CEFIC (European Chemical Industry Council), EGGA (European General Galvanizers Association), ESA (European Sealing Association), EUROFER (European Steel Association), EUROMETAUX (European non-ferrous metals association), FEAD (European Federation of Waste Management and Environmental Services), ORGALIM (Europe's Technology Industries);
- among environmental non-governmental organisations: EEB (European Environmental Bureau).

Thomas Brinkmann (DG CLIMA) and Benoit Zerger (DG ENV) contributed significantly to the internal discussions and task force sessions realised for the development of this document while working at the EIPPCB during the comments assessment period.

The whole EIPPCB team provided contributions and peer reviewing.

This report was edited by Anna Atkinson and formatted by Carlos Javier Muñoz Crespo, Carmen Ramirez and Daniela Antonova.

This document is one from the series of foreseen documents listed below (at the time of writing, not all documents have been drafted):

Reference Document on Best Available Techniques (BREF)	Code
Ceramic Manufacturing Industry	CER
Common Waste Gas Management and Treatment Systems in the Chemical Sector	WGC
Common Waste Water and Waste Gas Treatment/Management Systems in the Chemical Sector	CWW
Emissions from Storage	EFS
Energy Efficiency	ENE
<i>Ferrous Metals Processing Industry</i>	<i>FMP</i>
Food, Drink and Milk Industries	FDM
Industrial Cooling Systems	ICS
Intensive Rearing of Poultry and Pigs	IRPP
Iron and Steel Production	IS
Large Combustion Plants	LCP
Large Volume Inorganic Chemicals – Ammonia, Acids and Fertilisers Industries	LVIC-AAF
Large Volume Inorganic Chemicals – Solids and Others Industry	LVIC-S
Large Volume Organic Chemical Industry	LVOC
Management of Tailings and Waste-rock in Mining Activities	MTWR
Manufacture of Glass	GLS
Manufacture of Organic Fine Chemicals	OFC
Non-ferrous Metals Industries	NFM
Production of Cement, Lime and Magnesium Oxide	CLM
Production of Chlor-alkali	CAK
Production of Polymers	POL
Production of Pulp, Paper and Board	PP
Production of Speciality Inorganic Chemicals	SIC
Production of Wood-based Panels	WBP
Refining of Mineral Oil and Gas	REF
Slaughterhouses and Animals By-products Industries	SA
Smitheries and Foundries Industry	SF
Surface Treatment of Metals and Plastics	STM
Surface Treatment Using Organic Solvents including Wood and Wood Products Preservation with Chemicals	STS
Tanning of Hides and Skins	TAN
Textiles Industry	TXT
Waste Incineration	WI
Waste Treatment	WT
Reference Document (REF)	
Economics and Cross-media Effects	ECM
Monitoring of Emissions to Air and Water from IED Installations	ROM

Electronic versions of draft and finalised documents are publicly available and can be downloaded from <http://eippcb.jrc.ec.europa.eu>

PREFACE

1 Status of this document

Unless otherwise stated, references to ‘the Directive’ in this document refer to Directive 2010/75/EU of the European Parliament and the Council on industrial emissions (integrated pollution prevention and control) (Recast).

This document is a working draft of the European IPPC Bureau (of the Commission's Joint Research Centre). It is not an official publication of the European Union and does not necessarily reflect the position of the European Commission.

2 Participants in the information exchange

As required in Article 13(3) of the Directive, the Commission has established a forum to promote the exchange of information, which is composed of representatives from Member States, the industries concerned and non-governmental organisations promoting environmental protection (Commission Decision of 16 May 2011 establishing a forum for the exchange of information pursuant to Article 13 of the Directive 2010/75/EU on industrial emissions (2011/C 146/03), OJ C 146, 17.05.2011, p. 3).

Forum members have nominated technical experts constituting the technical working group (TWG) that was the main source of information for drafting this document. The work of the TWG was led by the European IPPC Bureau (of the Commission's Joint Research Centre).

3 Structure and contents of this document

Chapter 1 provides general information on the ferrous metal processing industry (FMP) and on the industrial processes and techniques used within this sector.

Chapters 1 to 6 provide the information given below on specific FMP sectors (i.e. hot rolling, cold rolling, wire drawing, continuous hot dip coating and batch galvanising). For each FMP sector, the chapter is structured as follows (X is the chapter number):

- Section X.1 provides general information on the FMP sector.
- Section X.2 provides information on applied processes and techniques.
- Section X.3 provides data and information concerning the environmental performance of installations within the sector, and in operation at the time of writing, in terms of current emissions, consumption and nature of raw materials, and use of energy.
- Section X.4 describes in more detail the techniques to prevent or, where this is not practicable, to reduce the environmental impact of operating installations in this sector that were considered in determining the BAT. This information includes, where relevant, the environmental performance levels (e.g. emission and consumption levels) which can be achieved by using the techniques, the associated monitoring, the costs and the cross-media issues associated with the techniques.
- Section X.5 presents information on emerging techniques as defined in Article 3(14) of the Directive.

Chapter 7 provides information on the emissions for processes common to more than one sector, i.e. emissions to air from acid recovery and emissions to water from treatment plants processing waste waters that originate from more than one FMP sector. Other streams from non-FMP sectors may be treated together, but the main pollutant load originates from the FMP processes.

Data on emissions to water from plants treating waste waters from only one FMP sector can be found in the respective sector-specific Chapters 1 to 6.

Chapter 8 provides information on the common industrial processes, abatement systems and general techniques that are used across more than one sector in the FMP industry. It describes in more detail the techniques to prevent or, where this is not practicable, to reduce the environmental impact of installations in this sector that were considered in determining the BAT. This information includes, where relevant, the environmental performance levels (e.g. emission and consumption levels) which can be achieved by using the techniques, the associated monitoring and the costs and the cross-media issues associated with the techniques. Sector-specific techniques to consider in the determination of BAT (i.e. those techniques to consider that are applied specifically in one sector) are described in Chapters 1 to 6.

Chapter 9 presents the BAT conclusions as defined in Article 3(12) of the Directive, both general and sector-specific. Chapter 10 is concerned with the concluding remarks and recommendations for future work. Finally, Chapter 11 provides a number of annexes detailing the list of installations who participated to the data collection and other information on specific technical issues.

4 Information sources and the derivation of BAT

This document is based on information collected from a number of sources, in particular through the TWG that was established specifically for the exchange of information under Article 13 of the Directive. The information has been collated and assessed by the European IPPC Bureau (of the Commission's Joint Research Centre) who led the work on determining BAT, guided by the principles of technical expertise, transparency and neutrality. The work of the TWG and all other contributors is gratefully acknowledged.

The BAT conclusions have been established through an iterative process involving the following steps:

- identification of the key environmental issues for the ferrous metal processing industry sectors;
- examination of the techniques most relevant to address these key issues;
- identification of the best environmental performance levels, on the basis of the available data in the European Union and worldwide;
- examination of the conditions under which these environmental performance levels were achieved, such as costs, cross-media effects, and the main driving forces involved in the implementation of the techniques;
- selection of the best available techniques (BAT), their associated emission levels (and other environmental performance levels) and the associated monitoring for this sector according to Article 3(10) of, and Annex III to, the Directive.

Expert judgement by the European IPPC Bureau and the TWG has played a key role in each of these steps and the way in which the information is presented here.

Where available, economic data have been given together with the descriptions of the techniques presented in sections of *Techniques to consider in the determination of BAT*. These data give some indication on the magnitude of the costs and benefits. However, the actual costs and benefits of applying a technique may depend strongly on the specific situation of the installation concerned, which cannot be evaluated fully in this document. In the absence of data concerning costs, conclusions on the economic viability of techniques are drawn from observations on existing installations.

5 Review of BAT reference documents (BREFs)

BAT is a dynamic concept and so the review of BREFs is a continuing process. For example, new measures and techniques may emerge, science and technologies are continuously developing and new or emerging processes are being successfully introduced into the industries. In order to reflect such changes and their consequences for BAT, this document will be periodically reviewed and, if necessary, updated accordingly.

6 Contact information

All comments and suggestions should be made to the European IPPC Bureau at the Joint Research Centre (JRC) at the following address:

European Commission
JRC Directorate B - Growth and Innovation
European IPPC Bureau
Edificio Expo
c/ Inca Garcilaso, 3
E-41092 Seville, Spain
Telephone: +34 95 4488 284
E-mail: JRC-B5-EIPPCB@ec.europa.eu
Internet: <http://eippcb.jrc.ec.europa.eu>

Best Available Techniques Reference Document for the Ferrous Metals Processing Industry

PREFACE	I
SCOPE	XXXV
1 GENERAL INFORMATION ON THE FERROUS METALS PROCESSING INDUSTRY	36
2 HOT ROLLING	39
2.1 GENERAL INFORMATION ON HOT ROLLING	39
2.1.1 Hot rolled flat products	39
2.1.2 Hot rolled long products	40
2.1.3 Hot rolling mill capacity in Europe	41
2.1.4 Hot rolled tubes.....	43
2.2 APPLIED PROCESSES AND TECHNIQUES IN HOT ROLLING	45
2.2.1 Process overview	45
2.2.1.1 Blooming/Slabbing mills	47
2.2.1.2 Hot strip mills	47
2.2.1.3 Plate mills	51
2.2.1.4 Bar and rod mills	52
2.2.1.5 Structural/Section mills	53
2.2.1.6 Tube mills	56
2.2.2 Surface rectification and conditioning of input	58
2.2.3 Reheating and heat treatment furnaces	59
2.2.3.1 Batch furnaces	59
2.2.3.2 Continuous furnaces	60
2.2.4 Descaling	62
2.2.5 Edging	62
2.2.6 Roughing.....	62
2.2.7 Strip rolling / Finishing train	63
2.2.8 Rod rolling / Finishing train.....	63
2.2.9 Plate rolling.....	63
2.2.10 Ring rolling.....	64
2.2.11 Transport of rolling stock between rolling stands.....	64
2.2.12 Cooling lines.....	64
2.2.13 Sheet and plate production.....	65
2.2.14 Plate heat treatment.....	65
2.2.15 Pickling and oiling of hot rolled steel.....	66
2.2.16 Roll shop.....	66
2.2.17 Water circuits / Water management in hot rolling mills.....	66
2.2.18 Waste and by-product management in hot rolling mills	69
2.3 CURRENT CONSUMPTION AND EMISSION LEVELS FOR HOT ROLLING MILLS	71
2.3.1 Mass stream overview	71
2.3.2 Energy consumption	72
2.3.3 Material consumption	79
2.3.3.1 Consumption of oils.....	79
2.3.3.2 Consumption of acids	81
2.3.4 Water consumption	85
2.3.5 Emissions to air.....	87
2.3.5.1 Emissions to air from mechanical processing, scarfing and welding	87

2.3.5.2	Emissions to air from heating.....	87
2.3.5.2.1	Dust emissions	87
2.3.5.2.2	SO ₂ emissions.....	88
2.3.5.2.3	NO _x emissions	88
2.3.5.2.4	CO emissions	96
2.3.5.3	Emissions to air from pickling	96
2.3.5.4	Figures with air emission levels	96
2.3.6	Emissions to water	121
2.3.7	Residues	121
2.4	TECHNIQUES TO CONSIDER IN THE DETERMINATION OF BAT FOR HOT ROLLING	125
2.4.1	Surface rectification and conditioning of input.....	128
2.4.1.1	Enclosed scarfing (other than manual scarfing) combined with air extraction and waste gas treatment	128
2.4.1.2	Enclosed grinding combined with air extraction and waste gas treatment.....	130
2.4.1.3	Computer-aided quality control (CAQC).....	132
2.4.1.4	Edging or trimming of wedge-type slabs	133
2.4.1.5	Slab slitting	133
2.4.2	Reheating and heat treatment furnaces.....	134
2.4.2.1	Process gas management system.....	134
2.4.2.2	Optimised furnace door design	137
2.4.2.3	Regenerative burner	138
2.4.2.4	Recuperative burner	140
2.4.2.5	Oxy-fuel combustion.....	141
2.4.2.6	Flameless combustion	147
2.4.2.7	Pulse-fired burner.....	150
2.4.2.8	Low-NO _x burners	152
2.4.2.9	Selective catalytic reduction (SCR)	153
2.4.2.10	Selective non-catalytic reduction (SNCR)	156
2.4.2.11	Flue-gas recirculation (FGR)	158
2.4.2.12	Optimised skid design to reduce skid marks	159
2.4.2.13	Reduction of energy loss through feedstock transportation device	161
2.4.2.14	Heat recovery from skids cooling	162
2.4.2.15	Heat conservation during transfer of feedstock.....	163
2.4.2.16	Hot/direct charging.....	166
2.4.2.17	Near-net-shape casting for thin slabs followed by rolling.....	169
2.4.2.18	Near-net-shape casting for beam blanks followed by rolling.....	173
2.4.2.19	General techniques to increase energy efficiency of heating and heat recovery techniques from flue gases	174
2.4.3	Descaling.....	175
2.4.3.1	Water spray descaling triggered by sensors	175
2.4.3.2	Use of high-pressure storage equipment	175
2.4.4	Edging	176
2.4.4.1	Sizing press	176
2.4.4.2	Automatic width control comprising short stroke control.....	178
2.4.5	Roughing	179
2.4.5.1	Computer-aided rolling optimisation	179
2.4.6	Transport of rolled stock from roughing mill to finishing train	180
2.4.6.1	Coil boxes	180
2.4.6.2	Coil recovery furnaces	181
2.4.6.3	Strip edge heating.....	182
2.4.7	Rolling.....	182
2.4.7.1	Crop optimisation.....	182
2.4.7.2	Reduction of the rolling friction.....	183
2.4.7.3	Forced interstand strip cooling	184
2.4.7.4	Interstand strip tension control.....	185
2.4.7.5	Strip profile and flatness control	186

2.4.7.6	Work roll cooling.....	187
2.4.7.7	Finishing train automation – process and basic automation	188
2.4.7.8	Air extraction as close as possible to the emission source for mechanical processes and welding combined with waste gas treatment	188
2.4.7.9	Use of water sprays in the case of low levels of dust generation.....	190
2.4.7.10	Hydraulic coilers comprising step control	191
2.4.7.11	Control of the feedstock shape during rolling.....	192
2.4.7.12	On-line heat treatment (accelerated cooling).....	192
2.4.7.13	Thermomechanical rolling operation.....	193
2.4.7.14	Three-roll stand.....	194
2.4.8	Cooling lines	196
2.4.8.1	Optimised water pumps for laminar flows.....	196
2.4.9	Pickling and oiling of hot rolled steel (HRPO).....	197
2.4.10	Roll shop.....	197
2.4.10.1	Recycling of worn working rolls and treatment of grinding sludge	197
2.4.11	Water treatment and waste water generation	199
2.4.11.1	Semi-closed and closed water circuits	199
2.4.11.2	Treatment and reuse of scale- and oil-bearing process water in hot rolling.....	199
2.5	EMERGING TECHNIQUES FOR HOT ROLLING.....	209
2.5.1	Organic Rankine Cycle (ORC) – Heat recovery from the exhaust gases of rolling mill reheating furnaces	209
2.5.2	Electrical welding of billets using water spays and a spark killer device for suppression of fugitive dust emissions	211
3	COLD ROLLING	215
3.1	GENERAL INFORMATION ON COLD ROLLING.....	215
3.1.1	Cold rolled flat products	215
3.2	APPLIED PROCESSES AND TECHNIQUES IN COLD ROLLING.....	217
3.2.1	Process overview	217
3.2.2	Pickling of low-alloy and alloy HR steel.....	219
3.2.3	Annealing (I) and pickling (I) of high-alloy HR steel	220
3.2.4	Cold rolling of the pickled hot rolled strip.....	222
3.2.4.1	Low-alloy and alloy steel.....	222
3.2.4.2	High-alloy steel.....	224
3.2.5	Annealing of low-alloy and alloy steel	225
3.2.5.1	Batch annealing	225
3.2.5.2	Continuous annealing	227
3.2.6	Annealing (II) and pickling (II) of high-alloy steel	228
3.2.7	Tempering of cold rolled strip	229
3.2.7.1	Low-alloy and alloy steel.....	229
3.2.7.2	High-alloy steel.....	230
3.2.8	Finishing	230
3.2.9	Cold pilger mills	231
3.2.10	Roll shop.....	232
3.2.11	Water and process baths management in cold rolling mills.....	232
3.2.11.1	Roll gap lubrication systems: emulsion or pure oil application	232
3.2.11.2	Degreasing solution system	234
3.2.11.3	Cooling water systems.....	234
3.2.11.4	Waste water treatment	236
3.2.12	Waste and by-product management in cold rolling mills	236
3.3	CURRENT CONSUMPTION AND EMISSION LEVELS FOR COLD ROLLING	238
3.3.1	Mass stream overview	238
3.3.2	Energy consumption	239

3.3.3	Material consumption.....	244
3.3.3.1	Consumption of oils	244
3.3.3.2	Consumption of acids.....	246
3.3.4	Water consumption	253
3.3.5	Emissions to air	253
3.3.5.1	Emissions to air from mechanical processing and welding.....	253
3.3.5.2	Emissions to air from heating (annealing)	254
3.3.5.3	Emissions to air from pickling	257
3.3.5.4	Emissions to air from rolling stands and finishing.....	258
3.3.5.5	Figures with air emission concentrations	258
3.3.6	Emissions to water	281
3.3.7	Residues	281
3.4	TECHNIQUES TO CONSIDER IN THE DETERMINATION OF BAT FOR COLD ROLLING ..	282
3.4.1	Pickling	282
3.4.1.1	Laser welding machine	282
3.4.1.2	Air extraction as close as possible to the source for emissions from decoiling and mechanical predescaling	285
3.4.1.3	Hydrochloric acid regeneration by spray roasting.....	286
3.4.1.4	Hydrochloric acid regeneration by fluidised bed	288
3.4.1.5	Effluent-free HCl strip pickling plant	289
3.4.1.6	Sulphuric acid recovery by crystallisation	291
3.4.1.7	Mixed acid (HNO ₃ and HF) regeneration by spray roasting.....	292
3.4.1.8	Mixed acid (HNO ₃ and HF) recovery by ion exchange	294
3.4.1.9	Mixed acid (HNO ₃ and HF) recovery by diffusion dialysis.....	295
3.4.1.10	Mixed acid (HNO ₃ and HF) recovery by evaporation.....	296
3.4.1.11	Magnetic pumps (low-alloy and alloy steel)	297
3.4.1.12	Treatment of acidic waste water.....	298
3.4.1.13	Three-acid pickling for stainless steel.....	300
3.4.1.14	Chemical reduction of hexavalent Cr(VI) with sulphur dioxide	301
3.4.2	Rolling.....	302
3.4.2.1	Continuous rolling for low-alloy and alloy steel	302
3.4.2.2	Pickling plant coupled with the tandem mill	303
3.4.2.3	Optimal choice of rolling oil and emulsion system.....	304
3.4.2.4	Reduction of the rolling friction.....	305
3.4.2.5	Monitoring and adjustment of the rolling emulsion quality	305
3.4.2.6	Prevention of contamination of the rolling emulsion	306
3.4.2.7	Minimisation of oil/rolling emulsion consumption.....	308
3.4.2.8	Cleaning and reuse of the rolling emulsion.....	308
3.4.2.9	Treatment of spent rolling emulsion	310
3.4.2.10	Air extraction as close as possible to the source for emissions from rolling.....	313
3.4.3	Annealing	314
3.4.3.1	Reverse cascade degreasing	314
3.4.3.2	Hot water pre-degreasing	315
3.4.3.3	Regenerative or recuperative burners for annealing furnaces	316
3.4.3.4	Low-NO _x burner for annealing furnaces	317
3.4.3.5	Selective catalytic reduction (SCR) in continuous annealing lines	318
3.4.3.6	Heat recovery for heating the degreasing bath.....	321
3.4.4	Tempering	322
3.4.4.1	Optimisation of wet temper rolling emulsion application systems	322
3.4.4.2	Dry tempering and low-volume lubrication in wet tempering	323
3.4.4.3	Cleaning of temper mill emulsion.....	324
3.4.4.4	Air extraction as close as possible to the source for emissions from wet tempering	325
3.4.4.5	Air extraction and abatement in dry tempering.....	326
3.4.5	Finishing.....	327

3.4.5.1	Air extraction as close as possible to the source.....	327
3.4.5.2	Air extraction as close as possible to the source for emissions from levelling and welding.....	328
3.4.6	Roll shop.....	329
3.4.6.1	Cleaning and reuse of grinding emulsion	329
3.4.6.2	Texturing of work rolls.....	330
3.5	EMERGING TECHNIQUES FOR COLD ROLLING.....	333
3.5.1	Organic Rankine Cycle (ORC) – Heat recovery from excess energy from coils in batch annealing furnaces	333
4	WIRE DRAWING	335
4.1	GENERAL INFORMATION ON WIRE DRAWING	335
4.2	APPLIED PROCESSES AND TECHNIQUES IN WIRE DRAWING.....	336
4.2.1	Wire drawing process overview	336
4.2.2	Wire rod preparation.....	337
4.2.2.1	Mechanical descaling of wire rod	338
4.2.2.2	Chemical descaling (pickling) of wire rod.....	338
4.2.2.3	Application of soap (lubricant) carrier.....	338
4.2.3	Drawing	339
4.2.3.1	Dry drawing of wire.....	339
4.2.3.2	Wet drawing of wire	339
4.2.4	Heat treatment of wire	339
4.2.4.1	Batch annealing of low-carbon steel wire.....	339
4.2.4.2	Continuous (in-line) annealing of low-carbon steel wire.....	340
4.2.4.3	Continuous (in-line) annealing of stainless steel wire	340
4.2.4.4	Patenting	340
4.2.4.5	Oil hardening and tempering (oil tempering)	341
4.2.4.6	Stress-relieving	341
4.2.5	In-line pickling.....	341
4.3	CURRENT CONSUMPTION AND EMISSION LEVELS FOR WIRE DRAWING.....	343
4.3.1	Mass stream overview	343
4.3.2	Energy consumption	344
4.3.3	Material consumption	344
4.3.3.1	Consumption of acids	344
4.3.4	Water consumption.....	344
4.3.5	Emissions to air.....	344
4.3.5.1	Emissions to air from dry drawing	344
4.3.5.2	Emissions to air from heating	344
4.3.5.3	Emissions to air from pickling.....	345
4.3.6	Emissions to water	346
4.3.7	Residues	346
4.3.8	Figures with consumption and emission levels	348
4.4	TECHNIQUES TO CONSIDER IN THE DETERMINATION OF BAT FOR WIRE DRAWING .	356
4.4.1	Mechanical descaling.....	356
4.4.1.1	Recycling of scale.....	356
4.4.1.2	Recovery and reuse of shot blast media.....	357
4.4.2	Chemical descaling / Pickling of wire rod.....	359
4.4.2.1	Control of pickling emissions	359
4.4.2.2	Acid recovery	359
4.4.2.3	Reuse of spent acid as secondary raw material.....	359
4.4.3	Dry drawing	360
4.4.3.1	Enclosed drawing machine combined with air extraction and abatement	360

4.4.3.2	Air extraction as close as possible to the emission source for emissions from the drawing machine	361
4.4.3.3	Closed loop for cooling water	361
4.4.3.4	Use of low-borax drawing soaps	362
4.4.4	Wet drawing	363
4.4.4.1	Closed loop for cooling water	363
4.4.4.2	Cleaning of drawing lubricant / coolant	363
4.4.4.3	Treatment of waste drawing lubricant: oil and oil emulsions.....	364
4.4.4.4	Treatment and disposal of waste drawing lubricant: soap emulsions.....	365
4.4.5	Batch annealing of wire.....	365
4.4.5.1	Burn purge of protective gas	365
4.4.6	Continuous (in-line) annealing of low-carbon wire	366
4.4.6.1	Floating protective layers or tank covers on the surface of the lead baths	366
4.4.6.2	Minimisation of carry-over of lead	367
4.4.6.3	Air extraction as close as possible to the source and treatment of lead bath emissions	368
4.4.6.4	Closed-loop operation of quench bath and waste water treatment	368
4.4.7	Patenting	369
4.4.7.1	Optimised operation of the oven	369
4.4.8	Oil hardening and tempering.....	370
4.4.8.1	Burn purge of protective gas	370
4.4.8.2	Air extraction as close as possible to the emission source for emissions from oil quench baths.....	370
4.4.9	Heat treatment of wire (different processes)	371
4.4.9.1	Inductive heating of wire.....	371
4.4.10	In-line pickling	372
4.5	EMERGING TECHNIQUES FOR WIRE DRAWING	373
5	CONTINUOUS HOT DIP COATING.....	375
5.1	GENERAL INFORMATION ON CONTINUOUS HOT DIP COATING	375
5.2	APPLIED PROCESSES AND TECHNIQUES IN CONTINUOUS HOT DIP COATING.....	376
5.2.1	Continuous hot dip coating process overview.....	376
5.2.2	Galvanising of sheet (zinc and zinc alloy coating).....	377
5.2.2.1	Pickling	377
5.2.2.2	Degreasing	378
5.2.2.3	Heat treatment	379
5.2.2.4	Hot dipping (galvanising).....	380
5.2.2.5	Galvannealing	381
5.2.2.6	Finishing.....	382
5.2.2.7	Post-treatments.....	383
5.2.2.8	Cooling water circuits	384
5.2.2.9	Water circuits / Water management	387
5.2.3	Aluminising of sheet	388
5.2.4	Wire hot dip coating.....	389
5.2.4.1	Continuous pickling of wire.....	389
5.2.4.2	Fluxing	389
5.2.4.3	Hot dipping (galvanising of wire)	390
5.2.4.4	Finishing of wire	390
5.3	CURRENT CONSUMPTION AND EMISSION LEVELS FOR CONTINUOUS HOT DIP COATING	391
5.3.1	Continuous coating mass stream overview	391
5.3.2	Energy consumption.....	392
5.3.3	Material consumption.....	394
5.3.3.1	Consumption of oils	394

5.3.3.2	Consumption of acids	394
5.3.4	Water consumption	396
5.3.5	Emissions to air	396
5.3.5.1	Emissions to air from heating	396
5.3.5.2	Emissions to air from degreasing	398
5.3.5.3	Emissions to air from pickling	399
5.3.5.4	Figures with air emission levels	399
5.3.6	Emissions to water	407
5.3.7	Residues	407
5.4	TECHNIQUES TO CONSIDER IN THE DETERMINATION OF BAT FOR CONTINUOUS HOT DIP COATING	408
5.4.1	Galvanising of sheet	408
5.4.1.1	Degreasing	408
5.4.1.1.1	Reverse cascade degreasing	408
5.4.1.1.2	Cleaning and reuse of the degreasing solution	409
5.4.1.1.3	Use of a direct-flame furnace in the case of hot dip coating of steel sheets	410
5.4.1.1.4	Squeeze rolls	412
5.4.1.2	Heat treatment	413
5.4.1.2.1	Inductive heating system	413
5.4.1.3	Hot dipping (galvanising)	414
5.4.1.3.1	Air knives for coating thickness control	414
5.4.1.3.2	Stabilisation of the strip	415
5.4.1.4	Galvannealing	417
5.4.1.4.1	Galvannealing treatment tower equipped with induction heating	417
5.4.1.5	Post-treatments	420
5.4.1.5.1	Cleaning and reuse of the phosphating or passivation solution	420
5.4.1.5.2	Air extraction as close as possible to the source from chemical baths or tanks in post-treatment (i.e. phosphating and passivation)	421
5.4.1.5.3	Closed tanks combined with air extraction in the case of continuous post- treatment	422
5.4.1.5.4	Minimisation of drag-out of chemical solution	423
5.4.1.5.5	Use of roll coaters for strips	424
5.4.1.5.6	Avoiding the use of hexavalent chromium compounds in passivation – use of other metal-containing solutions	426
5.4.1.5.7	Avoiding the use of hexavalent chromium compounds in passivation – use of organic polymer solutions	428
5.4.1.6	Finishing	429
5.4.1.6.1	Collection and treatment of temper mill emulsion	429
5.4.1.7	Waste water treatment in galvanising line	429
5.4.2	Aluminising and lead-tin (terne) coating of sheets	429
5.4.3	Wire hot dip coating (galvanising)	430
5.4.3.1	Fluxing	430
5.4.3.1.1	Covered flux bath	430
5.4.3.2	Hot dipping (galvanising of wire)	430
5.4.3.2.1	Zinc bath: good housekeeping	430
5.4.3.2.2	Emission capture and treatment of extracted air	431
5.4.3.2.3	Air or nitrogen wiping	432
5.4.3.2.4	Mechanical wiping	432
5.5	EMERGING TECHNIQUES FOR CONTINUOUS HOT DIP COATING	434
5.5.1	Jet vapour deposition	434
6	BATCH GALVANISING	437
6.1	GENERAL INFORMATION ON BATCH GALVANISING	437
6.2	APPLIED PROCESSES AND TECHNIQUES IN BATCH GALVANISING	439
6.2.1	Batch hot dip coating overview	439

6.2.2	Raw material handling	441
6.2.3	Preparation of the input	441
6.2.4	Degreasing.....	441
6.2.5	Pickling	442
6.2.5.1	HCl pickling	442
6.2.5.2	H ₂ SO ₄ pickling	442
6.2.6	Stripping	443
6.2.7	Rinsing	443
6.2.8	Fluxing	443
6.2.9	Hot dipping.....	444
6.2.10	Finishing and post-treatment.....	446
6.3	CURRENT CONSUMPTION AND EMISSION LEVELS FOR BATCH GALVANISING.....	447
6.3.1	Batch galvanising mass stream overview.....	447
6.3.2	Energy consumption.....	448
6.3.3	Material consumption.....	449
6.3.4	Water consumption	451
6.3.5	Emissions to air	451
6.3.5.1	Emissions to air from heating and feedstock drying	451
6.3.5.2	Emissions to air from pickling	452
6.3.5.3	Emissions to air from hot dipping	452
6.3.6	Residues	453
6.3.7	Figures with consumption and emission levels	456
6.4	TECHNIQUES TO CONSIDER IN THE DETERMINATION OF BAT FOR BATCH GALVANISING.....	476
6.4.1	Degreasing.....	476
6.4.1.1	Slow lifting of workpieces	476
6.4.1.2	Biological treatment of the degreasing bath ('biological degreasing').....	477
6.4.2	Pickling and stripping.....	479
6.4.2.1	Separate pickling and stripping	479
6.4.2.2	Evaporative recovery (HCl)	480
6.4.2.3	Zinc removal by ion exchange	481
6.4.2.4	Iron removal by oxidation and precipitation	483
6.4.2.5	Zinc removal by solvent extraction	483
6.4.2.6	Restricted operating range for hydrochloric acid open pickling baths	486
6.4.2.7	Extraction by lateral hood or lip extraction.....	488
6.4.2.8	Enclosed pretreatment section with extraction.....	490
6.4.3	Rinsing	493
6.4.4	Fluxing	493
6.4.5	Hot dipping.....	493
6.4.5.1	Optimised dipping time	493
6.4.5.2	Slow withdrawal of workpieces from the bath.....	494
6.4.5.3	Modified fluxing solution to increase the aluminium content of the bath.....	494
6.4.5.4	Recovery and use of zinc-containing particles from steam blow-off (tube finishing)	495
6.4.5.5	Thin film coating in batch galvanising.....	496
6.4.6	Emissions to water	497
6.4.6.1	Waste water discharge in batch galvanising.....	497
6.5	EMERGING TECHNIQUES FOR BATCH GALVANISING.....	498
7	CURRENT CONSUMPTION AND EMISSION LEVELS FOR PROCESSES COMMON TO MORE THAN ONE SECTOR.....	499
7.1	ACID RECOVERY	499
7.1.1	Emissions to air	499

7.2	WASTE WATER TREATMENT OF STREAMS FROM MORE THAN ONE SECTOR.....	506
7.2.1	Emissions to water.....	506
8	TECHNIQUES TO CONSIDER IN THE DETERMINATION OF BAT IN MORE THAN ONE SECTOR	549
8.1	ENVIRONMENTAL MANAGEMENT TECHNIQUES	549
8.1.1	Environmental management system (EMS)	549
8.1.2	Inventory of process chemicals used and of waste water and waste gas streams	552
8.1.3	Chemicals management system (CMS).....	553
8.2	MONITORING.....	555
8.2.1	Overview.....	555
8.2.2	Monitoring of emissions to water	555
8.2.3	Monitoring of channelled emissions to air.....	556
8.3	GENERAL ENVIRONMENTAL PERFORMANCE.....	558
8.3.1	Set-up and implementation of a plan for the prevention and control of leaks and spillages.....	558
8.3.2	Use of oil-tight trays or cellars	559
8.3.3	Prevention and handling of acid spillages and leaks	560
8.3.4	Techniques for storage and handling of coils	560
8.3.5	Set-up and implementation of an OTNOC management plan to reduce emissions during OTNOC	564
8.4	HAZARDOUS SUBSTANCES	567
8.4.1	Avoiding the use of hexavalent chromium compounds in passivation.....	567
8.5	ENERGY EFFICIENCY	568
8.5.1	Energy efficiency plan and energy audits.....	568
8.5.2	Energy balance record	569
8.5.3	General techniques to increase the energy efficiency of heating.....	570
8.5.3.1	Optimum furnace design for feedstock heating	570
8.5.3.2	Combustion optimisation.....	572
8.5.3.3	Furnace automation and control	572
8.5.3.4	Process gas management system	574
8.5.3.5	Batch annealing with 100 % hydrogen	575
8.5.3.6	Optimum galvanising kettle design	578
8.5.3.7	Optimum galvanising kettle operation.....	579
8.5.4	General heat recovery techniques from flue-gases	580
8.5.4.1	Feedstock preheating	580
8.5.4.2	Drying of workpieces	582
8.5.4.3	Preheating of combustion air	583
8.5.4.4	Waste heat recovery boiler	588
8.6	MATERIAL EFFICIENCY	591
8.6.1	Techniques to increase material efficiency in degreasing	591
8.6.1.1	Use of feedstock with low oil and grease contamination.....	591
8.6.1.2	General techniques for increased degreasing efficiency	591
8.6.1.3	Minimisation of drag-out of degreasing solution.....	592
8.6.1.4	Reverse cascade degreasing.....	592
8.6.1.5	Cleaning and reuse of the degreasing solution.....	592
8.6.2	Techniques to increase material efficiency in pickling.....	595
8.6.2.1	Acid heating with heat exchangers or by submerged combustion	595
8.6.2.2	Minimisation of steel corrosion	597
8.6.2.3	Mechanical predescaling	598
8.6.2.4	Electrolytic prepickling for high-alloy steel	599

8.6.2.5	Rinsing after alkaline degreasing	600
8.6.2.6	General techniques for increased pickling efficiency.....	601
8.6.2.7	Cleaning of the pickling bath and reuse of free acid	602
8.6.2.8	Reverse cascade pickling	602
8.6.2.9	Minimisation of drag-out of pickling acid	603
8.6.2.10	Turbulence pickling	604
8.6.2.11	Use of pickling inhibitors.....	605
8.6.2.12	Activated pickling in hydrochloric acid pickling	606
8.6.3	Techniques to increase material efficiency in fluxing.....	608
8.6.3.1	Rinsing of workpieces after pickling.....	608
8.6.3.2	Optimised fluxing operation.....	610
8.6.3.3	Iron removal and reuse of the fluxing solution	611
8.6.3.4	Recovery of salts from the spent fluxing solution for production of fluxing agents	616
8.6.3.5	Minimisation of drag-out of fluxing solution.....	616
8.6.4	Techniques to increase material efficiency in hot dipping.....	617
8.6.4.1	Reduction of the generation of bottom dross	617
8.6.4.2	Prevention, collection and reuse of zinc splashes in batch galvanising.....	618
8.6.4.3	Reduction of the generation of zinc ash	618
8.6.5	Techniques to recover spent pickling acids.....	619
8.7	WATER USE AND WASTE WATER GENERATION.....	633
8.7.1	Water management plan and water audits.....	633
8.7.2	Segregation of water streams	634
8.7.3	Minimisation of hydrocarbon contamination of process water	635
8.7.4	Reuse and/or recycling of water.....	636
8.7.5	Reverse cascade rinsing	637
8.7.6	Recycling or reuse of rinsing water.....	640
8.7.7	Cooling water systems	641
8.8	GENERAL TECHNIQUES TO REDUCE EMISSIONS TO AIR	644
8.8.1	End-of-pipe techniques	644
8.8.1.1	Demister.....	644
8.8.1.2	Electrostatic precipitator (ESP).....	644
8.8.1.3	Fabric filter.....	644
8.8.1.4	Selective catalytic reduction (SCR)	644
8.8.1.5	Selective non-catalytic reduction (SNCR)	645
8.8.1.6	Optimisation of the SNCR/SCR design and operation.....	646
8.8.1.7	Wet scrubbing	648
8.8.2	Emissions to air from heating.....	648
8.8.2.1	Use of electricity generated from fossil-free energy sources for heating	648
8.8.2.2	Use of fuels with low dust or ash content	651
8.8.2.3	Limiting the entrainment of dust.....	651
8.8.2.4	Use of a fuel or a combination of fuels with low sulphur content.....	652
8.8.2.5	Use of a fuel or a combination of fuels with low NO _x formation potential	652
8.8.2.6	Furnace automation and control.....	653
8.8.2.7	Combustion optimisation	653
8.8.2.8	Low-NO _x burner.....	653
8.8.2.9	Flue-gas recirculation.....	656
8.8.2.10	Limiting the temperature of air preheating.....	658
8.8.2.11	Flameless combustion	661
8.8.2.12	Oxy-fuel combustion.....	661
8.8.2.13	Selective catalytic reduction (SCR)	661
8.8.2.14	Selective non-catalytic reduction (SNCR)	662
8.8.3	Emissions to air from degreasing	662
8.8.3.1	Closed degreasing tanks combined with air extraction in the case of continuous degreasing	662

8.8.3.2	Emissions to air from degreasing operations in batch galvanising	663
8.8.4	Emissions to air from pickling in HR, CR, HDC and WD	664
8.8.4.1	Batch pickling in tanks equipped with lids or enclosing hoods combined with fume extraction	664
8.8.4.2	Continuous pickling in closed tanks combined with fume extraction	666
8.8.4.3	Wet scrubbing followed by a demister	667
8.8.5	NO _x reduction techniques in mixed acid pickling	674
8.8.5.1	Nitric-acid free pickling of high-alloy steel.....	675
8.8.5.2	Addition of hydrogen peroxide or urea to the pickling acid	676
8.8.5.3	Wet scrubbing with addition of an oxidising agent (e.g. hydrogen peroxide)	680
8.8.5.4	Selective catalytic reduction (SCR) in mixed acid pickling	681
8.8.5.5	Comparison of NO _x reduction methods for mixed acid pickling.....	682
8.8.6	Emissions to air from hot dipping.....	684
8.8.6.1	Low-fume flux.....	684
8.8.6.2	Minimisation of carry-over of the fluxing solution	686
8.8.6.3	Air extraction as close as possible to the source.....	686
8.8.6.4	Enclosed kettles combined with air extraction	689
8.8.7	Emissions to air from oiling.....	691
8.8.7.1	Electrostatic oiling.....	691
8.8.7.2	Enclosed oiling machine with air extraction followed by a demister	693
8.8.7.3	Contact lubrication	693
8.8.7.4	Oiling without compressed air.....	694
8.8.8	Emissions to air from acid recovery	695
8.8.8.1	Use of a fuel or a combination of fuels with low sulphur content and/or low NO _x formation potential	695
8.8.8.2	Furnace automation and control	695
8.8.8.3	Combustion optimisation.....	695
8.8.8.4	Low-NO _x burners.....	695
8.8.8.5	Wet scrubbing followed by a demister	696
8.8.8.6	Selective catalytic reduction (SCR).....	696
8.9	GENERAL TECHNIQUES TO REDUCE EMISSIONS TO WATER	697
8.9.1	Adsorption	697
8.9.2	Aerobic treatment	697
8.9.3	Chemical precipitation.....	697
8.9.4	Chemical reduction.....	697
8.9.5	Coagulation and flocculation.....	697
8.9.6	Equalisation	698
8.9.7	Filtration	698
8.9.8	Flotation.....	698
8.9.9	Nanofiltration.....	698
8.9.10	Neutralisation.....	698
8.9.11	Physical separation	699
8.9.12	Reverse osmosis.....	699
8.9.13	Sedimentation	699
8.9.14	Treatment of water contaminated with oil or grease	699
8.10	GENERAL TECHNIQUES TO REDUCE NOISE AND VIBRATIONS.....	705
8.10.1	Noise and vibration management plan.....	705
8.10.2	Appropriate location of equipment and buildings	705
8.10.3	Operational measures.....	705
8.10.4	Low-noise equipment	705
8.10.5	Noise and vibration control equipment.....	706
8.10.6	Noise abatement.....	706

8.11	RESIDUES	707
8.11.1	General techniques for residues management	707
8.11.1.1	Residues management plan	707
8.11.1.2	Pretreatment of oily mill scale for further use.....	707
8.11.1.3	Use of mill scale.....	711
8.11.1.4	Use of metallic scrap.....	711
8.11.1.5	Recycling of metal and metal oxides from dry waste gas cleaning.....	712
8.11.1.6	Use of oily sludge.....	712
8.11.1.7	Thermal treatment of hydroxide sludge from the recovery of mixed acid	713
8.11.2	Techniques for residues management in galvanising	715
8.11.2.1	Recycling of fabric filter dust.....	715
8.11.2.2	Recycling of zinc ash and top dross.....	715
8.11.2.3	Recycling of bottom dross.....	716
8.11.2.4	Environmental risk prevention from the storage of zinc-containing residues	717
8.11.3	Techniques for residues management in wire drawing	717
8.11.3.1	Environmental risk prevention from the storage of lead-containing residues	717
8.11.3.2	Recycling of lead-containing residues from wire drawing	718
9	BEST AVAILABLE TECHNIQUES (BAT) CONCLUSIONS FOR THE FERROUS METALS PROCESSING INDUSTRY.....	721
9.1	SCOPE	721
9.2	DEFINITIONS	723
9.3	ACRONYMS	726
9.4	GENERAL CONSIDERATIONS	727
9.4.1	Best Available Techniques.....	727
9.4.2	BAT-AELs and indicative emission levels for emissions to air.....	727
9.4.3	BAT-AELs for emissions to water	728
9.4.4	Other environmental performance levels associated with the best available techniques (BAT-AEPLs)	729
9.4.4.1	BAT-AEPLs for specific energy consumption (energy efficiency)	729
9.4.4.2	BAT-AEPLs for specific water consumption.....	729
9.4.4.3	BAT-AEPLs for specific material consumption	729
9.5	GENERAL BAT CONCLUSIONS FOR THE FERROUS METALS PROCESSING INDUSTRY	730
9.5.1	General environmental performance	730
9.5.2	Monitoring.....	734
9.5.3	Hazardous substances.....	739
9.5.4	Energy efficiency	739
9.5.5	Material efficiency	743
9.5.6	Water use and waste water generation	748
9.5.7	Emissions to air	749
9.5.7.1	Emissions to air from heating.....	749
9.5.7.2	Emissions to air from degreasing	753
9.5.7.3	Emissions to air from pickling	754
9.5.7.4	Emissions to air from hot dipping	756
9.5.7.5	Emissions to air from oiling	757
9.5.7.6	Emissions to air from post-treatment	757
9.5.7.7	Emissions to air from acid recovery.....	758
9.5.8	Emissions to water	759
9.5.9	Noise and vibrations.....	761
9.5.10	Residues	763
9.6	BAT CONCLUSIONS FOR HOT ROLLING.....	765
9.6.1	Energy efficiency	765
9.6.2	Material efficiency	767

9.6.3	Emissions to air.....	768
9.7	BAT CONCLUSIONS FOR COLD ROLLING	769
9.7.1	Energy efficiency.....	769
9.7.2	Material efficiency.....	770
9.7.3	Emissions to air.....	770
9.8	BAT CONCLUSIONS FOR WIRE DRAWING	772
9.8.1	Energy efficiency.....	772
9.8.2	Material efficiency.....	772
9.8.3	Emissions to air.....	772
9.8.4	Residues.....	773
9.9	BAT CONCLUSIONS FOR HOT DIP COATING OF SHEETS AND WIRES	774
9.9.1	Material efficiency.....	774
9.10	BAT CONCLUSIONS FOR BATCH GALVANISING.....	775
9.10.1	Residues.....	775
9.10.2	Material efficiency.....	775
9.10.3	Emissions to air.....	776
9.10.4	Waste water discharge	777
9.11	DESCRIPTIONS OF TECHNIQUES.....	778
9.11.1	Techniques to increase energy efficiency.....	778
9.11.2	Techniques to reduce emissions to air	779
9.11.3	Techniques to reduce emissions to water.....	780
10	CONCLUDING REMARKS AND RECOMMENDATIONS FOR FUTURE WORK	781
11	ANNEXES	789
11.1	LIST OF INSTALLATIONS/PLANTS THAT PARTICIPATED IN THE 2018 DATA COLLECTION FOR THE FMP BREF REVIEW.....	789
11.2	EXPLANATION OF EMISSION POINT IDENTIFICATION.....	798
11.3	INFORMATION ON STEEL GRADE, STEEL CATEGORY AND STEEL PRODUCTS IN THE FMP INDUSTRIAL SECTOR.....	801
11.3.1	Steel grades.....	801
11.3.2	Steel products.....	802
11.4	INFORMATION ON THE REPORTED USE OF BAT IN THE VARIOUS FMP INDUSTRIAL SECTORS	804
11.5	COMBUSTION PROCESS(ES) WHEN USING OXYGEN-ENRICHED AIR OR PURE OXYGEN: NORMALISATION BASED ON THE CARBON DIOXIDE GENERATED DURING THE COMBUSTION.....	815
11.6	EXAMPLES OF CALCULATION OF SPECIFIC ENERGY CONSUMPTION FOR REHEATING, INTERMEDIATE HEATING AND POST-HEATING PROCESSES IN HOT ROLLING.....	817
11.7	EXAMPLE OF CALCULATION OF THE AVERAGE YEARLY PRODUCTION THROUGHPUT IN BATCH GALVANISING	821
11.8	EXAMPLES OF CALCULATION OF SPECIFIC MATERIAL CONSUMPTION	822
11.9	COMPARISON OF NO _x REDUCTION METHODS FOR FURNACES	823
	GLOSSARY.....	825
I	ISO COUNTRY CODES	825
II.	MONETARY UNITS	826
III.	UNIT AND MEASUREMENTS.....	827
IV.	ACRONYMS.....	828
V.	ABBREVIATIONS.....	829

REFERENCES.....	835
------------------------	------------

List of figures

Figure 1.1:	Hot and cold formed products covered by this BREF.....	36
Figure 2.1:	Overview of hot rolled products.....	46
Figure 2.2:	Typical designs for hot strip mills.....	48
Figure 2.3:	Hot strip production with two thin slab casters, two reheating furnaces and one finishing mill; capacity 2 Mt/yr.....	49
Figure 2.4:	Hot strip production with two thin slab casters, two reheating furnaces, one continuous roughing mill, bar heater and finishing mill; capacity 3 Mt/yr.....	49
Figure 2.5:	Hot strip production with one thin slab caster directly coupled with one continuous roughing mill, inductive bar heater and endless or semi-endless finishing mill; capacity 2 Mt/yr	50
Figure 2.6:	Typical Steckel mill configuration	50
Figure 2.7:	Steckel mill with coiling furnaces	51
Figure 2.8:	Typical plate mill configuration with one 4-high horizontal rolling stand.....	51
Figure 2.9:	Typical layout of a wire rod mill.....	52
Figure 2.10:	Profiled rolls for sheet piling sections.....	54
Figure 2.11:	Universal stands for parallel flanged product.....	54
Figure 2.12:	Plant layout of a heavy section mill	55
Figure 2.13:	Plant layout of a heavy/medium section mill for sheet piling	55
Figure 2.14:	Examples of beam blanks' cross sections	56
Figure 2.15:	Medium section mill fed by cast beam blanks	56
Figure 2.16:	Mandrel mill.....	57
Figure 2.17:	Plug mill.....	58
Figure 2.18:	Pit furnace	60
Figure 2.19:	Pusher-type furnace.....	60
Figure 2.20:	Walking beam furnace	61
Figure 2.21:	Typical design of a rotary hearth furnace.....	61
Figure 2.22:	Roller arrangement of wire rod finishing section.....	63
Figure 2.23:	Material cut into blanks after heating in an induction furnace and blanks heated in a batch furnace after cutting cold.....	64
Figure 2.24:	Blanks pierced, pressed and rolled in a radial rolling mill and in an axial rolling mill.....	64
Figure 2.25:	Different types of water cooling.....	65
Figure 2.26:	Example of a once-through water system	66
Figure 2.27:	Example of a semi-closed water circuit	67
Figure 2.28:	Example of a closed water circuit	68
Figure 2.29:	Water loops for hot strip rolling mill.....	68
Figure 2.30:	Use of water loops in a hot rolling mill.....	69
Figure 2.31:	Input/output overview for hot rolling mills	71
Figure 2.32:	Specific energy consumption (MJ/t of feedstock processed) for feedstock reheating.....	75
Figure 2.33:	Specific energy consumption (MJ/t of feedstock processed) for feedstock intermediate heating.....	76
Figure 2.34:	Specific energy consumption (MJ/t of feedstock processed) for feedstock post-heating.....	77
Figure 2.35:	Specific energy consumption (MJ/t of feedstock processed) for rolling processes.....	78
Figure 2.36:	Specific oil consumption (kg/t of production) in hot rolling plants	80
Figure 2.37:	Specific HCl consumption (kg/m ² of treated surface) in HRPO plants.....	82
Figure 2.38:	Specific H ₂ SO ₄ consumption (kg/m ² of treated surface) in HRPO plants.....	83
Figure 2.39:	Specific HF/HNO ₃ consumption (kg/m ² of treated surface) in HRPO plants	84
Figure 2.40:	Specific water consumption (m ³ /t of production) in hot rolling plants	86
Figure 2.41:	NO _x emissions and air preheating temperature for a post-heating treatment furnace at SSAB Oxelösund, Sweden.....	89
Figure 2.42:	NO _x emissions and air preheating temperature	90
Figure 2.43:	Effect of fuel type on flame temperature.....	91
Figure 2.44:	NO _x emission concentrations as a function of the type of fuels used in the reheating furnace (COG and HFO).....	91
Figure 2.45:	Continuously measured NO _x emission concentrations for pusher-type furnaces at Tata Steel IJmuiden (Plant 110 HR2-1) showing NO _x fluctuations over a year.....	92
Figure 2.46:	Continuously measured NO _x emission concentrations at two walking beam furnaces from Tata Steel IJmuiden (Plant 110 HR2-2) showing NO _x fluctuation over a year.....	93
Figure 2.47:	Dust emissions from mechanical processing, scarfing and welding (in mg/Nm ³) - Part 1 of 2	98
Figure 2.48:	Dust emissions from mechanical processing, scarfing and welding (in mg/Nm ³) - Part 2 of 2	99

Figure 2.49:	Lead emissions from mechanical processing, scarfing and welding (in mg/Nm ³)	100
Figure 2.50:	Nickel emissions from mechanical processing, scarfing and welding (in mg/Nm ³).....	101
Figure 2.51:	Dust emissions from feedstock heating (in mg/Nm ³ at 3 % oxygen) for 100% natural gas.....	102
Figure 2.52:	Dust emissions from feedstock heating (in mg/Nm ³ at 3 % oxygen) for fuels other than 100 % natural gas	103
Figure 2.53:	SO ₂ emissions from feedstock heating (in mg/Nm ³ at 3 % oxygen) for 100 % natural gas.....	104
Figure 2.54:	SO ₂ emissions from feedstock heating (in mg/Nm ³ at 3 % oxygen) for fuels other than 100 % natural gas	105
Figure 2.55:	NO _x emissions from reheating (in mg/Nm ³ at 3 % oxygen) for 100 % natural gas – Part 1 of 2.....	106
Figure 2.56:	NO _x emissions from reheating (in mg/Nm ³ at 3 % oxygen) for 100 % natural gas – Part 2 of 2.....	107
Figure 2.57:	NO _x emissions from intermediate and post-heating (in mg/Nm ³ at 3 % oxygen) for 100 % natural gas	108
Figure 2.58:	NO _x emissions from reheating intermediate and post-heating (in mg/Nm ³ at 3 % oxygen) for fuels other than 100 % natural gas	109
Figure 2.59:	NO _x emissions from reheating (in mg/Nm ³ at 3 % oxygen) for 100 % natural gas for reheating of flat products.....	110
Figure 2.60:	NO _x emissions from reheating (in mg/Nm ³ at 3 % oxygen) for fuels other than 100 % natural gas for reheating of flat products	111
Figure 2.61:	NO _x emissions from reheating, intermediate and post-heating (in mg/Nm ³ at 3 % oxygen) for 100 % natural gas, without air preheating	112
Figure 2.62:	NO _x emissions from reheating, intermediate and post-heating (in mg/Nm ³ at 3 % oxygen) for fuels other than 100 % natural gas, without air preheating	113
Figure 2.63:	NO _x emissions from reheating (in mg/Nm ³ at 3 % oxygen) for 100 % natural gas, with air preheating temperature and feedstock target temperature – Part 1 of 2.....	114
Figure 2.64:	NO _x emissions from reheating (in mg/Nm ³ at 3 % oxygen) for 100 % natural gas, with air preheating temperature and feedstock target temperature – Part 2 of 2.....	115
Figure 2.65:	NO _x emissions from intermediate and post-heating (in mg/Nm ³ at 3 % oxygen) for 100 % natural gas, with air preheating temperature and feedstock target temperature.....	116
Figure 2.66:	NO _x emissions from reheating and post-heating (in mg/Nm ³ at 3 % oxygen) for fuels other than 100 % natural gas, with air preheating temperature and feedstock target temperature	117
Figure 2.67:	CO emissions from reheating (in mg/Nm ³ at 3 % oxygen) for 100 % natural gas	118
Figure 2.68:	CO emissions from intermediate and post-heating (in mg/Nm ³ at 3 % oxygen) for 100 % natural gas	119
Figure 2.69:	CO emissions from reheating and post-heating (in mg/Nm ³ at 3 % oxygen) for fuels other than 100 % natural gas.....	120
Figure 2.70:	Specific generation of oil-containing residues (in kg/t).....	122
Figure 2.71:	Specific generation of scale (in kg/t)	123
Figure 2.72:	Specific generation of filter dust (in kg/t).....	124
Figure 2.73:	Scarfing abatement flowsheet (example with wet EP)	128
Figure 2.74:	Grinding abatement flowsheet.....	130
Figure 2.75:	Grinding machine equipped with waste gas cleaning abatement system at Tata Steel IJmuiden	130
Figure 2.76:	Available heat versus exhaust gas temperature for different air preheat temperatures	142
Figure 2.77:	Schematic of a typical oxy-fuel burner operating with 100 % oxygen.....	143
Figure 2.78:	Schematic of a burner with external lancing for oxygen injection	143
Figure 2.79:	NO _x emissions versus fuel power for reheating furnace 301 (SSAB, Borlänge)	145
Figure 2.80:	NO _x emissions versus fuel power for reheating furnace 302 (SSAB, Borlänge)	145
Figure 2.81:	Monthly average NO _x emissions (expressed in mg/MJ) at SSAB Borlänge (Furnace 301) - prior to flameless combustion (black dots), after flameless combustion was installed in parts of the furnace (brown dots), and after complete installation of flameless combustion in the furnace (yellow dots).....	149
Figure 2.82:	Energy consumption (expressed in GJ/t) at SSAB Borlänge (Furnace 301) - prior to flameless combustion (blue dots), after flameless combustion was installed in parts of the furnace (red dots), and after complete installation of flameless combustion in the furnace (black dots)	149
Figure 2.83:	Schematic view of a walking beam furnace with De-NO _x	154
Figure 2.84:	NO _x emissions concentrations at Tata Steel IJmuiden pusher furnaces (No 21 and 22) with SCR and SNCR and at the walking beam furnaces (No 23 and 24) with SCR	154

Figure 2.85: Skid riders design in a reheating furnace before hot rolling.....	159
Figure 2.86: Double-pipes skid design for reheating furnaces	160
Figure 2.87: Top view of the skids distribution in a reheating furnace (the right part of the schematic is the furnace entry while the left part is the furnace exit)	160
Figure 2.88: Typical schematic of evaporative furnace skid cooling	162
Figure 2.89: Modified storage to increase charge temperature.....	165
Figure 2.90: Material flow - cold versus hot charging.....	166
Figure 2.91: Typical temperature evolution during thin slab casting followed by rolling.....	169
Figure 2.92: Schematic of the Compact Strip Production process (CSP).....	170
Figure 2.93: Schematic of the Inline Strip Production process (ISP)	170
Figure 2.94: Configurations of the Quality Strip Production (QSP) and Quality Strip Production Endless (QSP-E) concepts.....	171
Figure 2.95: Schematic view of the Endless Strip Production process (ESP)	171
Figure 2.96: Energy consumption for conventional hot strip mills (HSM) compared to ESP and CSP production processes.	172
Figure 2.97: Schematic of the components and picture of a sizing press	177
Figure 2.98: Automatic width control system operation.....	178
Figure 2.99: Coil box arrangement.....	180
Figure 2.100: Crop optimisation system.....	183
Figure 2.101: Schematic of a three-roll stand.....	195
Figure 2.102: Circular settling tank (vertical)	200
Figure 2.103: Horizontal flow settling tank.....	201
Figure 2.104: Schematic of a lamella separator.....	201
Figure 2.105: Screw-type clarifier	202
Figure 2.106: Example of a gravel filter showing in detail the backwash operation	203
Figure 2.107: Example of wire-netting filters showing in detail the backwash operation.....	203
Figure 2.108: Aerated fine scale-trap	204
Figure 2.109: Magnetic filtration (example high gradient MF).....	205
Figure 2.110: Example of a water recirculation system for a hot rolling mill	206
Figure 2.111: Treatment of backwashing water	207
Figure 2.112: Schematic of an Organic Rankine Cycle.....	210
Figure 2.113: Schematic showing the principles of the electrical welding of billets using water sprays in combination with a spark killer device for suppression of fugitive dust emissions.	212
Figure 3.1: Typical configurations of cold rolled strip mills	218
Figure 3.2: Coupled pickling and cold rolling process line with conventional batch processing vs continuous annealing and processing	219
Figure 3.3: Schematic of a continuous pickling line.....	220
Figure 3.4: 4-high stand in a cold rolling mill	222
Figure 3.5: 6-high stand in a cold rolling mill	223
Figure 3.6: Typical 20-roll mill for stainless steel rolling	225
Figure 3.7: Schematic of a hood-type annealing furnace.....	226
Figure 3.8: Example of temperatures during batch annealing cycle.....	227
Figure 3.9: Example of a continuous annealing furnace.....	228
Figure 3.10: Picture and detailed schematic of a cold pilger mill.....	231
Figure 3.11: General emulsion flow	233
Figure 3.12: Degreasing solution flow (continuous annealing line).....	234
Figure 3.13: Cooling water system for a cold mill	235
Figure 3.14: Cooling water system for HCl pickling and batch annealing	235
Figure 3.15: Cooling water system for a continuous annealing line.....	235
Figure 3.16: Input/output overview for cold rolling mills	239
Figure 3.17: Specific energy consumption (MJ/t of feedstock processed) for rolling	241
Figure 3.18: Specific energy consumption (MJ/t of feedstock processed) for continuous annealing after rolling.....	242
Figure 3.19: Specific energy consumption (MJ/t of feedstock processed) for batch annealing after rolling	243
Figure 3.20: Specific oil consumption (kg/t of feedstock processed) in cold rolling plants	245
Figure 3.21: Flow sheet for HCl pickling and acid regeneration.....	246
Figure 3.22: Flow sheet for H ₂ SO ₄ pickling and regeneration.....	247
Figure 3.23: Flow sheet for stainless steel pickling with HNO ₃ -HF acid (including recovery)	248
Figure 3.24: Specific HCl consumption (kg/m ² of treated surface) in cold rolling plants	249
Figure 3.25: Specific H ₂ SO ₄ consumption (kg/m ² of treated surface) in cold rolling plants.....	250
Figure 3.26: Specific HNO ₃ consumption (kg/m ² of treated surface) in cold rolling plants.....	251
Figure 3.27: Specific HF consumption (kg/m ² of treated surface) in cold rolling plants	252

Figure 3.28:	Specific water consumption (m ³ /t of feedstock processed) in cold rolling plants	253
Figure 3.29:	Example of parameters of a charge during the heating phase and the related emissions of NO _x (in ppm) including specific aspects to consider when measuring NO _x emissions from batch annealing furnaces, in particular the influence of air preheating on NO _x emissions.	255
Figure 3.30:	Test example of NO _x emissions (in ppm) and the influence of the power of the burner over the entire annealing cycle at C.D. Wälzholz cold rolling mill showing differences between the average emission concentration over the annealing cycle and the maximum emission concentration	256
Figure 3.31:	Dust emissions from mechanical processing and welding – Part 1 of 2	259
Figure 3.32:	Dust emissions from mechanical processing and welding – Part 2 of 2	260
Figure 3.33:	Lead emissions from descaling before pickling.....	261
Figure 3.34:	Nickel emissions from descaling before pickling	262
Figure 3.35:	Dust emissions from feedstock heating (in mg/Nm ³ at 3 % oxygen) using 100 % natural gas.....	263
Figure 3.36:	Dust emissions from feedstock heating (in mg/Nm ³ at 3 % oxygen) for fuels other than 100 % natural gas	264
Figure 3.37:	SO ₂ emissions from feedstock heating (in mg/Nm ³ at 3 % oxygen) using 100 % natural gas.....	265
Figure 3.38:	SO ₂ emissions from feedstock heating (in mg/Nm ³ at 3 % oxygen) for fuels other than 100 % natural gas	266
Figure 3.39:	NO _x emissions from feedstock heating (in mg/Nm ³ at 3 % oxygen) using 100 % natural gas.....	267
Figure 3.40:	NO _x emissions from feedstock heating (in mg/Nm ³ at 3 % oxygen) for fuels other than 100 % natural gas	268
Figure 3.41:	NO _x emissions from feedstock heating (in mg/Nm ³ at 3 % oxygen) using 100 % natural gas, without air preheating.....	269
Figure 3.42:	NO _x emissions from feedstock heating (in mg/Nm ³ at 3 % oxygen) for fuels other than 100 % natural gas, without air preheating	270
Figure 3.43:	NO _x emissions from feedstock heating (in mg/Nm ³ at 3 % oxygen) using 100 % natural gas, with air preheating temperature and feedstock inlet and target temperature	271
Figure 3.44:	NO _x emissions from feedstock heating (in mg/Nm ³ at 3 % oxygen) for fuels other than 100 % natural gas, with air preheating temperature and feedstock inlet and target temperature	272
Figure 3.45:	CO emissions from feedstock heating (in mg/Nm ³ at 3 % oxygen) using 100 % natural gas.....	273
Figure 3.46:	CO emissions from feedstock heating (in mg/Nm ³ at 3 % oxygen) for fuels other than 100 % natural gas	274
Figure 3.47:	Dust emissions from pickling (in mg/Nm ³) in hot rolling, cold rolling and hot dip coating plants.....	275
Figure 3.48:	HCl emissions from pickling (in mg/Nm ³) in hot rolling, cold rolling and hot dip coating plants.....	276
Figure 3.49:	SO _x emissions from pickling (in mg/Nm ³) in hot rolling and cold rolling plants	277
Figure 3.50:	NO _x emissions from pickling (in mg/Nm ³) in hot rolling and cold rolling plants.....	278
Figure 3.51:	HF emissions from pickling (in mg/Nm ³) in hot rolling and cold rolling plants	279
Figure 3.52:	TVOC emissions from rolling stands and finishing (in mg/Nm ³)	280
Figure 3.53:	Schematic of a laser welding machine (side view and upper view).....	284
Figure 3.54:	Dependence of rinse water utilisation on iron content.....	289
Figure 3.55:	Example of effluent-free HCl pickling and acid regeneration	290
Figure 3.56:	Spent emulsion splitting system	311
Figure 3.57:	Classical degreasing process.....	315
Figure 3.58:	Overview of the continuous annealing line at SSAB Borlänge cold rolling mill (Sweden).....	319
Figure 3.59:	Schematic of the treatment using SCR of waste gases from the continuous annealing line at SSAB Borlänge cold rolling mill (Sweden).....	319
Figure 3.60:	NO _x emission concentrations at SSAB Borlänge cold rolling mill (Sweden) before and after the SCR abatement system.....	320
Figure 3.61:	Abatement efficiency of the SCR system (%), ammonia consumption expressed in kg/h and exhaust gas flow rates expressed in kNm ³ /h at at SSAB Borlänge cold rolling mill (Sweden).....	320
Figure 3.62:	Dust abatement for shot blast texturing operations.....	331
Figure 4.1:	Production of low-carbon galvanised wire	336
Figure 4.2:	Production of high-carbon galvanised wire	337

Figure 4.3:	Input/output balance for a wire drawing mill	343
Figure 4.4:	Specific energy consumption (MJ/t of feedstock processed) for wire drawing.....	349
Figure 4.5:	Specific water consumption (m ³ /t of production) in wire drawing plants	350
Figure 4.6:	Dust emissions from wire drawing (wet and dry drawing)	351
Figure 4.7:	Dust emissions from feedstock heating.....	352
Figure 4.8:	SO ₂ emissions from feedstock heating	353
Figure 4.9:	NO _x and CO emissions from feedstock heating	354
Figure 4.10:	HCl emissions from pickling of wire rod (in mg/Nm ³) in wire drawing plants	355
Figure 5.1:	General structure of a hot dip coating line dedicated to the processing of hot rolled coils coupled to a pickling section.....	377
Figure 5.2:	Degreasing line layouts	378
Figure 5.3:	General structure of a hot dip coating line equipped with a direct flame furnace for processing hot rolled coils and cold rolled coils	380
Figure 5.4:	General structure of a hot dip coating line equipped with a degreasing section and a radiant tube furnace for processing typically cold rolled coils.....	380
Figure 5.5:	Detail of a three-roll system used in continuous hot dipping baths.....	381
Figure 5.6:	Schematic coating section of a galvannealing line.....	382
Figure 5.7:	Typical configuration of a cooling loop with cooling towers.....	386
Figure 5.8:	Cooling water system with heat exchangers	387
Figure 5.9:	Aluminium coating process.....	388
Figure 5.10:	Input/output balance for continuous hot dip (sheet) coating lines.....	391
Figure 5.11:	Specific energy consumption (MJ/t of feedstock processed) for feedstock heating before hot dipping of sheets and wire.....	393
Figure 5.12:	Specific oil consumption (kg/t of production) in hot dip coating plants of sheet and wire	395
Figure 5.13:	Specific fresh water consumption (m ³ /t of production) in hot dip coating plants of sheet and wire.....	396
Figure 5.14:	Correlation between air preheating temperature, burner power and NO _x emissions measured at a radiant tube pilot plant operated by ArcelorMittal (Asturias, Spain)	398
Figure 5.15:	Dust emissions from feedstock heating of sheet (in mg/Nm ³ at 3 % oxygen)	400
Figure 5.16:	SO ₂ emissions from feedstock heating of sheet (in mg/Nm ³ at 3 % oxygen).....	401
Figure 5.17:	NO _x and CO emissions from feedstock heating of sheet and wire (in mg/Nm ³ at 3 % oxygen).....	402
Figure 5.18:	NO _x and CO emissions from feedstock heating of sheet and wire without air preheating (in mg/Nm ³ at 3 % oxygen).....	403
Figure 5.19:	NO _x and CO emissions from feedstock heating of sheet and wire with air preheating temperature, feedstock inlet and target temperatures (in mg/Nm ³ at 3 % oxygen)	404
Figure 5.20:	CO emissions from feedstock heating of sheet and wire (in mg/Nm ³ at 3 % oxygen).....	405
Figure 5.21:	TVOC emissions from degreasing of sheet.....	406
Figure 5.22:	Example of a degreasing solution recycling system.....	409
Figure 5.23:	Schematic of a direct-flame furnace.....	411
Figure 5.24:	Chemical pretreatment section for a sheet hot dip coating line (example).....	412
Figure 5.25:	Schematic of a hot dip galvanising line coating section with air knife actuators and a coating mass sensor.....	414
Figure 5.26:	Schematic of an electromagnetic stabiliser	416
Figure 5.27:	Schematic of a galvannealing treatment tower equipped with induction heating	417
Figure 5.28:	Schematic of the galvannealing induction furnace.....	418
Figure 5.29:	Roll coater.....	425
Figure 5.30:	Schematic diagram of a jet vapour deposition unit for coating a moving strip of steel with zinc	434
Figure 6.1:	Typical process flow for a general galvanising plant.....	439
Figure 6.2:	Principle of tube galvanising.....	440
Figure 6.3:	Material flow sheet for general galvanising plants.....	447
Figure 6.4:	Specific energy consumption (kWh/t of feedstock processed) in batch galvanising.....	456
Figure 6.5:	Specific energy consumption (kWh/t of feedstock processed) in batch galvanising including the yearly production throughput (production/hot dipping bath volume)	457
Figure 6.6:	Specific energy consumption (kWh/t of feedstock processed) for heating of the batch galvanising kettle	458
Figure 6.7:	Specific consumption (kg/t of steel coated) of acidic degreasing solutions in batch galvanising plants.....	459
Figure 6.8:	Specific consumption (kg/t of steel coated) of alkaline degreasing solutions in batch galvanising plants.....	460
Figure 6.9:	Specific HCl consumption (kg/t of steel coated) in pickling in batch galvanising plants ..	461

Figure 6.10:	Specific pickling inhibitors consumption (kg/t of steel coated) in pickling in batch galvanising plants	462
Figure 6.11:	Specific flux agent consumption (kg/t of steel coated) in pickling in batch galvanising plants.....	463
Figure 6.12:	NO _x and CO emissions from heating the galvanising kettle (in mg/Nm ³ at 3 % oxygen)	464
Figure 6.13:	NO _x and CO emissions from feedstock drying (in mg/Nm ³ at 3 % oxygen)	465
Figure 6.14:	HCl emissions from pickling (in mg/Nm ³) in batch galvanising plants.....	466
Figure 6.15:	Dust emissions from hot dipping (in mg/Nm ³) in batch galvanising plants	467
Figure 6.16:	Dust emissions from hot dipping (in mg/Nm ³) in batch galvanising plants using low-fume flux	468
Figure 6.17:	Specific generation of spent alkaline degreasing solution (in kg/t)	469
Figure 6.18:	Specific generation of spent acidic degreasing solution (in kg/t)	470
Figure 6.19:	Specific generation of oily sludge from degreasing solution (in kg/t).....	471
Figure 6.20:	Specific generation of spent HCl from pickling and stripping (in kg/t).....	472
Figure 6.21:	Specific generation of spent flux (in kg/t)	473
Figure 6.22:	Specific generation of bottom dross (in kg/t)	474
Figure 6.23:	Specific generation of zinc ash (in kg/t)	475
Figure 6.24:	Flowsheet for biological degreasing	478
Figure 6.25:	Example flowsheet for evaporative HCl recovery	480
Figure 6.26:	Example mass balance for evaporative HCl recovery	480
Figure 6.27:	Flow chart for removal of zinc from pickling baths	482
Figure 6.28:	Schematic of the solvent extraction process	484
Figure 6.29:	Limiting curve for the operation of open HCl pickling baths.....	487
Figure 6.30:	Extraction systems (lip and lateral hoods) used in open pickling tank operations.....	489
Figure 6.31:	Schematic for an enclosed pretreatment section in batch galvanising	490
Figure 7.1:	Dust emissions from acid recovery (in mg/Nm ³).....	501
Figure 7.2:	HCl emissions from acid recovery (in mg/Nm ³)	502
Figure 7.3:	SO ₂ emissions from acid recovery (in mg/Nm ³).....	503
Figure 7.4:	NO _x emissions from acid recovery (in mg/Nm ³)	504
Figure 7.5:	HF emissions from acid recovery (in mg/Nm ³).....	505
Figure 7.6:	Cadmium emissions (in µg/l) for direct discharges	510
Figure 7.7:	Cadmium emissions (in µg/l) for indirect discharges	511
Figure 7.8:	COD emissions (in mg/l) for direct discharges.....	512
Figure 7.9:	COD emissions (in mg/l) for indirect discharges.....	513
Figure 7.10:	Chromium emissions (in mg/l) for direct discharges.....	514
Figure 7.11:	Chromium emissions (in mg/l) for direct discharges (sorted by steel category)	515
Figure 7.12:	Chromium emissions (in mg/l) for indirect discharges.....	516
Figure 7.13:	Chromium emissions (in mg/l) for indirect discharges (sorted by steel category)	517
Figure 7.14:	Chromium VI emissions (in µg/l) for direct discharges.....	518
Figure 7.15:	Chromium VI emissions (in µg/l) for indirect discharges.....	519
Figure 7.16:	Fluoride emissions (in mg/l) for direct discharges.....	520
Figure 7.17:	Fluoride emissions (in mg/l) for indirect discharges	521
Figure 7.18:	Iron emissions (in mg/l) for direct discharges	522
Figure 7.19:	Iron emissions (in mg/l) for indirect discharges	523
Figure 7.20:	Mercury emissions (in µg/l) for direct discharges	524
Figure 7.21:	Mercury emissions (in µg/l) for indirect discharges	525
Figure 7.22:	Hydrocarbon oil index emissions (in mg/l) for direct discharges	526
Figure 7.23:	Hydrocarbon oil index emissions (in mg/l) for indirect discharges	527
Figure 7.24:	Nickel emissions (in mg/l) for direct discharges	528
Figure 7.25:	Nickel emissions (in mg/l) for direct discharges (sorted by steel category)	529
Figure 7.26:	Nickel emissions (in mg/l) for indirect discharges	530
Figure 7.27:	Nickel emissions (in mg/l) for indirect discharges (sorted by steel category)	531
Figure 7.28:	Oil emissions (in mg/l) for direct discharges	532
Figure 7.29:	Oil emissions (in mg/l) for indirect discharges.....	533
Figure 7.30:	Phosphorus emissions (in mg/l) for direct discharges	534
Figure 7.31:	Phosphorus emissions (in mg/l) for indirect discharges	535
Figure 7.32:	Lead emissions (in µg/l) for direct discharges	536
Figure 7.33:	Lead emissions (in µg/l) for indirect discharges.....	537
Figure 7.34:	Tin emissions (in mg/l) for direct discharges	538
Figure 7.35:	Tin emissions (in mg/l) for indirect discharges	539
Figure 7.36:	Suspended solid emissions (in mg/l) for direct discharges	540
Figure 7.37:	Suspended solid emissions (in mg/l) for indirect discharges	541
Figure 7.38:	TOC emissions (in mg/l) for direct discharges	542

Figure 7.39: TOC emissions (in mg/l) for indirect discharges	543
Figure 7.40: Total suspended solid emissions (in mg/l) for direct discharges	544
Figure 7.41: Total suspended solid emissions (in mg/l) for indirect discharges	545
Figure 7.42: Zinc emissions (in mg/l) for direct discharges	546
Figure 7.43: Zinc emissions (in mg/l) for indirect discharges	547
Figure 8.1: Continuous improvement in an EMS model	550
Figure 8.2: Coil support lined with rubber corresponding to the coil geometry	561
Figure 8.3: Coil support with oil drip trays	561
Figure 8.4: Coil tong with protector	562
Figure 8.5: C-hook magnet for hoisting of coils	562
Figure 8.6: Piler with mandrels for coil manipulation and transport	563
Figure 8.7: Chemical reactions within 100 % Hydrogen Bell Annealing	576
Figure 8.8: Principle of slab preheating using waste gas	580
Figure 8.9: Potential fuel savings with preheating of combustion air	583
Figure 8.10: Schematic of a regenerative burner system	584
Figure 8.11: Schematic of a self-recuperative burner	585
Figure 8.12: Typical exhaust gas recuperators	586
Figure 8.13: Typical compact recuperato	586
Figure 8.14: Schematic of a regenerative burner system in radiant tubes	587
Figure 8.15: Typical recuperative burner in radiant tubes	588
Figure 8.16: Basic schematic of a waste heat recovery boiler	589
Figure 8.17: Example flowsheet for ceramic filtration of degreasing solution	593
Figure 8.18: Principle of heat exchangers	596
Figure 8.19: Principle of submerged combustion	596
Figure 8.20: Different types of pickling tanks	604
Figure 8.21: Flowsheet for activated pickling	607
Figure 8.22: Reverse cascade rinsing at a batch galvanising plant	609
Figure 8.23: Flow sheet for flux regeneration	611
Figure 8.24: Schematic of the electrolytic oxidation process	612
Figure 8.25: Vacuum cooling crystallisation process for H ₂ SO ₄	620
Figure 8.26: Evaporative acid recovery	621
Figure 8.27: Principle of diffusion dialysis	622
Figure 8.28: Fluidised bed HCl acid regeneration process	623
Figure 8.29: Spray roasting HCl acid regeneration process	624
Figure 8.30: Process flowsheet for the production of high-purity oxides	625
Figure 8.31: Spray roasting mixed acid regeneration process	626
Figure 8.32: Principle of salt splitting by bipolar membranes	628
Figure 8.33: Evaporation process for mixed acid regeneration	629
Figure 8.34: Rinsing systems	638
Figure 8.35: Schematic of a low-NO _x burner with internal flue-gas recirculation	653
Figure 8.36: Schematic example of an air-staged low-NO _x burner	654
Figure 8.37: Schematic of a burner equipped with FGR	657
Figure 8.38: Effect of flue-gas recirculation on NO _x emission	657
Figure 8.39: Example of the relation of NO _x and air preheating temperature for a natural-gas-fired walking beam furnace	660
Figure 8.40: Example of the relation of NO _x and air preheating temperature for a (mainly) COG-fired reheating furnace	660
Figure 8.41: Example of the relation of NO _x and air preheating temperature for a COG-fired reheating furnace	661
Figure 8.42: Design principles for closed pickling tanks	666
Figure 8.43: Principle of packed scrubbers	668
Figure 8.44: Principle of a cross-flow scrubber	669
Figure 8.45: Principle of plate scrubbers	670
Figure 8.46: Principle of fume filter	671
Figure 8.47: Schematic for injecting H ₂ O ₂ into pickling acid recirculation loop	678
Figure 8.48: Schematic for injecting H ₂ O ₂ into pickling baths via a sparge pipe	678
Figure 8.49: Bilateral peripheral exhaust with auxiliaries	687
Figure 8.50: Lip extraction at a batch galvanising plant	687
Figure 8.51: Stationary enclosure	689
Figure 8.52: Moveable enclosure with vertical moving side walls	690
Figure 8.53: Principle of ultrafiltration	702
Figure 8.54: Spent degreasing solution flow (example of a continuous annealing line)	703
Figure 8.55: Schematic of a rotary kiln plant for thermal treatment of oily mill scale	709

Figure 8.56: Picture of a rotary kiln for thermal treatment of oily mill scale at an ArcelorMittal integrated plant	709
Figure 8.57: Thermal treatment (i.e. calcining and sintering) of hydroxide sludge obtained after neutralisation of spent acids.....	714
Figure 11.1: Schematic of a generic waste water system.....	799
Figure 11.2: Schematic of different line layouts in a common waste water treatment plant.....	799

List of tables

Figure 1.1:	Hot and cold formed products covered by this BREF.....	36
Figure 2.1:	Overview of hot rolled products.....	46
Figure 2.2:	Typical designs for hot strip mills.....	48
Figure 2.3:	Hot strip production with two thin slab casters, two reheating furnaces and one finishing mill; capacity 2 Mt/yr.....	49
Figure 2.4:	Hot strip production with two thin slab casters, two reheating furnaces, one continuous roughing mill, bar heater and finishing mill; capacity 3 Mt/yr.....	49
Figure 2.5:	Hot strip production with one thin slab caster directly coupled with one continuous roughing mill, inductive bar heater and endless or semi-endless finishing mill; capacity 2 Mt/yr	50
Figure 2.6:	Typical Steckel mill configuration	50
Figure 2.7:	Steckel mill with coiling furnaces	51
Figure 2.8:	Typical plate mill configuration with one 4-high horizontal rolling stand.....	51
Figure 2.9:	Typical layout of a wire rod mill.....	52
Figure 2.10:	Profiled rolls for sheet piling sections.....	54
Figure 2.11:	Universal stands for parallel flanged product.....	54
Figure 2.12:	Plant layout of a heavy section mill	55
Figure 2.13:	Plant layout of a heavy/medium section mill for sheet piling	55
Figure 2.14:	Examples of beam blanks' cross sections	56
Figure 2.15:	Medium section mill fed by cast beam blanks	56
Figure 2.16:	Mandrel mill.....	57
Figure 2.17:	Plug mill.....	58
Figure 2.18:	Pit furnace	60
Figure 2.19:	Pusher-type furnace.....	60
Figure 2.20:	Walking beam furnace	61
Figure 2.21:	Typical design of a rotary hearth furnace.....	61
Figure 2.22:	Roller arrangement of wire rod finishing section.....	63
Figure 2.23:	Material cut into blanks after heating in an induction furnace and blanks heated in a batch furnace after cutting cold.....	64
Figure 2.24:	Blanks pierced, pressed and rolled in a radial rolling mill and in an axial rolling mill.....	64
Figure 2.25:	Different types of water cooling.....	65
Figure 2.26:	Example of a once-through water system	66
Figure 2.27:	Example of a semi-closed water circuit	67
Figure 2.28:	Example of a closed water circuit	68
Figure 2.29:	Water loops for hot strip rolling mill.....	68
Figure 2.30:	Use of water loops in a hot rolling mill.....	69
Figure 2.31:	Input/output overview for hot rolling mills	71
Figure 2.32:	Specific energy consumption (MJ/t of feedstock processed) for feedstock reheating.....	75
Figure 2.33:	Specific energy consumption (MJ/t of feedstock processed) for feedstock intermediate heating.....	76
Figure 2.34:	Specific energy consumption (MJ/t of feedstock processed) for feedstock post-heating.....	77
Figure 2.35:	Specific energy consumption (MJ/t of feedstock processed) for rolling processes.....	78
Figure 2.36:	Specific oil consumption (kg/t of production) in hot rolling plants	80
Figure 2.37:	Specific HCl consumption (kg/m ² of treated surface) in HRPO plants.....	82
Figure 2.38:	Specific H ₂ SO ₄ consumption (kg/m ² of treated surface) in HRPO plants.....	83
Figure 2.39:	Specific HF/HNO ₃ consumption (kg/m ² of treated surface) in HRPO plants	84
Figure 2.40:	Specific water consumption (m ³ /t of production) in hot rolling plants	86
Figure 2.41:	NO _x emissions and air preheating temperature for a post-heating treatment furnace at SSAB Oxelösund, Sweden.....	89
Figure 2.42:	NO _x emissions and air preheating temperature	90
Figure 2.43:	Effect of fuel type on flame temperature.....	91
Figure 2.44:	NO _x emission concentrations as a function of the type of fuels used in the reheating furnace (COG and HFO).....	91
Figure 2.45:	Continuously measured NO _x emission concentrations for pusher-type furnaces at Tata Steel IJmuiden (Plant 110 HR2-1) showing NO _x fluctuations over a year.....	92
Figure 2.46:	Continuously measured NO _x emission concentrations at two walking beam furnaces from Tata Steel IJmuiden (Plant 110 HR2-2) showing NO _x fluctuation over a year.....	93
Figure 2.47:	Dust emissions from mechanical processing, scarfing and welding (in mg/Nm ³) - Part 1 of 2	98
Figure 2.48:	Dust emissions from mechanical processing, scarfing and welding (in mg/Nm ³) - Part 2 of 2	99

Figure 2.49:	Lead emissions from mechanical processing, scarfing and welding (in mg/Nm ³)	100
Figure 2.50:	Nickel emissions from mechanical processing, scarfing and welding (in mg/Nm ³).....	101
Figure 2.51:	Dust emissions from feedstock heating (in mg/Nm ³ at 3 % oxygen) for 100% natural gas.....	102
Figure 2.52:	Dust emissions from feedstock heating (in mg/Nm ³ at 3 % oxygen) for fuels other than 100 % natural gas	103
Figure 2.53:	SO ₂ emissions from feedstock heating (in mg/Nm ³ at 3 % oxygen) for 100 % natural gas.....	104
Figure 2.54:	SO ₂ emissions from feedstock heating (in mg/Nm ³ at 3 % oxygen) for fuels other than 100 % natural gas	105
Figure 2.55:	NO _x emissions from reheating (in mg/Nm ³ at 3 % oxygen) for 100 % natural gas – Part 1 of 2.....	106
Figure 2.56:	NO _x emissions from reheating (in mg/Nm ³ at 3 % oxygen) for 100 % natural gas – Part 2 of 2.....	107
Figure 2.57:	NO _x emissions from intermediate and post-heating (in mg/Nm ³ at 3 % oxygen) for 100 % natural gas	108
Figure 2.58:	NO _x emissions from reheating intermediate and post-heating (in mg/Nm ³ at 3 % oxygen) for fuels other than 100 % natural gas	109
Figure 2.59:	NO _x emissions from reheating (in mg/Nm ³ at 3 % oxygen) for 100 % natural gas for reheating of flat products.....	110
Figure 2.60:	NO _x emissions from reheating (in mg/Nm ³ at 3 % oxygen) for fuels other than 100 % natural gas for reheating of flat products	111
Figure 2.61:	NO _x emissions from reheating, intermediate and post-heating (in mg/Nm ³ at 3 % oxygen) for 100 % natural gas, without air preheating	112
Figure 2.62:	NO _x emissions from reheating, intermediate and post-heating (in mg/Nm ³ at 3 % oxygen) for fuels other than 100 % natural gas, without air preheating	113
Figure 2.63:	NO _x emissions from reheating (in mg/Nm ³ at 3 % oxygen) for 100 % natural gas, with air preheating temperature and feedstock target temperature – Part 1 of 2.....	114
Figure 2.64:	NO _x emissions from reheating (in mg/Nm ³ at 3 % oxygen) for 100 % natural gas, with air preheating temperature and feedstock target temperature – Part 2 of 2.....	115
Figure 2.65:	NO _x emissions from intermediate and post-heating (in mg/Nm ³ at 3 % oxygen) for 100 % natural gas, with air preheating temperature and feedstock target temperature.....	116
Figure 2.66:	NO _x emissions from reheating and post-heating (in mg/Nm ³ at 3 % oxygen) for fuels other than 100 % natural gas, with air preheating temperature and feedstock target temperature	117
Figure 2.67:	CO emissions from reheating (in mg/Nm ³ at 3 % oxygen) for 100 % natural gas	118
Figure 2.68:	CO emissions from intermediate and post-heating (in mg/Nm ³ at 3 % oxygen) for 100 % natural gas	119
Figure 2.69:	CO emissions from reheating and post-heating (in mg/Nm ³ at 3 % oxygen) for fuels other than 100 % natural gas.....	120
Figure 2.70:	Specific generation of oil-containing residues (in kg/t).....	122
Figure 2.71:	Specific generation of scale (in kg/t)	123
Figure 2.72:	Specific generation of filter dust (in kg/t).....	124
Figure 2.73:	Scarfing abatement flowsheet (example with wet EP)	128
Figure 2.74:	Grinding abatement flowsheet.....	130
Figure 2.75:	Grinding machine equipped with waste gas cleaning abatement system at Tata Steel IJmuiden	130
Figure 2.76:	Available heat versus exhaust gas temperature for different air preheat temperatures	142
Figure 2.77:	Schematic of a typical oxy-fuel burner operating with 100 % oxygen.....	143
Figure 2.78:	Schematic of a burner with external lancing for oxygen injection	143
Figure 2.79:	NO _x emissions versus fuel power for reheating furnace 301 (SSAB, Borlänge)	145
Figure 2.80:	NO _x emissions versus fuel power for reheating furnace 302 (SSAB, Borlänge)	145
Figure 2.81:	Monthly average NO _x emissions (expressed in mg/MJ) at SSAB Borlänge (Furnace 301) - prior to flameless combustion (black dots), after flameless combustion was installed in parts of the furnace (brown dots), and after complete installation of flameless combustion in the furnace (yellow dots).....	149
Figure 2.82:	Energy consumption (expressed in GJ/t) at SSAB Borlänge (Furnace 301) - prior to flameless combustion (blue dots), after flameless combustion was installed in parts of the furnace (red dots), and after complete installation of flameless combustion in the furnace (black dots)	149
Figure 2.83:	Schematic view of a walking beam furnace with De-NO _x	154
Figure 2.84:	NO _x emissions concentrations at Tata Steel IJmuiden pusher furnaces (No 21 and 22) with SCR and SNCR and at the walking beam furnaces (No 23 and 24) with SCR	154

Figure 2.85: Skid riders design in a reheating furnace before hot rolling.....	159
Figure 2.86: Double-pipes skid design for reheating furnaces	160
Figure 2.87: Top view of the skids distribution in a reheating furnace (the right part of the schematic is the furnace entry while the left part is the furnace exit)	160
Figure 2.88: Typical schematic of evaporative furnace skid cooling	162
Figure 2.89: Modified storage to increase charge temperature.....	165
Figure 2.90: Material flow - cold versus hot charging.....	166
Figure 2.91: Typical temperature evolution during thin slab casting followed by rolling.....	169
Figure 2.92: Schematic of the Compact Strip Production process (CSP).....	170
Figure 2.93: Schematic of the Inline Strip Production process (ISP)	170
Figure 2.94: Configurations of the Quality Strip Production (QSP) and Quality Strip Production Endless (QSP-E) concepts.....	171
Figure 2.95: Schematic view of the Endless Strip Production process (ESP)	171
Figure 2.96: Energy consumption for conventional hot strip mills (HSM) compared to ESP and CSP production processes.	172
Figure 2.97: Schematic of the components and picture of a sizing press	177
Figure 2.98: Automatic width control system operation.....	178
Figure 2.99: Coil box arrangement.....	180
Figure 2.100: Crop optimisation system.....	183
Figure 2.101: Schematic of a three-roll stand.....	195
Figure 2.102: Circular settling tank (vertical)	200
Figure 2.103: Horizontal flow settling tank.....	201
Figure 2.104: Schematic of a lamella separator.....	201
Figure 2.105: Screw-type clarifier	202
Figure 2.106: Example of a gravel filter showing in detail the backwash operation	203
Figure 2.107: Example of wire-netting filters showing in detail the backwash operation.....	203
Figure 2.108: Aerated fine scale-trap	204
Figure 2.109: Magnetic filtration (example high gradient MF).....	205
Figure 2.110: Example of a water recirculation system for a hot rolling mill	206
Figure 2.111: Treatment of backwashing water	207
Figure 2.112: Schematic of an Organic Rankine Cycle.....	210
Figure 2.113: Schematic showing the principles of the electrical welding of billets using water sprays in combination with a spark killer device for suppression of fugitive dust emissions.	212
Figure 3.1: Typical configurations of cold rolled strip mills	218
Figure 3.2: Coupled pickling and cold rolling process line with conventional batch processing vs continuous annealing and processing	219
Figure 3.3: Schematic of a continuous pickling line.....	220
Figure 3.4: 4-high stand in a cold rolling mill	222
Figure 3.5: 6-high stand in a cold rolling mill	223
Figure 3.6: Typical 20-roll mill for stainless steel rolling	225
Figure 3.7: Schematic of a hood-type annealing furnace.....	226
Figure 3.8: Example of temperatures during batch annealing cycle.....	227
Figure 3.9: Example of a continuous annealing furnace.....	228
Figure 3.10: Picture and detailed schematic of a cold pilger mill.....	231
Figure 3.11: General emulsion flow	233
Figure 3.12: Degreasing solution flow (continuous annealing line).....	234
Figure 3.13: Cooling water system for a cold mill	235
Figure 3.14: Cooling water system for HCl pickling and batch annealing	235
Figure 3.15: Cooling water system for a continuous annealing line.....	235
Figure 3.16: Input/output overview for cold rolling mills	239
Figure 3.17: Specific energy consumption (MJ/t of feedstock processed) for rolling	241
Figure 3.18: Specific energy consumption (MJ/t of feedstock processed) for continuous annealing after rolling.....	242
Figure 3.19: Specific energy consumption (MJ/t of feedstock processed) for batch annealing after rolling	243
Figure 3.20: Specific oil consumption (kg/t of feedstock processed) in cold rolling plants	245
Figure 3.21: Flow sheet for HCl pickling and acid regeneration.....	246
Figure 3.22: Flow sheet for H ₂ SO ₄ pickling and regeneration.....	247
Figure 3.23: Flow sheet for stainless steel pickling with HNO ₃ -HF acid (including recovery)	248
Figure 3.24: Specific HCl consumption (kg/m ² of treated surface) in cold rolling plants	249
Figure 3.25: Specific H ₂ SO ₄ consumption (kg/m ² of treated surface) in cold rolling plants.....	250
Figure 3.26: Specific HNO ₃ consumption (kg/m ² of treated surface) in cold rolling plants.....	251
Figure 3.27: Specific HF consumption (kg/m ² of treated surface) in cold rolling plants	252

Figure 3.28:	Specific water consumption (m ³ /t of feedstock processed) in cold rolling plants	253
Figure 3.29:	Example of parameters of a charge during the heating phase and the related emissions of NO _x (in ppm) including specific aspects to consider when measuring NO _x emissions from batch annealing furnaces, in particular the influence of air preheating on NO _x emissions.	255
Figure 3.30:	Test example of NO _x emissions (in ppm) and the influence of the power of the burner over the entire annealing cycle at C.D. Wälzholz cold rolling mill showing differences between the average emission concentration over the annealing cycle and the maximum emission concentration	256
Figure 3.31:	Dust emissions from mechanical processing and welding – Part 1 of 2	259
Figure 3.32:	Dust emissions from mechanical processing and welding – Part 2 of 2	260
Figure 3.33:	Lead emissions from descaling before pickling.....	261
Figure 3.34:	Nickel emissions from descaling before pickling	262
Figure 3.35:	Dust emissions from feedstock heating (in mg/Nm ³ at 3 % oxygen) using 100 % natural gas.....	263
Figure 3.36:	Dust emissions from feedstock heating (in mg/Nm ³ at 3 % oxygen) for fuels other than 100 % natural gas	264
Figure 3.37:	SO ₂ emissions from feedstock heating (in mg/Nm ³ at 3 % oxygen) using 100 % natural gas.....	265
Figure 3.38:	SO ₂ emissions from feedstock heating (in mg/Nm ³ at 3 % oxygen) for fuels other than 100 % natural gas	266
Figure 3.39:	NO _x emissions from feedstock heating (in mg/Nm ³ at 3 % oxygen) using 100 % natural gas.....	267
Figure 3.40:	NO _x emissions from feedstock heating (in mg/Nm ³ at 3 % oxygen) for fuels other than 100 % natural gas	268
Figure 3.41:	NO _x emissions from feedstock heating (in mg/Nm ³ at 3 % oxygen) using 100 % natural gas, without air preheating.....	269
Figure 3.42:	NO _x emissions from feedstock heating (in mg/Nm ³ at 3 % oxygen) for fuels other than 100 % natural gas, without air preheating	270
Figure 3.43:	NO _x emissions from feedstock heating (in mg/Nm ³ at 3 % oxygen) using 100 % natural gas, with air preheating temperature and feedstock inlet and target temperature	271
Figure 3.44:	NO _x emissions from feedstock heating (in mg/Nm ³ at 3 % oxygen) for fuels other than 100 % natural gas, with air preheating temperature and feedstock inlet and target temperature	272
Figure 3.45:	CO emissions from feedstock heating (in mg/Nm ³ at 3 % oxygen) using 100 % natural gas.....	273
Figure 3.46:	CO emissions from feedstock heating (in mg/Nm ³ at 3 % oxygen) for fuels other than 100 % natural gas	274
Figure 3.47:	Dust emissions from pickling (in mg/Nm ³) in hot rolling, cold rolling and hot dip coating plants.....	275
Figure 3.48:	HCl emissions from pickling (in mg/Nm ³) in hot rolling, cold rolling and hot dip coating plants.....	276
Figure 3.49:	SO _x emissions from pickling (in mg/Nm ³) in hot rolling and cold rolling plants	277
Figure 3.50:	NO _x emissions from pickling (in mg/Nm ³) in hot rolling and cold rolling plants.....	278
Figure 3.51:	HF emissions from pickling (in mg/Nm ³) in hot rolling and cold rolling plants	279
Figure 3.52:	TVOC emissions from rolling stands and finishing (in mg/Nm ³)	280
Figure 3.53:	Schematic of a laser welding machine (side view and upper view).....	284
Figure 3.54:	Dependence of rinse water utilisation on iron content.....	289
Figure 3.55:	Example of effluent-free HCl pickling and acid regeneration	290
Figure 3.56:	Spent emulsion splitting system	311
Figure 3.57:	Classical degreasing process.....	315
Figure 3.58:	Overview of the continuous annealing line at SSAB Borlänge cold rolling mill (Sweden).....	319
Figure 3.59:	Schematic of the treatment using SCR of waste gases from the continuous annealing line at SSAB Borlänge cold rolling mill (Sweden).....	319
Figure 3.60:	NO _x emission concentrations at SSAB Borlänge cold rolling mill (Sweden) before and after the SCR abatement system.....	320
Figure 3.61:	Abatement efficiency of the SCR system (%), ammonia consumption expressed in kg/h and exhaust gas flow rates expressed in kNm ³ /h at at SSAB Borlänge cold rolling mill (Sweden).....	320
Figure 3.62:	Dust abatement for shot blast texturing operations.....	331
Figure 4.1:	Production of low-carbon galvanised wire	336
Figure 4.2:	Production of high-carbon galvanised wire	337

Figure 4.3:	Input/output balance for a wire drawing mill	343
Figure 4.4:	Specific energy consumption (MJ/t of feedstock processed) for wire drawing.....	349
Figure 4.5:	Specific water consumption (m ³ /t of production) in wire drawing plants	350
Figure 4.6:	Dust emissions from wire drawing (wet and dry drawing)	351
Figure 4.7:	Dust emissions from feedstock heating.....	352
Figure 4.8:	SO ₂ emissions from feedstock heating	353
Figure 4.9:	NO _x and CO emissions from feedstock heating	354
Figure 4.10:	HCl emissions from pickling of wire rod (in mg/Nm ³) in wire drawing plants	355
Figure 5.1:	General structure of a hot dip coating line dedicated to the processing of hot rolled coils coupled to a pickling section.....	377
Figure 5.2:	Degreasing line layouts	378
Figure 5.3:	General structure of a hot dip coating line equipped with a direct flame furnace for processing hot rolled coils and cold rolled coils	380
Figure 5.4:	General structure of a hot dip coating line equipped with a degreasing section and a radiant tube furnace for processing typically cold rolled coils.....	380
Figure 5.5:	Detail of a three-roll system used in continuous hot dipping baths.....	381
Figure 5.6:	Schematic coating section of a galvannealing line.....	382
Figure 5.7:	Typical configuration of a cooling loop with cooling towers.....	386
Figure 5.8:	Cooling water system with heat exchangers	387
Figure 5.9:	Aluminium coating process.....	388
Figure 5.10:	Input/output balance for continuous hot dip (sheet) coating lines.....	391
Figure 5.11:	Specific energy consumption (MJ/t of feedstock processed) for feedstock heating before hot dipping of sheets and wire.....	393
Figure 5.12:	Specific oil consumption (kg/t of production) in hot dip coating plants of sheet and wire.....	395
Figure 5.13:	Specific fresh water consumption (m ³ /t of production) in hot dip coating plants of sheet and wire.....	396
Figure 5.14:	Correlation between air preheating temperature, burner power and NO _x emissions measured at a radiant tube pilot plant operated by ArcelorMittal (Asturias, Spain)	398
Figure 5.15:	Dust emissions from feedstock heating of sheet (in mg/Nm ³ at 3 % oxygen)	400
Figure 5.16:	SO ₂ emissions from feedstock heating of sheet (in mg/Nm ³ at 3 % oxygen).....	401
Figure 5.17:	NO _x and CO emissions from feedstock heating of sheet and wire (in mg/Nm ³ at 3 % oxygen).....	402
Figure 5.18:	NO _x and CO emissions from feedstock heating of sheet and wire without air preheating (in mg/Nm ³ at 3 % oxygen).....	403
Figure 5.19:	NO _x and CO emissions from feedstock heating of sheet and wire with air preheating temperature, feedstock inlet and target temperatures (in mg/Nm ³ at 3 % oxygen)	404
Figure 5.20:	CO emissions from feedstock heating of sheet and wire (in mg/Nm ³ at 3 % oxygen).....	405
Figure 5.21:	TVOC emissions from degreasing of sheet.....	406
Figure 5.22:	Example of a degreasing solution recycling system.....	409
Figure 5.23:	Schematic of a direct-flame furnace.....	411
Figure 5.24:	Chemical pretreatment section for a sheet hot dip coating line (example).....	412
Figure 5.25:	Schematic of a hot dip galvanising line coating section with air knife actuators and a coating mass sensor.....	414
Figure 5.26:	Schematic of an electromagnetic stabiliser	416
Figure 5.27:	Schematic of a galvannealing treatment tower equipped with induction heating	417
Figure 5.28:	Schematic of the galvannealing induction furnace.....	418
Figure 5.29:	Roll coater.....	425
Figure 5.30:	Schematic diagram of a jet vapour deposition unit for coating a moving strip of steel with zinc	434
Figure 6.1:	Typical process flow for a general galvanising plant.....	439
Figure 6.2:	Principle of tube galvanising.....	440
Figure 6.3:	Material flow sheet for general galvanising plants.....	447
Figure 6.4:	Specific energy consumption (kWh/t of feedstock processed) in batch galvanising.....	456
Figure 6.5:	Specific energy consumption (kWh/t of feedstock processed) in batch galvanising including the yearly production throughput (production/hot dipping bath volume)	457
Figure 6.6:	Specific energy consumption (kWh/t of feedstock processed) for heating of the batch galvanising kettle	458
Figure 6.7:	Specific consumption (kg/t of steel coated) of acidic degreasing solutions in batch galvanising plants.....	459
Figure 6.8:	Specific consumption (kg/t of steel coated) of alkaline degreasing solutions in batch galvanising plants.....	460
Figure 6.9:	Specific HCl consumption (kg/t of steel coated) in pickling in batch galvanising plants ..	461

Figure 6.10:	Specific pickling inhibitors consumption (kg/t of steel coated) in pickling in batch galvanising plants	462
Figure 6.11:	Specific flux agent consumption (kg/t of steel coated) in pickling in batch galvanising plants.....	463
Figure 6.12:	NO _x and CO emissions from heating the galvanising kettle (in mg/Nm ³ at 3 % oxygen)	464
Figure 6.13:	NO _x and CO emissions from feedstock drying (in mg/Nm ³ at 3 % oxygen)	465
Figure 6.14:	HCl emissions from pickling (in mg/Nm ³) in batch galvanising plants.....	466
Figure 6.15:	Dust emissions from hot dipping (in mg/Nm ³) in batch galvanising plants	467
Figure 6.16:	Dust emissions from hot dipping (in mg/Nm ³) in batch galvanising plants using low-fume flux	468
Figure 6.17:	Specific generation of spent alkaline degreasing solution (in kg/t)	469
Figure 6.18:	Specific generation of spent acidic degreasing solution (in kg/t)	470
Figure 6.19:	Specific generation of oily sludge from degreasing solution (in kg/t).....	471
Figure 6.20:	Specific generation of spent HCl from pickling and stripping (in kg/t).....	472
Figure 6.21:	Specific generation of spent flux (in kg/t)	473
Figure 6.22:	Specific generation of bottom dross (in kg/t)	474
Figure 6.23:	Specific generation of zinc ash (in kg/t)	475
Figure 6.24:	Flowsheet for biological degreasing	478
Figure 6.25:	Example flowsheet for evaporative HCl recovery	480
Figure 6.26:	Example mass balance for evaporative HCl recovery	480
Figure 6.27:	Flow chart for removal of zinc from pickling baths	482
Figure 6.28:	Schematic of the solvent extraction process	484
Figure 6.29:	Limiting curve for the operation of open HCl pickling baths.....	487
Figure 6.30:	Extraction systems (lip and lateral hoods) used in open pickling tank operations.....	489
Figure 6.31:	Schematic for an enclosed pretreatment section in batch galvanising	490
Figure 7.1:	Dust emissions from acid recovery (in mg/Nm ³).....	501
Figure 7.2:	HCl emissions from acid recovery (in mg/Nm ³)	502
Figure 7.3:	SO ₂ emissions from acid recovery (in mg/Nm ³).....	503
Figure 7.4:	NO _x emissions from acid recovery (in mg/Nm ³)	504
Figure 7.5:	HF emissions from acid recovery (in mg/Nm ³).....	505
Figure 7.6:	Cadmium emissions (in µg/l) for direct discharges	510
Figure 7.7:	Cadmium emissions (in µg/l) for indirect discharges	511
Figure 7.8:	COD emissions (in mg/l) for direct discharges.....	512
Figure 7.9:	COD emissions (in mg/l) for indirect discharges.....	513
Figure 7.10:	Chromium emissions (in mg/l) for direct discharges.....	514
Figure 7.11:	Chromium emissions (in mg/l) for direct discharges (sorted by steel category)	515
Figure 7.12:	Chromium emissions (in mg/l) for indirect discharges.....	516
Figure 7.13:	Chromium emissions (in mg/l) for indirect discharges (sorted by steel category)	517
Figure 7.14:	Chromium VI emissions (in µg/l) for direct discharges.....	518
Figure 7.15:	Chromium VI emissions (in µg/l) for indirect discharges.....	519
Figure 7.16:	Fluoride emissions (in mg/l) for direct discharges.....	520
Figure 7.17:	Fluoride emissions (in mg/l) for indirect discharges	521
Figure 7.18:	Iron emissions (in mg/l) for direct discharges	522
Figure 7.19:	Iron emissions (in mg/l) for indirect discharges	523
Figure 7.20:	Mercury emissions (in µg/l) for direct discharges	524
Figure 7.21:	Mercury emissions (in µg/l) for indirect discharges	525
Figure 7.22:	Hydrocarbon oil index emissions (in mg/l) for direct discharges	526
Figure 7.23:	Hydrocarbon oil index emissions (in mg/l) for indirect discharges	527
Figure 7.24:	Nickel emissions (in mg/l) for direct discharges	528
Figure 7.25:	Nickel emissions (in mg/l) for direct discharges (sorted by steel category)	529
Figure 7.26:	Nickel emissions (in mg/l) for indirect discharges	530
Figure 7.27:	Nickel emissions (in mg/l) for indirect discharges (sorted by steel category)	531
Figure 7.28:	Oil emissions (in mg/l) for direct discharges	532
Figure 7.29:	Oil emissions (in mg/l) for indirect discharges.....	533
Figure 7.30:	Phosphorus emissions (in mg/l) for direct discharges	534
Figure 7.31:	Phosphorus emissions (in mg/l) for indirect discharges	535
Figure 7.32:	Lead emissions (in µg/l) for direct discharges	536
Figure 7.33:	Lead emissions (in µg/l) for indirect discharges.....	537
Figure 7.34:	Tin emissions (in mg/l) for direct discharges	538
Figure 7.35:	Tin emissions (in mg/l) for indirect discharges	539
Figure 7.36:	Suspended solid emissions (in mg/l) for direct discharges	540
Figure 7.37:	Suspended solid emissions (in mg/l) for indirect discharges	541
Figure 7.38:	TOC emissions (in mg/l) for direct discharges	542

Figure 7.39: TOC emissions (in mg/l) for indirect discharges	543
Figure 7.40: Total suspended solid emissions (in mg/l) for direct discharges	544
Figure 7.41: Total suspended solid emissions (in mg/l) for indirect discharges	545
Figure 7.42: Zinc emissions (in mg/l) for direct discharges	546
Figure 7.43: Zinc emissions (in mg/l) for indirect discharges	547
Figure 8.1: Continuous improvement in an EMS model	550
Figure 8.2: Coil support lined with rubber corresponding to the coil geometry	561
Figure 8.3: Coil support with oil drip trays	561
Figure 8.4: Coil tong with protector	562
Figure 8.5: C-hook magnet for hoisting of coils	562
Figure 8.6: Piler with mandrels for coil manipulation and transport	563
Figure 8.7: Chemical reactions within 100 % Hydrogen Bell Annealing	576
Figure 8.8: Principle of slab preheating using waste gas	580
Figure 8.9: Potential fuel savings with preheating of combustion air	583
Figure 8.10: Schematic of a regenerative burner system	584
Figure 8.11: Schematic of a self-recuperative burner	585
Figure 8.12: Typical exhaust gas recuperators	586
Figure 8.13: Typical compact recuperator	586
Figure 8.14: Schematic of a regenerative burner system in radiant tubes	587
Figure 8.15: Typical recuperative burner in radiant tubes	588
Figure 8.16: Basic schematic of a waste heat recovery boiler	589
Figure 8.17: Example flowsheet for ceramic filtration of degreasing solution	593
Figure 8.18: Principle of heat exchangers	596
Figure 8.19: Principle of submerged combustion	596
Figure 8.20: Different types of pickling tanks	604
Figure 8.21: Flowsheet for activated pickling	607
Figure 8.22: Reverse cascade rinsing at a batch galvanising plant	609
Figure 8.23: Flow sheet for flux regeneration	611
Figure 8.24: Schematic of the electrolytic oxidation process	612
Figure 8.25: Vacuum cooling crystallisation process for H ₂ SO ₄	620
Figure 8.26: Evaporative acid recovery	621
Figure 8.27: Principle of diffusion dialysis	622
Figure 8.28: Fluidised bed HCl acid regeneration process	623
Figure 8.29: Spray roasting HCl acid regeneration process	624
Figure 8.30: Process flowsheet for the production of high-purity oxides	625
Figure 8.31: Spray roasting mixed acid regeneration process	626
Figure 8.32: Principle of salt splitting by bipolar membranes	628
Figure 8.33: Evaporation process for mixed acid regeneration	629
Figure 8.34: Rinsing systems	638
Figure 8.35: Schematic of a low-NO _x burner with internal flue-gas recirculation	653
Figure 8.36: Schematic example of an air-staged low-NO _x burner	654
Figure 8.37: Schematic of a burner equipped with FGR	657
Figure 8.38: Effect of flue-gas recirculation on NO _x emission	657
Figure 8.39: Example of the relation of NO _x and air preheating temperature for a natural-gas-fired walking beam furnace	660
Figure 8.40: Example of the relation of NO _x and air preheating temperature for a (mainly) COG-fired reheating furnace	660
Figure 8.41: Example of the relation of NO _x and air preheating temperature for a COG-fired reheating furnace	661
Figure 8.42: Design principles for closed pickling tanks	666
Figure 8.43: Principle of packed scrubbers	668
Figure 8.44: Principle of a cross-flow scrubber	669
Figure 8.45: Principle of plate scrubbers	670
Figure 8.46: Principle of fume filter	671
Figure 8.47: Schematic for injecting H ₂ O ₂ into pickling acid recirculation loop	678
Figure 8.48: Schematic for injecting H ₂ O ₂ into pickling baths via a sparge pipe	678
Figure 8.49: Bilateral peripheral exhaust with auxiliaries	687
Figure 8.50: Lip extraction at a batch galvanising plant	687
Figure 8.51: Stationary enclosure	689
Figure 8.52: Moveable enclosure with vertical moving side walls	690
Figure 8.53: Principle of ultrafiltration	702
Figure 8.54: Spent degreasing solution flow (example of a continuous annealing line)	703
Figure 8.55: Schematic of a rotary kiln plant for thermal treatment of oily mill scale	709

Figure 8.56: Picture of a rotary kiln for thermal treatment of oily mill scale at an ArcelorMittal integrated plant	709
Figure 8.57: Thermal treatment (i.e. calcining and sintering) of hydroxide sludge obtained after neutralisation of spent acids.....	714
Figure 11.1: Schematic of a generic waste water system.....	799
Figure 11.2: Schematic of different line layouts in a common waste water treatment plant.....	799

SCOPE

The BREF for the Ferrous Metals Processing Industry concerns the following activities specified in Annex I to Directive 2010/75/EU:

- 2.3 Processing of ferrous metals:
 - (a) operation of hot rolling mills with a capacity exceeding 20 tonnes of crude steel per hour;
 - (c) application of protective fused metal coats with an input exceeding 2 tonnes of crude steel per hour; this includes hot dip coating and batch galvanising.
- 2.6 Surface treatment of ferrous metals using electrolytic or chemical processes where the volume of the treatment vats exceeds 30 m³, when it is carried out in cold rolling, wire drawing or batch galvanising.
- 6.11 Independently operated treatment of waste water not covered by Directive 91/271/EEC, provided that the main pollutant load originates from the activities covered by this BREF.

This document also covers the following:

- Cold rolling and wire drawing if directly associated with hot rolling and/or hot dip coating.
- Acid recovery, if directly associated with the activities covered by this BREF.
- The combined treatment of waste water from different origins, provided that the waste water treatment is not covered by Directive 91/271/EEC and that the main pollutant load originates from the activities covered by this BREF.
- Combustion processes directly associated with the activities covered by this BREF provided that:
 1. the gaseous products of combustion are put into direct contact with material (such as direct feedstock heating or direct feedstock drying), or
 2. the radiant and/or conductive heat is transferred through a solid wall (indirect heating)
 - without using an intermediary heat transfer fluid (this includes heating of the galvanising kettle), or
 - when a gas (e.g. H₂) acts as the intermediary heat transfer fluid in the case of batch annealing.

This document does not cover the following:

- metal coating by thermal spraying;
- electroplating and electroless plating; this may be covered by the BREF for Surface Treatment of Metals and Plastics (STM).

Other reference documents which could be relevant for the activities covered by this BREF include the following:

- Iron and Steel Production (IS);
- Large Combustion Plants (LCP);
- Surface Treatment of Metals and Plastics (STM);
- Surface Treatment using Organic Solvents (STS);
- Waste Treatment (WT);
- Monitoring of Emissions to Air and Water from IED Installations (ROM);
- Economics and Cross-Media Effects (ECM);
- Emissions from Storage (EFS);
- Energy Efficiency (ENE);
- Industrial Cooling Systems (ICS).

1 GENERAL INFORMATION ON THE FERROUS METALS PROCESSING INDUSTRY

The hot and cold forming part of the ferrous metal processing sector comprises different manufacturing methods, like hot rolling, cold rolling and drawing of steel. A great variety of semi-finished and finished products with different lines of production are manufactured.

Literature dealing with the ferrous metals sector uses different ways of splitting and structuring the sector and for delivering data. Some reports distinguish with regard to the forming process: hot - cold; or with regard to the shape of the final product: flat - long.

Others (e.g. NACE¹) separate the sector into groups: iron and steel production (including most of the hot and cold rolled products as well as continuous coated strip), manufacture of steel tubes and 'other first processing of steel' (cold drawing, cold rolling of narrow strip, wire drawing, etc.).

To put together general information on the sector, statistical data (productivity, number/size of plants, distribution, etc.) and economic information is difficult as most of the available sources for data use a different basis and split the sector differently, thus making it impossible to compare the given data.

To present the general information on the hot and cold forming sector in this BREF, an outline in accordance with the manufactured products, as shown in Figure 1.1, was chosen.

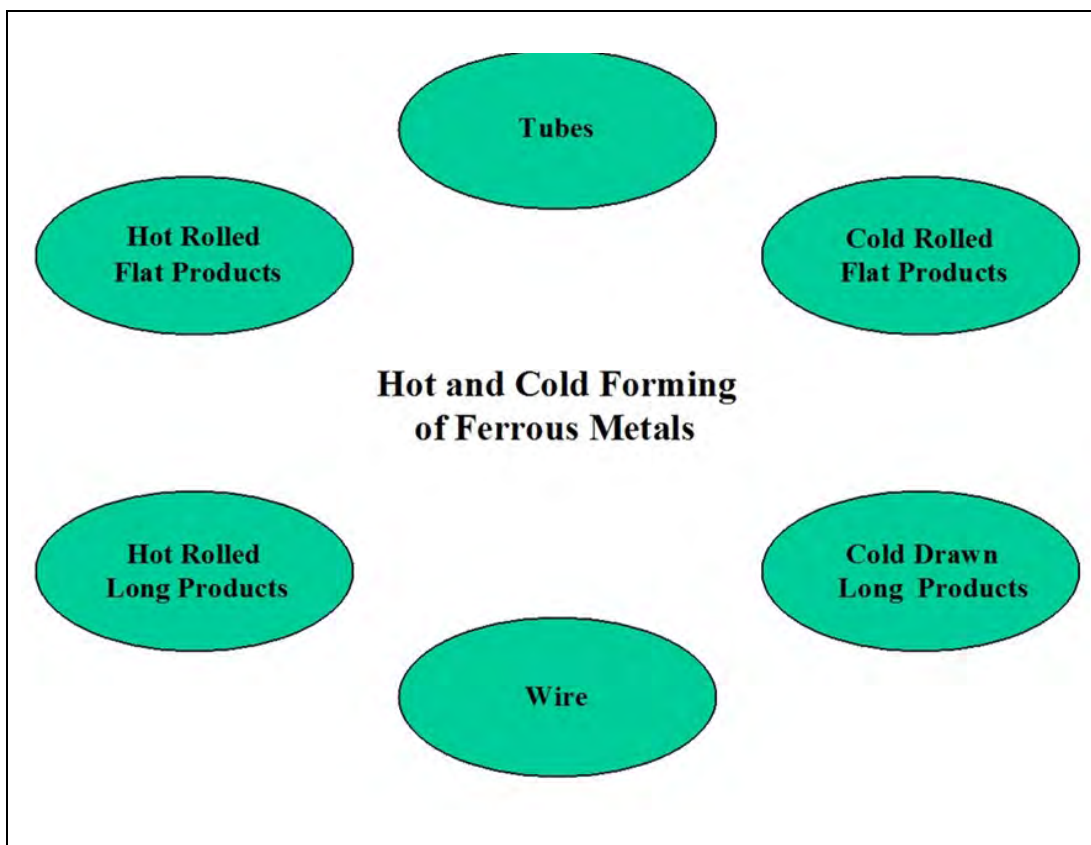


Figure 1.1: Hot and cold formed products covered by this BREF

¹ General industrial classification of economic activities within the European Community.

The ferrous metal processing sector also includes processes that apply coatings of non-ferrous metals, e.g., zinc, to the ferrous metal products shown in Figure 1.1. These coatings are often applied on a continuous basis (often associated with the production of the ferrous product) as is the case for continuous hot dip coating of sheets and wire galvanising. Ferrous metal products or fabricated steel components are also galvanised in batch processes (batch galvanising), usually as a sub-contract operation, within the batch galvanising sector.

2 HOT ROLLING

2.1 General information on hot rolling

2.1.1 Hot rolled flat products

Table 2.1 presents production data for individual flat products and for the total production of flat products in 2019 in Europe. Data for the following hot rolled flat products are reported:

- **Wide flats:** hot rolled flat products with a width over 150 mm up to and including 1 250 mm and a thickness generally over 4 mm. They are always supplied in lengths, i.e. not coiled. A special requirement is that the edges are square. Wide flats are rolled on the four sides (or in box passes).
- **Narrow strips:** hot rolled strips in widths typically up to 600 mm which, immediately after the final rolling pass, are wound into coils. Production is measured immediately on completion of the rolling cycle, i.e. before trimming or rectification.
- **Wide strips:** hot rolled strip in widths typically above 600 mm.
- **Heavy plates:** heavy plates produced in heavy plate mills, e.g. quarto plate.

Table 2.1: Production of flat products in Europe in 2019

	Wide flats [thousand t]	Narrow strips [thousand t]	Wide strips [thousand t]	Heavy plates [thousand t]	Total HR flat products [thousand t]
Austria	0	0	4 593.2	678.7	5 271.9
Belgium	0	11.4	8 540.5	425.2	8 990.8
Bulgaria	0	0	0	242.1	242.1
Czech Republic	41.2	0	440.5	397.6	879.4
Denmark	0	0	0	548.5	548.4
Finland	0	0	1 649.3	400.3	2 049.6
France	0	0	9 065.7	677.1	9 759.5
Germany	81.8	949.6	18 903.0	2 695.2	22 656.2
Greece	0	0	0	0	0
Hungary	0	0	1 528.2	0.2	1 528.4
Italy	167.2	0	8 874.7	1 934.6	11 005.5
Luxembourg	0	0	0	0	0
Netherlands	0	0	6 111.8	0	6 129.2
Poland	0	0	2 590.6	164.8	2 755.5
Portugal	0	0	0	0	0
Romania	0	0	1 332.2	660.0	1 992.2
Slovakia	0	0	3 413.0	0	3 412.9
Slovenia	0	0	106.9	237.7	344.6
Spain	0	0	3 887.6	463.5	4 391.0
Sweden	0	0	2 541.1	583.1	3 124.2
UK	278.6	27.2	3 183.1	221.6	3 710.5
Total	568.8	988.2	76 761.4	10 330.6	88 792.5

NB: Reference year 2019.
Source: [1. EUROFER 2021]

Regarding the total production of HR flat products, Germany is the largest manufacturer with more than double the production of the next highest producers (Italy, France, Belgium and the Netherlands). The vast majority of HR flat products is wide strips.

2.1.2 Hot rolled long products

Table 2.2 presents production data for individual long products and for the total production of long products in 2019 in Europe. Data for the following hot rolled long products are reported:

- **Rails and accessories:** include both heavy and light railway, tramway rails and products for other rail systems (e.g. crane rails, bridge rails, grooved rails), as well as hot rolled accessories (e.g. sleepers, fish plates, base plates).
- **Bars for reinforcement of concrete:** round cross sections, 6-40 mm in diameter, mostly with ribs on their surface.
- **Merchant bars:** round, square, rectangular, hexagonal, octagonal, L-shaped, [-shaped, I-shaped cross sections smaller than 1 600 mm².
- **Heavy sections:** whole production of beams and sheet piling sections.
- **Wire rods:** hot rolled products with circular cross sections with a diameter of 5 mm to 14 mm.

Table 2.2: Production of long products in Europe in 2019

	Rails and accessories [thousand t]	Bars for reinforcement [thousand t]	Merchant bars [thousand t]	Heavy sections [thousand t]	Wire rods [thousand t]	Total HR long products [thousand t]
Austria	536.3	250.0	189.7	11.5	494.5	1 482.1
Belgium	0	0	0	0	557.2	557.2
Bulgaria	0	686.0	0	0	0	686.0
Czech Republic	268.0	154.4	680.0	166.3	1 506.6	2 897.3
Denmark	0	0	131.4	0	0	131.4
Finland	0	0	168.3	0	0	168.3
France	288.3	743.2	958.6	0	1 677.6	3 667.8
Germany	5.3	1 798.4	2 430.7	1 771.2	5 610.8	11 622.7
Greece	0	981.6	0	0	309.9	1 291.5
Hungary	0	332.8	0	0	0	332.8
Italy	182.7	3 015.5	3 432.7	695.9	5 001.8	12 328.8
Luxembourg	49.8	0	68.0	1 427.2	0	2 020.6
Netherlands	0	0	0	0	127.8	127.8
Poland	318.5	1 815.0	668.2	1 168.8	1 066.1	5 174.0
Portugal	0	996.1	0	0	785.6	1 781.7
Romania	0	142.8	61.4	110.3	39.5	354.1
Slovakia	0	0	0	0	0	0
Slovenia	0	0	179.6	0	0	179.6
Spain	272.2	1 510.2	1 401.0	2 661.2	2 937.0	8 781.6
Sweden	0	0	463.0	0	33.3	496.3
UK	172.0	342.0	693.7	801.6	775.5	2 785.1
Other national producers	0	0	40.2	5.4	0	45.6
Total	2 093.1	12 768.3	11 566.5	8 819.4	20 923.7	56 912.3

NB: Reference year 2019.

Source: [1. EUROFER 2021]

The two major manufacturing countries are Italy and Germany, followed by Spain and Poland. The largest part of the long products sector in tonnage terms is the production of wire rods which account for roughly a third of the total production, followed by bars for reinforcement of concrete and merchant bars with an approximate share of one fifth of the production each.

2.1.3 Hot rolling mill capacity in Europe

In 2021, a total of 302 hot rolling mills were in operation in the EU-27 and the United Kingdom (including hot rolling mills for flat and long products). The total number and nominal capacity (expressed in t/h) of these plants are given in Table 2.3.

Table 2.3: Number and nominal capacity (expressed in t/h) of hot rolling mills operating in the EU-27 and the United Kingdom in 2021

Rolling mill type		Total	Nominal capacity range (t/h)											
			0-19	20-39	40-59	60-79	80-99	100-119	120-149	150-199	200-299	300-399	400-499	>500
Blooming /slabbing mill	Combined nominal capacity (t/h)	563	65	34	87	63	0	108	0	0	205	0	0	0
Blooming /slabbing mill	Number of installations	11	5	1	2	1	0	1	0	0	1	0	0	0
Billet / heavy bar mill	Combined nominal capacity (t/h)	723	154	107	199	80	183	0	0	0	0	0	0	0
Billet / heavy bar mill	Number of installations	23	13	3	4	1	2	0	0	0	0	0	0	0
Heavy section mill	Combined nominal capacity (t/h)	1 027	25	135	188	131	186	225	137	0	0	0	0	0
Heavy section mill	Number of installations	17	2	4	4	2	2	2	1	0	0	0	0	0
Medium section mill	Combined nominal capacity (t/h)	1 275	58	152	217	200	537	112	0	0	0	0	0	0
Medium section mill	Number of installations	24	5	5	4	3	6	1	0	0	0	0	0	0
Light section / bar mill	Combined nominal capacity (t/h)	4 725	358	810	1204	1082	712	410	148	0	0	0	0	0
Light section / bar mill	Number of installations	122	47	24	23	15	8	4	1	0	0	0	0	0
Wire rod mill	Combined nominal capacity (t/h)	2 195	10	134	253	630	354	333	137	342	0	0	0	0
Wire rod mill	Number of installations	31	2	5	5	9	4	3	1	2	0	0	0	0
Hot strip mill	Combined nominal capacity (t/h)	11 949	32	0	105	0	0	428	422	702	1 153	2 158	2 348	4 600
Hot strip mill	Number of installations	39	2	0	2	0	0	4	3	4	5	6	5	8
Plate mill	Combined nominal capacity (t/h)	2 077	83	137	194	572	349	103	137	502	0	0	0	0
Plate mill	Number of installations	35	9	5	4	8	4	1	1	3	0	0	0	0

Source: [1, EUROFER 2021]

2.1.4 Hot rolled tubes

The EU Steel Tube Industry represents an average yearly production of 12.2 million tons and a turnover of more than 12 billion €. The EU steel tube industry is fully part of the steel industry and uses about 10% of the EU crude steel production.

In 2019, the EU 27 Steel Tube Industry comprised 150 production facilities in 17 countries of the EU employing a workforce of 55 000 direct employees.

Table 2.4 summarises global steel tube market data for the period 2019-2020. The EU represents 7% of the world steel production of tubes, whereas China is representing more than 50% of the world production.

Table 2.4: Global steel tube market (2019-2020)

	Total [Million t]	Seamless [Million t]	Small welded [Million t]	Large welded [Million t]
World steel tube production	172	43	107	22
EU27 steel tube production	12.2	3.6	7.7	0.9
EU27 steel tube consumption	11.7	2.4	8.4	0.9
EU27 steel tubes exports	3.1	1.7	0.9	0.5
EU27 steel tubes imports	2.6	0.5	1.6	0.5
World steel production	1 875	NA	NA	NA
EU steel production	150	NA	NA	NA
NA: not available				
Source: [2. EUROFER 2021]				

Steel tubes cover three product categories, which differ considerably in terms of the manufacturing process, raw materials, and investment requirements. These categories are classified as:

- seamless tubes;
- large welded steel tubes with a circular cross section of over 406.4 mm in outside diameter;
- small welded steel tubes with a circular cross section up to and including 406.4 mm in outside diameter together with welded steel tubes with a non-circular cross section of any diameter.

The seamless process is basically a hot extrusion process from a steel billet. Hot finished seamless tubes might be further processed by cold drawing. Welded process is usually a cold forming process (at the exception of half a dozen mills in EU27) from a steel flat product, plate, coil or strip.

The industry is concentrated in the seamless hot finished tubes with a total of 30 mills operating in 10 countries belonging to 15 groups. The seamless cold drawn production, as well as the welded production is far more dispersed with a significant number of small independent producers.

About 30 % of the tubes produced are seamless tubes, and of the remaining 70 % welded tubes about 7 % have a large diameter. The majority of the total steel tube sector is small diameter tubes with a share of 63 %. The steel tube industry supplies a wide range of products to a wide diversity of end using sectors:

- Energy, oil and gas exploitation and transport, power generation and petrochemicals;
- Construction;
- Mechanical engineering and machine building;
- Transport, including automotive industry;
- Consuming goods, including metallic furnitures, bicycles, radiators, toys.

Table 2.5 shows the steel tube production for individual Member States in 2019.

Table 2.5: Steel tube production in 2019

Country	Seamless tubes [thousand t]	Welded tubes [thousand t]	Total tubes [thousand t]
Austria	427	219	645
Belgium	0	0	0
Bulgaria	0	153	153
Croatia	0	0	0
Cyprus	0	0	0
Czech Republic	259	247	506
Denmark	0	0	0
Estonia	0	0	0
Finland	0	294	294
France	274	214	488
Germany	1 112	1 221	2 333
Greece	0	448	448
Hungary	0	69	69
Ireland	0	0	0
Italy	564	3 478	4 042
Latvia	0	16	16
Lituania	0	0	0
Malta	0	0	0
Netherlands	0	249	249
Poland	105	649	754
Portugal	0	0	0
Romania	423	134	557
Slovak Republic	178	55	233
Slovenia	0	0	0
Spain	195	1 095	1 290
Sweden	81	15	95
<i>Source: [2, EUROFER 2021]</i>			

2.2 Applied processes and techniques in hot rolling

2.2.1 Process overview

In hot rolling, the size, shape and metallurgical properties of the steel slabs, blooms, billets or ingots are changed by repeatedly compressing the hot metal (temperature ranging from 1 050 °C to 1 300 °C) between electrically powered rollers. The steel input for hot rolling differs in form and shape, depending on the process route and on the product to be manufactured.

Cast ingots, predominantly with a square cross section, are used for the manufacture of slabs and blooms in slabbing/blooming mills. Slabs and blooms are further processed to plates or strips in other rolling mills. The use of cast ingots and slabbing/blooming is decreasing as continuous casting has made this step obsolete. At the time of writing this document, more than 98 % of the crude steel produced in Europe is cast continuously into semi-finished products such as slabs, blooms or billets [3, EUROFER 2020]. Only a minor part is cast into discrete moulds to produce ingots for some special products (e.g. heavy plates).

Slabs (400–2 500 mm wide and 40–500 mm thick) are semi-finished, continuous cast products for the rolling of flat products. These include **thin slabs** (840 mm up to 1 560 mm wide and 50 mm to 60 mm thick).

Billets (of a square or rectangular shape with cross sections of 2 500 mm² to 14 400 mm² (50 mm x 50 mm to 120 mm x 120 mm) and **blooms** (of a square or rectangular shape with cross sections of 14 000 mm² up to approximately 100 000 mm² (120 mm x 120 mm up to 250 mm x 400 mm) are semi-finished continuous cast products used for the rolling of long products.

Beam blanks (with dimensions of 170 mm x 240 mm up to 500 mm x 1120 mm) are continuously cast to near-net-shape. Beam blanks are used for rolling of long products. [4, EUROFER 1998]

Hot rolling mills usually comprise the following process steps:

- storage and handling of input;
- surface rectification (scarfing, grinding) and conditioning (cutting to size) of the input;
- reheating to rolling temperature;
- descaling;
- rolling (roughing including width reduction, rolling to final dimension and properties);
- cooling;
- coiling (in the case of strip material);
- finishing (trimming, slitting, cutting).

Products obtained from hot rolling are usually classified in two basic types according to their shape: flat and long products. Tubes are also covered by the term ‘long product’ in this document.

Figure 2.1 shows an overview of products manufactured for various purposes and applications.

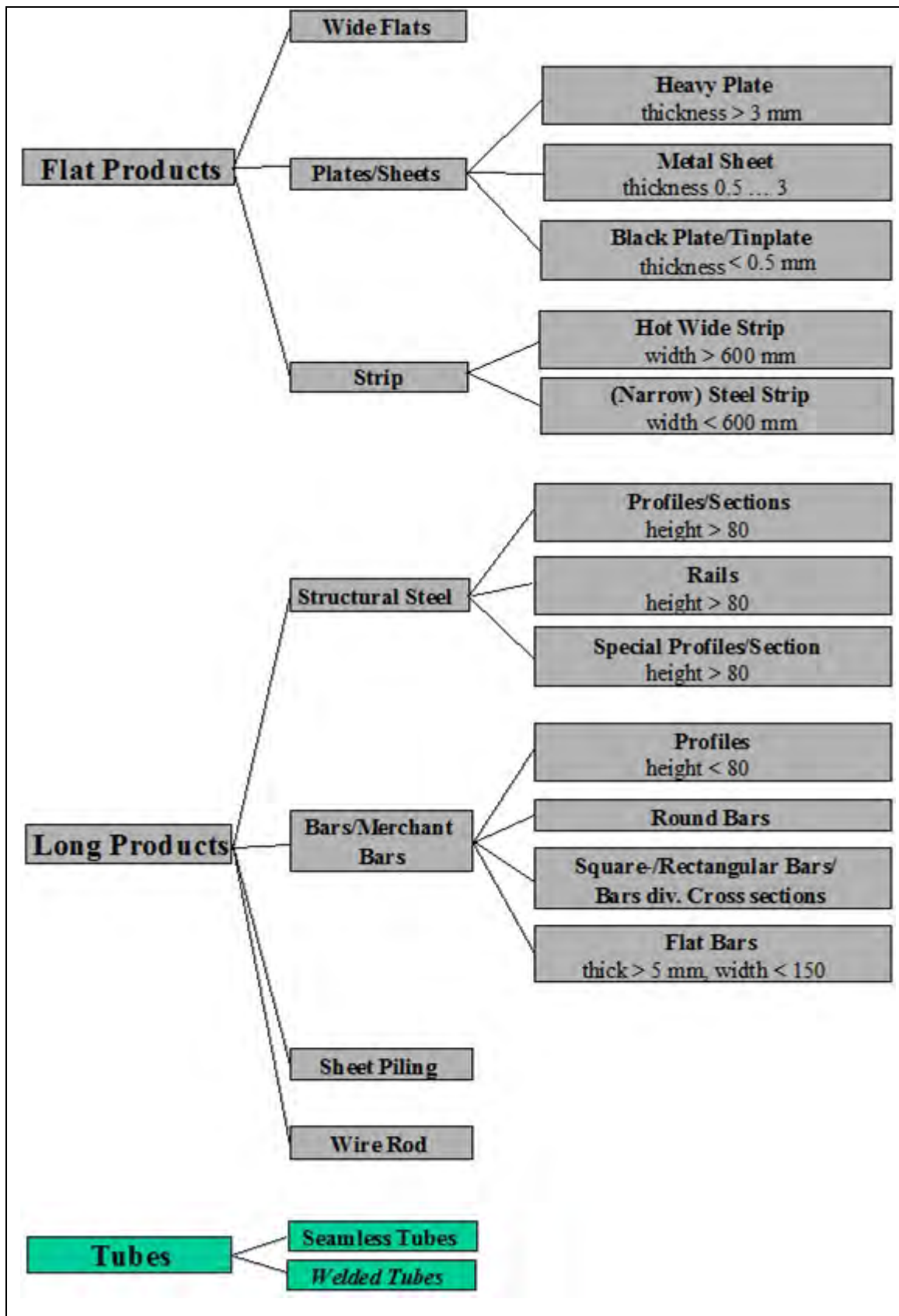


Figure 2.1: Overview of hot rolled products

Hot rolling mills are classified by the type of product that they produce and by their design features. The following chapters give an insight into the different mill layouts and manufacturing sequences. More detailed information on the individual processing steps, which are often similar in different mills, is given thereafter.

2.2.1.1 Blooming/Slabbing mills

Blooming and slabbing mills are used to roll cast ingots into semi-finished products, like blooms and slabs, for further processing in other mills. The raw material is heated in soaking pits to around 1 300 °C and subsequently formed on heavy two-high reversing stands in 15–30 rolling passes.

The material to be rolled is moved along roller tables, positioned with the aid of manipulators, and fed into the roll gap. The material is repeatedly rotated 90° on its long axis during the series of passes.

The main difference between blooming and slabbing stands is the greater height of the stands used for rolling slabs. This is associated with the product characteristics; as slabbing mills are mainly used to roll flat semi-finished products they require a bigger lift height of the upper rolls.

Another rolling system is the universal slabbing stand. Working pairs of rolls are arranged horizontally and vertically in succession. The vertical rolls form the narrow sides.

The rolled semi-finished products are cropped with shears at both ends, and divided into ordered lengths. Surface defects of the product may be removed by flame descaling (scarfing). [[5. Ullmann's 1994](#)]

With the growth of continuously cast products, the number and importance of slabbing and blooming mills has decreased. In 2019, only 11 blooming/slabbing mills remain in operation (see Table 2.3).

2.2.1.2 Hot strip mills

For the production of hot strip, the heated slab - after descaling - passes the roughing mill, where it is reduced from a thickness of approximately 120–300 (500) mm to approximately 20–50 mm (transfer bar). Roughing can also include a reduction in width.

This roughing is done either in several passes through an individual rolling stand by repeated reversing, or in a continuous pass through several roughing stands. The designations of strip mills (semi-continuous hot strip mill, 3/4 continuous hot strip mill and continuous hot strip mill, see Figure 2.2) originate from this plant configuration. Depending on the configuration, the range of production is from 1.5 Mt/year up to 5.5 Mt/year.

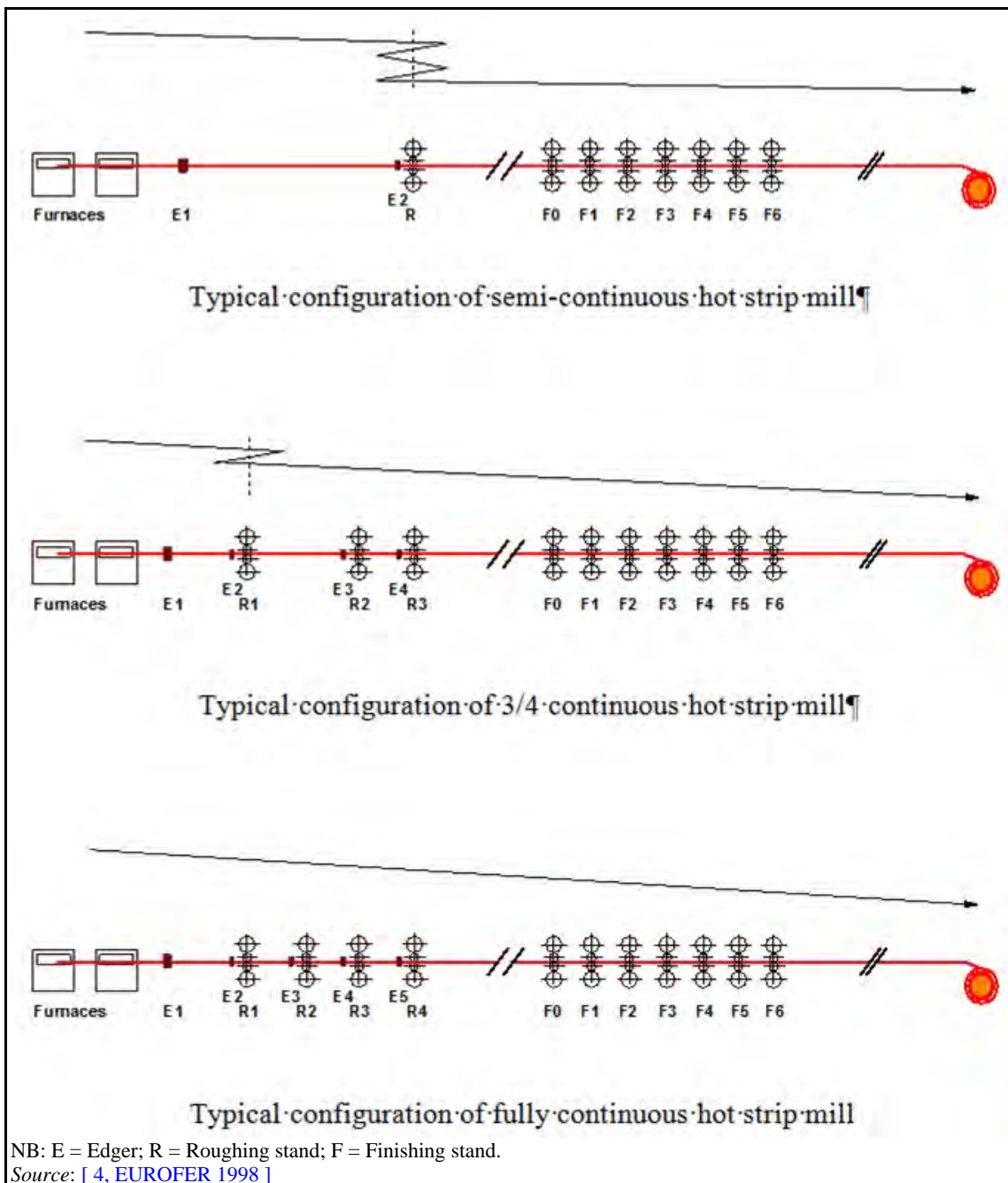


Figure 2.2: Typical designs for hot strip mills

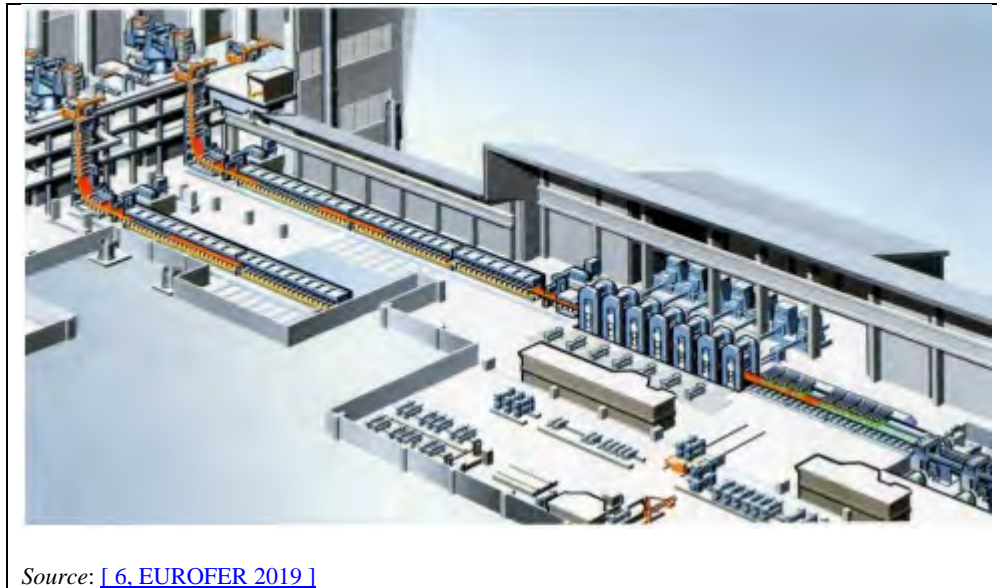
The material reduced to a transfer bar is directed to the finishing train via an intermediate roller table, which in some cases is combined with a so-called coil box. Before entering a train of rolling stands for thickness reduction to the final size (between 1.2 mm and approximately 20 mm), the transfer bar is cropped. Temperature-controlled rolling in the finishing train, involving controlled strip cooling installed at the delivery roller table, provides the requested technological parameters (strength, toughness, etc.) of the hot strip. At the end of the rolling mill, the finished product is wound up in a coil.

Hot strip, which is not foreseen for further processing in the cold mills, is partly sold with rolled strip edges, but depending on the planned external use the strip has to be conditioned. This coil finishing includes side trimming, cutting to small bands on slitting lines and cutting into sheets. [4, EUROFER 1998]

Coupled thin slab caster and hot strip mill

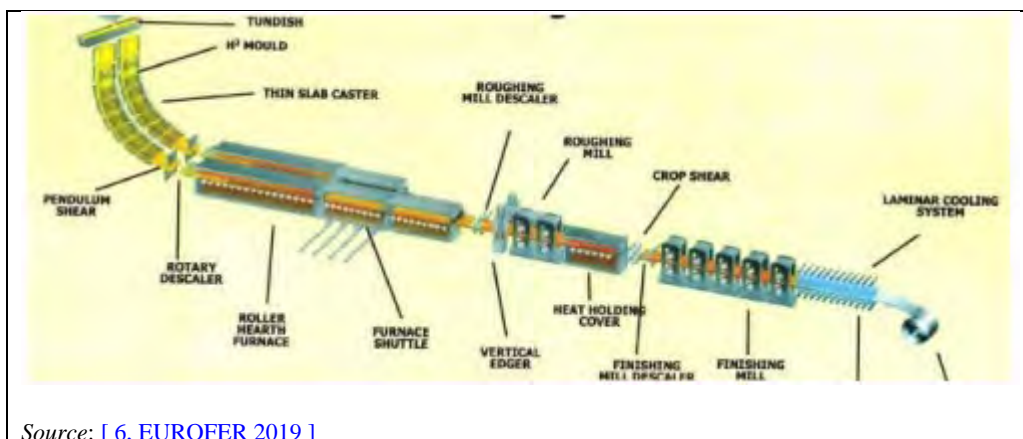
Over the past 20 years, new types of hot strip mills have been implemented. The conventional slab as input material with a thickness range of 200-250 mm is replaced by a thin slab with a thickness range of 45-70 mm. In this case, a thin-slab continuous reheating furnace is usually located after the thin slab continuous caster, followed by a conventional hot finishing mill. Such schemes provide increased throughput and reduced energy consumption in the reheating furnaces.

There are several configurations of coupled thin slab caster and hot strip mill (see Figure 2.3 to Figure 2.5). Depending on the configuration, the range of production is from 1 Mt/year up to 3 Mt/year. [6, EUROFER 2019]



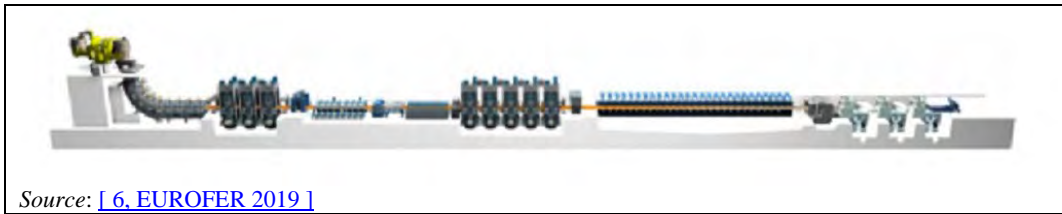
Source: [6, EUROFER 2019]

Figure 2.3: Hot strip production with two thin slab casters, two reheating furnaces and one finishing mill; capacity 2 Mt/yr



Source: [6, EUROFER 2019]

Figure 2.4: Hot strip production with two thin slab casters, two reheating furnaces, one continuous roughing mill, bar heater and finishing mill; capacity 3 Mt/yr



Source: [6. EUROFER 2019]

Figure 2.5: Hot strip production with one thin slab caster directly coupled with one continuous roughing mill, inductive bar heater and endless or semi-endless finishing mill; capacity 2 Mt/yr

Steckel mill

A special method of hot strip production is rolling in so-called Steckel mills. Here the raw material is usually processed into strip by reversing through a roughing stand and a finishing stand, in some cases even by reversing through one stand only.

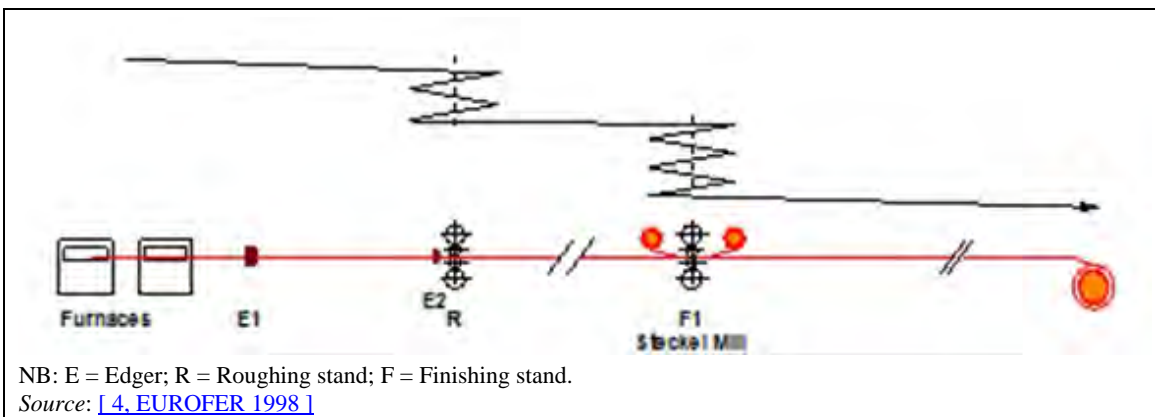
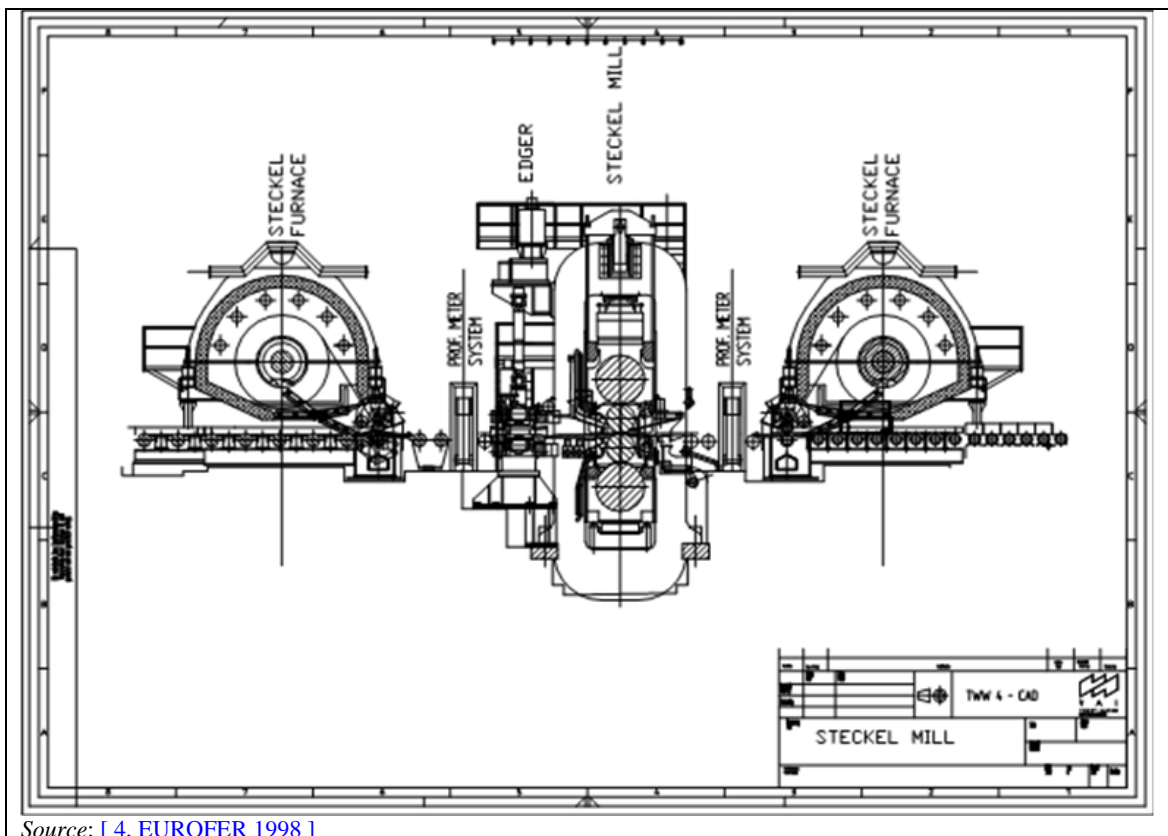


Figure 2.6: Typical Steckel mill configuration

To keep the heat losses during the rather long forming process within reasonable limits and to handle the relatively long strip more easily, heated coiling devices referred to as Steckel coilers are attached on both sides of the rolling stand (finishing stand), where the rolled stock is temporarily stored.



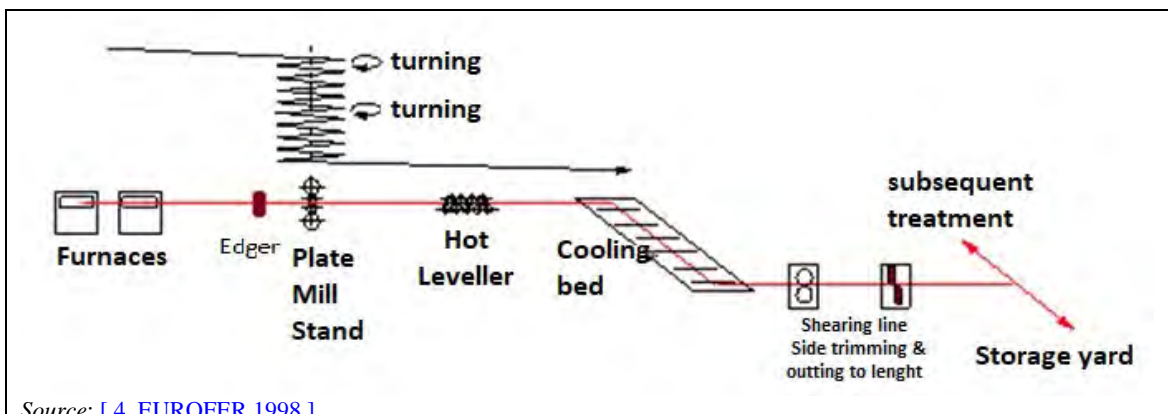
Source: [4, EUROFER 1998]

Figure 2.7: Steckel mill with coiling furnaces

2.2.1.3 Plate mills

Production of heavy plates (thickness between 5.0 mm and 380 mm, width up to 5.2 m) is done by reversing operation at one or two mill stands or in tandem operation. The interest of having two horizontal stands is to increase the production capacity (by around 50 % compared to a single stand) and to improve the capability of thermo-mechanical rolling schedules. [3, EUROFER 2020], [6, EUROFER 2019]

After rolling, the plates are placed on a cooling bed (cross transfer) and cooled to room temperature and/or temperatures down to maximum 500 °C for further processing. [4, EUROFER 1998]



Source: [4, EUROFER 1998]

Figure 2.8: Typical plate mill configuration with one 4-high horizontal rolling stand

In special cases, the rolled product is heat-treated by water cooling systems (e.g. water curtains) immediately after hot rolling. Hot and/or cold levellers are arranged before or after the cooling bed to straighten the plates.

After the cooling process on the cooling bed, secondary treatment of the sheets is performed in the finishing shops (shearing, side trimming cutting to length). A part of the production is subjected to a subsequent heat treatment prior to shipment. Such treatments include annealing, spheroidise annealing, stress relieving, normalising, quenching and tempering.

Clads

Special products such as multi-layer plates (clads) require a separate preparation and rolling technique (mainly a two-heat rolling operation). In such products, a corrosion-resistant surface material is permanently bonded to lower-cost, possibly stronger, carbon steel.

The first step involves the fabrication of 'sandwiches' which consist of plates of the cladding and the backing materials with thickness in the exact proportion to produce the required plate size with the percentage of metals ordered. The assembly is then rolled to the desired gauge, width and length, with the two materials becoming permanently bonded because of the high rolling pressure.

In the rolling operation, drafts are usually limited and the finishing temperatures are carefully controlled. In some cases the sandwiches are rolled in a first stage into slabs, cut to required sizes and, in a second heat, final rolled either in hot strip mills or in the plate mill. Sometimes heat treatments are required to produce the desired corrosion resistance and physical properties, the resultant scale being removed by sand or shot blasting. [4, EUROFER 1998]

2.2.1.4 Bar and rod mills

Bars and rods (wire rods) constitute hot rolled products of relatively small cross sections produced in coiled or straight form. For the rolling operation, profiled rolls are in use to give the steel its desired final shape.

Wire rods

Wire rods generally have circular cross sections with a diameter of 5 mm to 14 mm. Larger cross sections and different section shapes such as oval, square, hexagonal, octagonal, etc. can also be rolled in wire rod mills using adequately shaped rollers. Hot rolled wire rod is mainly used for further processing in cold drawing or cold rolling.

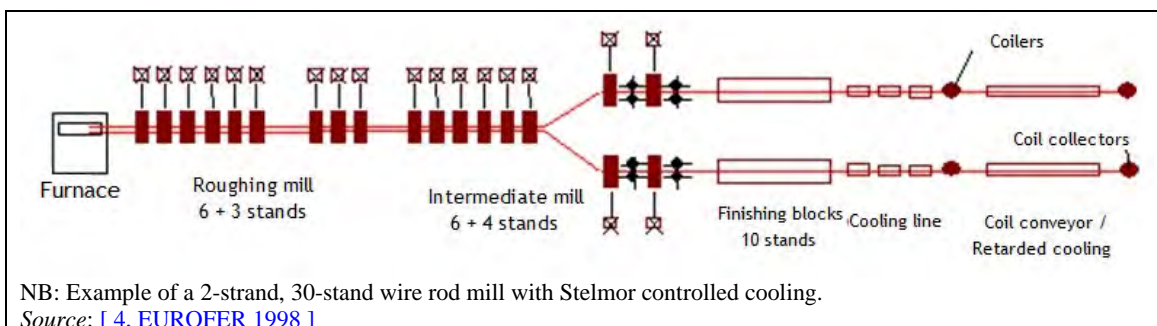


Figure 2.9: Typical layout of a wire rod mill

The billets fed into rod mills are heated to hot rolling temperature in pusher or walking beam furnaces. A descaling system is installed between the furnace exit and the first rolling stand.

Rod mills are continuous mills with roughing, intermediate and finishing sections. The rolling stands are two high and their number is generally in excess of 25, depending on the cross section of the billets feeding the mill (80–155 mm). Roughing and intermediate sections may be multi-strand (up to four strands), while finishing sections are always single-stranded.

Crop shears are installed between the different sections of the mill and are used to provide a clean cut for improved introduction into the following roll stand. Crop shears are also used to cut the bar engaged in the rolling process in case of an incident downstream in the mill.

In-line heat treatment of the wire rod is performed with water cooling ramps located between the final rolling stands and the coilers, followed by air cooling of the coils laid on conveyor belts. Controlled airflow gives the wire rod the desired microstructure for further processing (Stelmor[®] cooling). [4, EUROFER 1998]

Bars

Hot rolled bars include basically two types of steel products, **merchant steels** or engineering steels with round, square, rectangular, hexagonal, octagonal, L-shaped, [-shaped, I-shaped cross sections smaller than 1 600 mm² and **concrete reinforcing bars** (re-bars) with round cross sections, 6–40 mm in diameter, mostly with ribs on their surface.

Bar rolling mills are similar to the first sections of wire rod rolling mills. They generally have single-strand two-high mills with roughing, intermediate and finishing groups followed by shears that cut the hot rolled product to long bars, which are then conveyed to a cooling bed. High-capacity mills are all continuous with alternating horizontal and vertical stands, while lower capacity mills are of the ‘open’ type.

After cooling, the bars are cut to commercial lengths and may be straightened by a cold straightening machine.

Re-bars are often heat-treated in-line by intensive water-cooling to obtain a high tensile strength. A different way for increasing the tensile strength of re-bars is a mechanical treatment after cooling: The bars are deformed by torsion beyond their yield strength until the desired tensile strength is obtained. [4, EUROFER 1998]

Cold drawing of steel bars

Cold drawing concerns the manufacture of steel bars or sections by cold drawing, grinding or peeling of hot rolled steel bars into ‘bright steel bars’, with the form and characteristics required by the users. Cold finishing during cold drawing operations hardens and increases the tensile strength of the steel, while at the same time reducing the ductility, which may require an annealing treatment of the product after drawing. Bright steel bars mainly have a circular, square, rectangular or hexagonal cross-section, but all kinds of cross-sections can be produced according to demand. Products are non-alloy steel bars, alloy steel bars of different grades including high-speed steel and other tool steel and shapes and sections of different steel grades. [7, COM 1997]

Bright steel bars are used by industries such as the manufacture of motor vehicles, machinery, electrical goods and other industries, where high-quality basic material is compulsory.

2.2.1.5 Structural/Section mills

Like most other types of mills, section rolling mills are divided into roughing, intermediate and finishing stands, preceded by a descaling machine installed between the reheating furnace and the roughing mill.

Roughing stands are generally reversing, two-high stands. The rolls have several sets of profiles, which are used in sequence. The upper roll can be moved vertically in order to progressively reduce the gap between the rolls and thus reduce the passing section.

Cropping shears or hot saws are generally installed between the different sections of the mills and are used to provide a clean-cut bar end to facilitate the introduction into the following rolling stand.

On leaving the finishing stand or train, the bars are cut to cooling bed length or to commercial length by saws. After cooling on the cooling bed, the bars are straightened on mechanical or hydraulic straightening machines and cut to length by saws as required. [4, EUROFER 1998]

To yield the different profile shapes required for sections/structures, either duo-stands with two grooved rolls or 'universal' stands with two horizontal and two vertical rolls are used as shown in Figure 2.10 and Figure 2.11.

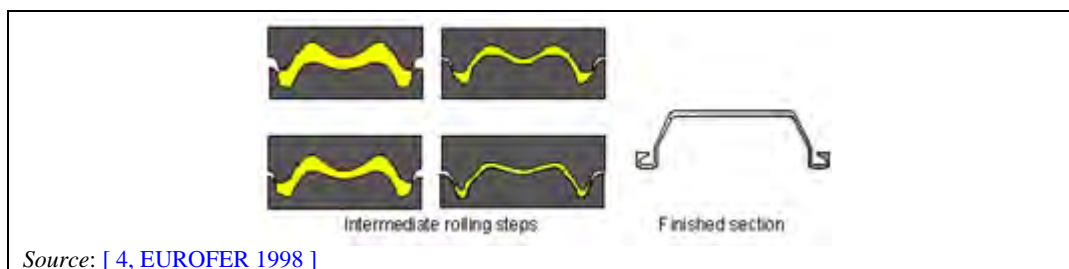


Figure 2.10: Profiled rolls for sheet piling sections

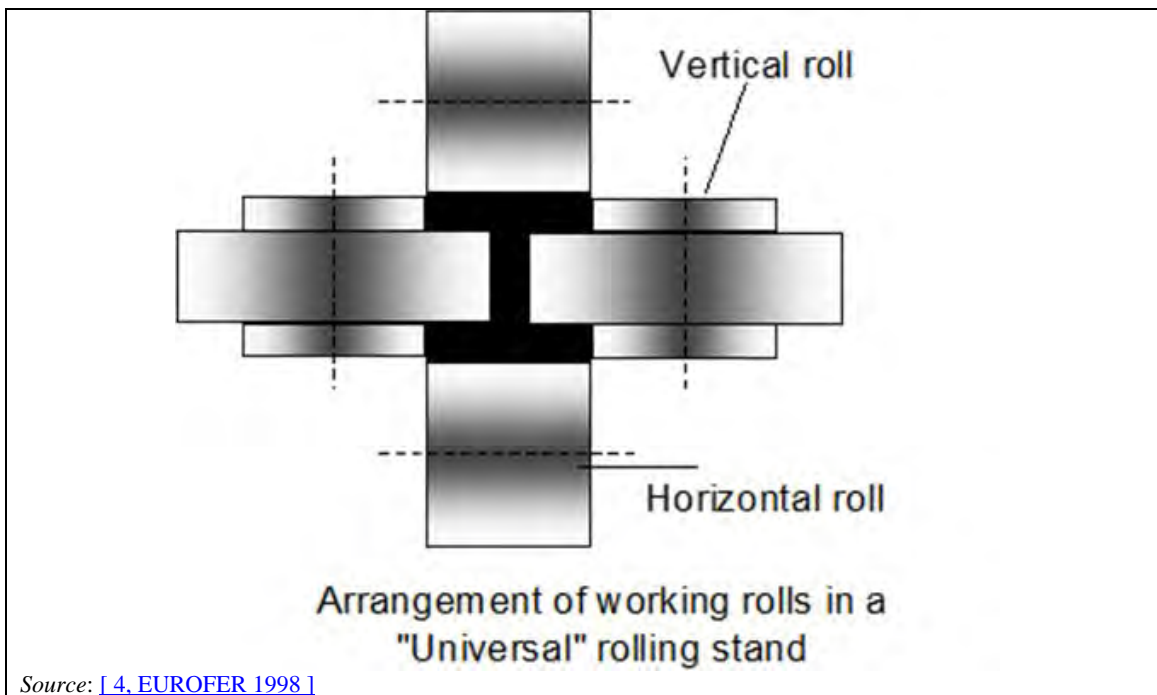


Figure 2.11: Universal stands for parallel flanged product

Geometry control is of the utmost importance in section rolling as relatively tight tolerances are common for hot rolled sections. Measuring devices applying sophisticated techniques including laser beam technology and radioactive sources are commonly used.

The designs of section mills vary greatly according to the manufacturing programme. Figure 2.12 shows the layout of a heavy section mill with universal stands, specialised in parallel flange H and I beams. It includes in-line heat treatment (QST - quenching and self-tempering) to obtain an optimal microstructure for high-strength and high-ductility applications.

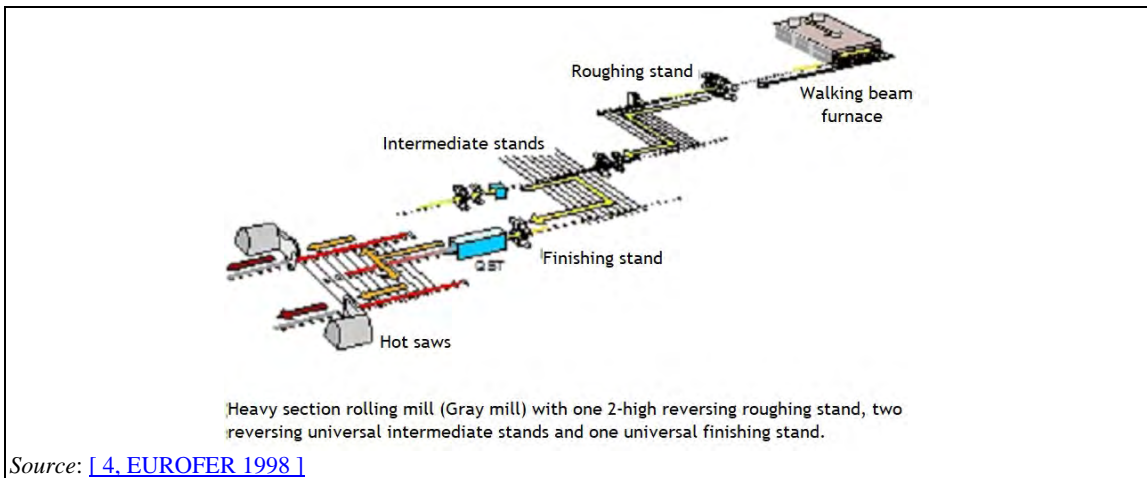


Figure 2.12: Plant layout of a heavy section mill

Figure 2.13 shows the layout of a heavy/medium section mill specialised in the rolling of sheet piling sections. The intermediate stands are of the 'open' type with one common drive. The two-high finishing stand can be replaced by a universal stand for the production of parallel flanged products.

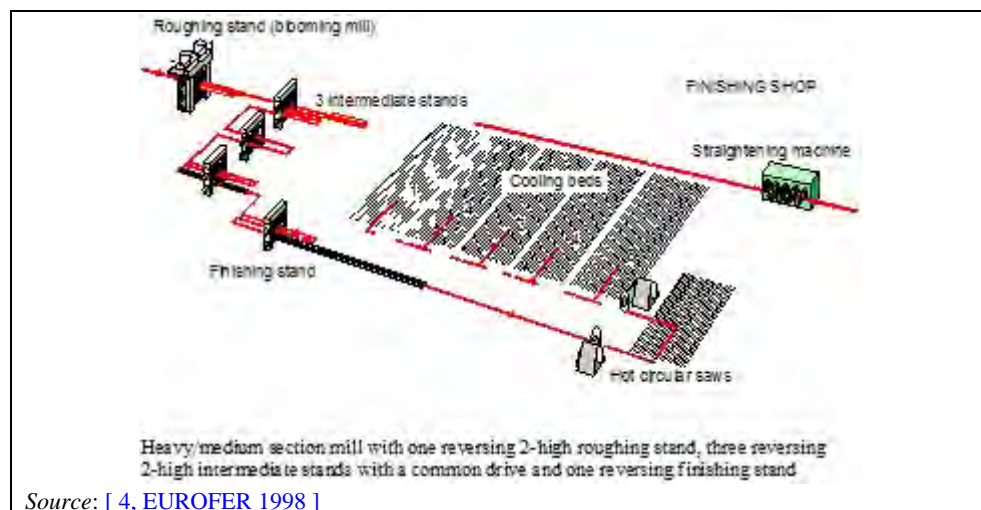


Figure 2.13: Plant layout of a heavy/medium section mill for sheet piling

Section mills increasingly use near-net-shape, continuously cast semis called beam blanks (see Figure 2.14) to increase productivity and decrease energy input.

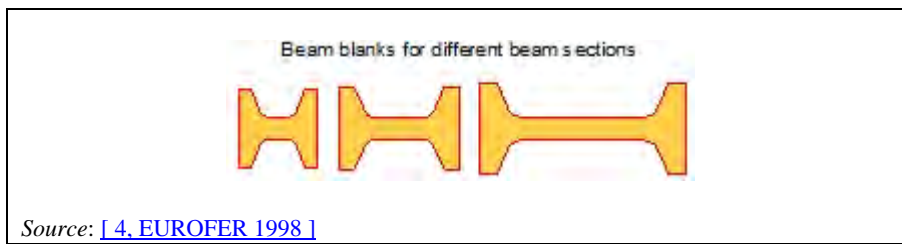


Figure 2.14: Examples of beam blanks' cross sections

If the production rhythm and the manufacturing programme allow, hot charging of continuously cast semis - from the casting machine run-out area to the reheating furnace of the rolling mill - is applied more and more. Considerable savings in energy consumption may be achieved, but this depends on the proximity of the rolling mill to the continuous casting plant.

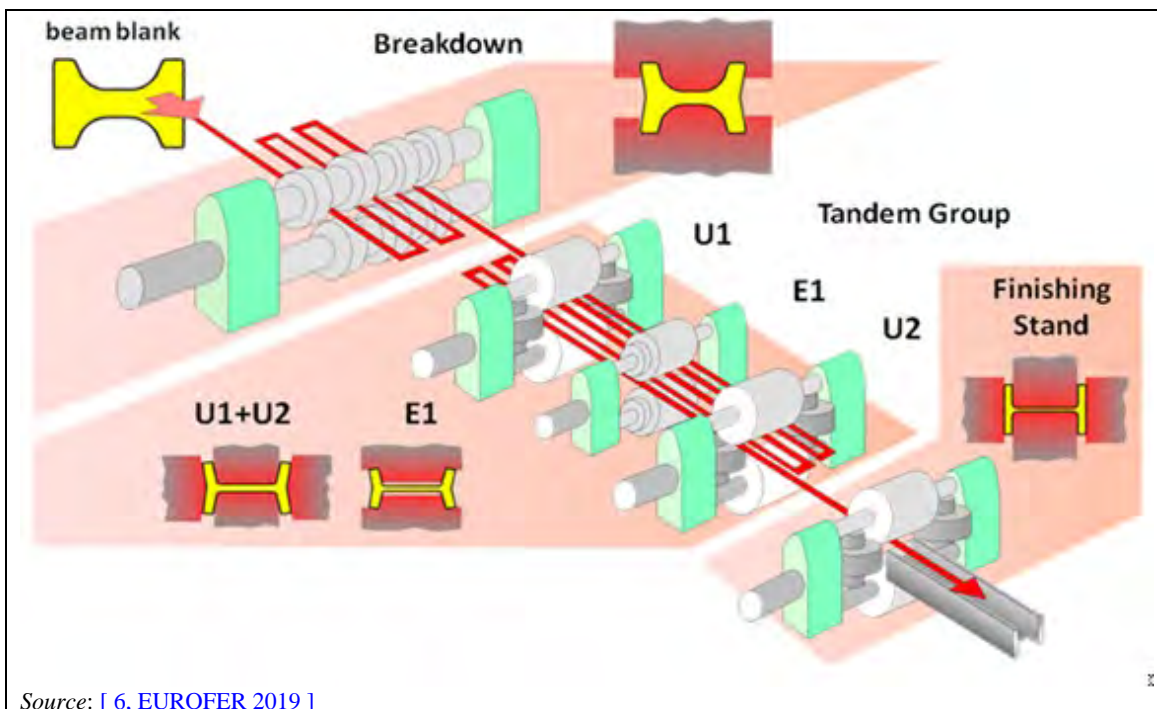


Figure 2.15: Medium section mill fed by cast beam blanks

2.2.1.6 Tube mills

Seamless tube

Seamless tube production basically consists of the following manufacturing steps:

- heating of the input;
- piercing (press-piercing or oblique rolling);
- elongation/stretching;
- final rolling;
- heat treatment.

The most important types of plants used today are mandrel mills, plug mills, push bench mills and pilger mills. Figure 2.16 and Figure 2.17 show some typical tube mill designs.

Raw material for the production of unalloyed and medium-alloy steel tubes are continuously cast round billets or blooms, although sometimes billets with square cross sections are used. The raw material for high-chrome steel tubes are mainly round bars, rolled from cast billets. The input is heated to rolling temperature in rotary hearth furnaces fired with natural gas or oil. Then a hollow billet (ingot) is produced by piercing. The most important hole-piercing process uses inclined rollers. The hole is produced by two inclined rolls rotating in the same direction, so that the ingot is rolled with a screw motion over a piercer plug to form a hollow bloom. The piercer plug is fixed to a freely rotating rod supported by a thrust bearing on the exit side.

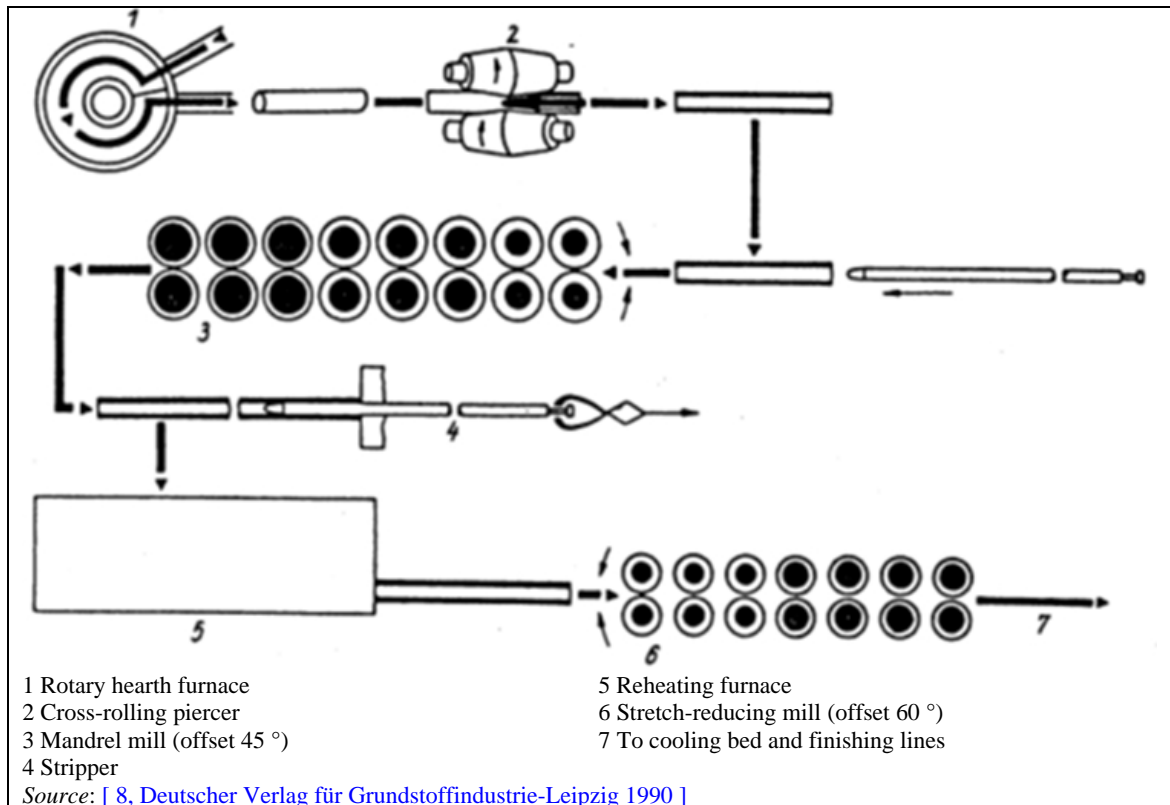


Figure 2.16: Mandrel mill

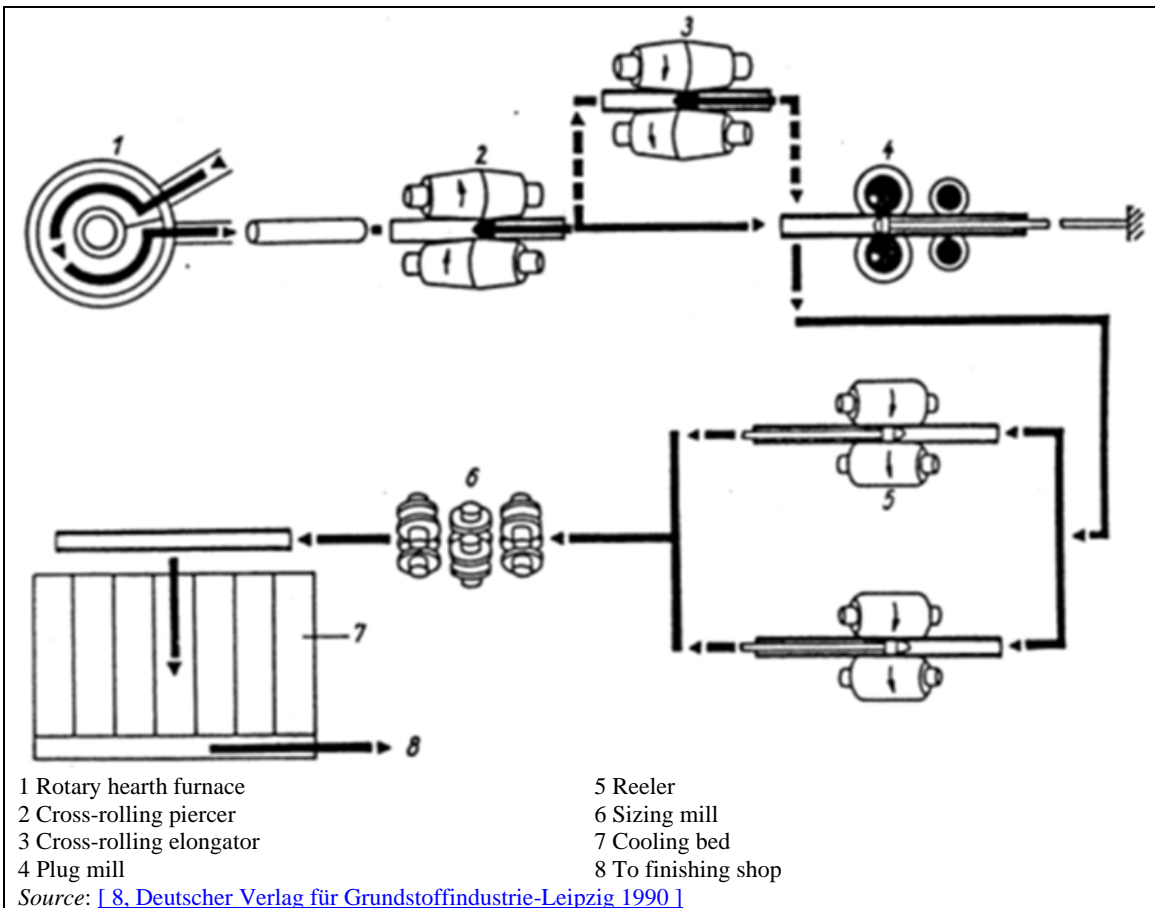


Figure 2.17: Plug mill

Longitudinal rolling, transverse rolling, or presses are used for the elongating stage. The most important one is the continuous tube rolling process, as it is one of the most efficient and productive processes.

Several rolling stands are used simultaneously, usually 6–8 two-high stands per group, at an angle of 90° to each other. The reduction of the wall thickness takes place between the rolls and a cylindrical lubricated mandrel.

Rolling to the finished size is carried out without an inner mandrel in sizing mills or stretch-reducing mills. Sizing mills have 2–10 stands, and can have two or three rolls per stand. As the circumference is reduced, the wall thickness is increased. In stretch-reducing mills, which normally have three rolls per stand, and up to 30 stands, an increase of wall thickness is avoided, as tensile forces are applied between the stands during the process.

Tubes for undemanding applications can be shipped immediately after rolling. For more exacting quality requirements, especially good toughness properties, separate heat treatment is usually carried out after rolling. This can include normalising and tempering.

2.2.2 Surface rectification and conditioning of input

Slabs, blooms and billets can have surface defects, like cracks, folds or seams. Surface preparation of rolling stock may be necessary to ensure the rolled product has flawless surfaces. Surface defects of semi-finished products can also be removed by the following processes.

Scarfig

Scarfig removes surface defects of carbon steel grades by an oxy-fuel flame. The flame is used to rapidly melt and oxidise the steel surface while a separate supply of high-pressure oxygen to the cutter propels the slag product from the surface. Scarfig is either done by hand (for small lot sizes, usually for certain steel qualities) or by machine.

The scale from machine scarfig is washed from the steel surface by high-pressure water and led to a water pit where the scale is removed by crane. The water is treated and recirculated. From manual scarfig operation, scrap collection is carried out by means of magnets.

Dust emissions from scarfig operation are collected and usually abated by electrostatic precipitators (wet or dry).

Grinding

Grinding is another way to remove surface defects of slabs, especially for stainless steels and special steel grades, where thermal removal of the surface defects is not possible. Therefore defects have to be eliminated by grinding. The grinding process is either carried out manually or by machines. Manual grinding is performed by use of handheld power tools, in some cases in booths equipped with fume extraction to bag filter units. Grinding machines are equipped with a roller table on which the workpiece is supported and on which it can be moved. The grinding wheel is mounted on a carriage that permits it to be moved back and forth over the workpiece. The unit is positioned in an enclosure, which collects the dust generated during grinding and ducts it to a bag filter before discharge to atmosphere.

Cutting slabs to size

In some cases, the slabs have to be cut to the appropriate size. Wedge-type slabs, which result from adjustment of the width in the continuous casting plant (mould adjustment) and from change of the lot size, have to be conditioned by torch cutting to obtain the desired geometrical shape.

2.2.3 Reheating and heat treatment furnaces

For hot rolling, the steel input has to be heated to appropriate rolling temperatures between 1 050 °C and 1 300 °C and a uniform temperature distribution has to be ensured.

Depending on the charge material and the hot rolling process, reheating is done in different types of furnaces such as pit furnaces, pusher-type furnaces, walking beam furnaces, rotary hearth furnaces or others. These furnaces are fired directly, usually by oil, natural gas or iron and steel process gases such as COG and BFG. Depending on the heating media, different waste gas emissions will occur (mainly SO₂ and NO_x).

2.2.3.1 Batch furnaces

Batch-type furnaces are often used for speciality steels and forgings. A typical example of the batch-type furnace is **the soaking pit**, used to reheat ingots, slabs and other feedstock. It consists of refractory-lined chambers in which the input is placed vertically (ingots) or horizontally (slabs). A moveable cover allows the input to be charged and removed for rolling. Cast ingots can be charged immediately after stripping to conserve energy. The typical soaking pit capacity is 50–170 tonnes with a thermal input of 9.5 MW (Th) and a heating rate of 10.7 t/h.

Soaking pits are no longer in widespread use as steel is increasingly continuously cast, a process, which often bypasses the soaking pits. An example of the soaking pit furnace is shown in Figure 2.18. [4, EUROFER 1998]

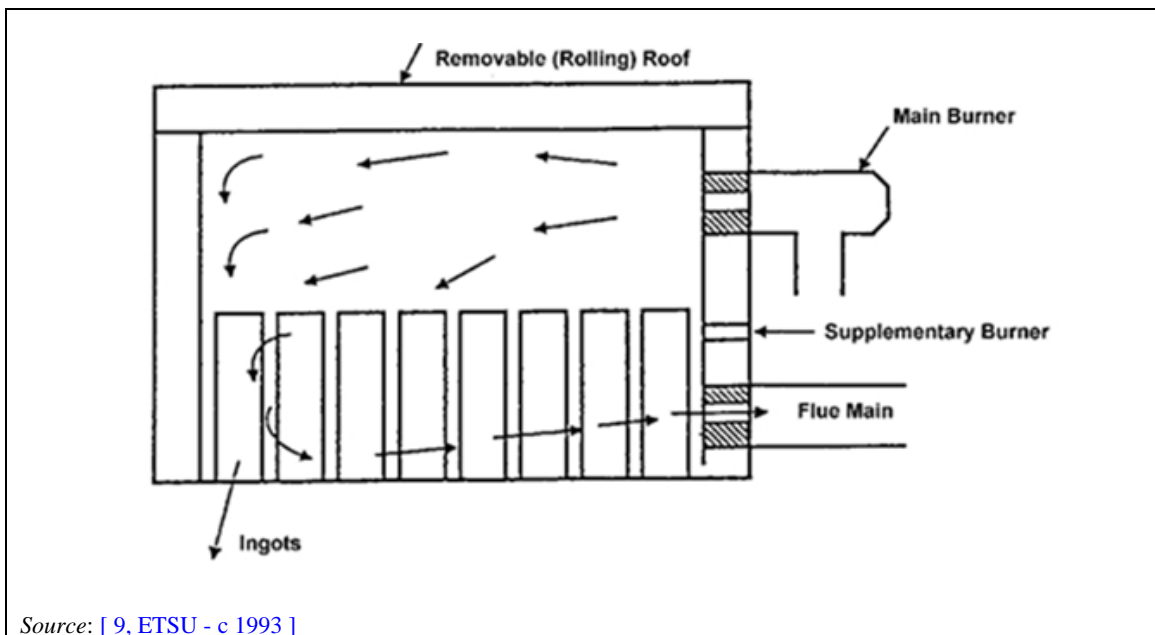


Figure 2.18: Pit furnace

Another type of batch furnace is the bogie hearth furnace. The stock is carried into the furnace chamber on a bogie. The furnace chamber is closed by means of a door and the stock is heated. When the target temperature is reached, the door is opened, the bogie with the stock is removed and the slab or casting is taken away for further use. [4, EUROFER 1998]

2.2.3.2 Continuous furnaces

Larger furnaces are usually fed continuously. The stock is pushed through the furnace by the following stock (**pusher-type furnace**) or is moved through by walking beams (**walking beam furnace**), a walking hearth or on/between rollers.

Examples of the larger size (> 20 MWth) furnaces - the pusher and walking beam furnaces - are shown in Figure 2.19 and Figure 2.20, respectively. The largest currently in operation are walking beam furnaces at Voestalpine Linz of 180 MWth and 420 t/h and pusher furnaces of 200 MWth [4, EUROFER 1998]

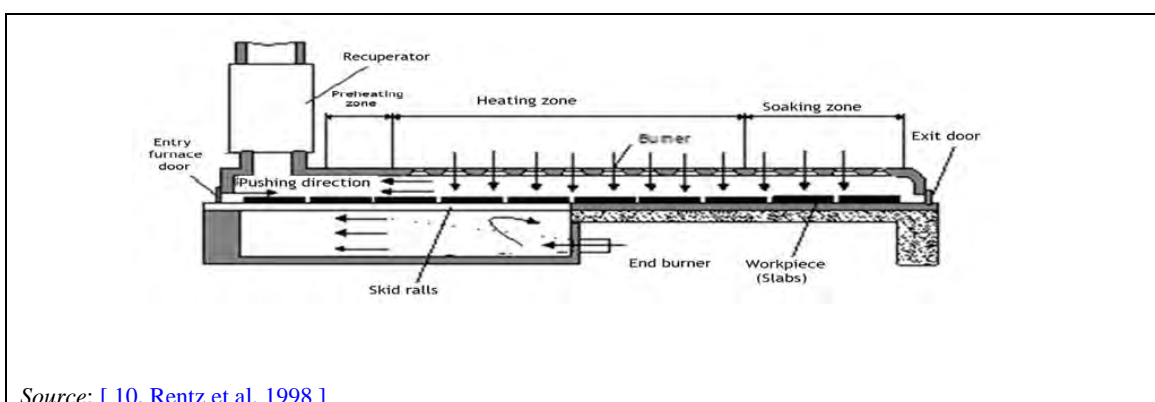
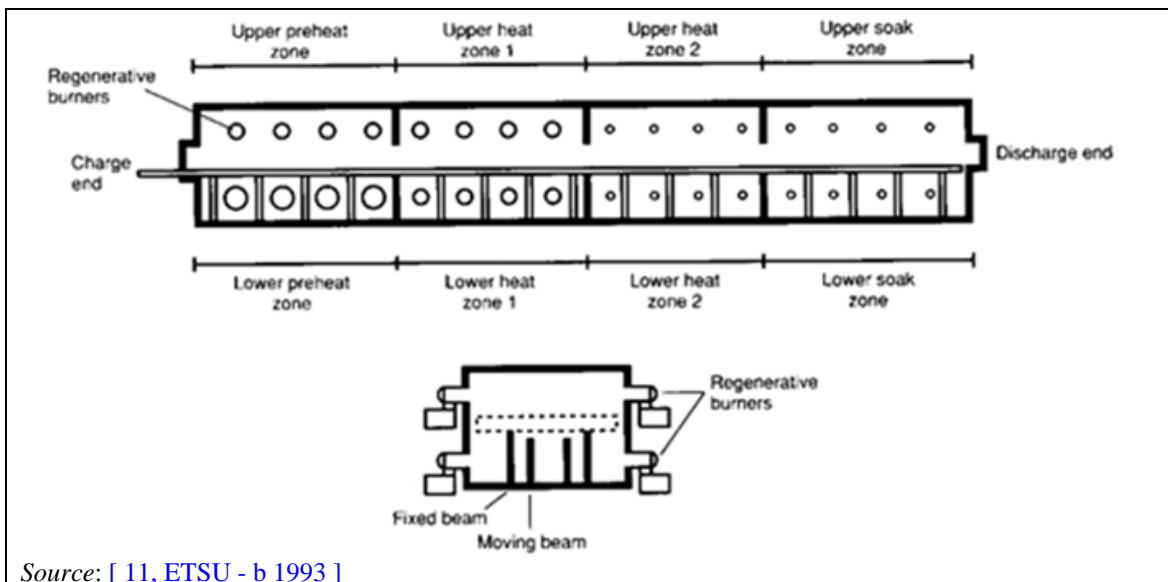


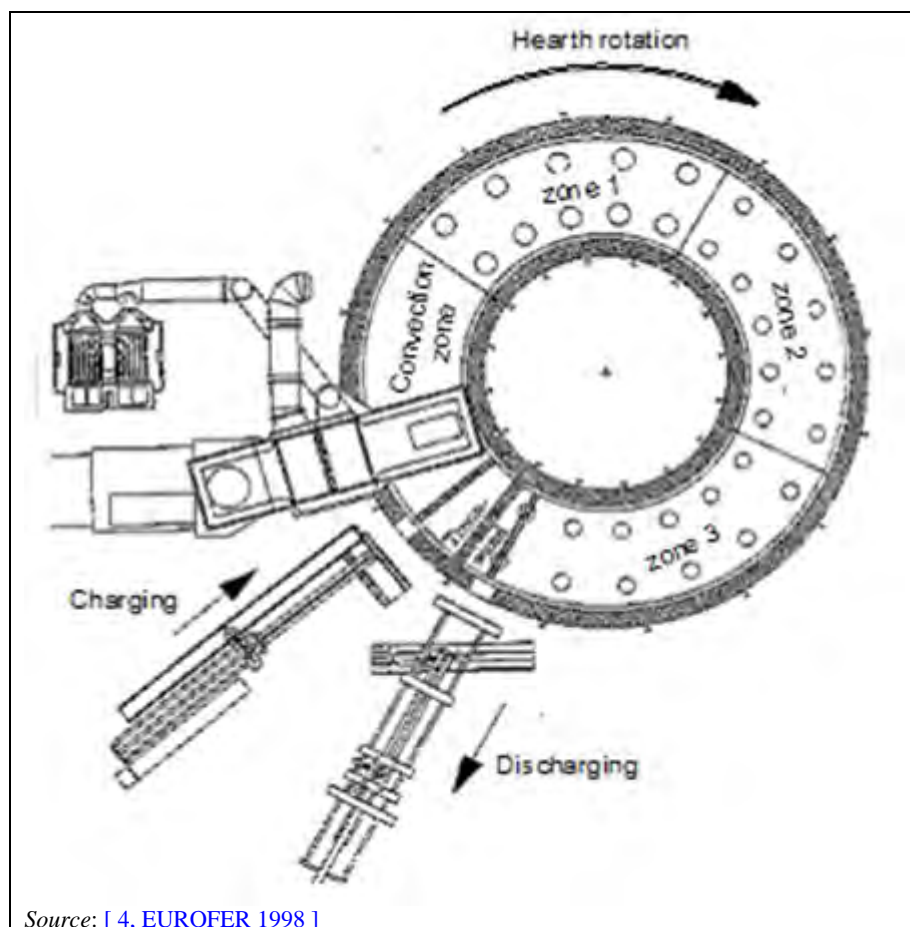
Figure 2.19: Pusher-type furnace



Source: [11, ETSU - b 1993]

Figure 2.20: Walking beam furnace

In a **rotary hearth furnace** (see Figure 2.21), the charge material is placed onto a rotary hearth. During the furnace campaign (hearth is rotating), the material is heated and, after completion of a rotation, discharged.



Source: [4, EUROFER 1998]

Figure 2.21: Typical design of a rotary hearth furnace

2.2.4 Descaling

Prior to rolling, adherent scale, which forms during reheating, must be removed, in order to avoid contamination of the stock surface by scale impressed by the rolls (so-called 'rolled in matter').

Mechanical descaling, where the adherent scale is mechanically broken in a light pass (mostly in two-high stands) and then sprayed off or mechanically removed (brushing), is rarely applied any more. Today, a common method of descaling is breaking and spraying off the scale by means of high-pressure water. Power water with pressures of 120–250 bar (exceptionally 600 bar) is applied via flat jet nozzles onto the material surface. For the cleaning effect, the impact pressure (i.e. the pressure determined by the distance of the descaling nozzles to the rolling stock) is more important than the system pressure. The following techniques are applied throughout the whole rolling process:

- Primary descaling in so-called high-pressure descalers installed before the entry into the roughing train and equipped with one or two pairs of, sometimes adjustable, descaling headers.
- Mill stand descaling by means of descaling headers arranged above and below the plate passage on both sides of the reversing stand and on the entry side in the case of continuous stands.
- Descaling at the entry of the finishing train for removing secondary scale, i.e. the scale formed on the rough strip at the conveying roller table of the roughing train and finishing train.
- Pairs of mill stand descaling sprays at the entry of the first stand of the finishing train. [[4, EUROFER 1998](#)].

In the case of production lines for long products, the descaling headers are either designed as spray rings or as a combination of vertical and horizontal headers, sometimes adjustable to the material cross section, for proper descaling of all material surfaces. [[4, EUROFER 1998](#)]

2.2.5 Edging

Edging is usually applied in the manufacture of strip and plate. The slabs produced in the continuous casting plant are supplied in certain defined stepped dimensions of widths. The width has to be reduced to the specified dimension of the rolled strip, with a trimming allowance as narrow as possible (scrap minimisation and yield improvement). In most cases, this width reduction is performed on so-called edgers (vertical rolling stands) - recently even in slab presses - which are installed before the roughing unit. The accuracy of the width reduction and optimum adherence to the rectangular shape affect the amount of scrap arising from cropping (head and tail end) in the rolling mill and in the finishing shops (trimming).

2.2.6 Roughing

Roughing depicts the first bulk reduction done on the incoming hot rolling stock for the production of strip, rod and sections. Generally, the roughing train consists of one or more horizontal stands for thickness reduction, including edgers (vertical stands) situated before the stand for width adjustment. Reversing roughing mills are sometimes equipped with edgers on both ends of the mill stand. [[4, EUROFER 1998](#)]

2.2.7 Strip rolling / Finishing train

In general, the finishing mill consists of a number of rolling stands positioned after one another. The stands have staggered roll gaps so that the thickness reduction to the requested final thickness is done in one pass of the transfer bar. The number of stands depends on the grade and material thickness of the input (slabs) as well as on the thickness range of the finished strip.

Crop shears arranged in front of the finishing stands serve to cut the ends of the rough strip, which may have the form of a tongue or fishtail. This ensures safe entry into the finishing train and avoids damage to the rolls as well as generation of scrap.

In most cases, an additional descaling device (descaling sprays) as described above is installed between the crop shears and finishing train. Sometimes there is also an additional vertical stand, which is mainly used for strip guidance, but occasionally for minor width adjustments as well.

Coilers

Hot strips with lengths of up to 2 km and more are wound up on so-called down (sometimes up) coilers at the end of the rolling mill at speeds of up to 20 m/s and more. The hot band is guided around an expandable mandrel by specially arranged wrapper rollers. After roughly three to four windings, the wrapper rollers are lifted and the band is coiled onto the expanded mandrel. After the coiling operation is finished, the mandrel is collapsed and the hot coil is transported to a strapping station by means of a coil car. [4, EUROFER 1998]

2.2.8 Rod rolling / Finishing train

The finishing train of rod mills usually consists of rolling blocks with up to 10 sets of alternating horizontal and vertical roller pairs as shown in Figure 2.22.

Rolling speeds of more than 100 m/s are achieved at the final stages. The material used for the roughing and intermediate rolls is generally hardened steel or cast iron while the finishing rolls are made of carbide, a particularly wear-resistant material. The typical calibration used for wire rod mills is a sequence of alternating round and oval calibres.

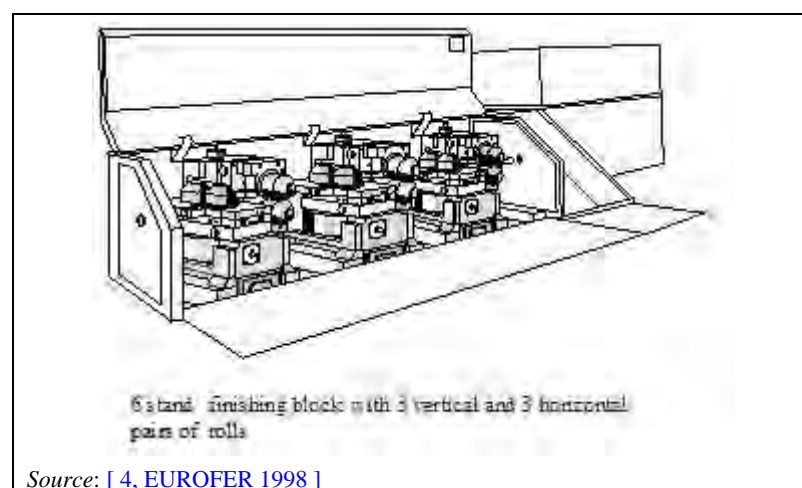


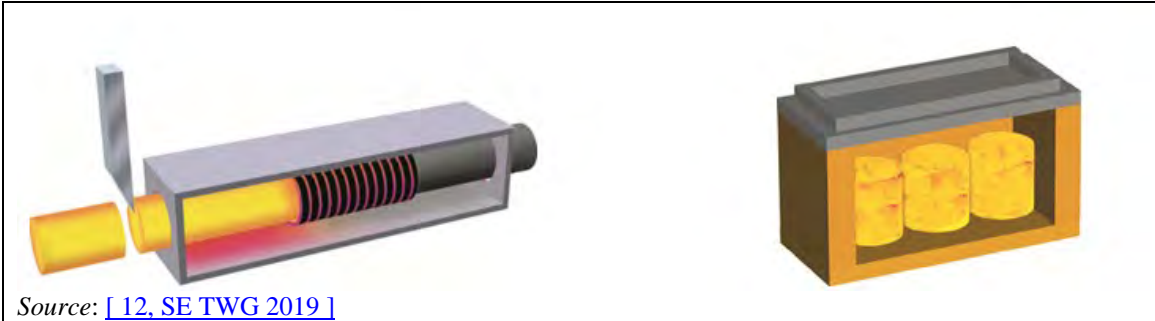
Figure 2.22: Roller arrangement of wire rod finishing section

2.2.9 Plate rolling

Plate rolling by reversing operation is similar to roughing in strip production. The slabs are formed into plates in the so-called multi-stage rolling operations, where the slabs are stretched, turned 90° by means of conical rollers on a special roller table, spread, turned again and rolled to the requested thickness.

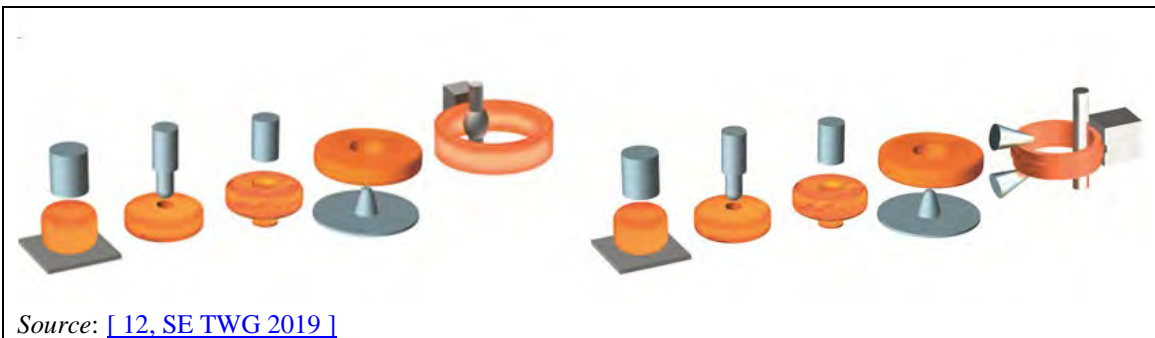
2.2.10 Ring rolling

To produce rings by ring rolling, the first two process steps consists in heating and cutting the billets/ingots into blanks. Heavy ring blanks are cut cold using sawing machines. After heating at around 1 200° C in electrical or LPG-fired furnaces, the blanks are pierced in a press before the material is rolled in rolling mills. The rings produced are normally heat-treated after rolling and some rings are processed in blasting machines to remove mill scale [12, SE TWG 2019].



Source: [12, SE TWG 2019]

Figure 2.23: Material cut into blanks after heating in an induction furnace and blanks heated in a batch furnace after cutting cold



Source: [12, SE TWG 2019]

Figure 2.24: Blanks pierced, pressed and rolled in a radial rolling mill and in an axial rolling mill

2.2.11 Transport of rolling stock between rolling stands

Usually, roller tables arranged along the entire strip rolling train are used as a means of transport for the rolling stock. These roller tables consist of individual metallic hollow and/or solid rollers with single drive or group drive by means of an electromotor and gear, if necessary.

In special cases, for example in a modernised rolling mill including increase of the weight of single products or installation of additional equipment, the distance between the roughing stand and finishing stand is no longer sufficient to decouple the two processes. The so-called coil boxes are then inserted as intermediate storage devices. [4, EUROFER 1998]

2.2.12 Cooling lines

In connection with an appropriate temperature control within the finishing trains, the cooling line provides the material with the desired mechano-technological parameters. The steel is rapidly cooled using either water sprays, water walls or laminar flows (see Figure 2.25).

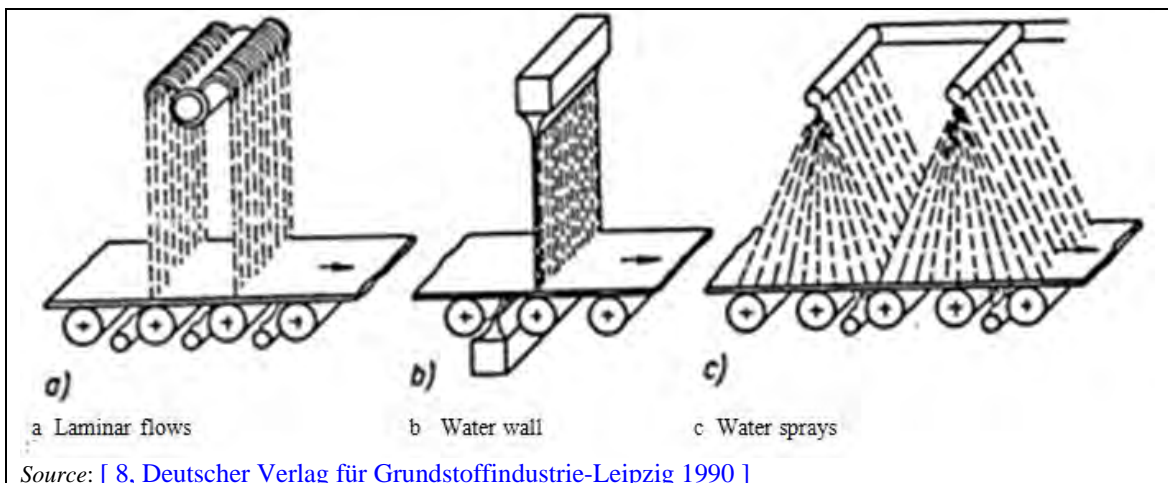


Figure 2.25: Different types of water cooling

Laminar flow cooling on run-out tables is mostly used at the time of writing this document. Usually, the spray headers (arranged on the top and bottom of the passline) are grouped into sections, sometimes of different water flow volumes. Each section and/or each header is individually controllable so that the desired cooling temperature may be realised. Cooling lines and the individual sprays are computer-controlled, whereas the spray headers are switched on and off in accordance with complex mathematical-empirical models, supported by peripheral temperature measurements. [4, EUROFER 1998]

2.2.13 Sheet and plate production

For sheet production, the hot produced coils are decoiled by means of uncoiling reels and supplied to a shearing line which is equipped with levellers to straighten the strip. The rolled sheets with the desired length are piled and stored in the storage yard. [4, EUROFER 1998]

Plate production is carried out on shearing lines following the rolling process. The plates are trimmed on both sides, cropped and cut to the desired length. Cutting to size for special blanks is done by computerised numerical control (CNC)-cutting equipment (torch-, plasma- or laser-beam-cutting units). The internal quality of plates may be determined by ultrasonic techniques. Automatic devices may be installed on the shearing line run-out table.

Finishing operations are computer-controlled in most installations. Consideration is also being given to the in-line quenching and heat treatment of plates following the last rolling pass as a means of conserving energy. [4, EUROFER 1998]

2.2.14 Plate heat treatment

Finished plates are partly subjected to heat treatment. In **annealing**, steel is heated to a subcritical temperature to relieve stresses. For **normalising**, steel is heated above its critical temperature and air-cooled. The purpose is to refine grain sizes and to obtain a carbide distribution, which will dissolve more readily, austenite. **Quenching**, **tempering** and other methods may also be applied.

Several different types of furnaces are used for these purposes, such as walking-beam-type, roller hearth batch or car bottom furnaces. The heating and combustion system of such furnaces are comparable with the systems related to stock reheating. All usually available heating media may be used for firing the treatment furnaces. [4, EUROFER 1998]

2.2.15 Pickling and oiling of hot rolled steel

In many manufacturing applications and processes using hot rolled steel, scale is undesirable. Therefore, hot rolled steel is pickled to remove scale and oiled to reduce corrosion. These processes are carried out in the hot rolling mill to create a product for end users, called hot rolled pickled and oiled steel (HRPO steel).

2.2.16 Roll shop

The workrolls as well as the back-up rolls for both finishing and roughing mills are conditioned according to well-defined specifications, depending on the product to be rolled. Conditioning of the rolls is performed at the roll shop where typical machine shop techniques are applied, such as machining and grinding. [4, EUROFER 1998]

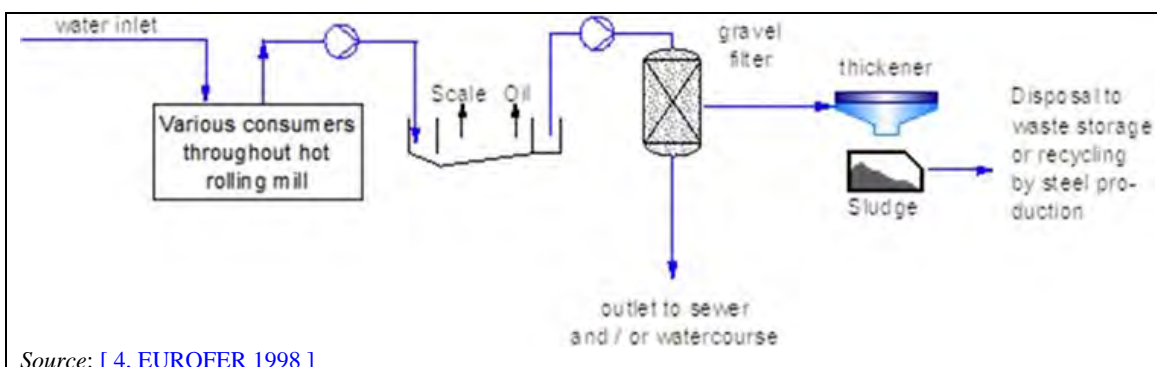
A roll shop generally includes the following:

- Cooling area where work rolls are cooled either in the open air or by water sprinkling.
- Preparation area where the rolls are dismantled and set up. (In some cases, the roll shop machines allow reconditioning of rolls without prior dismantling.)
- Cleaning area where the rolls to be reconditioned are cleaned of deposits and lubricants. (The cleaning techniques include steam cleaning, application of alkali degreasing solutions, application of organic solvents.)
- Typical machine shop equipment including lathes and grinding machines which have an individual cooling system where the cooling liquid is continuously processed in order to separate turnings and grinding sludge. [4, EUROFER 1998]

2.2.17 Water circuits / Water management in hot rolling mills

Throughout the hot rolling process and linked process steps, water is used for cooling and for technological reasons. Electric motors, reheating furnaces, control rooms and power systems, instruments and process control systems are usually cooled indirectly. The steel, rolls, saws, cropped ends, coilers and hot run-out tables are cooled directly. Water is also used for scale breaking, flushing scale and for scale transport. Wherever the water is in contact with the rolled material (process water) and rolling equipment it will be contaminated with scale and oil.

The simplest water feeding system applied is an **open system** (once-through system) as shown in Figure 2.26. The water is taken from natural resources (river, lake or groundwater), flows through the various consumers of the hot mill and is released again to the watercourse.



Source: [4, EUROFER 1998]

Figure 2.26: Example of a once-through water system

The polluted cooling and process waters are collected and treated prior to discharge. The first treatment stage is a sedimentation basin in which solids, mainly iron oxides, are allowed to settle at the bottom of the basin.

The sedimented solids are discharged via appropriate devices (scraper, screw, etc.) and, in the case of integrated steel plants, returned to the production process via the hot metal route. The oil pollutants floating on the surface are removed by means of suitable skimming devices and are discharged to the respective collecting basins.

The precleaned overflow is supplied via pipes to the filter batteries whose number, size and capacity are designed in conformity with the water volume. In most cases, these filters are gravel filters, i.e. the overflowing water is cleaned by passing through gravel beds.

The pollutants in the gravel filters must be removed by back-washing in order to maintain the function and separation efficiency of the filters. The purified waste water from the filters is discharged into the sewage system and/or lakes and rivers.

The sludge-bearing waters (mostly containing iron oxide) from the filter batteries are separated in a thickener. The overflow is recirculated to the cleaning circuit system. The high-quality feed material contained in the sludge is further dewatered and disposed of or returned to the steel production process, provided the appropriate technical equipment is available.

In order to reduce or avoid waste water discharge from hot rolling operations, semi-closed and closed circuits are implemented.

In **semi-closed circuits**, as shown in Figure 2.27, the water is treated and partly reused depending on the temperature. The water treatment devices are the same as for open systems, but the filtered waste water is not directly disposed of. Instead, it is conveyed into a filter water basin and mixed with cold fresh water, if necessary. Depending on the temperature of the mixed water, the filtered water is returned to the different consumers in the hot rolling mill and only the overflow is discharged. Accordingly, the volume of the circulating water depends on the season and the geographical location.

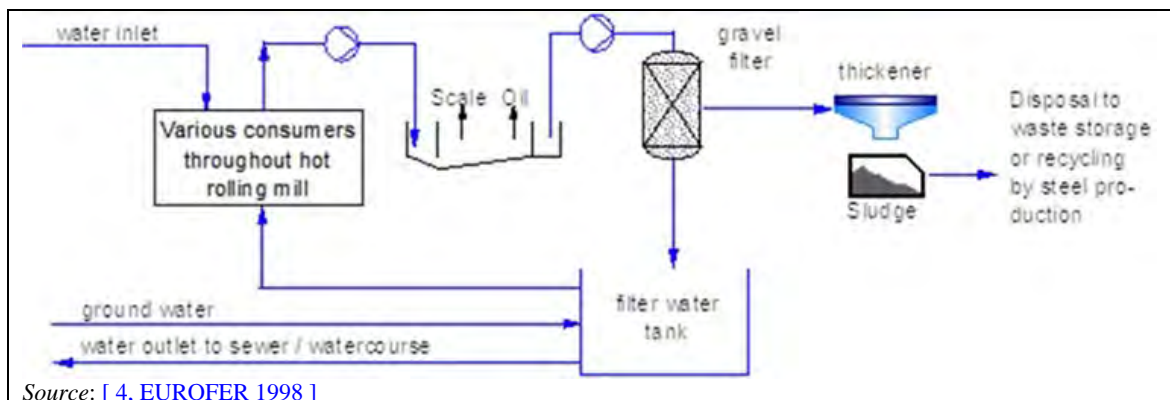
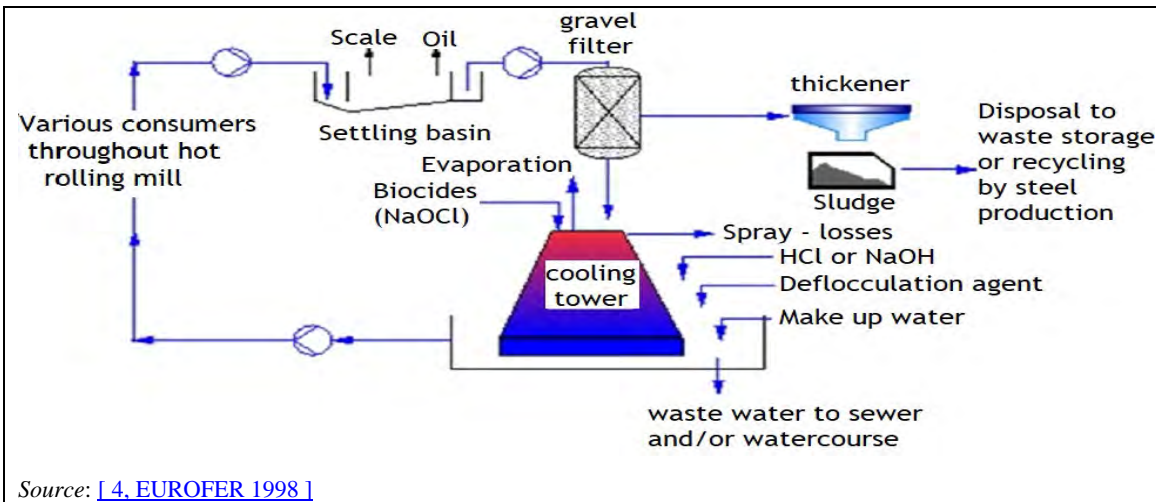


Figure 2.27: Example of a semi-closed water circuit

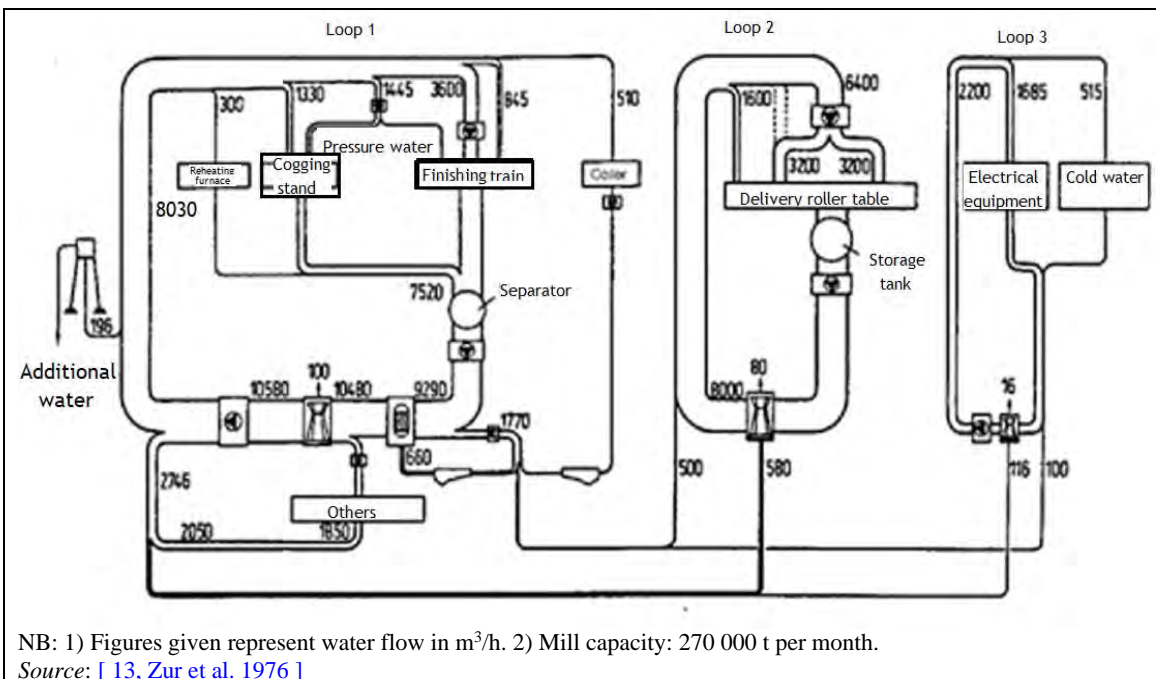
In **closed water circuits** (see Figure 2.28), the purified water is not discharged, but recooled in cooling towers or heat exchangers to the required temperature and reused in the rolling process. For plants using cooling towers, water consumption is restricted to the additional water (approximately 3–5 %) needed to make up for evaporation and for blowdown losses. When heat exchangers are used, large recirculating volumes of recooling water are required.



Source: [4. EUROFER 1998]

Figure 2.28: Example of a closed water circuit

Water feeding and treatment systems in hot rolling mills are usually very complex, with several partly interconnected water loops and multiple-stage use of water. In some cases, the hot rolling mill water circuit is coupled with the water feeding systems of other iron and steel production units, like for example continuous casting. The reasons for this connection are the similarity of the waste water contents and the proximity of the installations.



NB: 1) Figures given represent water flow in m³/h. 2) Mill capacity: 270 000 t per month.

Source: [13. Zur et al. 1976]

Figure 2.29: Water loops for hot strip rolling mill

Figure 2.29 shows the water circuit of a hot wide strip mill where three water loops are established. Loop 1 (8 030 m³/h) comprises the cogging stand, finishing train and reheating furnace; loop 2 (8 000 m³/h) the delivery roller table and loop 3 (2 200 m³/h) mainly the electrical equipment. The loops are connected in a way that the water input for loops 2 and 3 is supplied by the clean water side of loop 1. The process water of loops 2 and 3 is sent to the treatment facilities of loop 1 and blowdown water can also be discharged to loop 1.

Figure 2.30 shows another example of a water management system for a hot wide strip mill. The loops established in this case are for furnace and engine cooling, for roller stands and for laminar strip and roller table cooling.

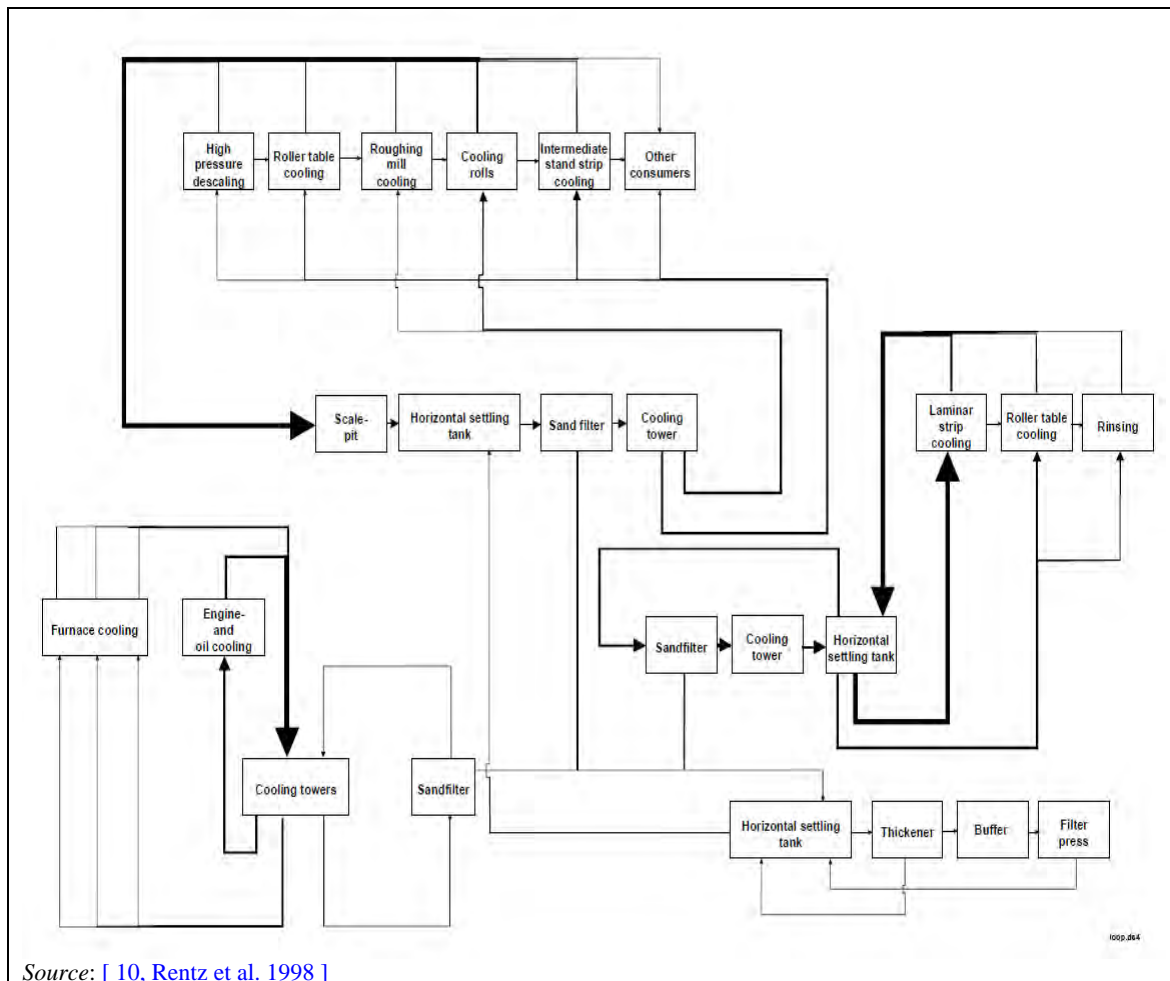


Figure 2.30: Use of water loops in a hot rolling mill

The prevention of effluents by using water in loops or in multiple stages is a well-known and widespread practice within the steel industry. Hot rolling mills offer a high potential for reduction in water consumption and waste water discharge, because of the large quantities of water needed.

2.2.18 Waste and by-product management in hot rolling mills

Apart from waste water, hot rolling operations generate different kinds of solid and liquid by-products and waste:

- metallic waste and by-products;
- scarfing scale/swarf;
- dusts from scarfing and rolling;
- mill scale (oil-free and oily);
- water treatment and mill scale sludge;
- grinding sludge (roll shop);
- oil and greases.

Metallic by-products/waste, like scrap, downgrades, crop ends, etc. arising from hot rolling, is usually relatively clean and is easily recycled into metallurgical processes (e.g. BOF).

Oil-free **scale** and low-oil-content (< 1 %) scale is fed directly back into the metallurgical process, usually via the sinter plant. Oily, ferrous sludges with up to 80 % FeO_n content, like **oily mill scale** and **grinding sludges**, obtained from water treatment plants have to be conditioned before internal recycling.

Scale is also sold for external use (e.g. to cement manufacturers) or it is supplied to an external company for treatment (usually thermal treatment to burn the oil content). Thermal treatment plants can yield a product with an iron content of about 60–70 %. If the thermal treatment plant is fed with oily mill scale of about 4.5 %, no additional energy supply is required.

Oxide dusts from air cleaning devices, for example from bag filters for oxide removal at the mill stands, are recyclable to the steel production (e.g. sinter plant) without risks.

Oil and grease, separated and collected at various stages, are energy sources and can be utilised as secondary fuels, for example by injection into the blast furnace or in the coke-making process. Dewatering might be a precondition. Alternatively, these materials can be used at the coke ovens to increase coal bulk density prior to carbonisation. [[4, EUROFER 1998](#)], [[14, Hot Rolling Shadow Group 2000](#)]

Spent emulsion from the roll shop or other consumers can be split into components: oil and water. The separated oil can be thermally utilised or recycled externally. [[14, Hot Rolling Shadow Group 2000](#)]

2.3 Current consumption and emission levels for hot rolling mills

The following sections present the consumption and emission data reported by the HR plants across the EU that took part in the 2018 FMP data collection (in total 125 plants). The relevant plants are listed in Section 11.1 in which a List of installations/plants that participated in the 2018 data collection for the FMP BREF review may be found.

Handling of Confidential Business Information (CBI)

Energy, material and water consumption data were considered CBI by the plant operators. In order to maintain data confidentiality, plant names are not directly mentioned in the graphs but are replaced by anonymised and randomly attributed CBI codes. In addition, no contextual information (e.g. process parameters or techniques applied) is included as this could reveal the identity of the plants. Only the steel category and the steel products is indicated in the figures provided that more than 5 distinct consumption values were reported in the data collection. If less than 5 distinct consumption values were reported, the data are shown under a category designated as 'other' without any indication in the figure of the steel category or the steel product to maintain confidentiality. All the consumption figures are presented in ascending order of the maximum specific energy consumption values.

2.3.1 Mass stream overview

Figure 2.31 provides an overview of the various inputs (e.g. types of steel products, energy, water, oil) and outputs (e.g. hot rolled product, air and water emission, by-products and waste) in a typical hot rolling mill.

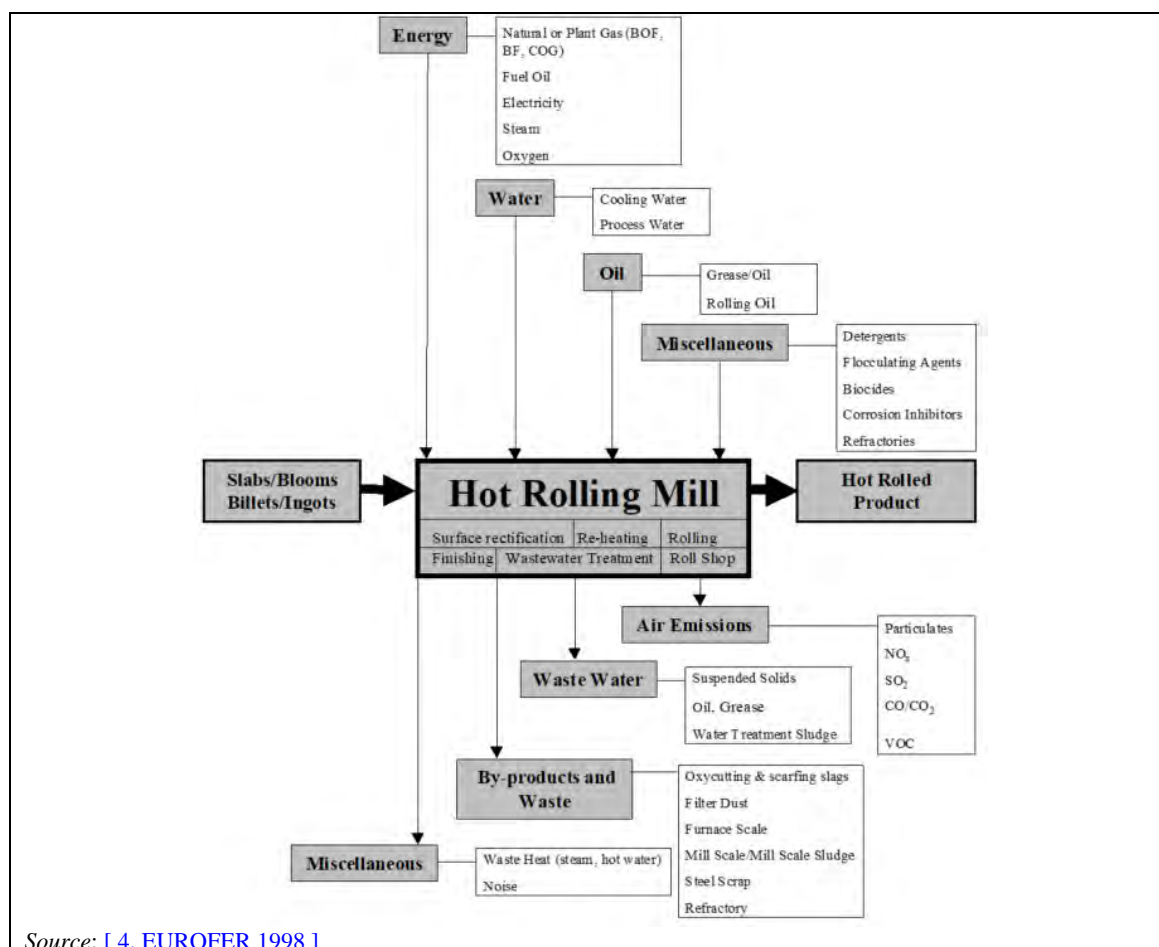


Figure 2.31: Input/output overview for hot rolling mills

2.3.2 Energy consumption

Energy consumption

Integrated steel plants try to valorise as much as possible the gases arising within the works for internal use. Hence blast furnace gas, coke oven gas, BOF gas, natural gas and many different combinations of these gases (so-called mixed gases) are used in continuous furnaces.

The energy consumption of the furnaces depends on several parameters such as:

- the furnace design (pusher-type, walking beam, etc.);
- throughput and shift patterns (operating time); [[15, UK, TWG member 1999](#)]
- the designed length of the recuperation zone in the furnace;
- the burner design;
- the use of recuperators or of a regenerating system;
- the production capacity of the furnace;
- the heating zone arrangement;
- the charging temperature of the stock;
- the heating and discharging temperature;
- the accuracy of the thermal regulation;
- the degree of insulation of the furnace; [[4, EUROFER 1998](#)]
- the operation point in relation to the design point;
- the O₂ content in the atmosphere. [[6, EUROFER 2019](#)]

During the data collection, data on the specific energy consumption of plants (i.e. MJ of energy consumed per total amount of feedstock processed expressed in t/year) were reported for the following processes:

- feedstock reheating, intermediate heating and post-heating;
- hot rolling for rolling processes, including roughing and finishing.

Figure 2.32, Figure 2.33 and Figure 2.34, show the data reported on specific energy consumption (yearly average) for feedstock reheating, intermediate heating and post-heating, respectively. Figure 2.35 shows the data reported on the specific energy consumption in hot rolling for rolling processes, including roughing and finishing. These figures present the yearly specific energy consumption values for each line of the plants. For the figures related to specific energy consumption for feedstock heating, the values reported correspond to the average specific energy consumption values for all the furnaces for each line.

Feedstock reheating

Table 2.6 summarises the ranges observed for the specific energy consumption (yearly average) of feedstock reheating, depending on the steel category, steel product and steel grade. In total, 97 plants provided data on specific energy consumption. The large majority of specific energy consumption data ranges from 590 MJ/t to approximately 5 400 MJ/t. Only two plants reported extremely high specific energy consumption values which can be considered as outlier values (See Figure 2.32).

Table 2.6: Specific energy consumption ranges for feedstock reheating

Steel category <i>Steel products</i>	Steel grade	Specific energy consumption MJ/t (Yearly average)
Flat		
<i>Hot rolled coils (Strips)</i>	Carbon steel	1 100–1 800
	High alloy steel	1 900–2 750
<i>Heavy plates</i>	Carbon steel	1 190–2 300
	High alloy steel	2 000–2 870
Long		
<i>Bars, rods</i>	Carbon steel	590–2 300
	High alloy steel	1 100–5 400
<i>Beams, billets, rails, tubes</i>	Carbon steel	1 350–2 650
<i>Others</i>	Carbon steel	1 500–6 000
Source: [16, FMP TWG 2018]		

Feedstock intermediate reheating

Only 8 plants submitted data on the specific energy consumption from intermediate feedstock heating. All the data reported were related to the production of long products and were within the range 76 MJ/t to 870 MJ/t.

Feedstock post-heating

Table 2.7 summarises the ranges observed for the specific energy consumption of feedstock post-heating depending on the steel category, steel product and steel grade. For feedstock post-heating, in total, 29 plants provided data with specific energy consumptions ranging from 290 MJ/t to 7 500 MJ/t.

Table 2.7: Specific energy consumption ranges for feedstock post-heating

Steel category <i>Steel products</i>	Steel grade	Specific energy consumption MJ/t (Yearly average)
Flat		
<i>Heavy plates</i>	Carbon steel	1 000–2 000
	High alloy steel	1 500–4 400
Long		
<i>Bars, rods</i>	Carbon steel	900 –5 300
	High alloy steel	1 150–3 600
<i>Others</i>	Carbon steel	290–7 500
Source: [16, FMP TWG 2018]		

Hot rolling including roughing and finishing

The energy demand for the motor-driven rolls in hot rolling depends on the degree of deformation, temperature of the workpiece and material hardness. Energy is used in form of electricity. In total, 78 plants provided data for specific energy consumption of rolling processes, with specific energy consumptions ranging from 70 MJ/t to 1 300 MJ/t. Table 2.8 summarises the ranges for the reported specific energy consumption values in hot rolling, depending on the average thickness and cross section reduction, the steel category, steel product and steel grade.

Table 2.8: Specific energy consumption ranges for hot rolling including roughing and finishing

Steel category <i>Steel products</i>	Steel grade	Average thickness/Cross section reduction %	Specific energy consumption MJ/t (Yearly average)
Flat			
<i>Hot rolled coils (Strips), Heavy plates</i>	Carbon steel	90-99	70–300
	High alloy steel	95-98	262–430
Long			
<i>Bars, rods</i>	Carbon steel	60-99	110–540
	High alloy steel	99-100	750–1 060
<i>Beams, billets, rails, tubes</i>	Carbon steel	70-99	80–1 300
Source: [16, FMP TWG 2018]			

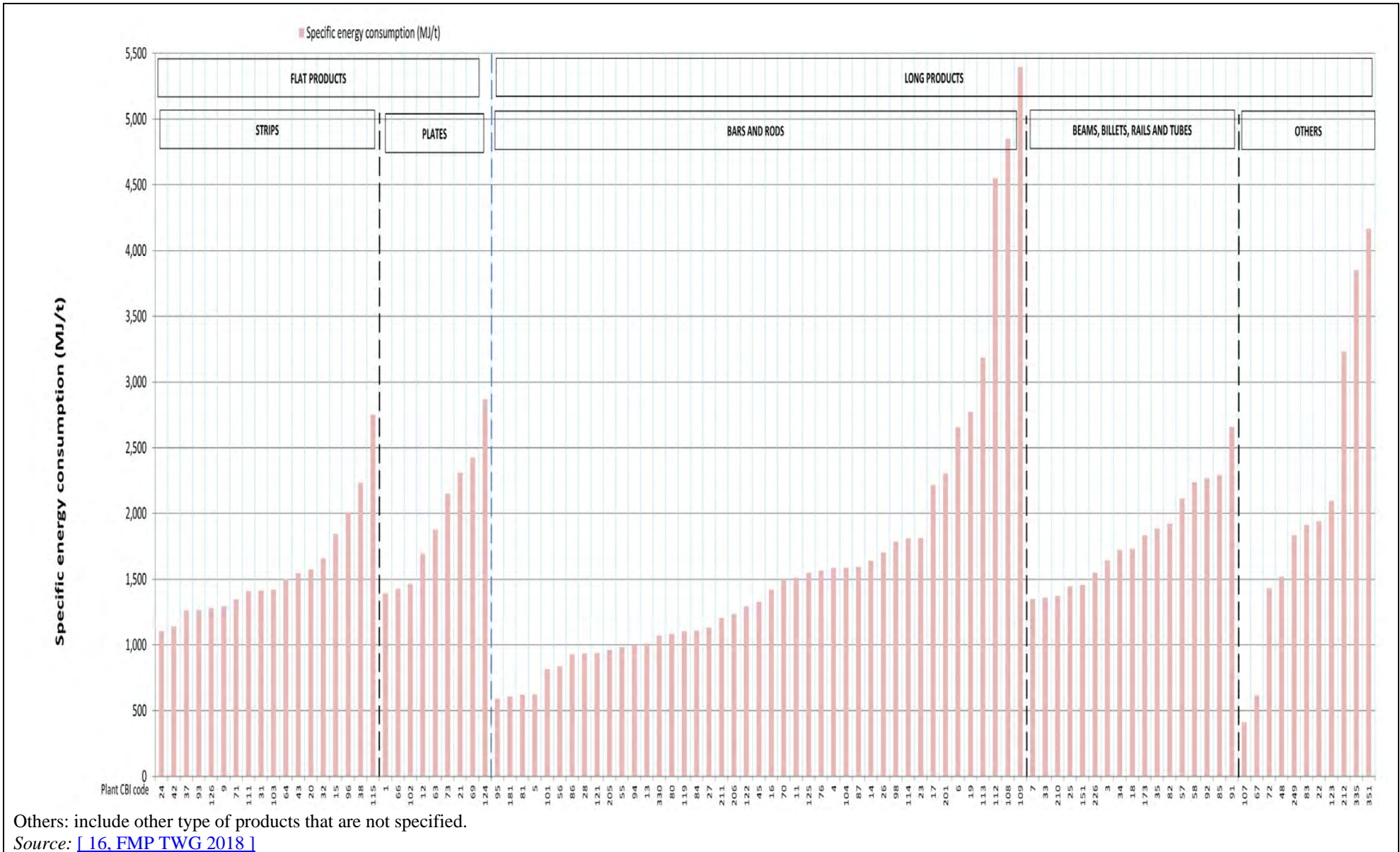


Figure 2.32: Specific energy consumption (MJ/t of feedstock processed) for feedstock reheating

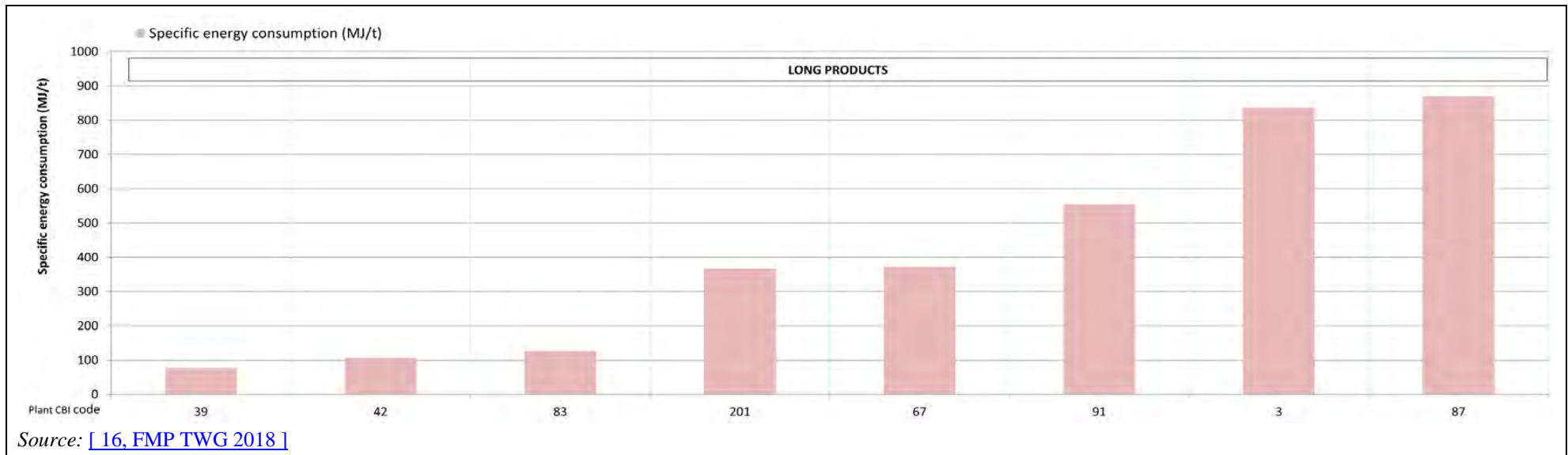


Figure 2.33: Specific energy consumption (MJ/t of feedstock processed) for feedstock intermediate heating

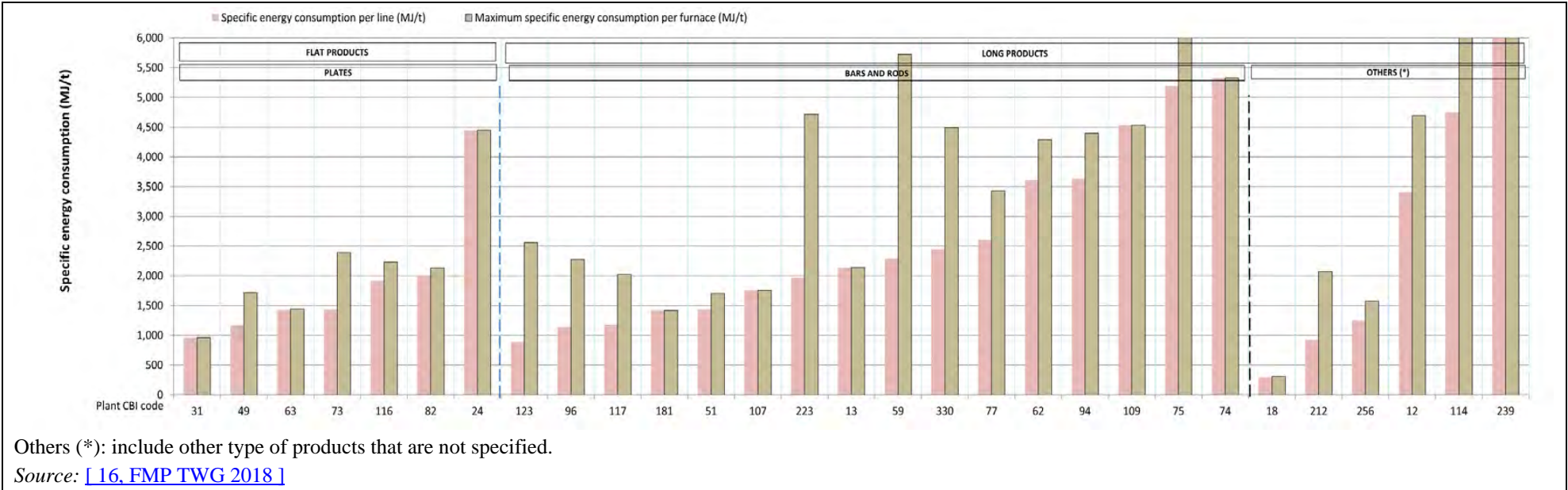


Figure 2.34: Specific energy consumption (MJ/t of feedstock processed) for feedstock post-heating

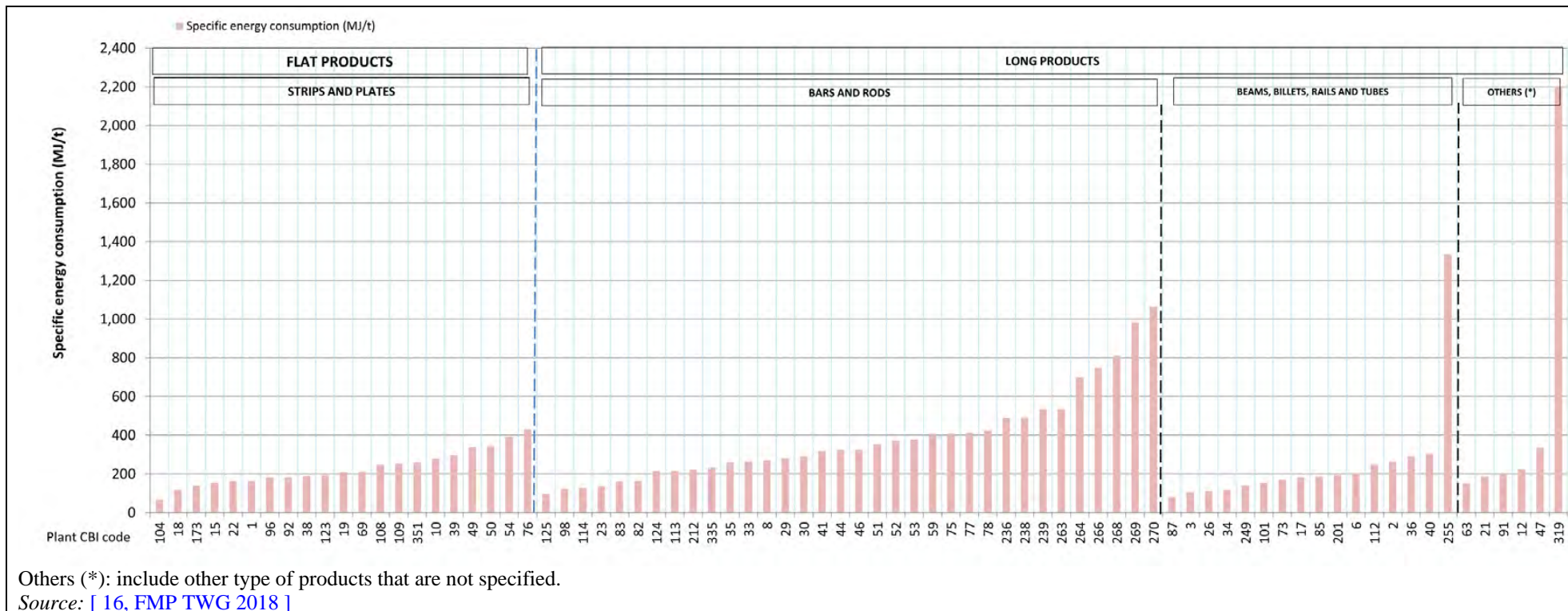


Figure 2.35: Specific energy consumption (MJ/t of feedstock processed) for rolling processes

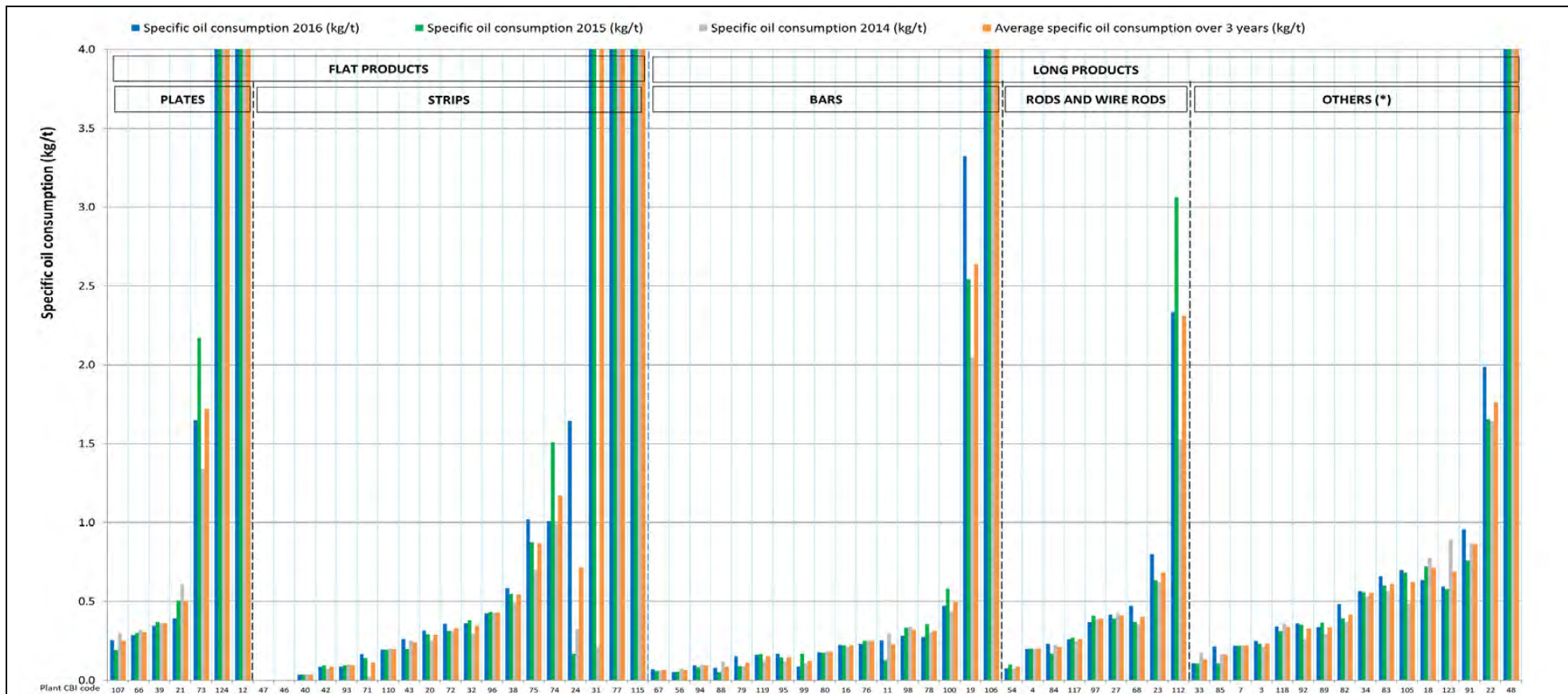
2.3.3 Material consumption

2.3.3.1 Consumption of oils

Values of oil consumption include all types of oils used in the plant (e.g. rolling oil, hydraulic systems oil, lubrication oil, anti-corrosive oil, fat and grease). Table 2.9 shows the reported data of specific oil consumption for three years (2014 to 2016), and the yearly average obtained, for hot rolling plants. A summary of the oil consumption ranges observed for each product type is summarised in Table 2.9.

Table 2.9: Specific oil consumption ranges for hot rolling

Steel category <i>Steel products</i>	Steel grade	Specific oil consumption kg/t (Yearly average)
Flat		
<i>Hot rolled coils (Strips)</i>	Carbon steel	0.04–0.7
	High alloy steel	0.4–600
<i>Heavy plates</i>	Carbon steel	0.3–180
	High alloy steel	0.3–160
Long		
<i>Bars, rods</i>	Carbon steel	0.06–0.6
	High alloy steel	0.2–635
<i>Beams, rails, tubes</i>	Carbon steel	0.2–1.7
<i>Others</i>	Carbon steel	0.6–89
<i>Source: [16, FMP TWG 2018.]</i>		



Others (*): include other type of products that are not specified.

Values too high or too low for the scale of the figure:

Sorting number	Specific oil consumption 2016 (kg/t)	Specific oil consumption 2015 (kg/t)	Specific oil consumption 2014 (kg/t)
12	223.5	159.5	171.1
31	13.3	8.2	0.2
77	643.6	665.4	575.7
115	1 981.5	2 204.1	1 717.3
106	716.0	820.0	370.0
48	86.2	91.2	88.6

Source: [16, FMP TWG 2018]

Figure 2.36: Specific oil consumption (kg/t of production) in hot rolling plants

2.3.3.2 Consumption of acids

Figure 2.37 to Figure 2.39 show data on the specific acid consumption for three operating years, and the yearly average obtained, for hot rolling plants from the FMP data collection, at line level, producing HRPO steel. Each figure corresponds to a different type of acid, namely hydrochloric, sulphuric, nitric and hydrofluoric acid. The specific acid consumption is expressed in kg of acid per m² of treated (pickled) surface. The concentrations of acids considered were 33 %-wt, 96 %-wt, 49 %-wt and 70 %-wt., for HCl, H₂SO₄, HNO₃ and HF, respectively. In total, 6 production lines reported information for HCl and H₂SO₄, while 5 production lines reported information for mixed acids (HF and HNO₃). Table 2.10 summarises the acid consumption ranges reported by these HRPO plants.

Table 2.10: Specific acid consumption ranges for HRPO plants

Type of acid	Average specific surface of input (m ² /t)	Specific acid consumption (kg/m ² of treated surface) (Yearly average)
HCl	4-95	0.002-0.9
H ₂ SO ₄	15-95	0.03-0.4
Mixed acids (HF-HNO ₃)	15-95	0.2-0.3
<i>Source: [16, FMP TWG 2018]</i>		

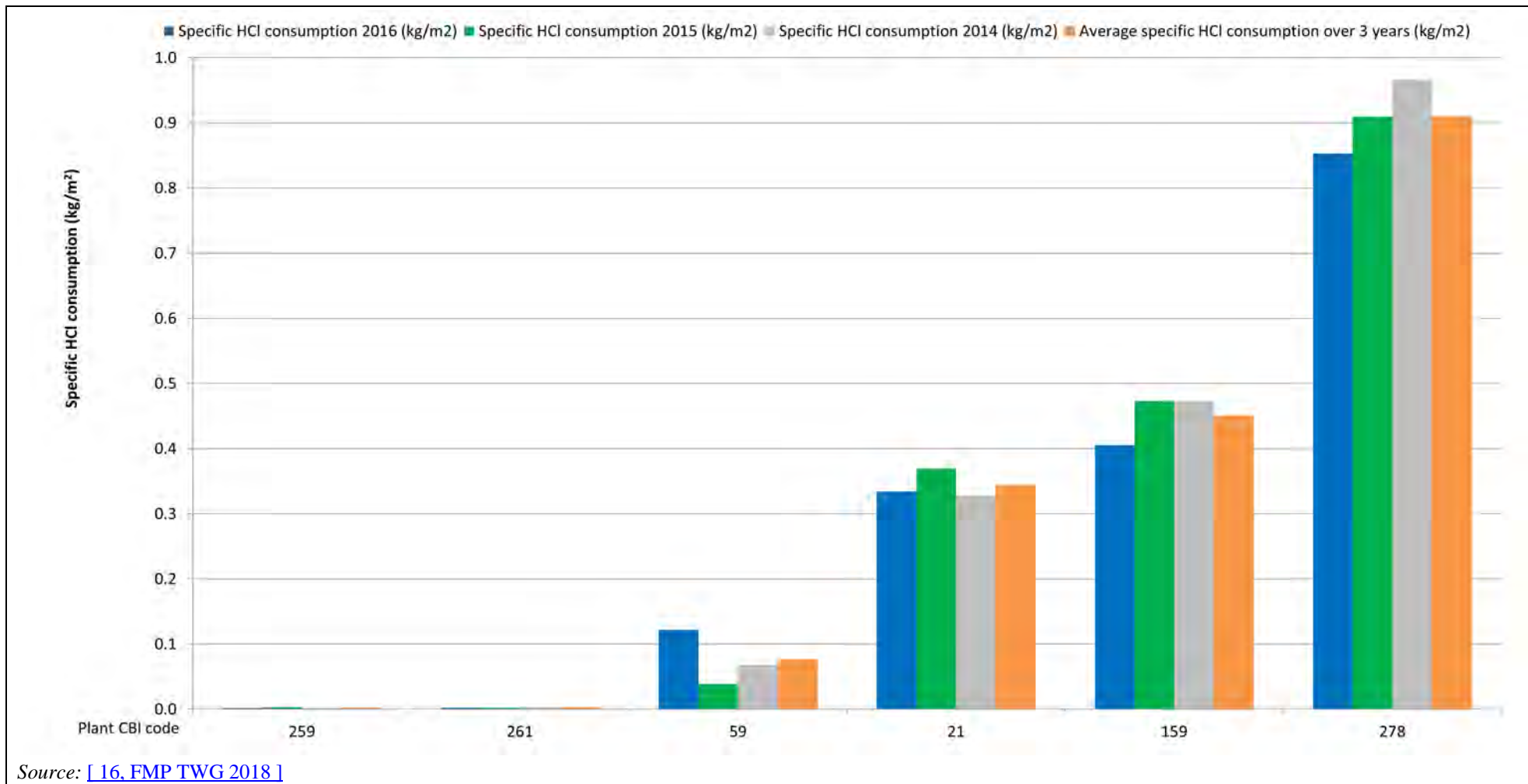


Figure 2.37: Specific HCl consumption (kg/m² of treated surface) in HRPO plants

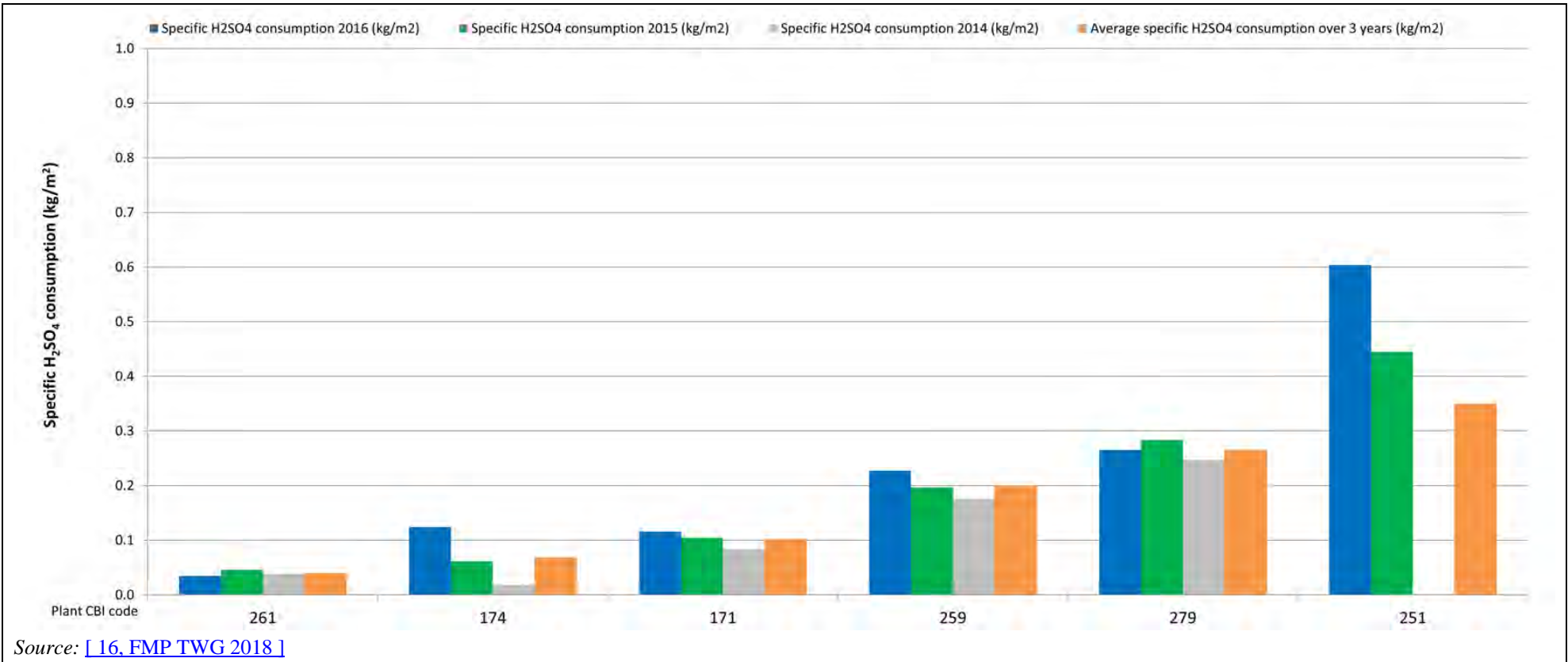


Figure 2.38: Specific H₂SO₄ consumption (kg/m² of treated surface) in HRPO plants

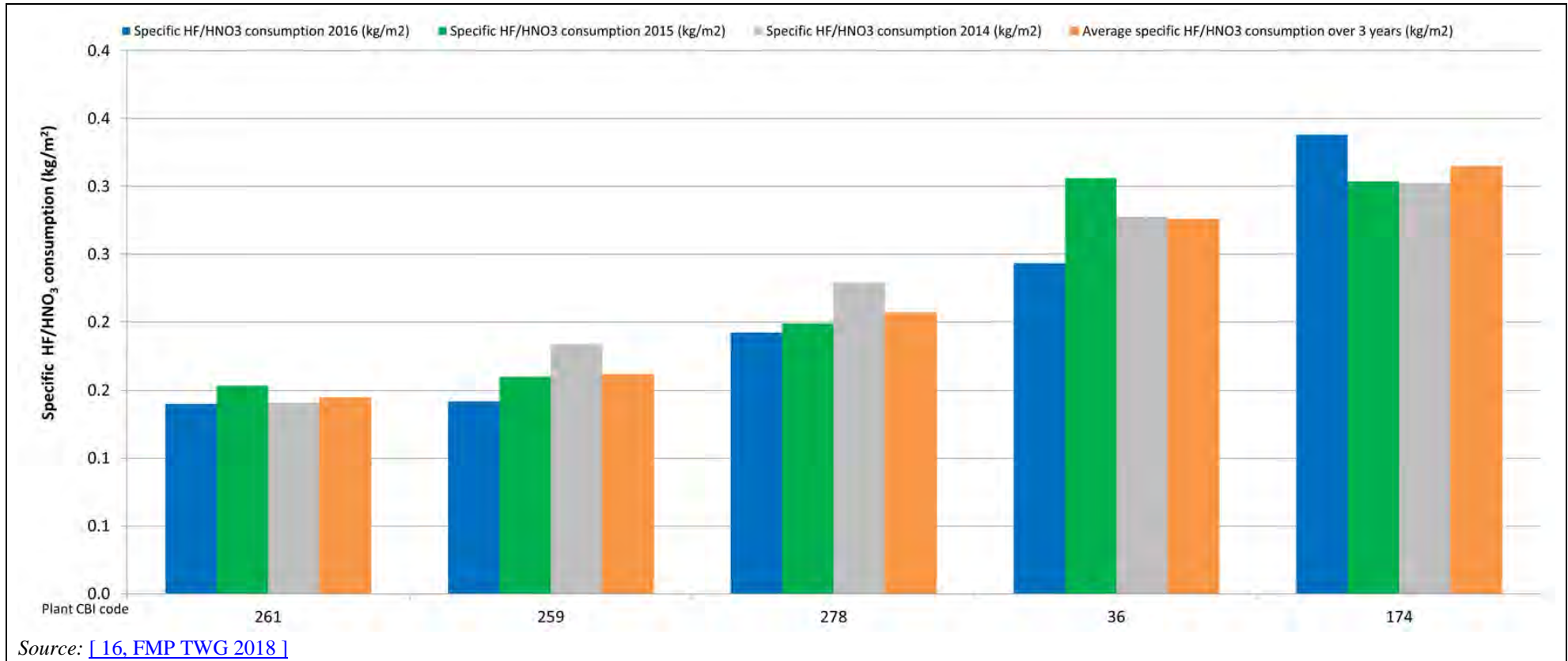
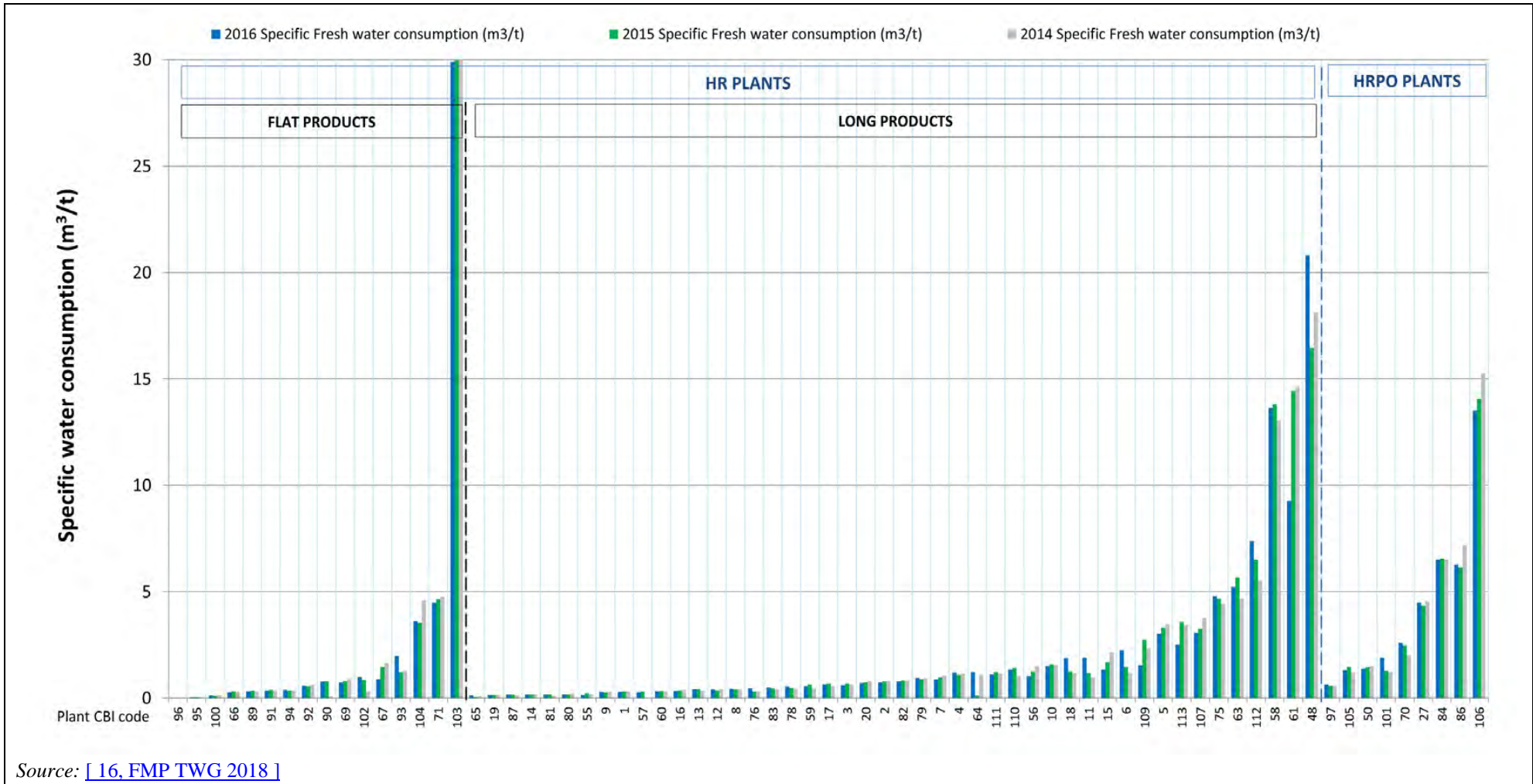


Figure 2.39: Specific HF/HNO₃ consumption (kg/m² of treated surface) in HRPO plants

2.3.4 Water consumption

Figure 2.40 shows the data reported for specific water consumption, at the plant level, for three operating years in hot rolling plants. The specific water consumption ranges from 0.01 m³/t to 30 m³/t, based on data reported by 70 plants in total. More specifically, according to the data collection, among the 24 HR plants that reported to be part of a much larger installation (i.e. integrated iron and steel works), a majority of the plants reported a specific consumption below 2 m³/t, except one plant which reported a very high consumption of 30 m³/t, which is considered to be an outlier. The figure shows the specific water consumption for HR plants (flat and long products) and HRPO plants. The definition of the specific water consumption can be found in Section 9.4.4.2.



Source: [16, FMP TWG 2018]

Figure 2.40: Specific water consumption (m³/t of production) in hot rolling plants

2.3.5 Emissions to air

2.3.5.1 Emissions to air from mechanical processing, scarfing and welding

Dust emissions

During scarfing, wet and corrosive fumes with high proportions of sub-micron particles (size range from 0.5 to 250 microns) are generated. [17, Davy Consultants 1993]

The dust generated by scarfing contains mainly iron oxides with some trace alloying elements present in steel. [18, CITEPA 1994]

The reported data on dust emissions to air from mechanical processing, scarfing and welding are shown in Figure 2.47 and Figure 2.48. In total, dust emissions from 152 emission points have been reported. The dust emission concentrations were within the range 1.5 mg/Nm³ to 350 mg/Nm³ and the emission loads ranged from 1.8 g/h to 8 900 g/h.

Lead emissions

The reported data on lead emissions to air from mechanical processing, scarfing and welding are shown in Figure 2.49. Lead emissions were reported for 23 emission points. Concentrations range from 0.0001 mg/Nm³ to 0.2 mg/Nm³ and the emission loads ranged from 0.002 g/h to 17 g/h.

Nickel emissions

The reported data on nickel emissions to air from mechanical processing, scarfing and welding are shown in Figure 2.50. The emissions of nickel were reported for 34 emission points. The concentrations ranged from 0.09 mg/Nm³ to 1.0 mg/Nm³ and the emission loads ranged from 0.005 g/h to 15 g/h.

2.3.5.2 Emissions to air from heating

The emissions levels presented in this section refers to emissions to air from feedstock heating (i.e. reheating, intermediate heating and post-heating). The figures have been prepared taking into account the actual fuel composition for the reported maximum concentration (100% natural gas or fuels other than 100% natural gas). In addition, to evaluate the potential influence of the product type (e.g. flat products) and air-preheating temperatures on the observed concentration of NO_x emissions to air, additional figures have been prepared.

2.3.5.2.1 Dust emissions

The reported data on dust emissions to air from feedstock heating (reheating, intermediate heating and post-heating) for fuel 100 % natural gas and fuel other than 100 % natural gas are shown in Figure 2.51 and Figure 2.52, respectively.

Dust emissions from feedstock reheating were reported for 71 emission points in total, for plants using 100 % natural gas as fuel. The dust emission concentrations ranged from 0.5 mg/Nm³ to 64 mg/Nm³ and the emission loads ranged from 5 g/h to 1 500 g/h. In reheating furnaces using 100 % natural gas, very little dust emissions are expected. In such case, the source of dust is more related to the re-entrainment of dust present on the feedstock surfaces and to refractory materials of the furnace.

In total, 35 emission points reported dust emission concentrations from feedstock reheating associated when using fuels other than 100 % natural gas. In this case, the dust emission concentrations range from 0.2 mg/Nm³ to 71 mg/Nm³ and the emission loads range from 14 g/h to 3 600 g/h.

Dust emissions from feedstock intermediate heating were reported for 5 emission points using 100 % natural gas. The concentrations ranged from 0.7 mg/Nm³ to 26 mg/Nm³ and the emission loads ranged from 4 g/h to 100 g/h.

Dust emissions from feedstock post-heating were reported for 23 emission points using 100 % natural gas. The concentrations ranged from 0.9 mg/Nm³ to 23 mg/Nm³ and the emission loads ranged from 0.5 g/h to 95 g/h.

2.3.5.2.2 SO₂ emissions

The reported data on SO₂ emissions to air from feedstock heating (reheating, intermediate heating and post-heating) with 100 % natural gas or using fuels other than 100% natural gas are shown in Figure 2.53 and Figure 2.54, respectively.

The SO₂ emission level depends on the sulphur content of the fuel. Reported SO₂ emissions as a function of the fuel type show a difference in the SO₂ emission levels between natural gas and iron and steel process gases, in particular COG and fuel oil. [4, EUROFER 1998], [19, Roederer et al. 1996]

For feedstock reheating using 100 % natural gas, SO₂ emission concentrations were reported for 45 emission points in total. The concentrations ranged from 0.01 mg/Nm³ to 95 mg/Nm³ and the emission loads ranged from 0.2 g/h to 3 127 g/h.

For feedstock reheating, when using fuels other than 100 % natural gas, emission levels were reported for 44 emission points in total. The concentrations ranged from 1.7 mg/Nm³ to 926 mg/Nm³ and the emission loads ranged from 284 g/h to 52 000 g/h.

SO₂ emissions from feedstock intermediate heating were reported for 2 emission points only when using natural gas as fuel. The reported concentration values ranged from 4.2 mg/Nm³ to 13.3 mg/Nm³. Only one emission load of 35 g/h was reported.

SO₂ emissions from feedstock post-heating using 100 % natural gas were reported for 12 emission points in total. The concentrations ranged from 0.07 mg/Nm³ to 56 mg/Nm³ and the emission loads ranged from 2 g/h to 208 g/h.

When the reported maximum concentration from feedstock post-heating was associated with fuels other than 100 % natural gas, 5 emission points reported emission levels with concentrations ranging from 92 mg/Nm³ to 470 mg/Nm³ and emission loads ranging from 536 g/h to 1 900 g/h.

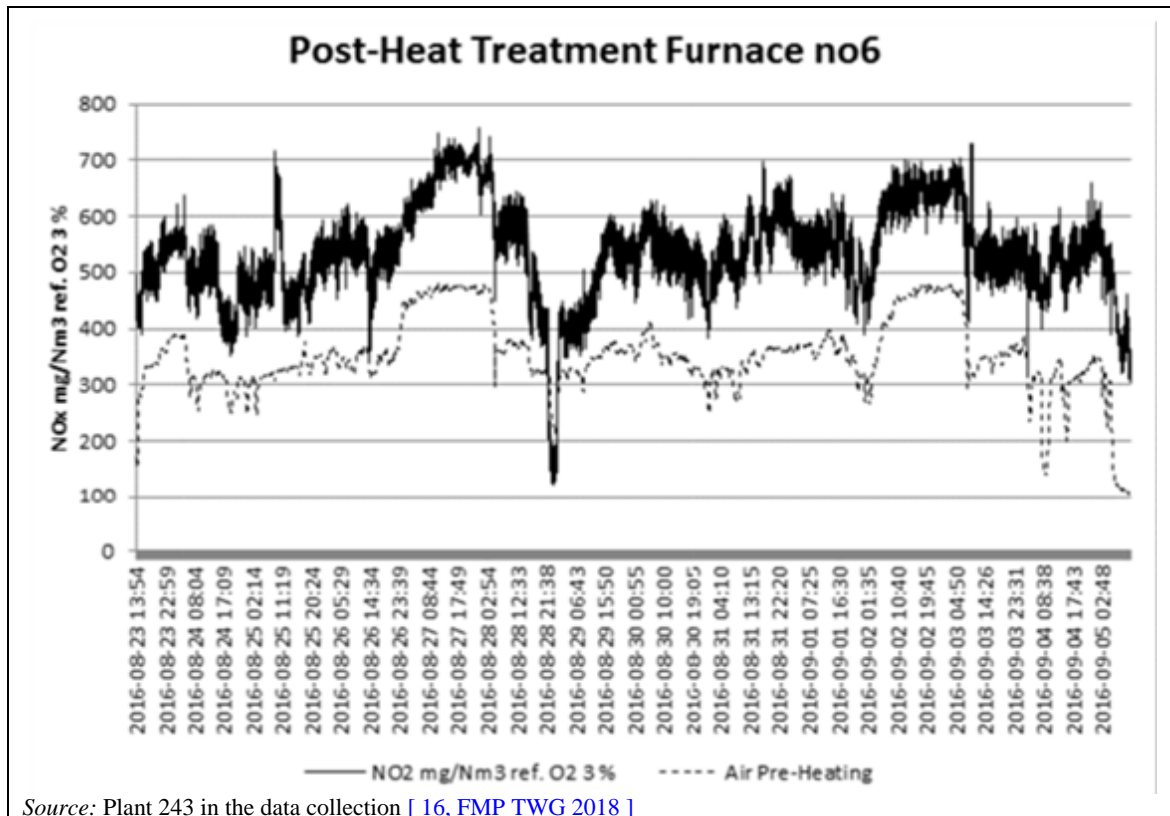
2.3.5.2.3 NO_x emissions

The NO_x emissions from combustion processes may be impacted by several factors, such as the fuel type, the air preheating temperature, the share of hot charging, the furnace design or the burners type. Some burner types, e.g. ceiling burners may emit less NO_x than front or lateral burners. The use of recuperators or regenerative systems to preheat the combustion air increases the thermal efficiency of the furnace, but can also lead to higher NO_x emissions.

Impact of air preheating temperature

In Figure 2.41, an example of the fluctuation of NO_x emissions (expressed in mg/Nm³) in relation to the air preheating temperature (expressed in °C) is shown for a continuous post-heat treatment furnace at SSAB Oxelösund (Furnace 6, corresponding to plant/emission point 243 HR-3 in the data collection). The graph shows that the two curves run almost in parallel suggesting that NO_x emissions and air pre-heating temperatures are linked. According to the plant description for 243 HR, the furnace is normally operated at 300 °C; however, the figure

below shows air preheating temperatures fluctuating between 300 °C up to about 480 °C. In the data collection, three emission concentrations were reported for this emission point in 2016 (490, 605 and 700 mg/Nm³) corresponding to periodic measurement (average values over the sampling period, with sampling duration ranging from 11 to 24 hours). For the years 2014 and 2015, the NO_x emission concentrations reported ranged from 400 mg/Nm³ to 630 mg/Nm³. [16, FMP TWG 2018]



Source: Plant 243 in the data collection [16, FMP TWG 2018]

Figure 2.41: NO_x emissions and air preheating temperature for a post-heating treatment furnace at SSAB Oxelösund, Sweden

Information on the influence of air preheating temperature on NO_x emission concentrations was provided for an Italian plant from the data collection (Feralpi Siderurgica – Plant 203 HR) which provided figures presenting the continuous monitoring of air preheating temperature and NO_x emission concentrations for two different rolling lines. [20, IT, 30-05-2019 2019] The results are shown in Figure 2.42. For these measurements, the NO_x emissions concentrations are not corrected to a standard O₂ reference level of 3 %, the average O₂ concentration measured at the stack was in the range 10 % to 15 %.

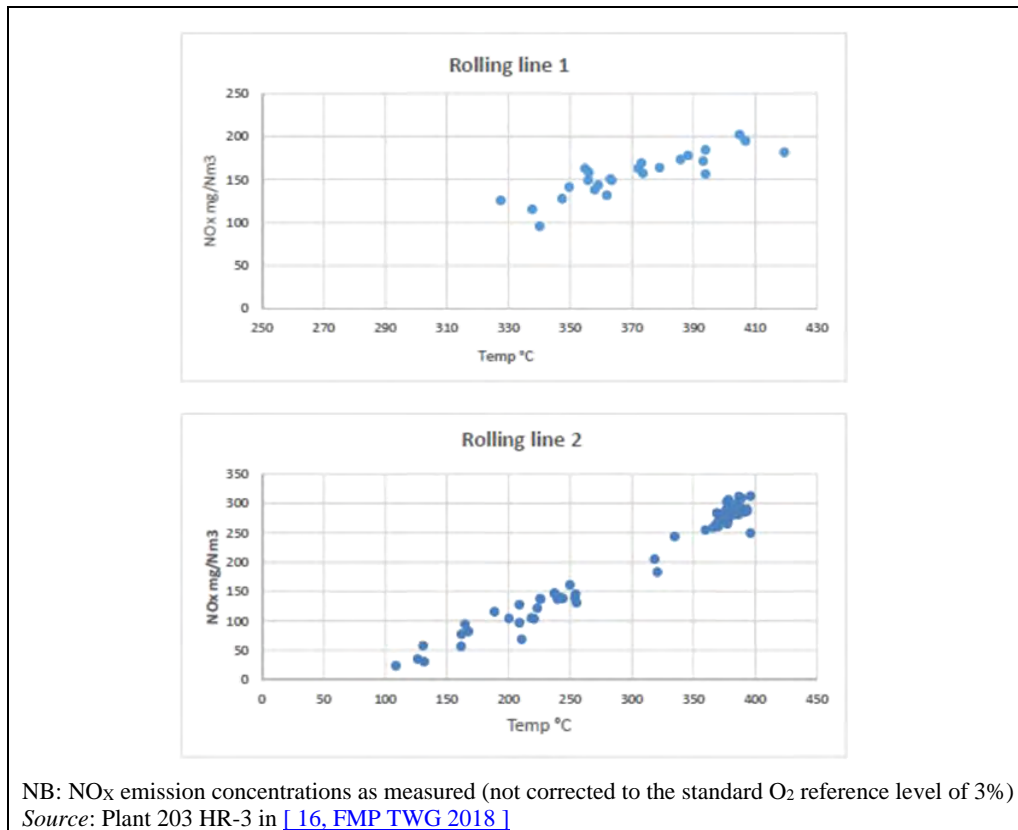


Figure 2.42: NO_x emissions and air preheating temperature

Additional information on the impact of air preheating on NO_x emissions may be found in Section 8.8.2.10.

Impact of flame temperature

Another important factor which can influence the generation of NO_x in combustion processes is an increase of the flame temperature which may result in increased NO_x emission (generation of thermal NO_x). The flame temperature depends on the composition and the type of fuels that are used in the furnace. Figure 2.43 below clearly shows different flame temperatures for natural gas and other iron and steel process gases. The highest flame temperature (ca. 1 900 °C at 3 % O₂) is obtained with 100 % COG whereas the lowest flame temperature (ca. 1 300 °C at 3 % O₂) is observed with 100 % blast furnace gas.

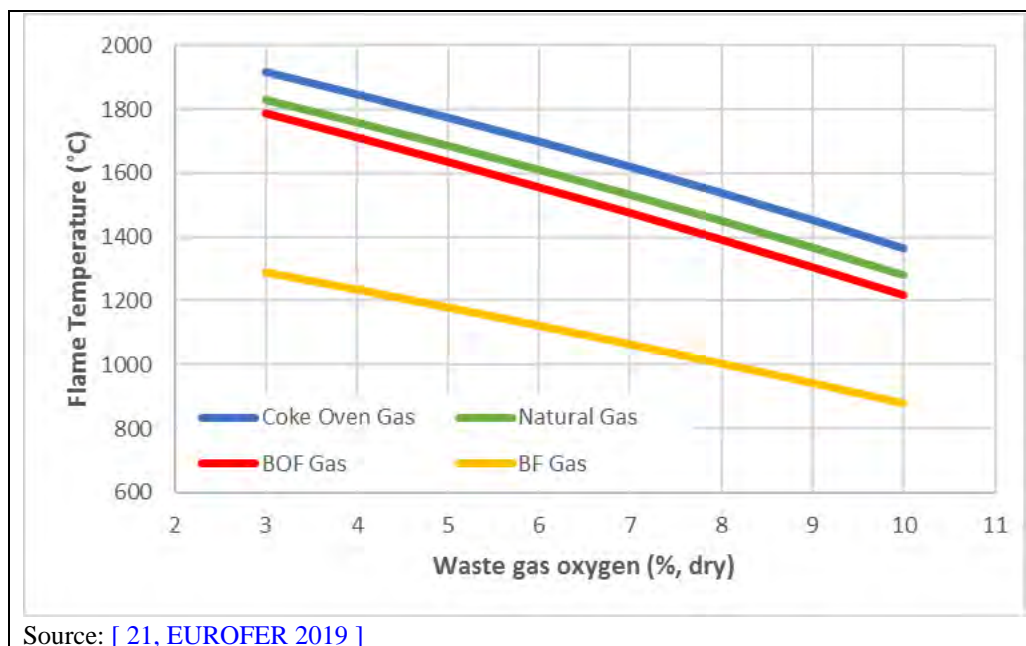


Figure 2.43: Effect of fuel type on flame temperature

Impact of fuel type

The nitrogen content in the fuel can impact the generation of fuel- NO_x . The IS BREF [22, COM 2013] reports nitrogen content as N_2 in COG between 1.5 vol-% and 6.0 vol-%. Data presented in the LCP BREF [23, Lecomte et al. 2017] indicates NH_3 contents of 0-48 mg/ Nm^3 in COG. Information submitted by EUROFER describes COG as a 'fuel with low nitrogen content', containing traces of NH_3 . [21, EUROFER 2019], [62, EUROFER 2019]

In Figure 2.44, the variation of NO_x emission concentrations are depicted for two pusher-type reheating furnaces at SSAB (corresponding to plant/emission point 243 HR-1 in the data collection) as a function of the type of fuel used. In this plant, mixtures of COG (represented in dark grey) and heavy fuel oil (HFO – represented in light grey) are used. Generally, both furnaces use COG as a primary fuel, supplemented by small amounts of HFO. Although for short period of times, a high share of HFO was used. According to the data collection, both furnaces apply air preheating (Furnace 1: 318 °C; Furnace 2: 245 °C). The data presented in these figures is not accompanied by information about the averaging period for the NO_x emission concentrations or concerning the actual variation of air preheating temperature (which could have varied over the year 2016).

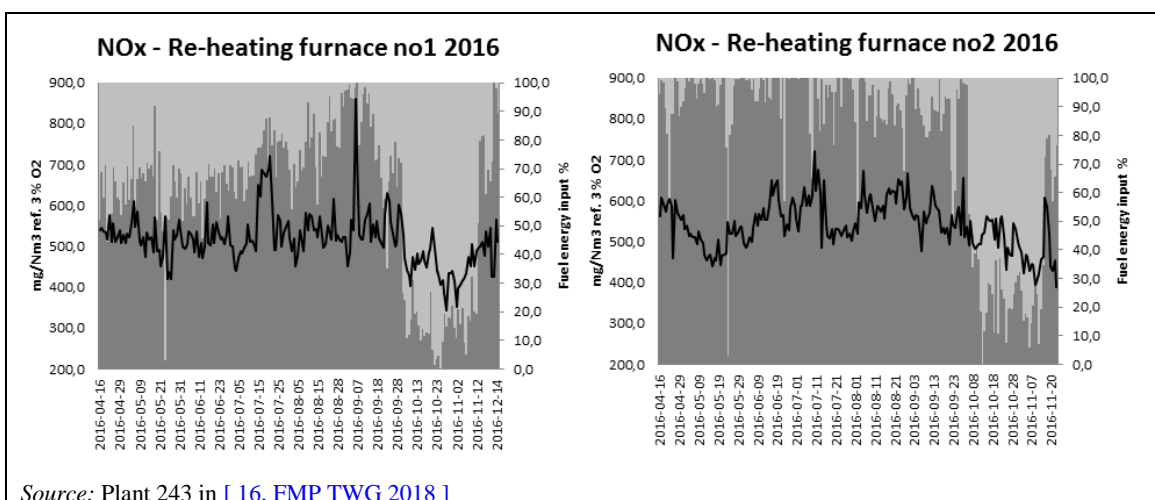


Figure 2.44: NO_x emission concentrations as a function of the type of fuels used in the reheating furnace (COG and HFO)

NO_x emission concentrations in FMP plants may vary over time, e.g. depending on the variability of the fuel composition and/or the mixture of fuels used, especially where IS gases are used. The following figures show examples of the fluctuations of NO_x emissions over time.

Figure 2.45 presents the variation of NO_x emissions over a year for pusher-type furnaces (furnaces 21 and 22, Tata Steel IJmuiden (corresponding to plant/emission point 110 HR2-1 in the data collection – combined stack for the two furnaces). No information on the averaging period was provided for the graph; however, NO_x emissions reported for this emission point for the years 2014, 2015 and 2016 were in the range 180 mg/Nm³ to 290 mg/Nm³, as monthly average. The share of COG for the reporting year ranged from 44 % to 54 %, as yearly average. The plant reported using 20 % share of hot charging at 160 °C, and an air preheating temperature of 350 °C for the pusher-type furnaces.

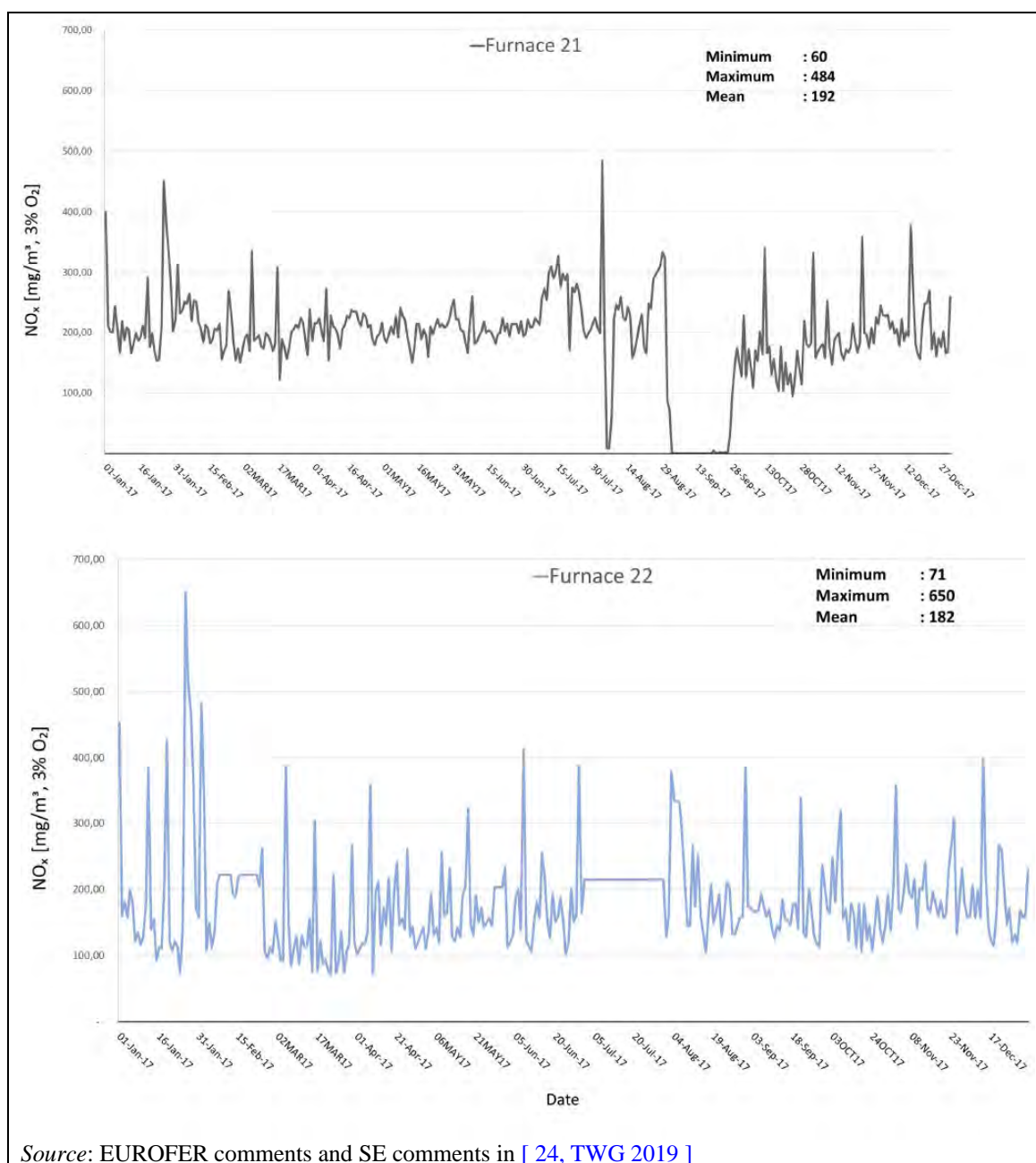


Figure 2.45: Continuously measured NO_x emission concentrations for pusher-type furnaces at Tata Steel IJmuiden (Plant 110 HR2-1) showing NO_x fluctuations over a year

Tata Steel IJmuiden provided further examples, shown in Figure 2.46, of the fluctuation of NO_x emissions for its two walking beam furnaces number 23 and 24 (corresponding to

plant/emission point 110 HR2-2 in the data collection – combined stack for the two furnaces). No information on the averaging period was provided for the graph; however, NO_x emissions reported for this emission point for the years 2014, 2015 and 2016 were in the range 144 mg/Nm³ to 303 mg/Nm³, as monthly average. The share of COG for the reporting year ranged from 62 % to 72 %, as yearly average. The plant reported using 20 % share of hot charging at 160 °C and an air preheating temperature of 450 °C at the walking beam furnaces.

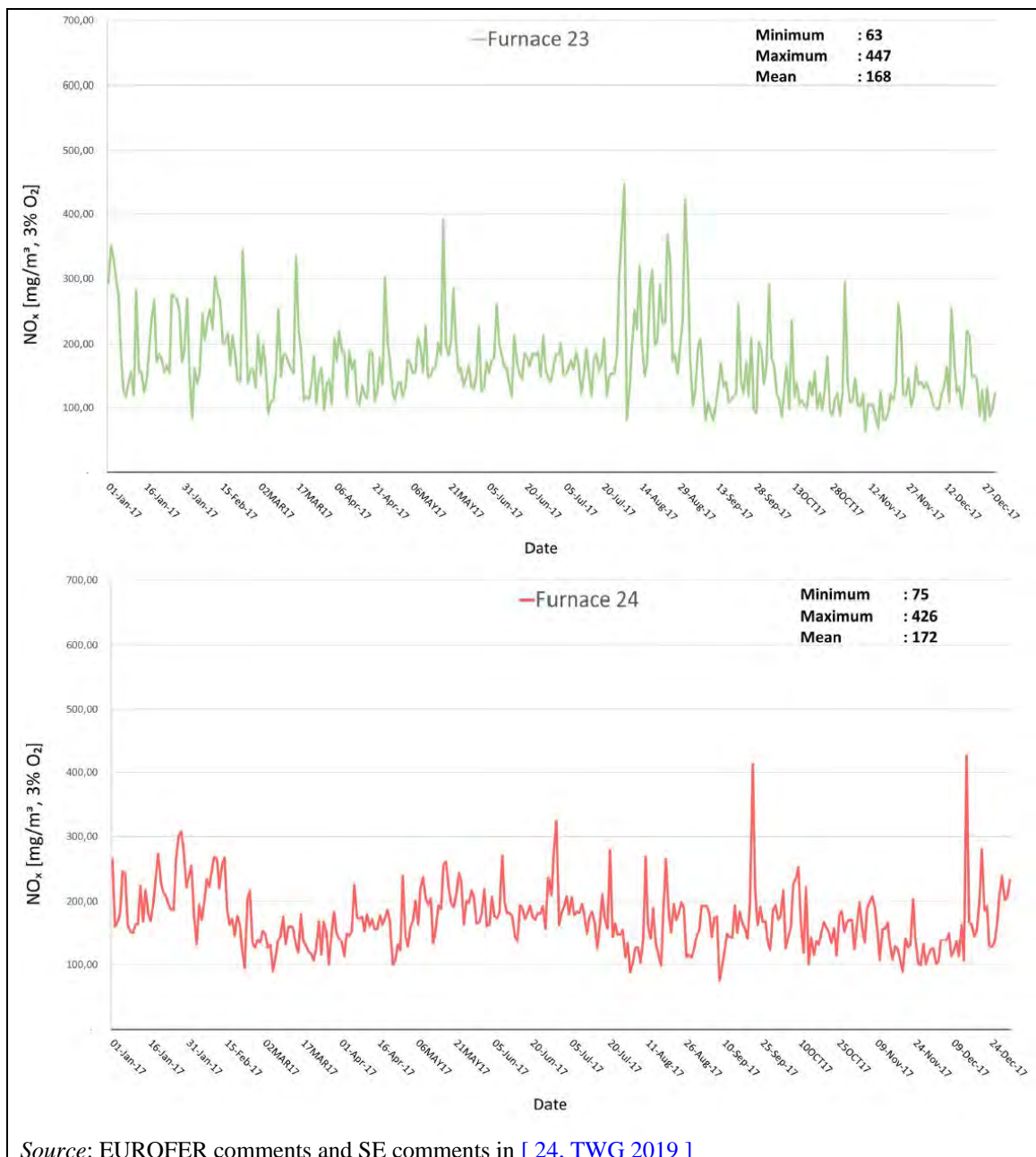


Figure 2.46: Continuously measured NO_x emission concentrations at two walking beam furnaces from Tata Steel IJmuiden (Plant 110 HR2-2) showing NO_x fluctuation over a year

Summary of the NO_x emission concentrations in the FMP data collection

All the data reported in the FMP data collection on NO_x emissions to air from feedstock heating (reheating, intermediate heating and post-heating) with 100 % natural gas are shown in Figure 2.55, Figure 2.56 and Figure 2.57. In total, data from feedstock reheating were reported for 121 emission points, with emission concentrations ranging from 10 mg/Nm³ to 1 370 mg/Nm³ and emission loads ranging from 22 g/h to 83 000 g/h. Data from feedstock intermediate heating were reported for 13 emission points, with emission concentrations ranging from 30 mg/Nm³ to

429 mg/Nm³ and emission loads ranging from 80 g/h to 7 600 g/h. Data from feedstock post-heating were reported for 53 emission points, with emission concentrations ranging from 11 mg/Nm³ to 433 mg/Nm³ and emission loads ranging from 16 g/h to 19 000 g/h.

The reported data on NO_x emissions to air from feedstock heating (reheating, intermediate heating and post-heating) for fuels other than 100 % natural gas are shown in Figure 2.58.

For feedstock reheating, data were reported for 71 emission points, with emission concentrations ranging from 91 mg/Nm³ to 1 314 mg/Nm³ and emission loads ranging from 1 917 g/h to 106 000 g/h. Two emission points reported NO_x emission concentrations from feedstock intermediate heating when using 100 % LPG. In this case, the reported emission concentrations were 780 mg/Nm³ and 990 mg/Nm³, and the emission loads ranged from 435 g/h and 850 g/h, respectively.

Emission levels from feedstock post-heating were reported for 10 emission points, with emission concentrations ranging from 104 mg/Nm³ to 2 222 mg/Nm³ and emission loads ranging from 324 g/h to 5 700 g/h.

Table 2.11 and Table 2.12 summarise the reported ranges for concentration and load levels of NO_x emissions to air from feedstock reheating of flat and long products respectively as well as from feedstock heating without air preheating and with air preheating. It is important to note that the air preheating temperature provided by the operators via the data collection do not necessarily correspond to the waste gas temperature when NO_x emission measurements were carried out. In addition, Table 2.13 summarises the median and 90th percentile concentration and emission load levels of NO_x emissions to air from feedstock reheating of flat and long products with air preheating for temperatures below or above 450°C.

Additional figures showing the reported data on NO_x emissions to air from feedstock reheating (reheating, intermediate heating and post-heating) when considering the type of fuel used, the air preheating and the target temperature of the feedstock exiting the furnace are summarised in Section 2.3.5.4 and include:

- Figure 2.59 and Figure 2.60: NO_x emissions to air from feedstock reheating of flat products with 100 % natural gas or with fuels other than 100 % natural gas, respectively.
- Figure 2.61, and Figure 2.62: NO_x emissions to air from feedstock reheating without air preheating with 100 % natural gas or fuels other than 100 % natural gas, respectively.
- Figure 2.63, Figure 2.64 and Figure 2.65: NO_x emissions to air from feedstock reheating with 100 % natural gas including the air preheating temperature and the target temperature of the feedstock exiting the furnace.
- Figure 2.66: NO_x emissions to air from feedstock reheating and post-heating with fuels other than 100 % natural gas including the air preheating temperature and the target temperature of the feedstock exiting the furnace.

Table 2.11: Ranges of NO_x emissions to air from feedstock heating for flat products, with and without air preheating

	Reheating			Intermediate			Post-heating		
	Natural gas								
	Number of emission points	Concentration range (mg/Nm ³)	Mass flow range (g/h)	Number of emission points	Concentration range (mg/Nm ³)	Mass flow range (g/h)	Number of emission points	Concentration range (mg/Nm ³)	Mass flow range (g/h)
Flat products	22	43-1 360	180-38 500	1	10-30	58-80	12	13-390	16-4 720
<i>Without air preheating</i>	1	140	1 232	NI	NI	NI	4	86-287	16-505
<i>With air preheating (T<450°C)</i>	16	43-1 360	180-38 500	1	10-30	58-80	8	13-390	176-4 720
<i>With air preheating (450°C < T < 600°C)</i>	3	68-330	431-12 500	NI	NI	NI	NI	NI	NI
<i>With air preheating (T>600°C)</i>	2	130-185	1 150-3 900	NI	NI	NI	NI	NI	NI
	Fuels other than 100 % natural gas								
Flat products	43	41-1 066	1 918-106 750	2	687-990	377-850	7	58-1 400	283-2 800
<i>Without air preheating</i>	NI	NI	NI	2	687-990	377-850	1	206	351
<i>With air preheating (T<450°C)</i>	34	41-861	1 918-106 750	NI	NI	NI	5	58-700	283-5 750
<i>With air preheating T (450°C < T < 600°C)</i>	9	54-1 066	6 800-106 150	NI	NI	NI	NI	NI	NI
<i>With air preheating (T>600°C)</i>	NI	NI	NI	NI	NI	NI	1	417-1 400	1 790-2 800

NI: No information provided
 Source: [16, FMP TWG 2018]

Table 2.12: Ranges of NO_x emissions to air from feedstock heating for long products, with and without air preheating

	Reheating			Intermediate			Post-heating		
	Natural gas								
	Number of emission points	Concentration range (mg/Nm ³)	Mass flow range (g/h)	Number of emission points	Concentration range (mg/Nm ³)	Mass flow range (g/h)	Number of emission points	Concentration range (mg/Nm ³)	Mass flow range (g/h)
Long products	67	4-1 260	12-33 915	10	48-429	247-4 650	23	8-292	14-1 552
<i>Without air preheating</i>	4	127-286	22-3 870	4	125-429	247-4 650	8	39-292	64-300
<i>With air preheating (T<450°C)</i>	49	4-892	12-33 915	6	48-390	420-3 435	12	8-256	14-1 552
<i>With air preheating (450°C < T < 600°C)</i>	7	49-395	805-10 227	NI	NI	NI	3	120-224	NI
<i>With air preheating (T>600°C)</i>	7	74-1 260	1 160-7 145	NI	NI	NI	NI	NI	NI
	Fuels other than 100 % natural gas								
Long products	13	15-1 059	1 700-8 060	NI	NI	NI	3	217-2 220	358-5 150
<i>Without air preheating</i>	4	158-1 059	NI	NI	NI	NI	1	217-2 220	358-790
<i>With air preheating (T<450°C)</i>	9	15-338	1 700-8 060	NI	NI	NI	2	309-352	2 120-5 150
<i>With air preheating T (450°C < T < 600°C)</i>	NI	NI	NI	NI	NI	NI	NI	NI	NI
<i>With air preheating (T>600°C)</i>	NI	NI	NI	NI	NI	NI	NI	NI	NI

NI: No information provided
 Source: [16, FMP TWG 2018]

Table 2.13: NO_x emissions (median and 90th percentile) to air from feedstock reheating for flat and long products, with air preheating

	Natural gas				Fuels other than 100 % natural gas			
	Concentration (mg/Nm ³)		Mass flow (g/h)		Concentration (mg/Nm ³)		Mass flow (g/h)	
	Median	90 th percentile	Median	90 th percentile	Median	90 th percentile	Median	90 th percentile
<i>Flat products</i>								
<i>With air preheating (T<450°C)</i>	310	630	3 070	15 750	325	615	14 390	47 950
<i>With air preheating (T>450°C)</i>	157	239	1 337	10 131	278	602	18 477	52 536
<i>Long products</i>								
<i>With air preheating (T<450°C)</i>	221	392	4 067	16 460	196	336	4 997	6 904
<i>With air preheating (T>450°C)</i>	262	487	4 321	8 270	NI	NI	NI	NI
NI: No information provided Source: [16, FMP TWG 2018]								

2.3.5.2.4 CO emissions

The reported data on CO emissions to air from feedstock heating (reheating, intermediate heating and post-heating) with 100% natural gas are shown in Figure 2.67 and Figure 2.68.

For feedstock reheating, data were reported for 74 emission points in total, with CO emission concentrations ranging from 0.5 mg/Nm³ to 1 416 mg/Nm³ and emission loads ranging from 6 g/h to 14 160 g/h. For feedstock intermediate heating, data were reported for 9 emission points in total, with CO emission concentrations varying from 9 mg/Nm³ to 1 394 mg/Nm³ and emission loads ranging from 53 g/h to 6 400 g/h. For feedstock post-heating, data were reported for 25 emission points in total, with emission concentrations ranging from 3 mg/Nm³ to 2 450 mg/Nm³ and emission loads ranging from 2 g/h to 2 450 g/h.

The reported data on CO emissions to air from feedstock heating (reheating, intermediate heating and post-heating) for fuel other than 100% natural gas are shown in Figure 2.69. Data were reported for 37 emission points in total, with emission concentrations ranging from 1 mg/Nm³ to 741 mg/Nm³ and emission loads ranging from 38 g/h to 24 680 g/h. No data were reported from feedstock intermediate heating. For feedstock post-heating, data were available for 8 emission points in total, showing emission concentrations within the range 10 mg/Nm³ to 15 000 mg/Nm³ and emission loads between 26 g/h and 69 000 g/h.

2.3.5.3 Emissions to air from pickling

The data reported in the FMP data collection on emissions to air from pickling for the production of hot rolled pickled and oiled steel (HRPO) can be found in the respective section for cold rolling (see Section 3.3.5.3).

2.3.5.4 Figures with air emission levels

The figures related to emissions to air which are presented here are composed of several sections. The upper part of the figure always shows the maximum concentration for each of the three reporting years and the average value obtained over the reporting period. For combustion processes, the plotted concentration values always refer to a oxygen reference level of 3 % and information on the type of fuel(s) used is also included. Measurements reported without giving information about the oxygen level measured or the fuel composition used are not taken into

account. Below the x-axis, additional contextual information is included such as the emission point code, the type of steel products and the steel category, the number of measurements done each year and the BAT candidates used. In the lower part of the figure, additional information may be also given such as the mass flow values, both for the maximum concentration obtained over the reporting period and the average mass flow over the three reporting years. Typically, a figure is available for cases where 100 % natural gas is used, and a separate figure is provided for fuels other than 100 % natural gas indicating clearly the type of fuel mix used (expressed as percentages of energy input). In the case of figures related to NO_x emissions, an additional graph showing the corresponding emissions of CO is provided in the lower part of of the figure. In all cases, the figures are sorted in ascending order of the maximum concentration values for the 3 operating years. The explanations for the abbreviations used in the graphs in hot rolling can be found in the Glossary.

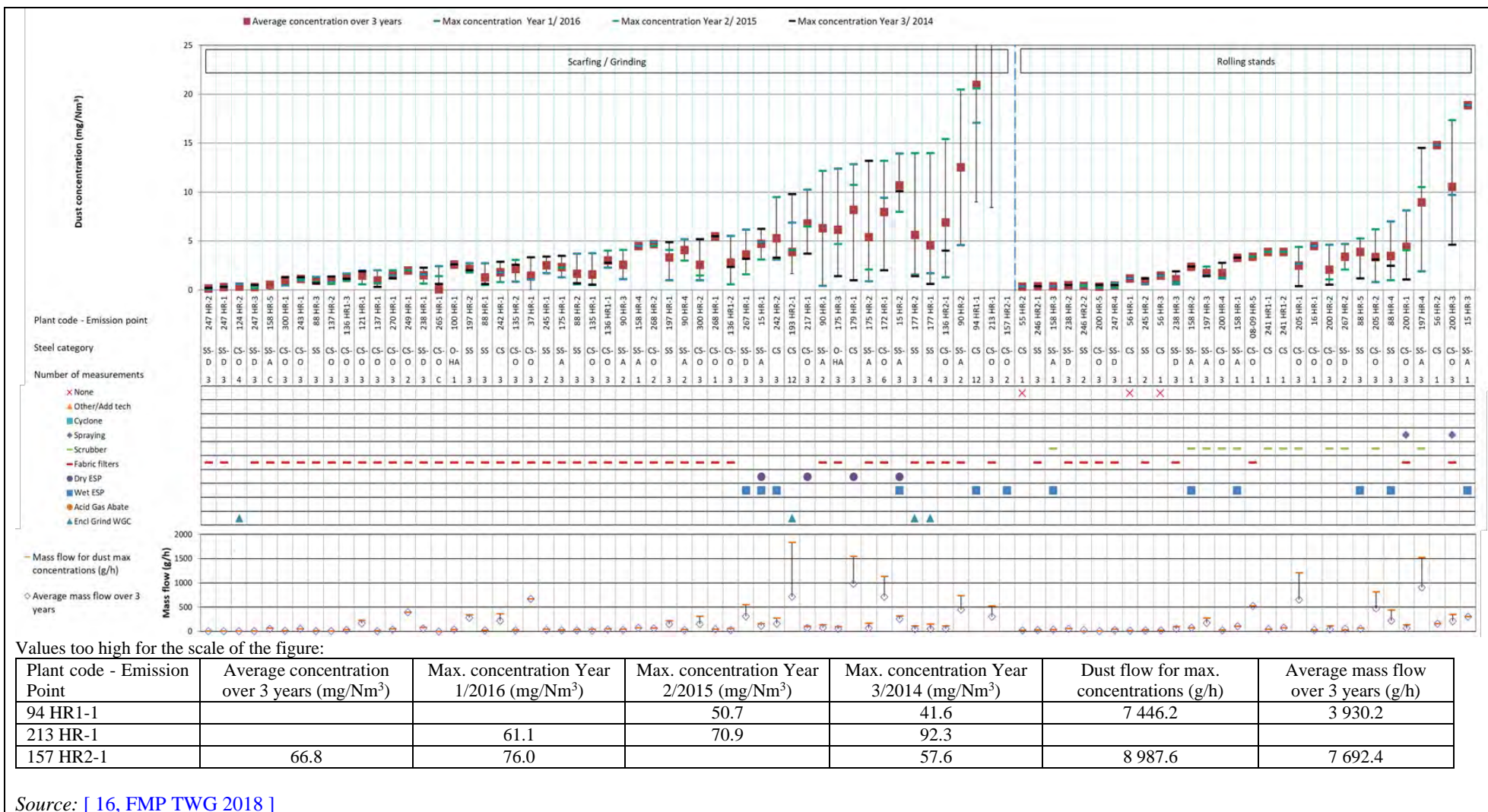
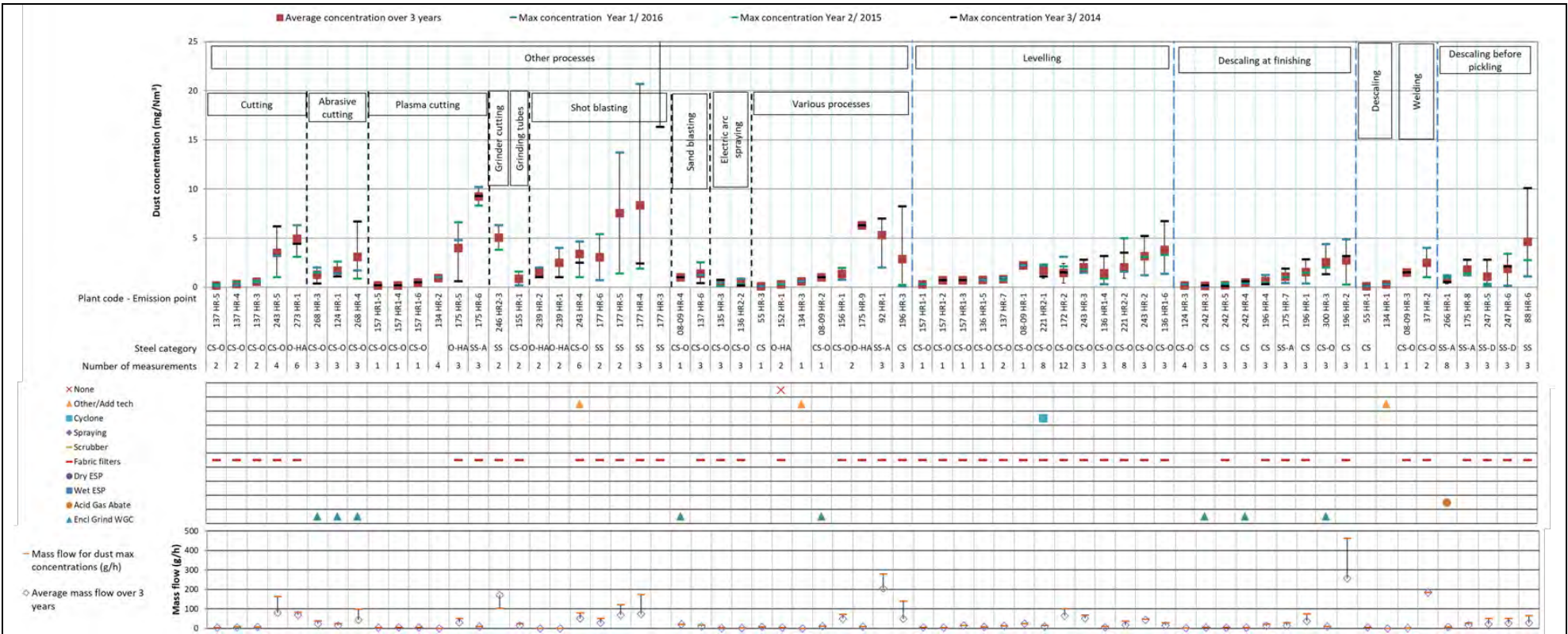


Figure 2.47: Dust emissions from mechanical processing, scarfing and welding (in mg/Nm³) - Part 1 of 2



Values too high for the scale of the figure:

Plant code - Emission Point	Average concentration over 3 years (mg/Nm ³)	Max. concentration Year 1/2016 (mg/Nm ³)	Max. concentration Year 2/2015 (mg/Nm ³)	Max. concentration Year 3/2014 (mg/Nm ³)	Dust flow for max. concentrations (g/h)	Average mass flow over 3 years (g/h)
177 HR-3	156.7	118.3	335.5		2 683.7	1 216.5

Source: [16, FMP TWG 2018]

Figure 2.48: Dust emissions from mechanical processing, scarfing and welding (in mg/Nm³) - Part 2 of 2

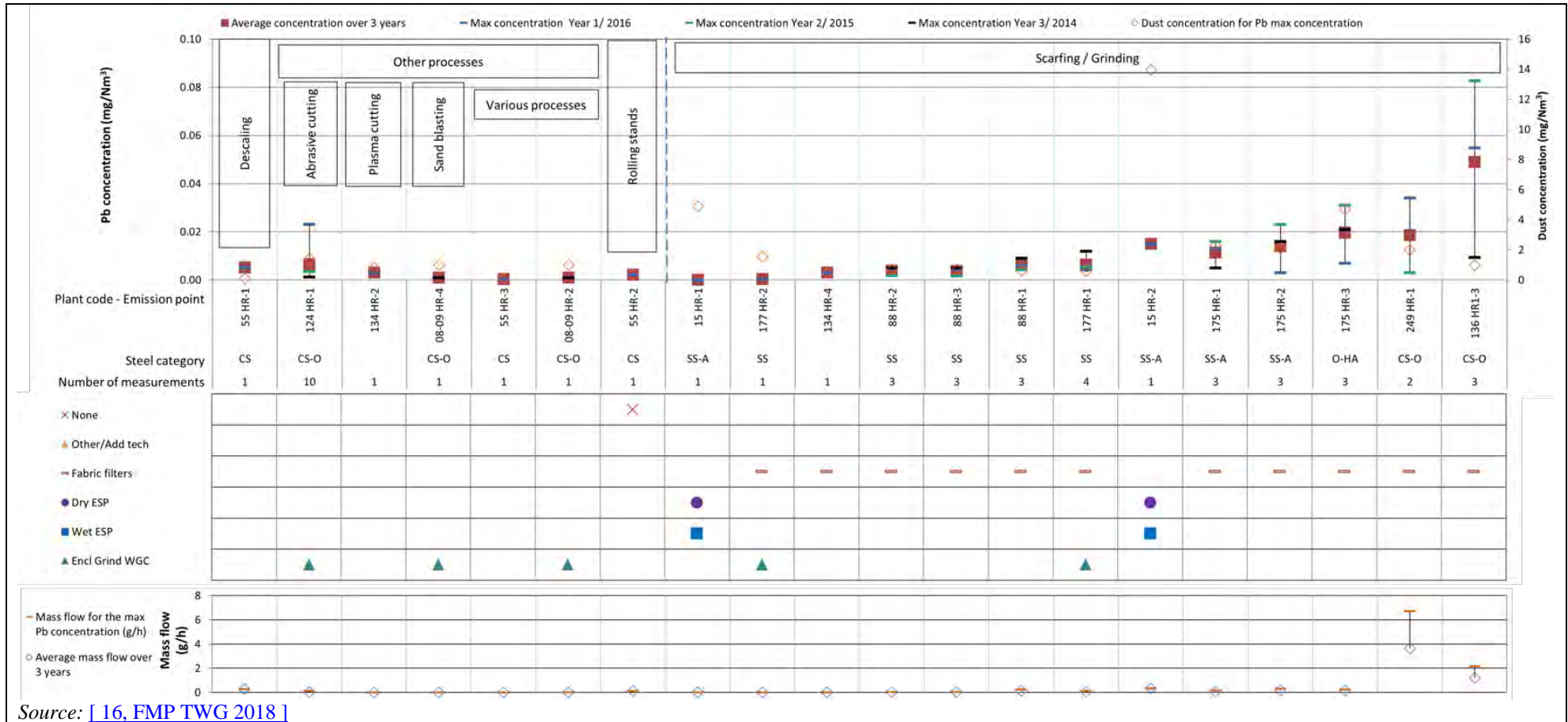


Figure 2.49: Lead emissions from mechanical processing, scarfing and welding (in mg/Nm³)

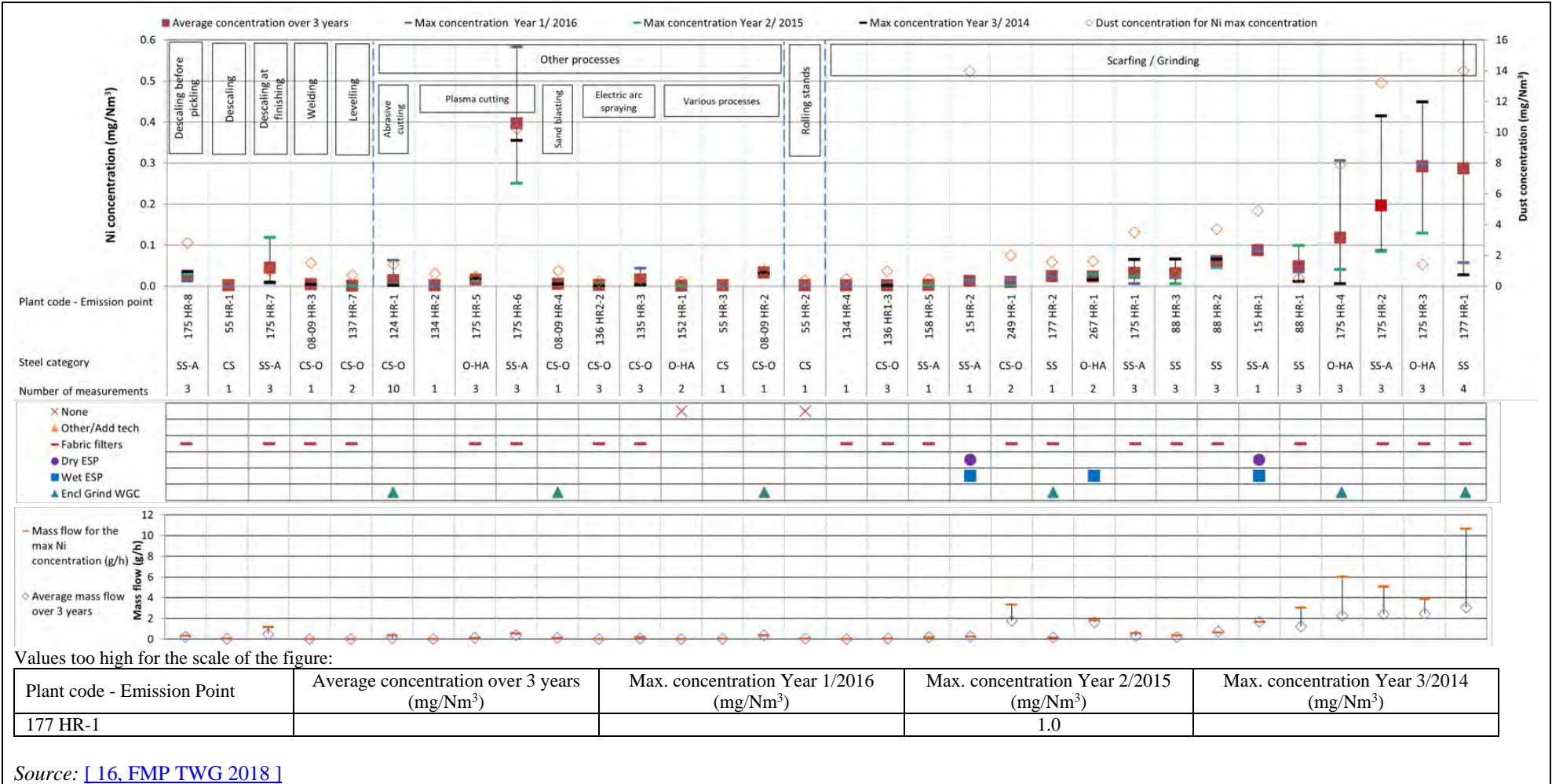
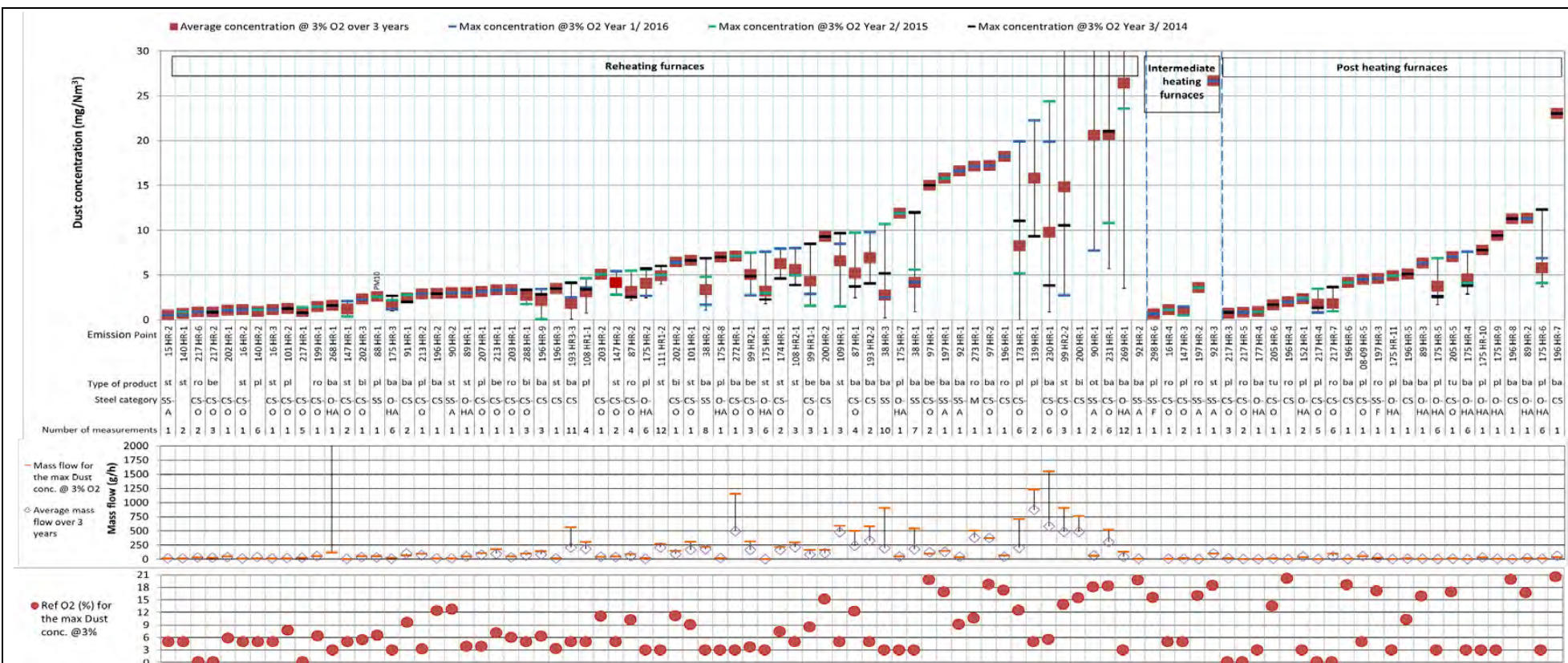


Figure 2.50: Nickel emissions from mechanical processing, scarfing and welding (in mg/Nm³)

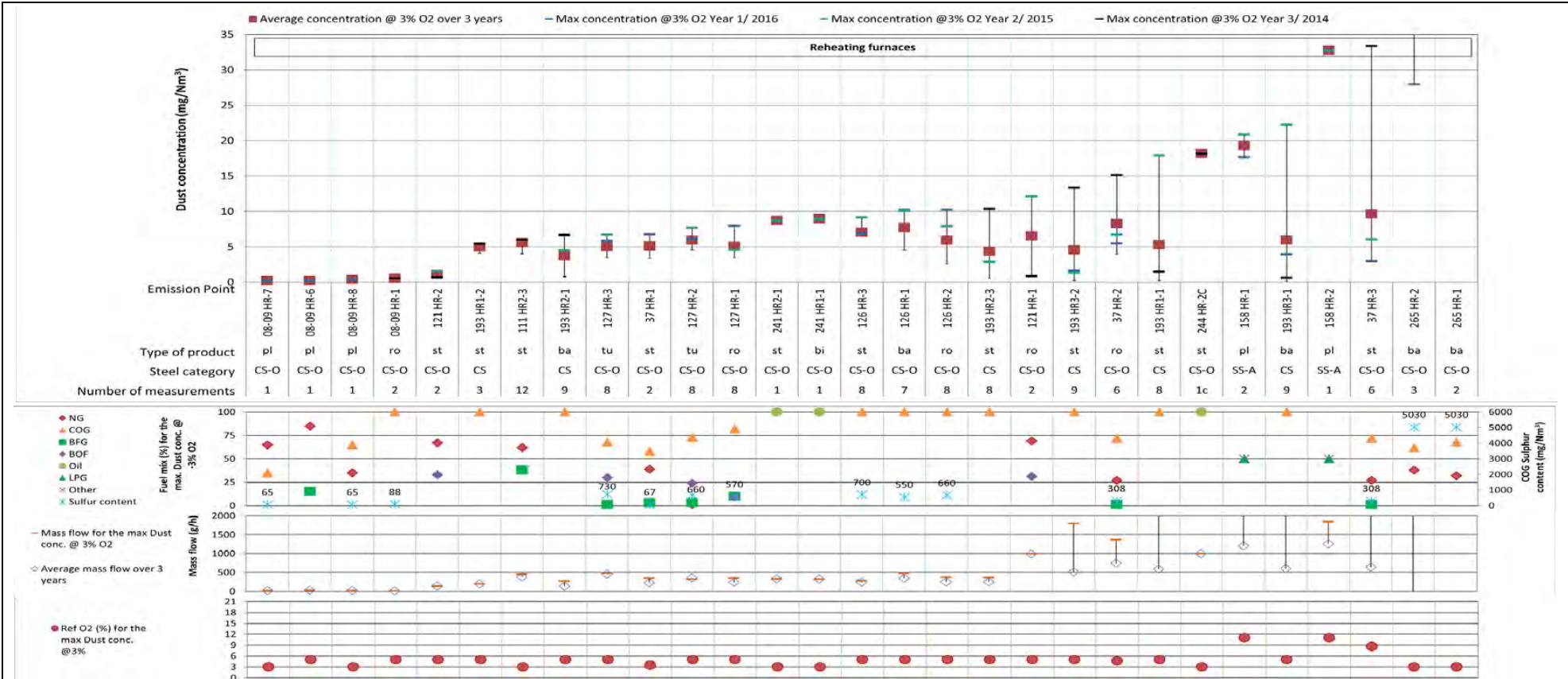


Values too high for the scale of the figure:

Plant code - Emission Point	Average concentration over 3 years (mg/Nm ³)	Max. concentration Year 1/2016 (mg/Nm ³)	Max. concentration Year 2/2015 (mg/Nm ³)	Max. concentration Year 3/2014 (mg/Nm ³)	Dust flow for max. concentrations (g/h)	Average mass flow over 3 years (g/h)
268 HR-1					2 758.0 ⁽¹⁾	⁽¹⁾ The mass flow corresponds to a measurement of 64 mg/Nm ³ (O ₂ level is unknown).
99 HR2-2			31.2		907.0	
200 HR-1	33.4		33.4		762.0	
90 HR-1			33.5			
231 HR-1		60.0				
269 HR-1		58.9		63.0		
92 HR-2	64.5	64.5				

Source: [16, FMP TWG 2018]

Figure 2.51: Dust emissions from feedstock heating (in mg/Nm³ at 3 % oxygen) for 100% natural gas

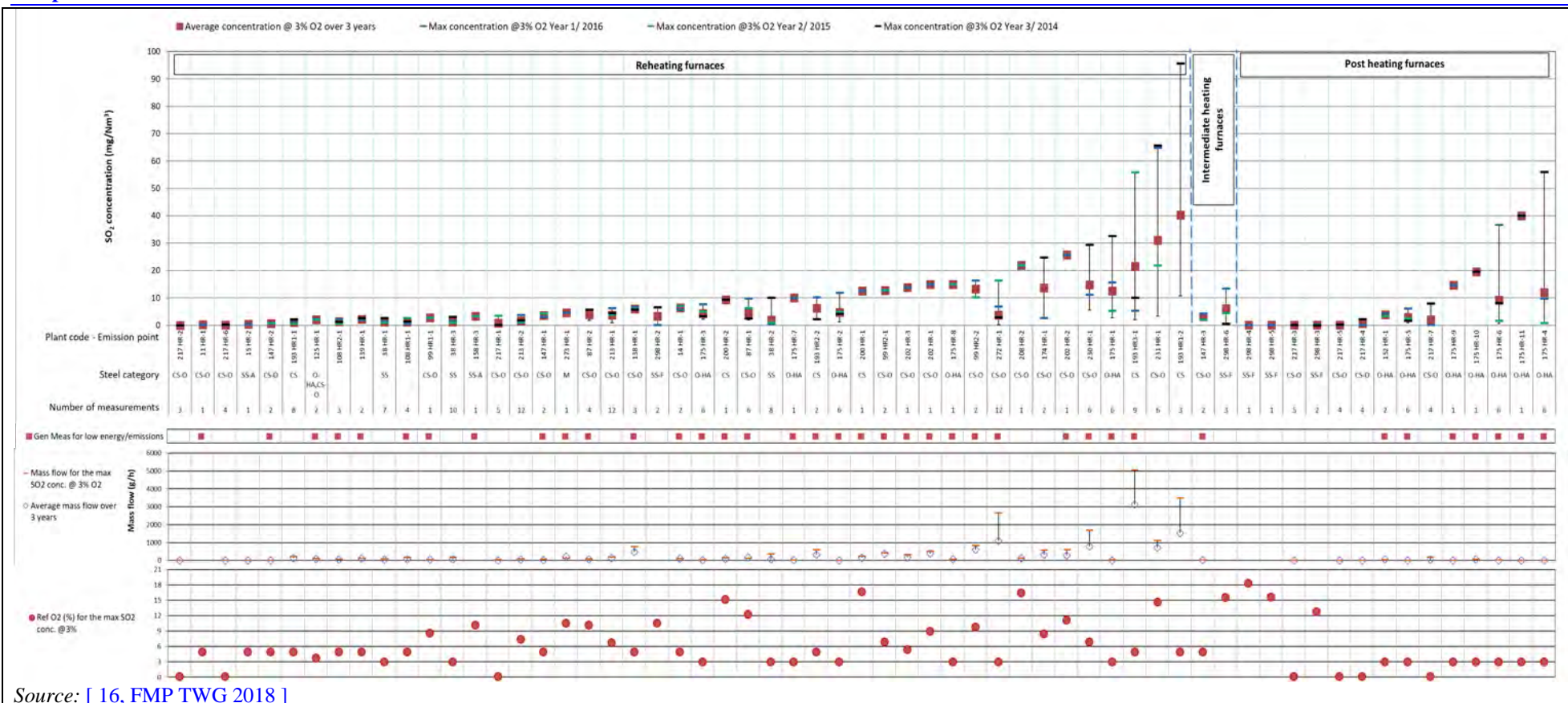


Values too high for the scale of the figure:

Plant code - Emission Point	Average concentration over 3 years (mg/Nm ³)	Max. concentration Year 1/2016 (mg/Nm ³)	Max. concentration Year 2/2015 (mg/Nm ³)	Max. concentration Year 3/2014 (mg/Nm ³)	Dust flow for max. concentrations (g/h)	Average mass flow over 3 years (g/h)
193 HR-1					2 103.0	
158 HR-1					2 156.0	
193 HR3					2 012.0	
37 HR-3					2 300.0	
265 HR-2	51.7		68.0	59.0		8 315.0
265 HR-1	60.5		71.8	49.1	3 615.0	3 633.0

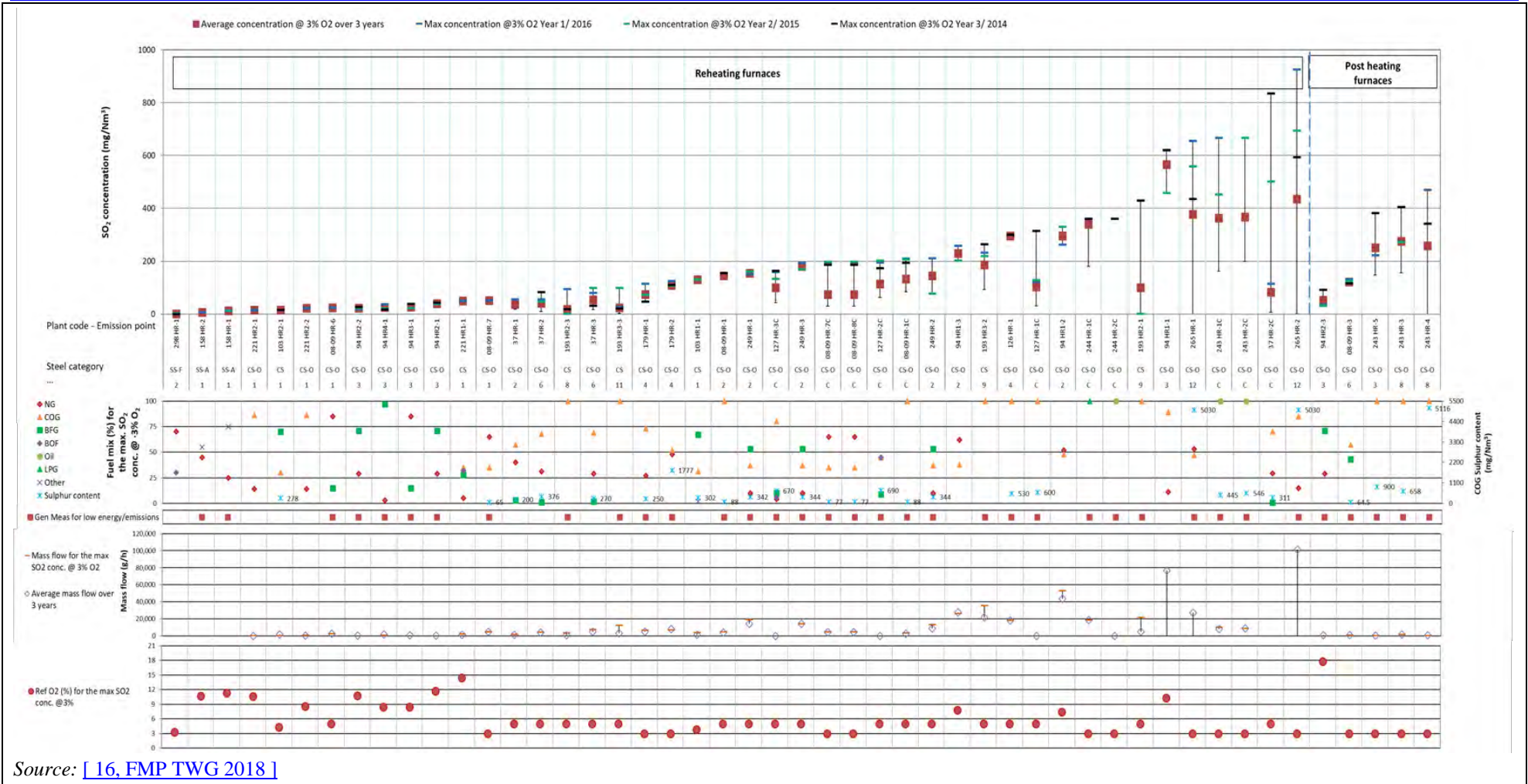
Source: [16, FMP TWG 2018]

Figure 2.52: Dust emissions from feedstock heating (in mg/Nm³ at 3 % oxygen) for fuels other than 100 % natural gas



Source: [16, FMP TWG 2018]

Figure 2.53: SO₂ emissions from feedstock heating (in mg/Nm³ at 3 % oxygen) for 100 % natural gas



Source: [16, FMP TWG 2018]

Figure 2.54: SO₂ emissions from feedstock heating (in mg/Nm³ at 3 % oxygen) for fuels other than 100 % natural gas

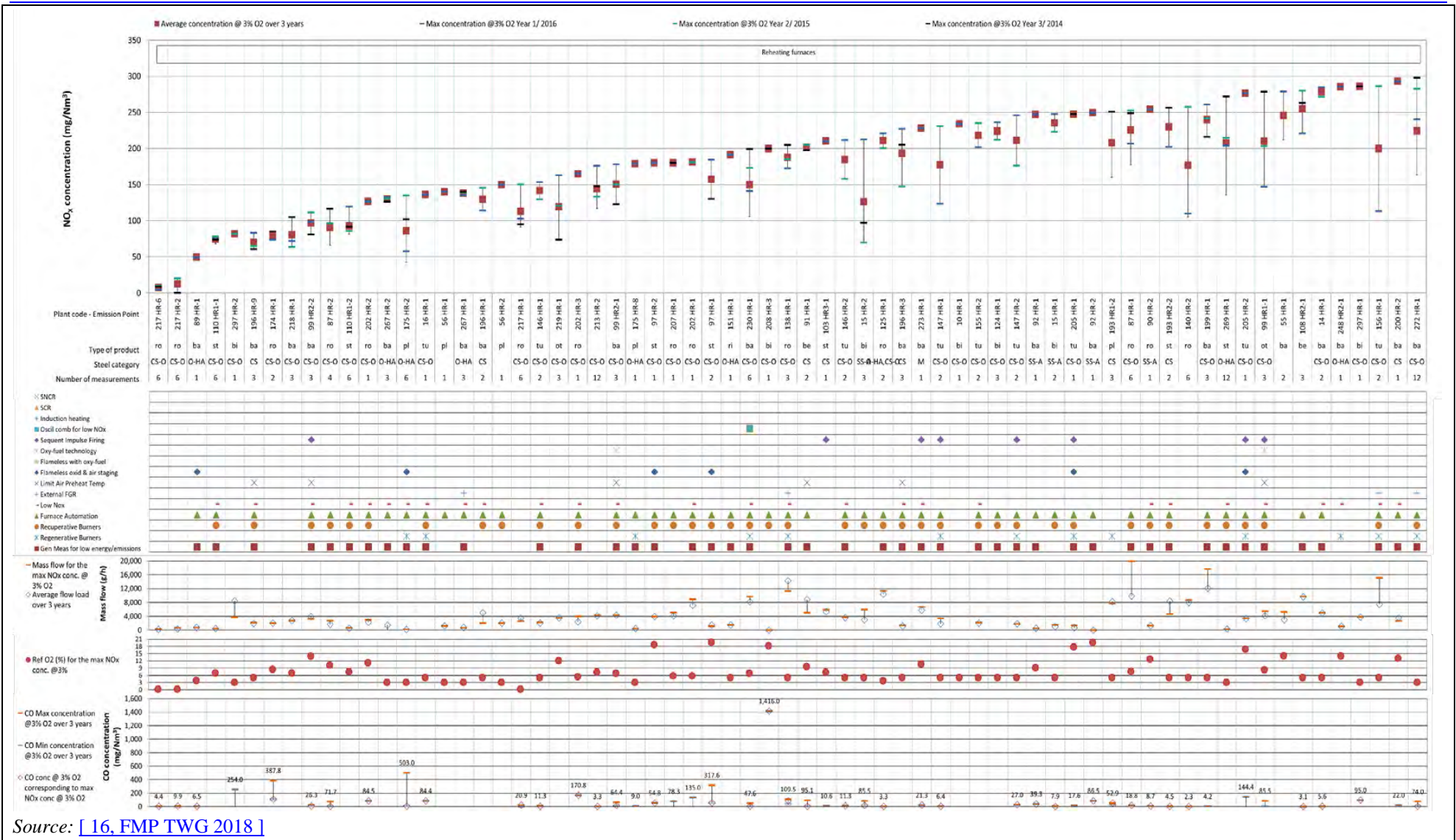
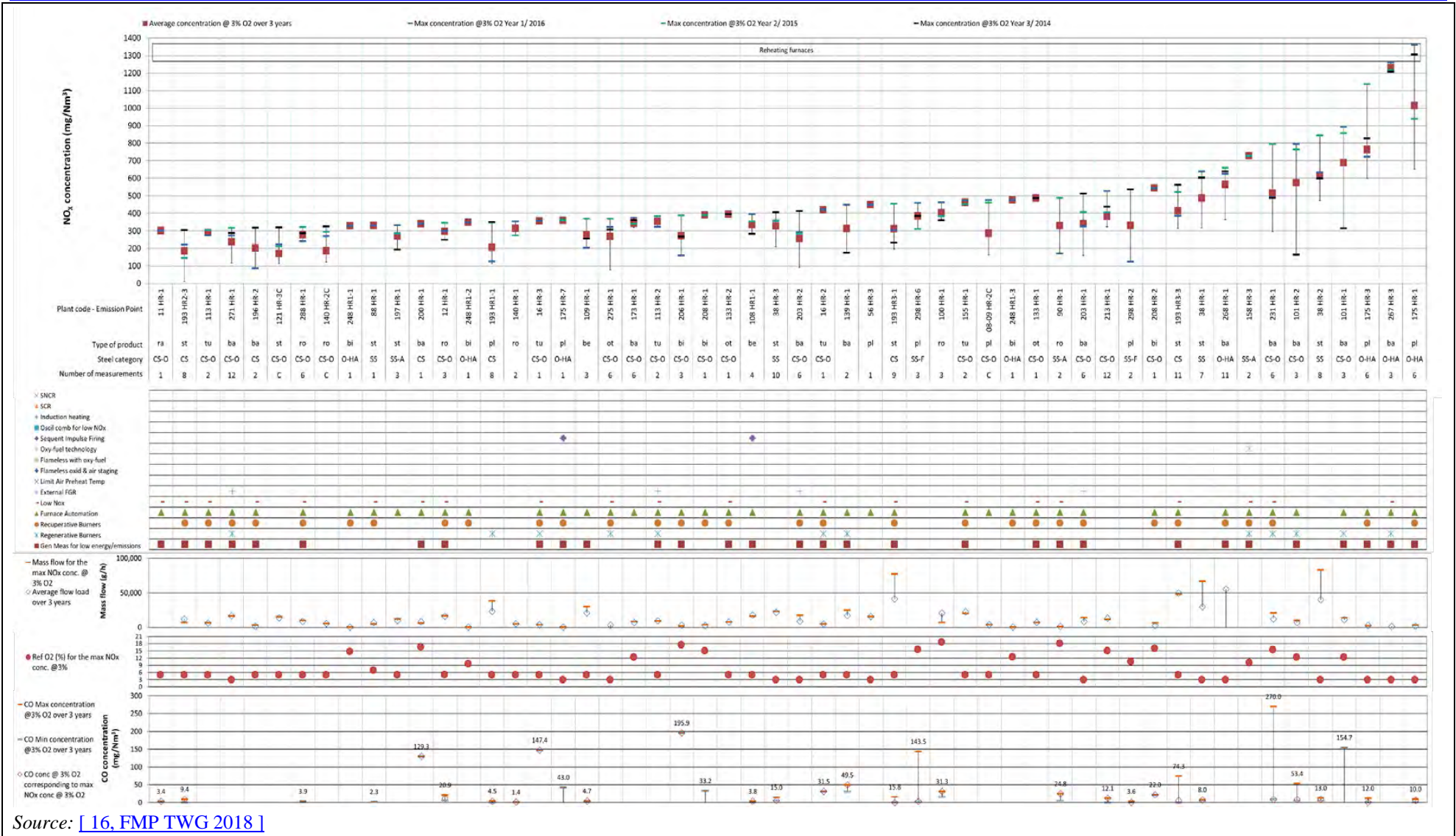
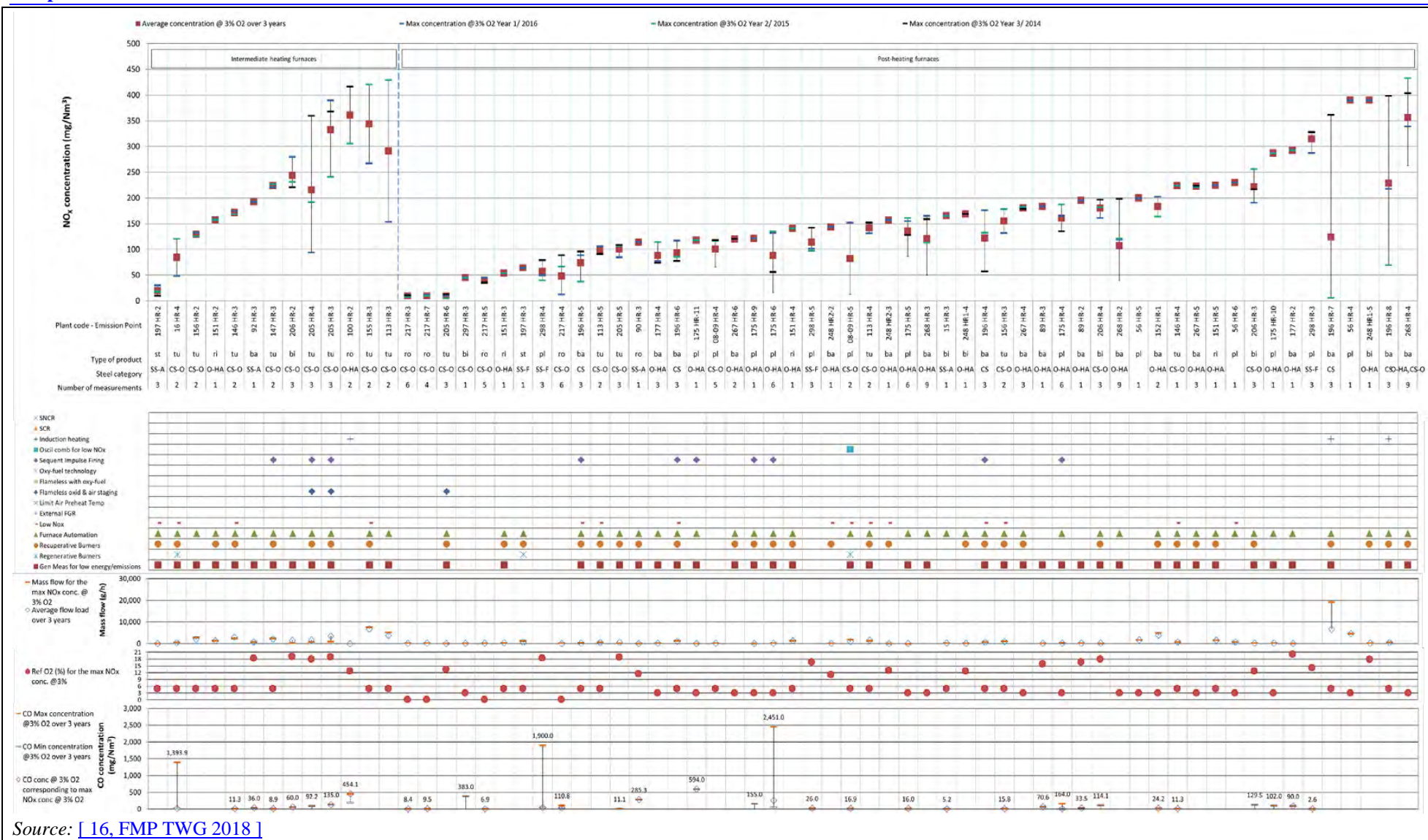


Figure 2.55: NO_x emissions from reheating (in mg/Nm³ at 3 % oxygen) for 100 % natural gas – Part 1 of 2



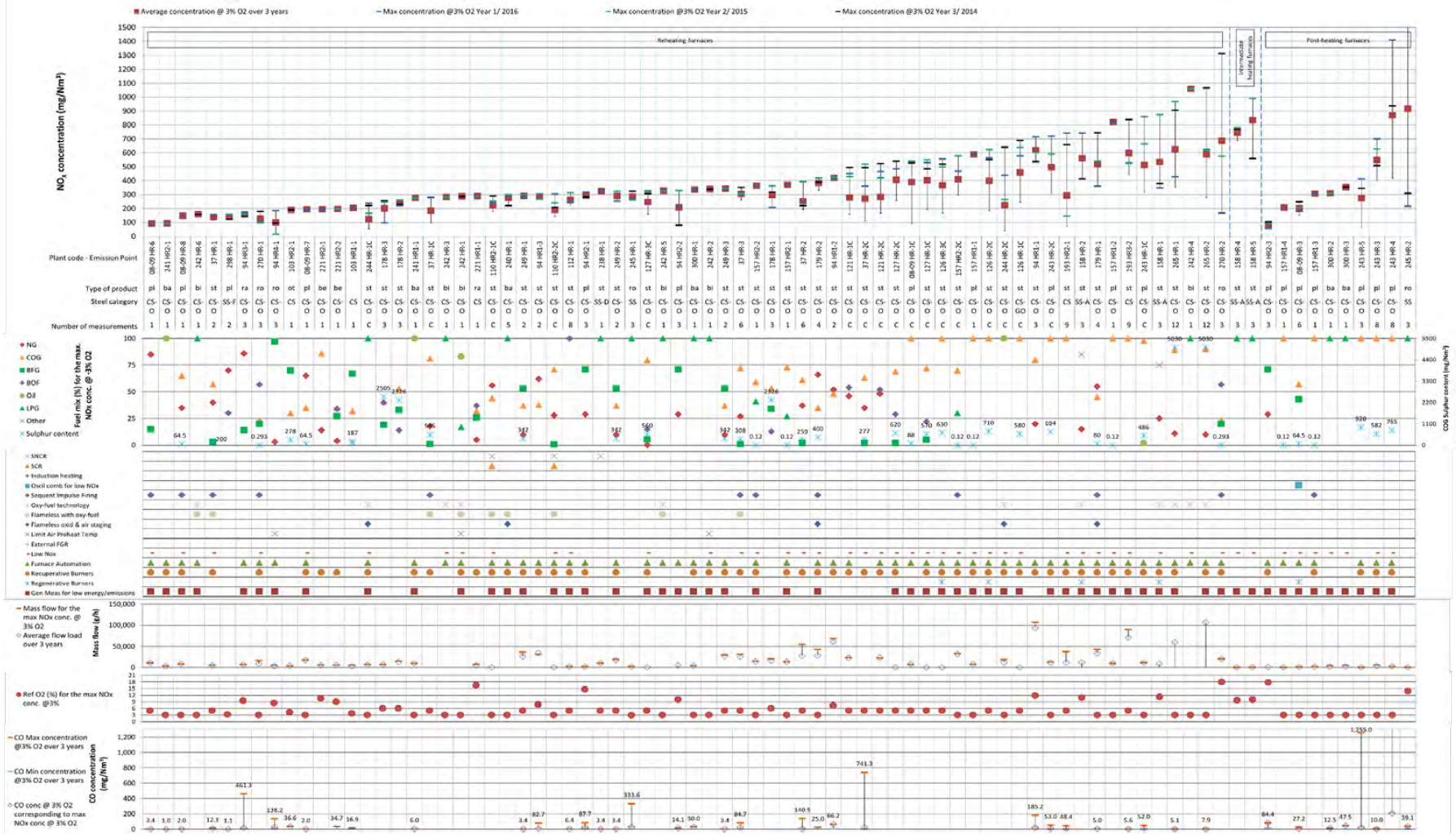
Source: [16, FMP TWG 2018]

Figure 2.56: NO_x emissions from reheating (in mg/Nm³ at 3 % oxygen) for 100 % natural gas – Part 2 of 2



Source: [16, FMP TWG 2018]

Figure 2.57: NO_x emissions from intermediate and post-heating (in mg/Nm³ at 3 % oxygen) for 100 % natural gas



Values too high for the scale of the figure:

Plant code - Emission Point	Average concentration over 3 years (mg/Nm³)	Max. concentration Year 1/2016 (mg/Nm³)	Max. concentration Year 2/2015 (mg/Nm³)	Max. concentration Year 3/2014 (mg/Nm³)	CO Max. concentration @ 3 % O ₂ over 3 years
243 HR-4					15 117
245 HR-2			2 222.5		

Source: [16, FMP TWG 2018]

Figure 2.58: NO_x emissions from reheating intermediate and post-heating (in mg/Nm³ at 3 % oxygen) for fuels other than 100 % natural gas

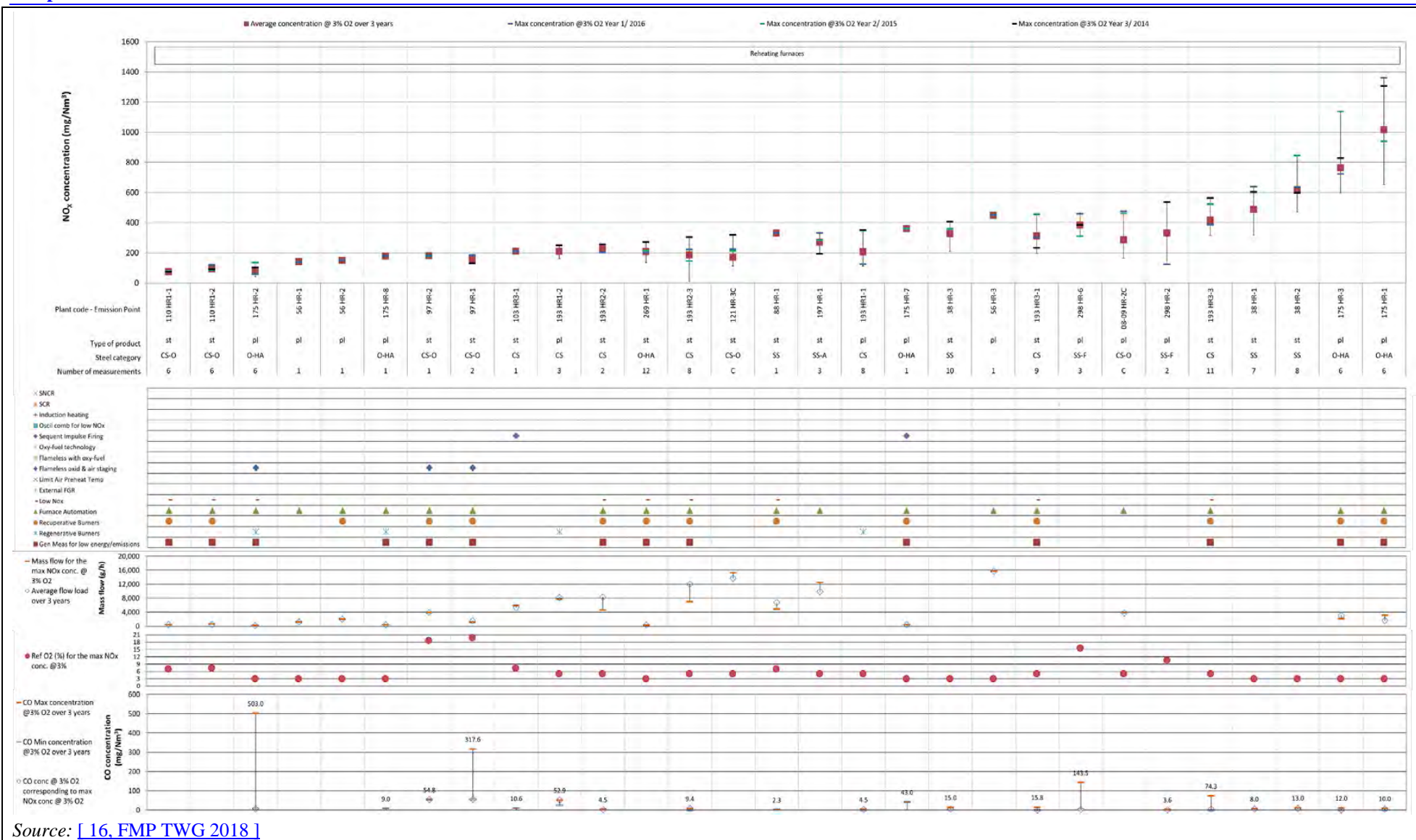
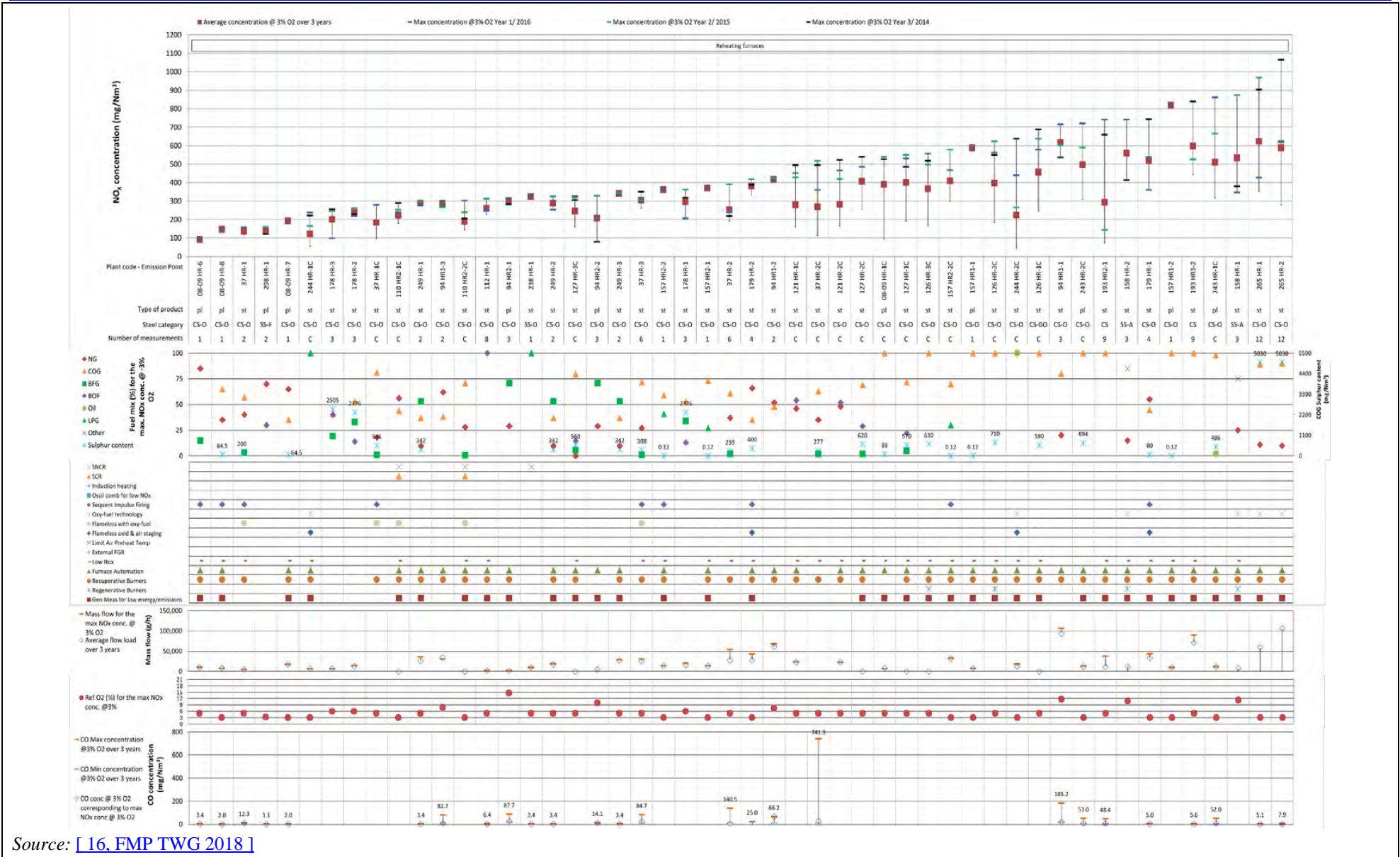


Figure 2.59: NO_x emissions from reheating (in mg/Nm³ at 3 % oxygen) for 100 % natural gas for reheating of flat products

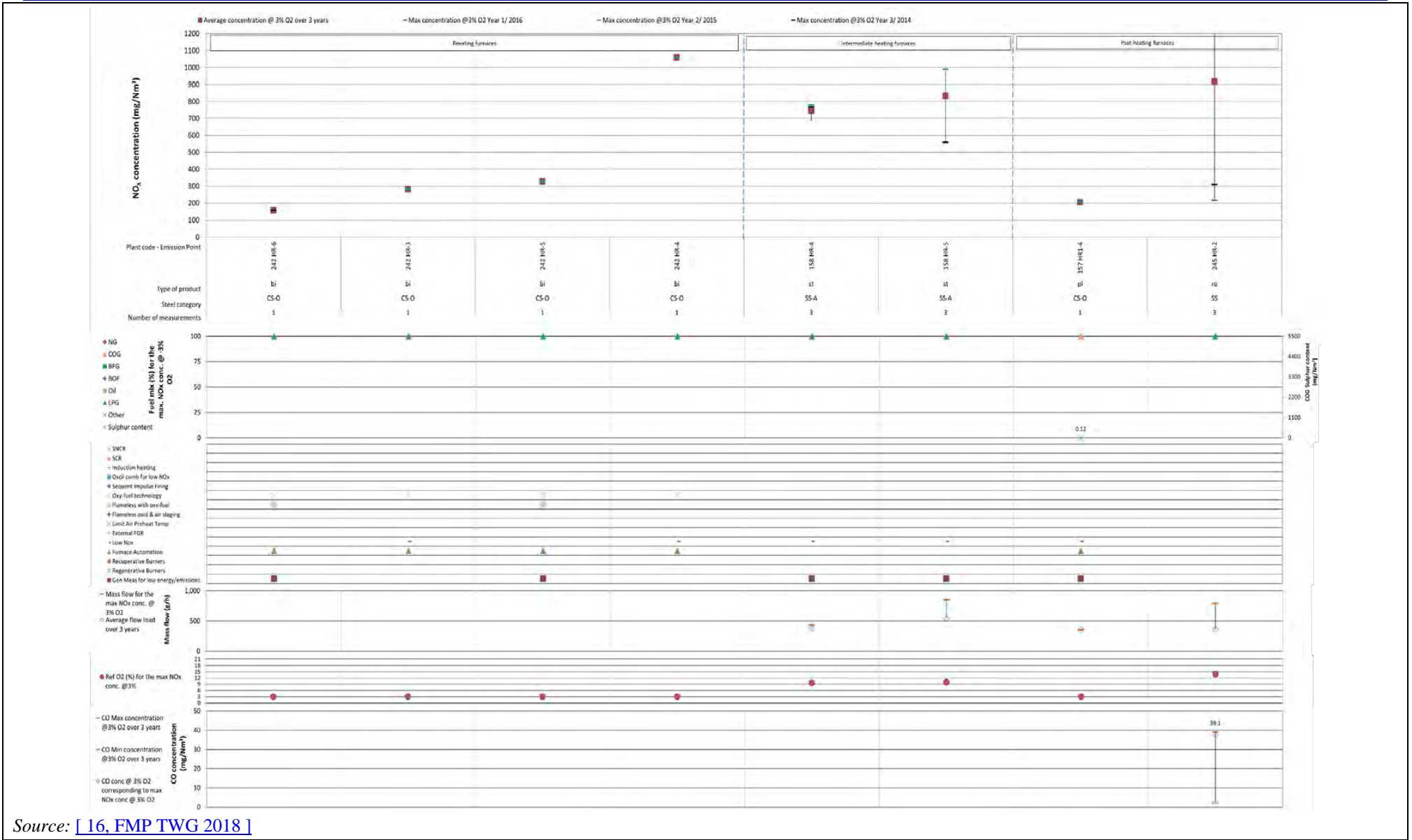


Source: [16, FMP TWG 2018]

Figure 2.60: NO_x emissions from reheating (in mg/Nm³ at 3 % oxygen) for fuels other than 100 % natural gas for reheating of flat products

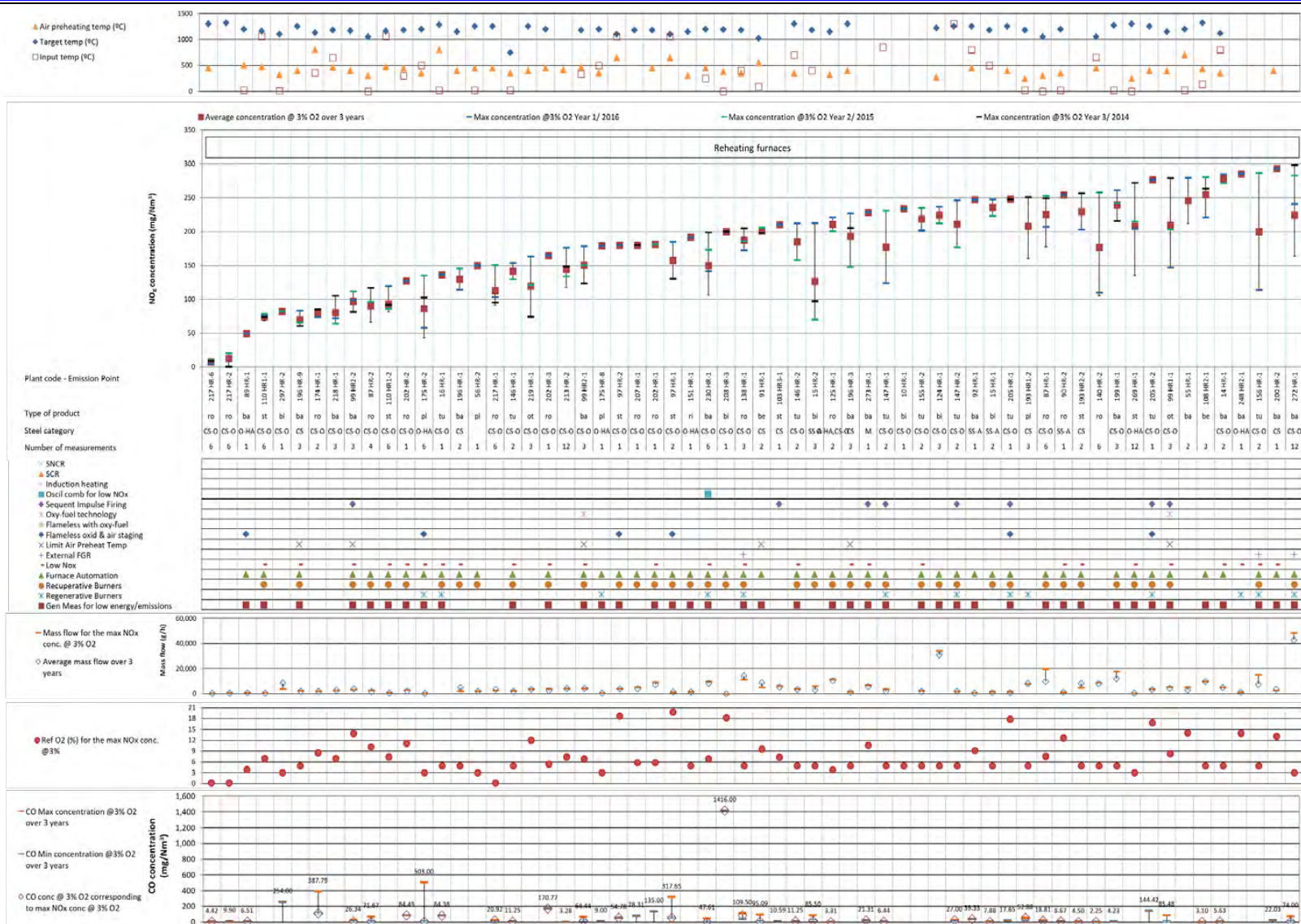


Figure 2.61: NO_x emissions from reheating, intermediate and post-heating (in mg/Nm³ at 3 % oxygen) for 100 % natural gas, without air preheating



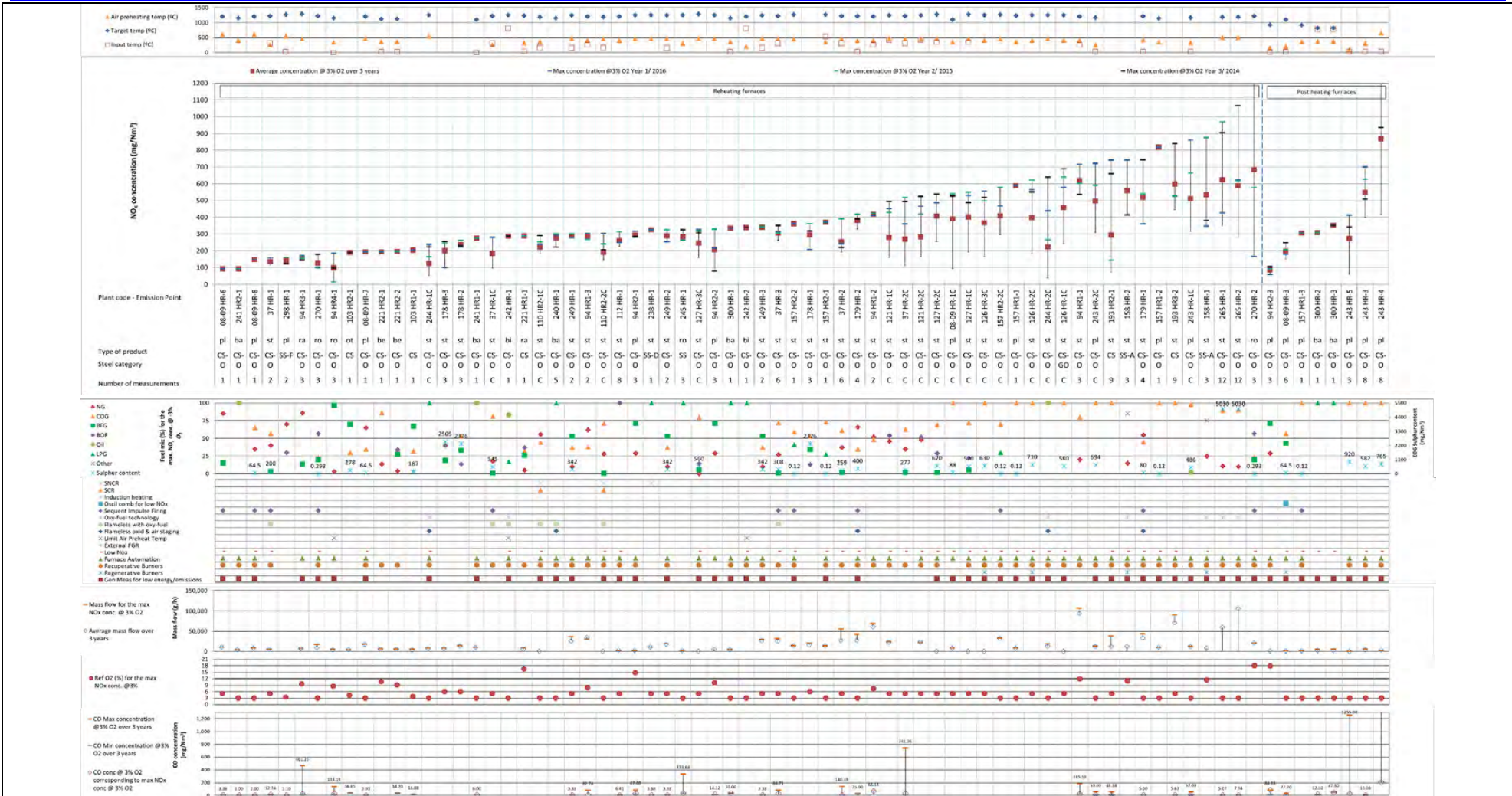
Source: [16, FMP TWG 2018]

Figure 2.62: NO_x emissions from reheating, intermediate and post-heating (in mg/Nm³ at 3 % oxygen) for fuels other than 100 % natural gas, without air preheating



Source: [16, FMP TWG 2018]

Figure 2.63: NOx emissions from reheating (in mg/Nm³ at 3 % oxygen) for 100 % natural gas, with air preheating temperature and feedstock target temperature – Part 1 of 2

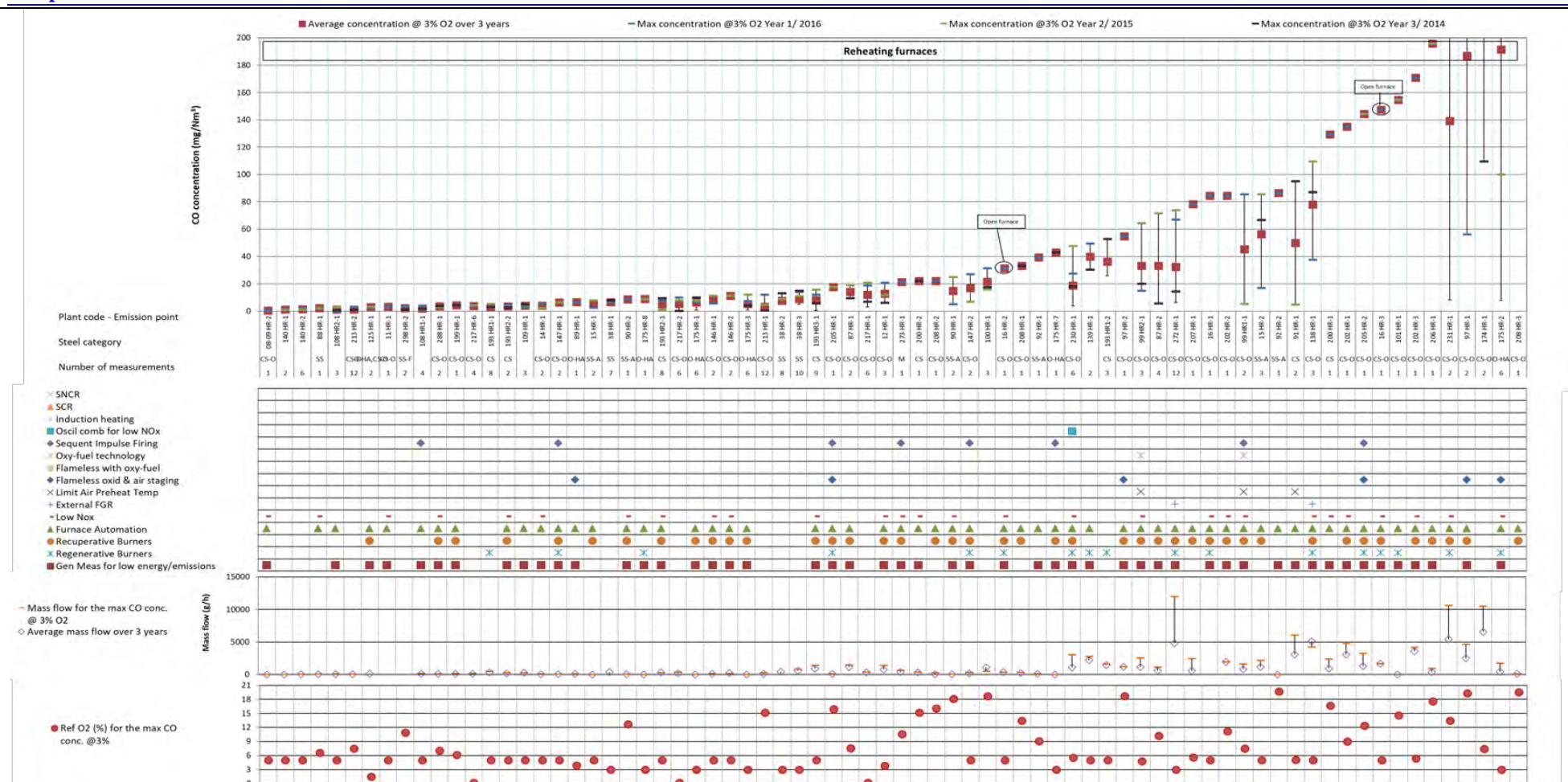


Values too high for the scale of the figure:

Plant code - Emission Point	Average concentration over 3 years (mg/Nm ³)	Max. concentration Year 1/2016 (mg/Nm ³)	Max. concentration Year 2/2015 (mg/Nm ³)	Max. concentration Year 3/2014 (mg/Nm ³)	CO Max. concentration @ 3 % O ₂ over 3 years
243 HR-4					15 117

Source: [16, FMP TWG 2018]

Figure 2.66: NO_x emissions from reheating and post-heating (in mg/Nm³ at 3 % oxygen) for fuels other than 100 % natural gas, with air preheating temperature and feedstock target temperature

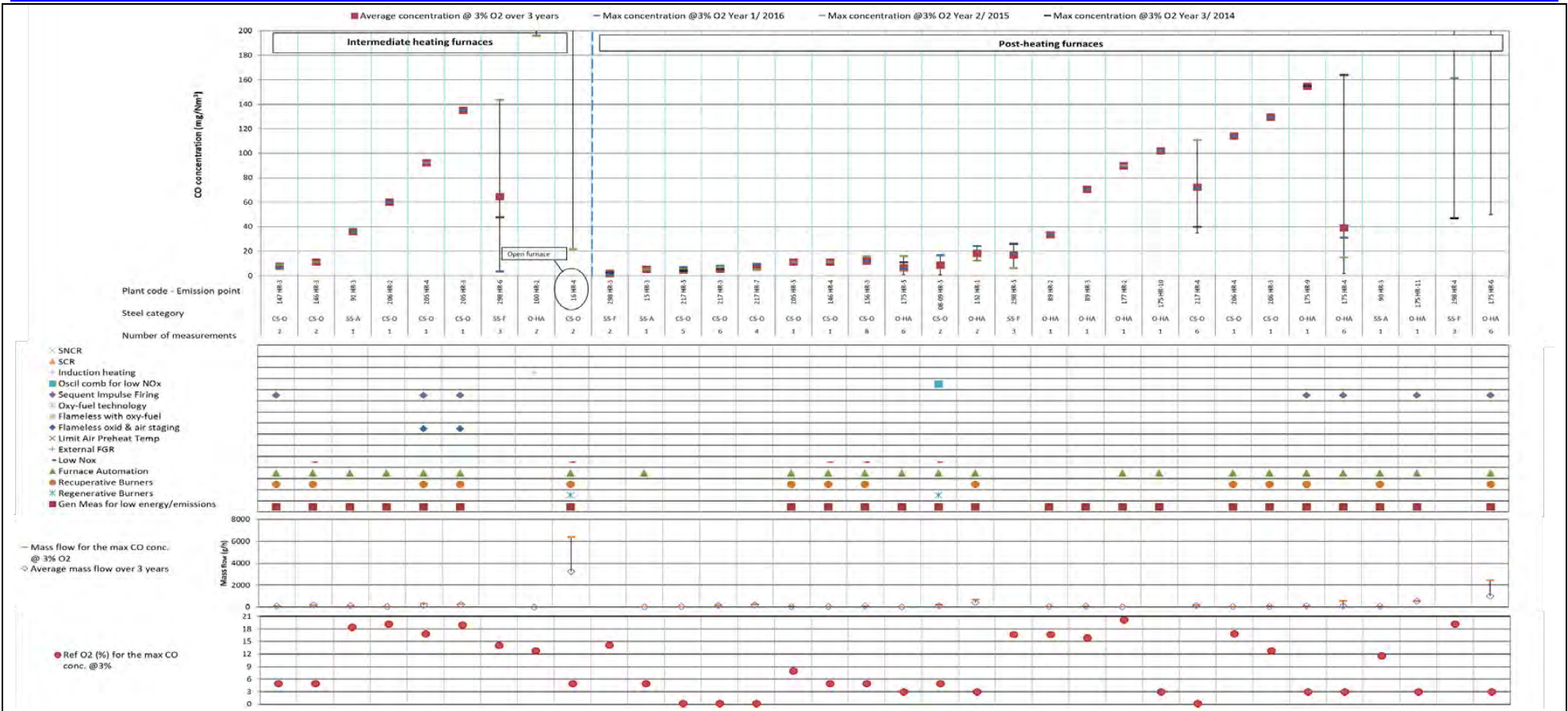


Values too high for the scale of the figure:

Plant code - Emission Point	Average concentration over 3 years (mg/Nm ³)	Max. concentration Year 1/2016 (mg/Nm ³)	Max. concentration Year 2/2015 (mg/Nm ³)	Max. concentration Year 3/2014 (mg/Nm ³)
231 HR-1			270.0	
97 HR-1	317.7			317.7
174 HR-1	248.7	387.8		
175 HR-2		484.0		503.0
208 HR-3	1 416.0			1 416.0

Source: [16, FMP TWG 2018]

Figure 2.67: CO emissions from reheating (in mg/Nm³ at 3 % oxygen) for 100 % natural gas

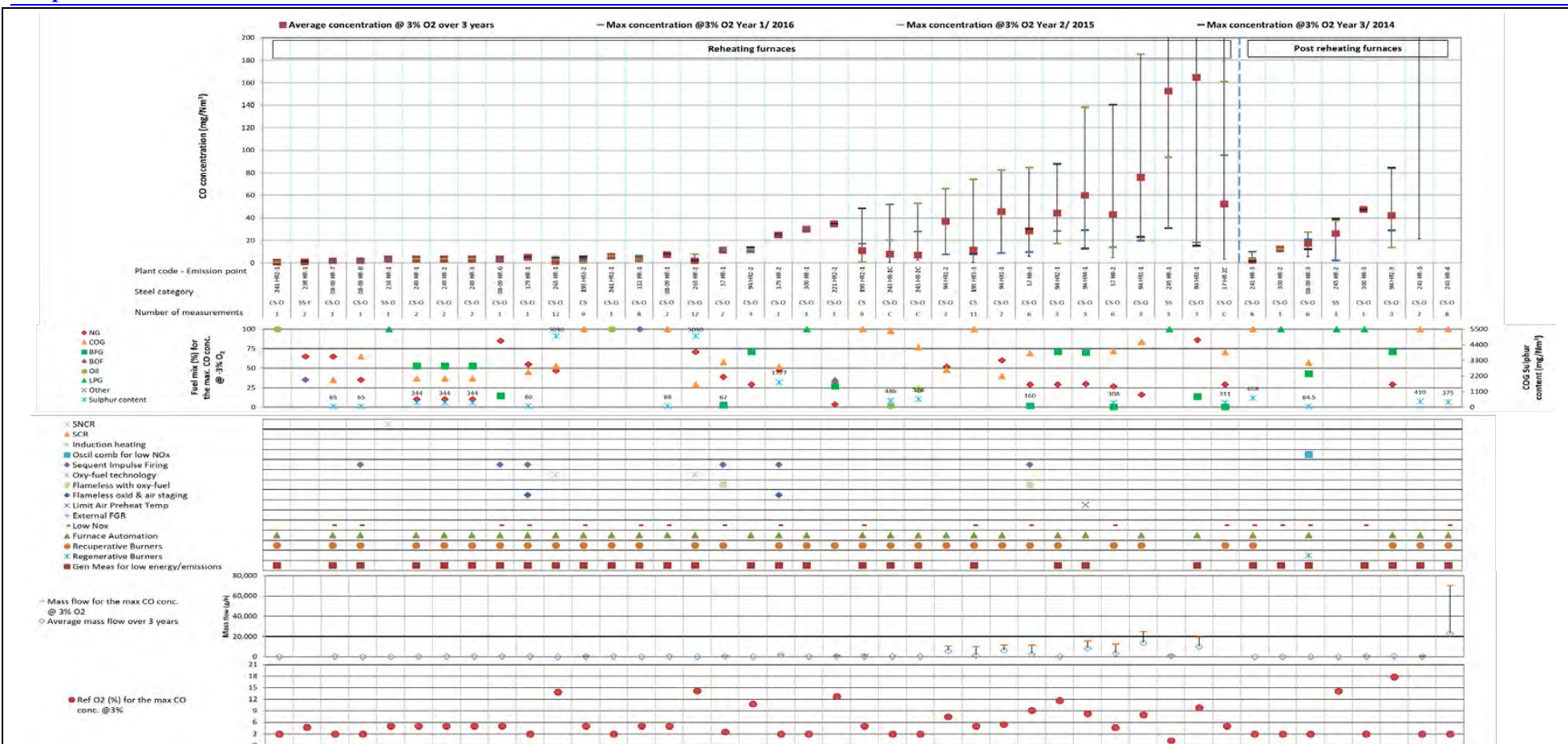


Values too high for the scale of the figure:

Plant code - Emission Point	Average concentration over 3 years (mg/Nm ³)	Max. concentration Year 1/2016 (mg/Nm ³)	Max. concentration Year 2/2015 (mg/Nm ³)	Max. concentration Year 3/2014 (mg/Nm ³)
100 HR-2	325.2			454.1
16 HR-4	707.6		1 393.9	
90 HR-3	285.3		285.3	
175 HR-11	594.0		594.0	1 416.0
298 HR-4	703.0		1,900.0	
175 HR-6	963.5	2 431.0		2 451.0

Source: [16, FMP TWG 2018]

Figure 2.68: CO emissions from intermediate and post-heating (in mg/Nm³ at 3 % oxygen) for 100 % natural gas



Values too high for the scale of the figure:

Plant code - Emission Point	Average concentration over 3 years (mg/Nm ³)	Max. concentration Year 1/2016 (mg/Nm ³)	Max. concentration Year 2/2015 (mg/Nm ³)	Max. concentration Year 3/2014 (mg/Nm ³)
245 HR-1		333.6		
94 HR3-1			461.3	
37 HR-2C				741.3
243 HR-5	638.2	1 255.0		
243 HR-4	5 286.3	8 261.3		1 5117.0

Source: [16, FMP TWG 2018]

Figure 2.69: CO emissions from reheating and post-heating (in mg/Nm³ at 3 % oxygen) for fuels other than 100 % natural gas

2.3.6 Emissions to water

All the data related to emissions to water from HR processes are presented in Section 7.2.1 of the document where figures depicting emissions to water for all sectors are presented in a merged format.

2.3.7 Residues

In total, only 5 plants reported data about the generation of oil-containing residues, and 12 plants reported data about the generation of scale. This information is summarised in Figure 2.70 and Figure 2.71, respectively. Table 2.14 below contains the information reported by four plants about the amounts of filter dust generated. The reported data are also presented in Figure 2.72. All the figures for residues show the residues generation levels for three operating years and also the yearly average obtained for each HR plant.

Table 2.14: Specific generation of filter dust (in kg/t)

Plant code	Steel product	Steel grade	Specific amount of filter dust (kg/t)				Recycle in plant	EWC code	Classification
			2016	2015	2014	Average over 3 years			
56 HR	Plates	CS-O	0.18	0.18	NI	0.18	NI	NI	NI
238 HR	Strips	SS-D	0.14	0.16	0.16	0.15	NO	10 02 08	Non-hazardous
247 HR	Plates	SS-A SS-D	4.17	4.21	4.54	4.31	NO	10 02 10	Non-hazardous
273 HR	Bars	CS-O O-HA	0.40	0.40	0.37	0.39	YES	10 02 08	Non-hazardous

NI = No information.
CS-O = CS-other (non-alloy/low-alloy).
SS-A = SS-Austenitic.
SS-D = SS-Duplex.
Source: [16, FMP TWG 2018]

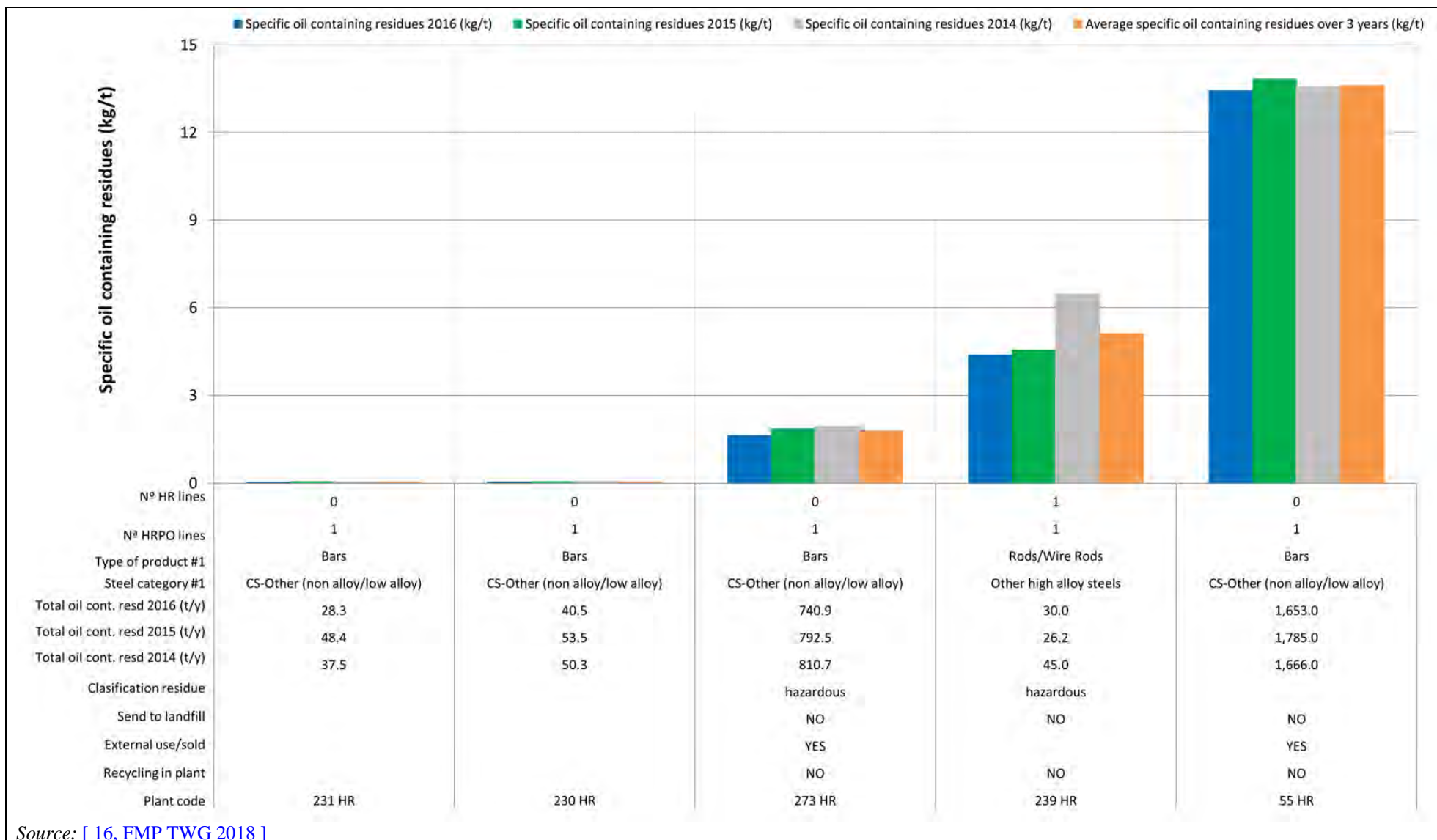


Figure 2.70: Specific generation of oil-containing residues (in kg/t)

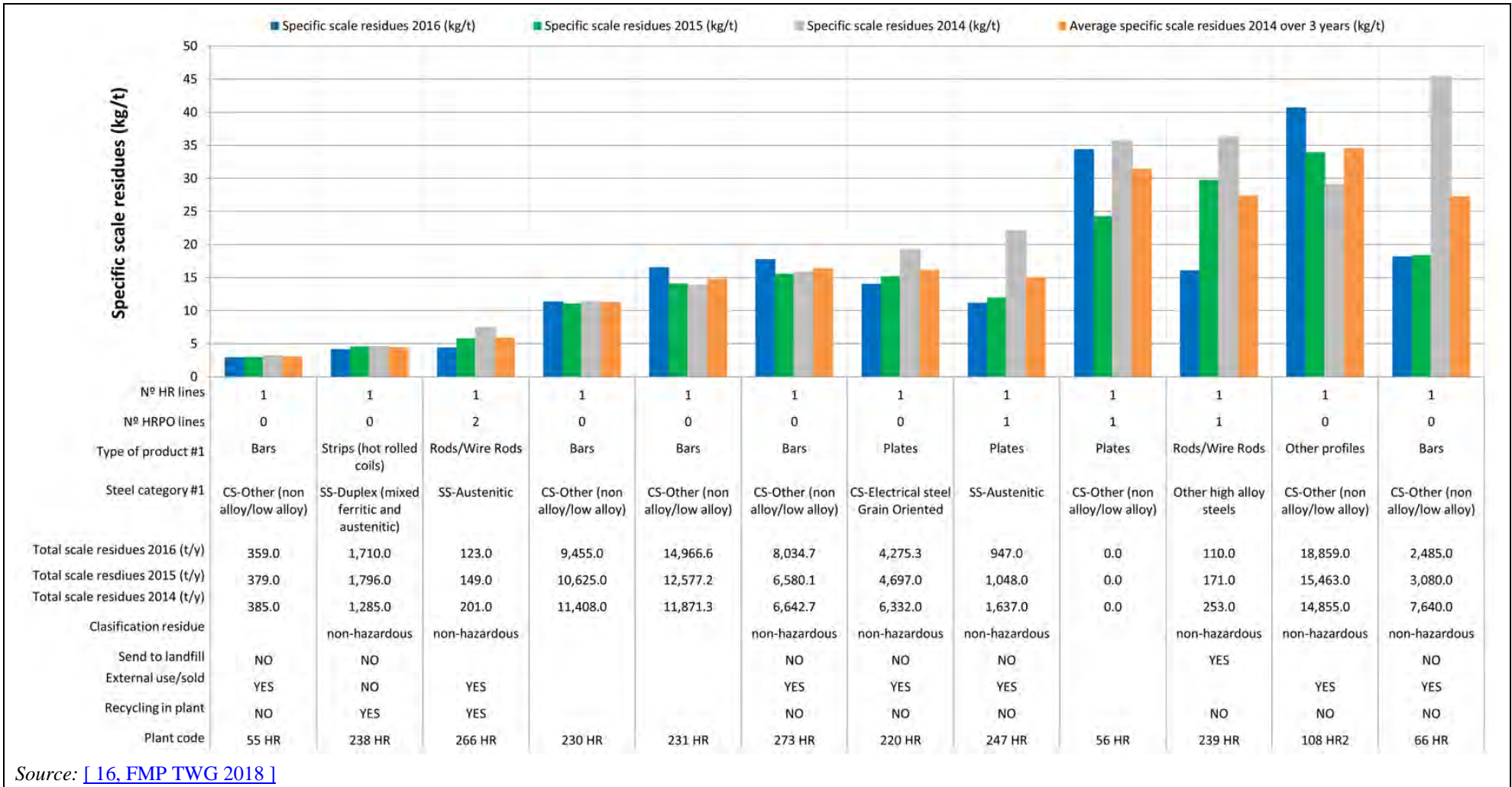
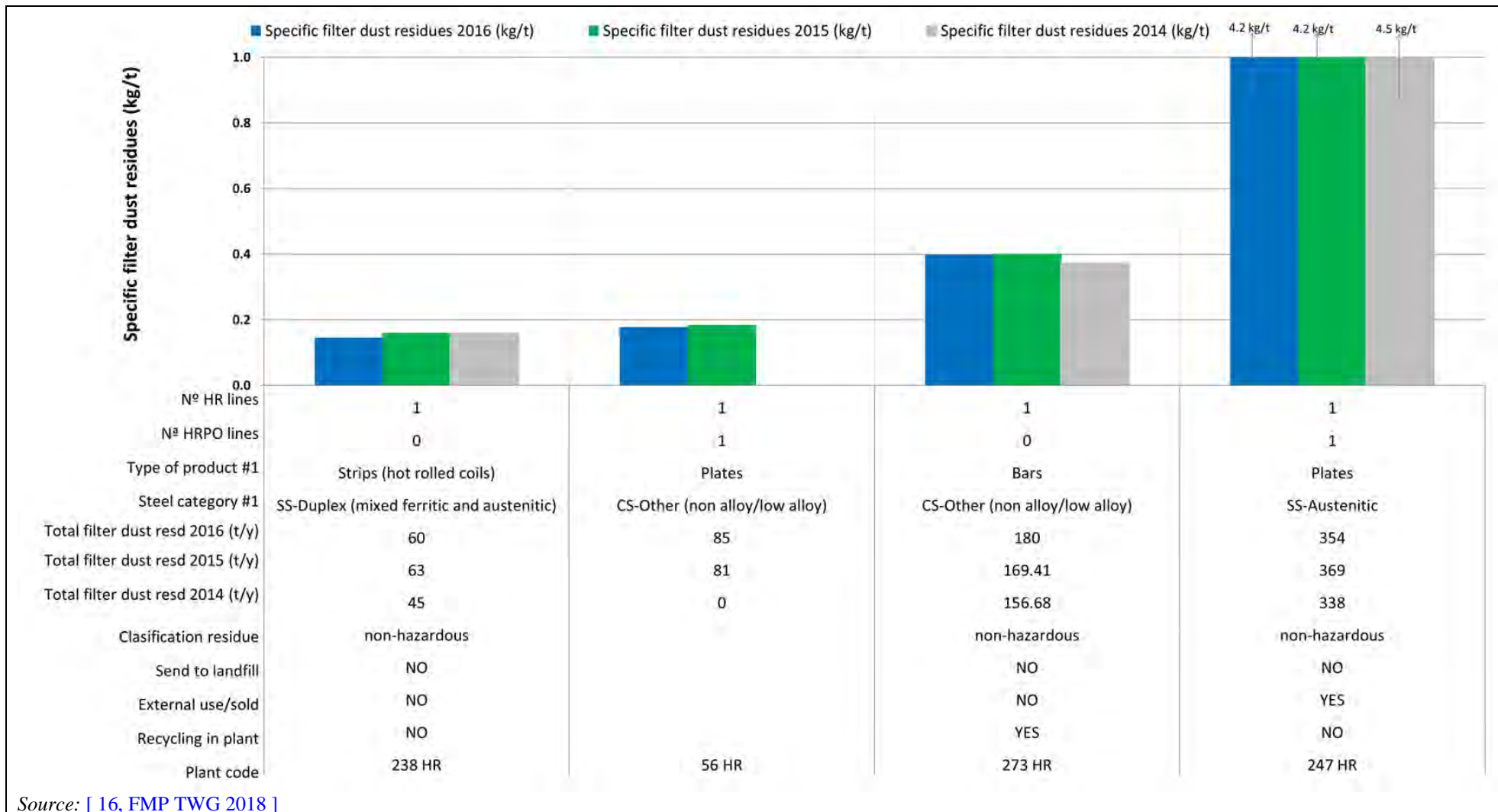


Figure 2.71: Specific generation of scale (in kg/t)



Source: [16, FMP TWG 2018]

Figure 2.72: Specific generation of filter dust (in kg/t)

2.4 Techniques to consider in the determination of BAT for hot rolling

This section describes techniques (or combinations thereof), and associated monitoring, considered to have the potential for achieving a high level of environmental protection in the activities within the scope of this document. The techniques described will include both the technology used and the way in which the installations are designed, built, maintained, operated and decommissioned.

It covers environmental management systems as well as process-integrated and end-of-pipe techniques. Waste prevention and management, including waste minimisation and recycling procedures, are also considered, as well as techniques that reduce the consumption of raw materials, water and energy by optimising use and reuse. The techniques described also cover the prevention or limiting of the environmental consequences of accidents and incidents. They also cover the prevention or reduction of emissions under other than normal operating conditions (such as start-up and shutdown operations, leaks, malfunctions, momentary stoppages and the definitive cessation of operations).

Annex III to the Directive lists a number of criteria for determining BAT, and the information within this chapter will address these considerations. As far as possible, the standard structure in Table 2.15 is used to outline the information on each technique, to enable a comparison of techniques and the assessment against the definition of BAT in the Directive.

This chapter does not necessarily provide an exhaustive list of techniques that could be applied in the sector. Other techniques may exist, or may be developed, which could be considered in the determination of BAT for an individual installation.

Table 2.15: Information for each technique

Heading within the sections	Type of information included
Description	A brief description of the technique with a view to being used in the BAT conclusions.
Technical description	A more detailed and yet concise technical description using, as appropriate, chemical or other equations, pictures, diagrams and flow charts.
Achieved environmental benefits	The main potential environmental benefits to be gained through implementing the technique (including reduced consumption of energy; reduced emissions to water, air and land; raw material savings; as well as production yield increases, reduced waste, etc.).
Environmental performance and operational data	Actual and plant-specific performance data (including emission levels, consumption levels – of raw materials, water, energy – and amounts of residues/wastes generated) from well-performing installations/plants (with respect to the environment taken as a whole) applying the technique accompanied by the relevant contextual information. Any other useful information on the following items: <ol style="list-style-type: none"> 1. how to design, operate, maintain, control and decommission the technique; 2. emission monitoring issues related to the use of the technique; 3. sensitivity and durability of the technique; 4. issues regarding accident prevention.

	<p>Links between inputs (e.g. nature and quantity of raw material and fuel, energy, water) and outputs (emissions, residues/wastes, products) are highlighted, in particular where relevant to enhancing an understanding of different environmental impacts and their interaction, for example where trade-offs have been made between different outputs such that certain environmental performance levels cannot be achieved at the same time.</p> <p>Emission and consumption data are qualified as far as possible with details of relevant operating conditions (e.g. percentage of full capacity, fuel composition, bypassing of the (abatement) technique, inclusion or exclusion of other than normal operating conditions, reference conditions), sampling and analytical methods, and statistical presentation (e.g. short- and long-term averages, maxima, ranges and distributions).</p> <p>Information is included on conditions/circumstances hampering the use of the (abatement) technique at full capacity and/or necessitating full or partial bypassing of the (abatement) technique and measures taken to restore full (abatement) capacity.</p>
Cross-media effects	<p>Relevant negative effects on the environment due to implementing the technique, allowing a comparison between techniques in order to assess the impact on the environment as a whole. This may include issues such as:</p> <ul style="list-style-type: none"> • consumption and nature of raw materials and water; • energy consumption and contribution to climate change; • stratospheric ozone depletion potential; • photochemical ozone creation potential; • acidification resulting from emissions to air; • presence of particulate matter in ambient air (including microparticles and metals); • eutrophication of land and waters resulting from emissions to air or water; • oxygen depletion potential in water; • persistent/toxic/bioaccumulable components (including metals); • generation of residues/waste; • limitation of the ability to reuse or recycle residues/waste; • generation of noise and/or odour; • increased risk of accidents. <p>The Reference Document on Economics and Cross-media Effects (ECM) should be taken into account.</p>
Technical considerations relevant to applicability	<p>It is indicated whether the technique can be applied throughout the sector. Otherwise, the main general technical restrictions on the use of the technique within the sector are indicated. These may be:</p> <ul style="list-style-type: none"> • an indication of the type of plants or processes within the sector to which the technique cannot be applied; • constraints to implementation in certain generic cases, considering, e.g.: <ul style="list-style-type: none"> - whether it concerns a new or an existing plant, taking into

	<p>account factors involved in retrofitting (e.g. space availability) and interactions with techniques already installed;</p> <ul style="list-style-type: none"> - plant size, capacity or load factor; - quantity, type or quality of product manufactured; - type of fuel or raw material used; - animal welfare; - climatic conditions. <p>These restrictions are indicated together with the reasons for them.</p> <p>These restrictions are not meant to be a list of the possible local conditions that could affect the applicability of the technique for an individual plant.</p>
Economics	<p>Information on the costs (capital/investment, operating and maintenance costs including details on how they have been calculated/estimated) and any possible savings (e.g. reduced raw material or energy consumption, waste charges, reduced payback time compared to other techniques), or revenues or other benefits including details on how these have been calculated/estimated.</p> <p>Cost data are preferably given in euros (EUR). If a conversion is made from another currency, the data in the original currency and the year when the data were collected are indicated. The price/cost of the equipment or service is accompanied by the year it was purchased.</p> <p>Information on the market for the sector is given in order to put costs of techniques into context.</p> <p>Information relevant to both newly built, retrofitted and existing plants is included. This should allow assessment, where possible, of the economic viability of the technique for the sector concerned and possible economic limitations to its application.</p> <p>Information on the cost-effectiveness of the technique (e.g. in EUR per mass of pollutant abated) and related assumptions for its calculation can be reported.</p> <p>The Reference Document on Economics and Cross-media Effects (ECM) and the Reference Report on Monitoring of Emissions to Air and Water from IED Installations (ROM) are taken into account with regard to economic aspects and monitoring costs, respectively.</p>
Driving force for implementation	<p>Where applicable, specific local conditions, requirements (e.g. legislation, safety measures) or non-environmental triggers (e.g. increased yield, improved product quality, economic incentives – e.g. subsidies, tax breaks) which have driven or stimulated the implementation of the technique to date are provided.</p> <p>This subsection should be very short and use a list of bullet points.</p>
Example plants	<p>Reference to a plant(s) where the technique has been implemented and from which information has been collected and used in writing the section. An indication of the degree to which the technique is in use in the EU or worldwide.</p>
Reference literature	<p>Literature or other reference material (e.g. books, reports, studies) that was used in writing the section and that contains more detailed information on the technique. When the reference material consists of many pages, reference will be made to the relevant page(s) or section(s).</p>

In Chapter 8 general techniques used in more than one sector are discussed which might also be applicable to hot rolling. These techniques are normally not repeated in this section, unless information specific for this sector was made available.

2.4.1 Surface rectification and conditioning of input

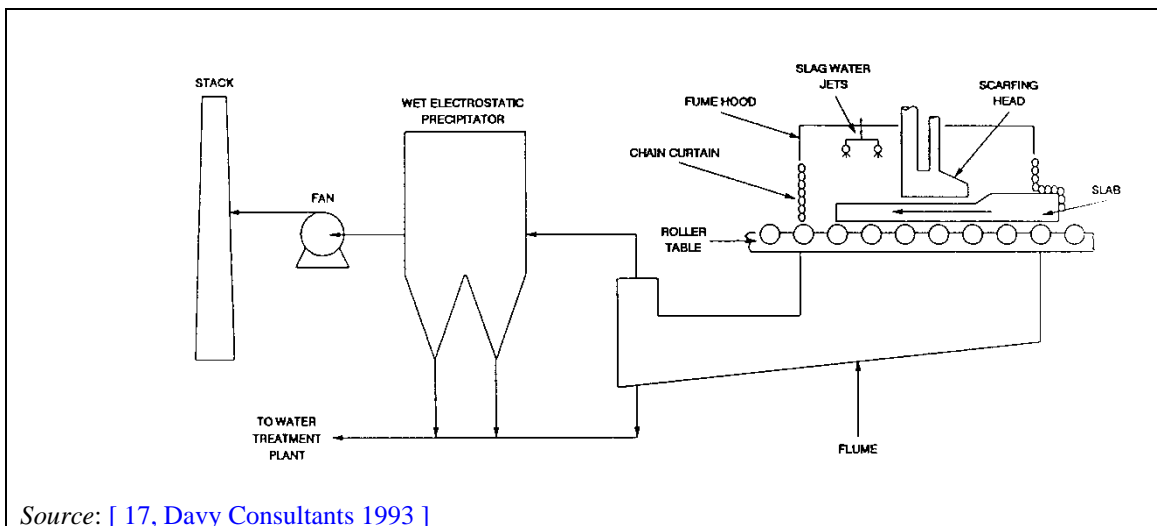
2.4.1.1 Enclosed scarfing (other than manual scarfing) combined with air extraction and waste gas treatment

Description

Scarfing operations (other than manual scarfing) are carried out completely enclosed (e.g. under closed hoods) and air is extracted. The waste gases are treated using electrostatic precipitators (dry or wet) or fabric filters.

Technical description

As shown in Figure 2.73, scarfing takes place in a tightly closed hood, which captures the fume and dust generated by the oxy-fuel flame. The waste air is cleaned by **dry** or **wet electrostatic precipitators** or **fabric filters**. The collected dust is internally recycled within integrated steelworks or disposed of by authorised companies. Water jets are used to remove the slag from the conditioned surface. Spent water and slag are collected in a flume beneath the roller table and transferred to water treatment.



Source: [17, Davy Consultants 1993]

Figure 2.73: Scarfing abatement flowsheet (example with wet EP)

Achieved environmental benefits

Reduced dust emissions to air.

Environmental performance and operational data

ArcelorMittal Ghent

The scarfing machine is located in a special building (dimensions 32 m x 18 m x 9 m) with acoustic insulated sidewalls leading to a maximum noise level of 85 dB(A) at 1 m. The fume is captured at the four corners of the roof. The whole installation is operated under suction with an aspiration flow of 200 000 m³/h. The aspiration is controlled automatically as a function of the place where the scarfing takes place (two thirds of fumes are aspired above the work area). The exhaust air is cleaned by fabric filters with filter area of 3 576 m², leading to an exit dust concentration of 5–10 mg/Nm³ (continuous optical measurement in stack).

Liberty Speciality Steels UK

The scarfing machine is situated inside the billet mill and is housed under a hood with extraction towards a wet ESP (as described in Figure 2.73). The hood prevents fugitive emissions of dust and is also equipped with water sprays. Chain curtains situated at the inlet and outlet of the hood contain the water sprayed in the hood as much as possible. Dust emissions are typically within the range 5–10 mg/m³. [25, EUROFER 2018]

As the fume generated by scarfing is very corrosive, maintenance is an important issue for good performance of the abatement units. Regular inspection of the electrostatic precipitator electrodes and associated internal parts is recommended to survey corrosion. If the fume is very wet, the use of bag filters can be problematic. [26, Hot Rolling Shadow Group 1999]

Table 2.16: Achievable emission levels for dust emissions from scarfing / grinding operation

Applied abatement technique	Concentrations reported over 3-year period - (mg/Nm ³)					Number of measurements
	Average	Median	90 th percentile	Min.	Max.	
Fabric filter	3.9	2.2	6.3	0.08	46.8	43
Wet ESP	30.5	21	57.6	3.7	66.8	3
Wet ESP + dry ESP	7.7	-	-	4.7	10.7	2
Wet ESP + fabric filter	3.6	-	-	1.8	5.3	2

Source: [16, FMP TWG 2018]

Cross-media effects

- Increased energy consumption.
- Generation of waste / filter dust or sludge which is collected.
- Generated waste can be reduced by internal recycling.

Technical considerations relevant to applicability

- Generally, there are no technical restrictions to the applicability of this technique.
- Not applicable to manual scarfing.

Economics

No information provided.

Driving force for implementation

Prevention of fugitive emissions. [26, Hot Rolling Shadow Group 1999]

Example plants

ArcelorMittal Ghent, ArcelorMittal Aviles, Liberty Speciality Steels UK.

Plants from the data collection: 121 HR, 172 HR, 179 HR, 249 HR and 265 HR.

Reference literature

[16, FMP TWG 2018], [25, EUROFER 2018], [26, Hot Rolling Shadow Group 1999].

2.4.1.2 Enclosed grinding combined with air extraction and waste gas treatment

Description

Grinding operations are carried out completely enclosed (e.g. under closed hoods) and air is extracted and treated using fabric filters.

Technical description

The grinding machine is used for surface rectification of slabs. The dust created by grinding operations is collected and precipitated in a fabric filter (Figure 2.74). Machine grinding may be carried out in soundproofed enclosures. The abatement unit is either stand-alone or shop-based. The collected dust is internally recycled within integrated steelworks or disposed of by authorised companies. Grinding chips are collected separately and can be directly recycled as scrap in the BOF plant. [25, EUROFER 2018]

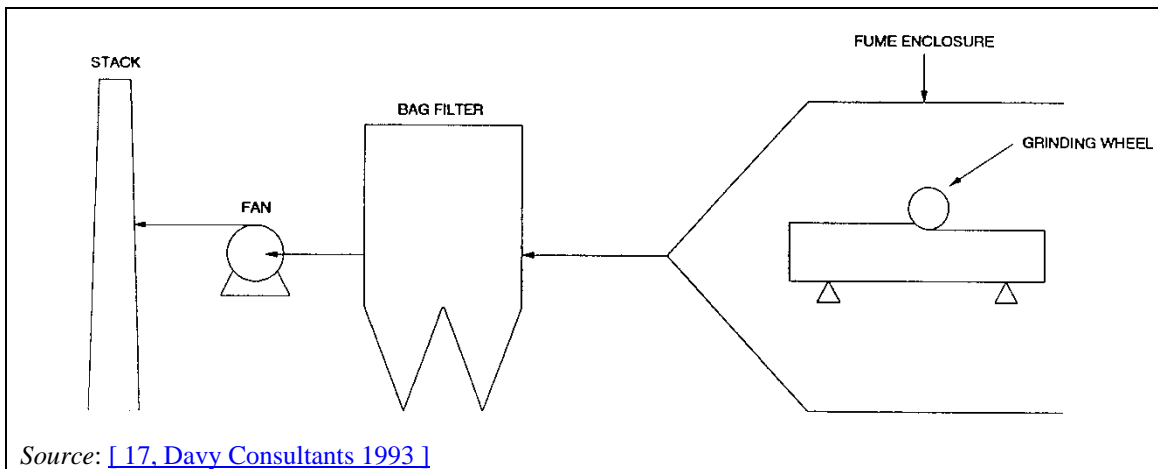


Figure 2.74: Grinding abatement flowsheet

Figure 2.75 depicts a typical grinding machine at a Tata Steel mill composed of a grinding stone, suction hood and a fabric filter. Such installation enables the removal of 2–5 mm of the surface of the slab. [25, EUROFER 2018]



Figure 2.75: Grinding machine equipped with waste gas cleaning abatement system at Tata Steel IJmuiden

Achieved environmental benefits

- Reduced dust emission to air.
- Noise is reduced.

Environmental performance and operational data

Achievable dust emission concentrations from enclosed scarfing and grinding are presented in Table 2.16.

Tata Steel IJmuiden

The grinding machine is a stand-alone machine installed in 2013 and situated in an open building. The machine is equipped with insulation material to reduce noise emissions. For noise reduction, additional control measures are taken such as encasing of the machine and wall insulation. The grinding machine has an exhaust system with a fabric filter. The flow of the exhaust waste gas cleaning system is 12 000 Nm³/h. The dust emission level is < 1 mg/Nm³. Grinding chips (around 98 % iron content) are recycled at the BOS plant whereas dust is recycled in the sinter plant. [\[25, EUROFER 2018 \]](#)

SSAB Oxelösund

The grinding machine used for surface rectification of the slabs is equipped with fabric filters and the flow of the waste gas cleaning system is 60 000 m³/h. After waste gas cleaning, the dust emission level at the outlet stack is < 2 mg/Nm³. Dust emissions are measured using a triboelectric dust monitor. The captured dust and grinding chips are recycled back to the blast furnace for briquetting. [\[25, EUROFER 2018 \]](#)

Cross-media effects

- Increased energy consumption.
- Generation of waste / filter dust which is collected.
- Waste can be reduced by internal recycling.
- Generation of grinding chips and filter dust which is collected and recycled.

Technical considerations relevant to applicability

Generally, there are no technical restrictions to the applicability of this technique.

Economics

No information provided.

Driving force for implementation

- Prevention of fugitive emissions. [\[26, Hot Rolling Shadow Group 1999 \]](#)
- Improvement of the quality of the slabs.
- Cost reduction at surface slab conditioning plants.

Example plants

- Tata Steel IJmuiden.
- Acerinox Europa.
- SSAB Oxelösund.
- Plants from the data collection: 124 HR, 158 HR, 175 HR, 177 HR, 197 HR, 243 HR, 247 HR, 248 HR1, 300 HR.

Reference literature

[\[16, FMP TWG 2018 \]](#), [\[25, EUROFER 2018 \]](#), [\[26, Hot Rolling Shadow Group 1999 \]](#).

2.4.1.3 Computer-aided quality control (CAQC)

Description

The quality of slabs is controlled by a computer which allows the adjustment of the casting conditions to minimise surface defects and enables manual scarfing of the damaged area(s) only rather than scarfing of the entire slab.

Technical description

Computer-aided quality control is used to enhance the quality of the continuous casting output and reduce surface defects in the rolled product. This is achieved using a computer model that observes and controls the casting conditions based on various peripheral measurements. Each change in the operation parameters leads to a new pre-setting of the machine for an optimised casting process. Changes in the casting conditions, which cannot be corrected by the control loop and may lead to surface defects, are recognised and visualised by the system so that the location of a possible fault is pinpointed. Subsequently, selective (manual) scarfing of the damaged areas is possible instead of automatically scarfing the entire slab.

Achieved environmental benefits

- Reduction of emissions to air and of waste from scarfing, because selective scarfing is possible.
- Energy consumption for the scarfing process is reduced.
- Enhanced surface quality.
- Reduction of scrap.

Environmental performance and operational data

Table 2.17 compares the operational data concerning the number and types of scarfing operations required at two slab casting facilities equipped with and without CAQC.

Table 2.17: Comparison of amount of scarfing with and without CAQC

	Without CAQC	With CAQC
Machine scarfed	32 %	9 %
Inspection and selective scarfing	68 %	8 %
No inspection no scarfing	NI	83 %
NB: NI = No information provided. Source: [10, Rentz et al. 1998]		

Cross-media effects

No information provided.

Technical considerations relevant to applicability

Only applicable to plants with continuous casting.

Economics

Only very limited data on economics were reported.

One source reported investment costs of EUR 4 million (1999 data) [27, Van Roosbroeck 1999], while another reported savings of USD 5 per tonne of steel (1999 data) [28, AT, TWG member 1999] in connection with the implementation of CAQC.

Driving force for implementation

- Improved quality of hot rolled product and increased yield.
- Reduction of slab conditioning costs. [28, AT, TWG member 1999]

Example plants

- VA Stahl Linz, Austria.
- ArcelorMittal Eisenhüttenstadt, Germany.
- Plants from the data collection: 121 HR, 172 HR.

Reference literature

[16, FMP TWG 2018], [26, Hot Rolling Shadow Group 1999], [27, Van Roosbroeck 1999], [28, AT, TWG member 1999].

2.4.1.4 Edging or trimming of wedge-type slabs**Description**

Wedge-type slabs are rolled under special settings where the wedge is eliminated by edging (e.g. using automatic width control or a sizing press) or by trimming.

Technical description

Instead of flame cutting, wedge-type slabs are rolled under special settings of the hot rolling mill. The wedge is either eliminated by edging technology (automatic width control or sizing press) or by trimming during the subsequent shearing of hot strips.

Achieved environmental benefits

Emissions and wastes normally generated by flame cutting are avoided.

Environmental performance and operational data

No information provided.

Cross-media effects

No information provided.

Technical considerations relevant to applicability

May not be applicable for slabs produced from ingots.
Only applicable to new plants and major plant upgrades.

Economics

No information provided.

Driving force for implementation

No information provided.

Example plants

Plants 37, 106 and 197 apply this technique. [16, FMP TWG 2018]

Reference literature

[16, FMP TWG 2018]

2.4.1.5 Slab slitting**Description**

The slabs (often cast in multiple widths) are slit before hot rolling by means of slitting devices, slit rolling or torches either manually operated or mounted on a machine .

Technical description

In the past, slab slitting was usually applied in order to increase the productivity of continuous casting. For narrow final strips, the practice was to cast in double width because the productivity of the caster was more or less double (although not exactly double, because, for quality reasons, it was sometimes necessary to reduce the casting speed for wider products in continuous casting). The process of continuous casting has made significant progress with a significant increase in the average casting speeds, leading in most cases to the suppression of multiple-width casting. However, another example of slab slitting is to reallocate some slabs on a new final order, in two specific cases: either the slabs have been produced in excess in a specific

width, and the only way to reallocate these slabs is to find a final order at a narrower width, or the slabs have been declassified for quality reasons, and the only way to reallocate them is to find a final order at a narrower width. This practice of slab slitting for reallocation leads to a material efficiency increase because if it is not possible to reallocate such slabs, they are cut into small pieces and directly recycled into the converter of the steel plant (BOF plant). Slitting itself can be either realised on a slab-slitting machine or manually operated. There is also the possibility to process the same product at double width the same time at the caster and on the hot strip mill. In this particular case (relatively rare), the slitting is achieved after the hot rolling, when one mother and wide coil becomes two children and narrow coils.

With regard to the ingot route, the practice of casting in multiple widths does not exist. The opportunity of slab slitting remains very limited because there is only the possibility to adjust the final targeted width when transforming the ingot into slab in a slabbing mill which is a preferred option in terms of material efficiency. [\[29, EUROFER 2021 \]](#)

Achieved environmental benefits

Emissions and waste arising from wedge correction are prevented.

Environmental performance and operational data

Operational data for the slabs slitting technique are given below:

- Gas consumption: 1.6 Nm³/t slab;
- Oxygen consumption: 2.7 Nm³/t slab;
- Yield loss: 1.4–3.0 % of slab weight, depending on slab dimensions. [\[28, AT, TWG member 1999 \]](#)

Cross-media effects

Additional energy consumption. [\[28, AT, TWG member 1999 \]](#)

Technical considerations relevant to applicability

May not be applicable for slabs produced from ingots.

Economics

No information provided.

Driving force for implementation

Higher caster capacity as in twin or triple casting. [\[28, AT, TWG member 1999 \]](#)

Example plants

Plants from the data collection: 121 HR, 172 HR, 173 HR, 247 HR.

Reference literature

[\[16, FMP TWG 2018 \]](#), [\[28, AT, TWG member 1999 \]](#), [\[29, EUROFER 2021 \]](#).

2.4.2 Reheating and heat treatment furnaces

2.4.2.1 Process gas management system

Description

A process gas management system enables iron and steel process gases and/or CO-rich gas from ferrochromium production to be directed to the reheating and/or heat treatment furnaces, depending on their availability. Iron and steel process gases with a low average dust and ash content and a low average sulphur content and low NO_x formation potential are selected.

Technical description

Process gas management system:

In the case of an integrated steelworks, a process gas management system enables iron and steel gases and/or CO-rich gas from ferrochromium production to be directed to the reheating and/or heat treatment furnaces in order to optimise the beneficial use of these gases.

The objectives are prioritised as:

1. internal use of the heating potential of the gases in steel production processes;
2. minimisation of use of natural gas and other fuels as auxiliary fuel(s) in the enrichment of process gases, and as fuels combusted alone;
3. sensible use of the gases in the production of steam and/or electricity, so energy is not wasted by flaring;
4. minimisation of fuel gas use through process-integrated techniques;
5. avoidance of imported electricity.

Iron and steel process gases

The three main process gases in the iron and steel industry (e.g. COG, BFG and BOF gas) have different chemical compositions and characteristics (e.g. calorific value) and are consumed throughout the works for many purposes, depending on the gas properties and availability in terms of production and location within a site. Additional information concerning the chemical compositions and characteristics of these three process gases and their use within an integrated steelworks can be found in the LCP BREF (Section 7.3). [[23, Lecomte et al. 2017](#)]

These process gases may be mixed before supply to reheating and heat treatment furnaces to balance out some of the variations and to enrich blast furnace gas to improve the calorific value. The process gases may be also supplemented with auxiliary fuels (e.g. natural gas or liquid fuels) to ensure continuity of supply. [[30, AT 31-5-17 2017](#)]

The quality (calorific value and composition) and volume of the different gases vary significantly and these factors have an impact on where the fuels can be efficiently used. The primary aim of energy management in the steel industry is the efficient distribution and use of the process gases. Local conditions (layout of the plant) can further facilitate this task. Given the different configurations of the integrated steelworks, each site defines its energy management system as is best suited for the whole site. [[31, EUROFER 10-7-18 2018](#)]

When iron and steel process gases are used alone or in combination with auxiliary gases (e.g. natural gas, LPG) in the FMP reheating and heat treatment furnaces, the gases are treated to ensure they exhibit a low average dust and ash content and a low average sulphur content.

The processes employed in the preparation of the iron and steel process gases prior to their use are briefly summarised below and can be found also in the IS BREF. [[22, COM 2013](#)]

- COG

Sulphur contained in coke oven gas is a major source of SO₂ emissions from heating and reheating furnaces. According to the BAT conclusions of the IS BREF [[22, COM 2013](#)], BAT is to reduce the sulphur content of the COG by desulphurisation using the following techniques:

1. desulphurisation by absorption systems;
2. wet oxidative desulphurisation.

The residual hydrogen sulphide (H₂S) concentrations associated with BAT, determined as daily mean averages, are < 300–1 000 mg/Nm³ in the case of using technique 1 above (the higher values being associated with higher ambient temperatures and the lower values being associated with lower ambient temperatures) and < 10 mg/Nm³ in the case of using technique 2 above. (BAT 48 in [[22, COM 2013](#)]).

Integrated steelworks in Europe employ, as a minimum requirement, technique I for COG desulphurisation and should strive towards implementing technique II to achieve the best environmental performance. In the case of COG, ‘low sulphur content’ implicitly means that the COG supplied to the FMP plant has been desulphurised according to BAT 48 of the IS BREF, preferably using technique II. Desulphurised COG is not considered a low sulphur fuel, however it can be used as a fuel as long as the emissions from the FMP plants are within the BAT-AEL range specified in the BAT conclusions. [[32, Pre-FD comments 2021](#)]

- BF and BOF gas

BF and BOF gas contain low concentrations of sulphur. However, cleaning of these gases is carried out to reduce dust emissions. By applying BAT for BF and BOF gas cleaning, levels < 10 mg dust/Nm³ can be achieved for BF gas and < 10–30 mg dust/Nm³ for BOF gas using dry dedusting (e.g. electrostatic precipitator) techniques for new and existing plants or < 50 mg dust/Nm³ using wet dedusting techniques (e.g. wet electrostatic precipitator or scrubber) for existing plants. (BAT 75 in [[22, COM 2013](#)])

- CO-rich gas from ferrochromium production

Ferrochromium is produced from chromite ore and iron in a closed submerged arc furnace or in a closed plasma dust process. These processes are described in more detail in the NFM BREF (see Section 8.1.1). Exhaust gases from a closed submerged arc furnace are usually cleaned using a wet venturi scrubber where the particulate emissions are reduced from 35–45 g/m³ down to 50–100 mg/Nm³. The remaining particulate matter is further removed using a sintered filter leaving less than 1 mg/Nm³ in the cleaned exhaust gases. The resulting gas is rich in carbon monoxide and the ‘CO-rich gas’ formed in a closed submerged arc furnace contains about 75–90 % CO, 2–15 % H₂, 2–10 % CO₂, 2–5 % N₂ and < 5 % H₂O [[33, Niemela et al. 2004](#)]. When burning this gas, the heating value of the CO-rich gas is about 243 GJ/h [[33, Niemela et al. 2004](#)], and therefore there is value in recovering the calorific value of this gas produced in ferrochromium production and using it as fuel in neighbouring plants. This can be done at hot and/or cold rolling mills provided that they are close to a ferrochromium production plant. For this purpose, technique (e) of BAT 150 in the NFM BREF specifies that the CO-rich exhaust gas generated in the ferrochromium production processes via a closed submerged arc furnace or in a closed plasma dust process can be used as fuel in neighbouring plants provided that there is a demand for this fuel and that it is economically viable to do so. [[34, COM 2017](#)]

Achieved environmental benefits

Efficient use of energy resources.

Environmental performance and operational data

No information provided.

Cross-media effects

With regard to NO_x formation, the individual combustion gases show a different behaviour. For instance, higher NO_x emissions are observed when a high share of COG is used in the fuel mix used in the furnace.

There are two reasons why NO_x emissions are higher with coke oven gas: higher flame temperature and fuel nitrogen. The composition of the exhaust gas is related to the flame temperature. Methane (natural gas) burns relatively slowly compared to fuels with a high H₂ content (e.g. coke oven gas) that tend to burn more quickly and have a higher NO_x emission level. The type of burner should be appropriate for the available fuel(s). [[4, EUROFER 1998](#)]. Fuel NO_x results from the oxidation of the ammonia and organic nitrogen as contained in, for example, the COG. Because of relatively high amounts of ammonia and organic nitrogen in the COG, fuel NO_x is generated. The amount of fuel NO_x is related to the cleaning of COG: higher levels of ammonia in treated COG result in higher NO_x emissions. [[22, COM 2013](#)], [[23, Lecomte et al. 2017](#)], [[31, EUROFER 10-7-18 2018](#)]

In the case of CO-rich gas from ferrochromium production, this gas exhibits a very low sulphur content but generates a significantly higher flame temperature (about 2 120 °C) in comparison

to propane or natural gas (about 1 960°C), potentially giving rise to higher thermal NO_x emissions.

Technical considerations relevant to applicability

Only applicable when iron and steel process gases and/or CO-rich gas from ferrochromium production are available.

Economics

No information provided.

Driving force for implementation

Improved energy efficiency.

Example plants

Widely used for iron and steel process gases.

The data collection shows that one cold rolling plant (i.e. Plant 158 CR) and one hot rolling plant (i.e. Plant 158 HR) are using CO-rich exhaust gas generated from a ferrochromium production plant, as specified in the NFM BAT conclusions.

Reference literature

[16, FMP TWG 2018], [22, COM 2013], [23, Lecomte et al. 2017], [30, AT 31-5-17 2017], [31, EUROFER 10-7-18 2018], [33, Niemela et al. 2004], [34, COM 2017].

2.4.2.2 Optimised furnace door design

Description

Minimisation of heat losses from opening of the furnace door openings, e.g. by using several liftable segments instead of one in continuous reheating furnaces.

Technical description

Conventional (one-segment) furnace charging doors leave gaps beside the feedstock through which furnace gases escape or ingress air may be sucked into the furnace. This results not only in uncontrolled (fugitive) emissions, but also in a loss of waste gas which could otherwise be used for combustion air preheating. The recuperation efficiency is thus reduced. In the case of air ingress into the furnace, scale formation increases which has a negative influence on slab quality and production yield. [25, EUROFER 2018]

Charging doors

State-of-the-art furnaces are equipped with charging doors consisting of several individual liftable segments. The width of the segments corresponds to the length of the feedstock in reasonable steps. Accordingly, the furnace charging door can be partly opened and the gaps beside the feedstock are reduced. [25, EUROFER 2018]

In the reference plant, the furnace door design comprises a number of individual single doors (e.g. 64 doors on a width of 15.6 m) which can be lowered down on the refractory to the left and right of the feedstock. [35, Münch 1997]

All segments are lifted together and when part of the slab has passed the door all segments are lowered. Those which are beside the slab close the gap. The others slide over the slab and fall down when it has entered the furnace. [25, EUROFER 2018]

In the case of roller hearth furnaces, the doors are modified with a special curtain that slides over the surface on top of the slab. [25, EUROFER 2018]

Discharging doors

On the discharge side, it is fundamental to ensure airtightness and efficient thermal insulation. State-of-the-art furnaces are equipped with solid-state dry discharging doors, composed of one

or two elements. Optimised discharging doors prevent heat losses into the furnace, improve the temperature homogeneity of the reheated products, and enable a better control of the air in excess. No ingress air is sucked into the furnace, preventing scale formation and improving the quality of the combustion. [25, EUROFER 2018]

Achieved environmental benefits

Reduced energy consumption.

Environmental performance and operational data

The change of the furnace door design (of a walking beam furnace) resulted in an increase of the air preheat temperature (recuperation) of 60 °C with a reduction in energy consumption of 0.05 GJ/t. [35, Münch 1997]

Cross-media effects

No negative effects on other media are known.

Technical considerations relevant to applicability

Only applicable to new plants and major plant upgrades.

Economics

The higher technical complexity and financial expenses must be reasonable when compared with the charging schedule. A technical solution must be available from the furnace supplier. [3, EUROFER 2020]

Driving force for implementation

Energy savings.

Example plants

ArcelorMittal Bremen, ArcelorMittal Ghent, Thyssenkrupp Steel Europe AG - Duisburg-Beeckerwerth.

Reference literature

[25, EUROFER 2018], [35, Münch 1997].

2.4.2.3 Regenerative burner

Description

Regenerative burners consist of two burners which are operated alternately and which contain beds of refractory or ceramic materials. While one burner is in operation, the heat of the exhaust gas is absorbed by the refractory or ceramic materials of the other burner and then used to preheat the combustion air.

Technical description

See Section 8.5.4.3 for a detailed technical description.

Achieved environmental benefits

- Reduced energy consumption.
- Reduction of the total volume of flue-gases.

Environmental performance and operational data

Example:

A UK plant operating a walking beam furnace to heat various sizes of mild steel tube (up to 200 mm in diameter and 15 m long) from cold to 1 050 °C changed its firing system to regenerative burners. The old 44 nozzle mix, natural-gas-fired burners were replaced by 12 pairs of regenerative burners. At the same time, the roof profile was modified to improve zone control and hot gas circulation. As a result of the plant modification the specific energy consumption was reduced from typically 3.55 GJ/t to 1.7 GJ/t, giving a 52 % saving in fuel use. The

productivity potential was improved by 14 %. The payback period was less than three years. [11, ETSU - b 1993]

Advantages and disadvantages of regenerative burners:

Higher NO_x emissions may occur, but, combined with lower energy consumption and waste gas flow reduction, the specific NO_x emission (in g/tonne of steel) is comparable with the specific NO_x emission level reached with other systems. [4, EUROFER 1998]

A drawback of regenerative systems is their sensitivity to dust. If the heating process generates substantial amounts of dust the permeability of the ceramic fillings in the regenerator drops very quickly and consequently the fillings have to be replaced. This appears to be a minor problem in reheating furnaces in steel plants. [4, EUROFER 1998]

Regenerative burners are usually bigger than conventional burners. Thus limited space can be an obstacle for installing regenerative burners in existing plants. To date, it has not been possible to use regenerative systems for roof burners. [4, EUROFER 1998]

A regenerative system might be considered for the construction of new reheating furnaces in those cases where, due to the plant layout, the length of the reheating furnace has to be limited. In the same way, an increase in the production capacity of an existing furnace is possible by installing a regenerative system without increasing the length of the furnace (which in most cases is a fixed specification). [4, EUROFER 1998]

This system is particularly interesting for batch processes because batch processes generally do not contain a preheat zone. In continuous furnaces equipped with a central recuperator system, a similar thermal efficiency is reached by means of a long unheated (preheat) zone, where the heat of the flue-gases is transmitted by convection to the cold stock. A thermal efficiency of the furnace of 80 % can be achieved. [4, EUROFER 1998]

Implementation at existing furnaces may be difficult as the two burners of one set have to be installed opposite to each other. Furnace pressure is affected; therefore a new system/model for furnace pressure regulation becomes necessary. [31, EUROFER 10-7-18 2018]

The use of process gas is challenging because regenerative burner systems are sensitive to dust accumulation. When coke oven gas is used with regenerative burners, there are acidic excretions in the exhaust gas which can cause corrosion on the switch valves and other equipment. [31, EUROFER 10-7-18 2018]

Table 2.18: Typically achievable reductions for regenerative systems

Regenerative systems	Reduction [%]	
	NO _x	Energy ¹
	50	40

Notes: Source: [4, EUROFER 1998] Basis is a furnace with a yearly capacity of 1.5 Mt fired with natural gas with standard burners and without air preheat. Investment costs can be site specific (available room, layout of the existing furnace, number of side and bottom burners)

¹ In percentage terms, the energy reduction is matched by the reduction in SO₂, CO and CO₂ emissions

Cross-media effects

- Reduced fuel consumption has a positive effect on SO₂ and CO₂ emissions.
- Higher level of maintenance with a potential increase of the MTBF (Mean Time Between Failure). [31, EUROFER 10-7-18 2018]

Technical considerations relevant to applicability

Generally applicable within the constraints related to the need to control NO_x emissions.

Economics

The higher investment costs (regenerative system, more expensive burners) may be compensated by the benefits of shortening the length of the furnace (new plant) and increased fuel efficiency. [4, EUROFER 1998]

Driving force for implementation

Improved energy efficiency.

Example plants

Plants from the data collection: 126 HR, 138 HR, 139 HR, 147 HR, 158 HR, 174 HR, 175 HR, 197 HR, 205 HR, 230 HR, 231 HR, 246 HR2, 248 HR2.

Reference literature

[4, EUROFER 1998], [11, ETSU - b 1993], [16, FMP TWG 2018], [31, EUROFER 10-7-18 2018], [37, ETSU 1993].

2.4.2.4 Recuperative burner

Description

Recuperative burners employ different types of recuperators (e.g. heat exchangers with radiation, convection, compact or radiant tube designs) to directly recover heat from the exhaust gases, which are then used to preheat the combustion air.

Technical description

See Section 8.5.4.3 for a detailed technical description.

Achieved environmental benefits

- Reduced fuel/energy consumption.
- Reduced volume of waste gas.

Environmental performance and operational data

Compared with cold air combustion systems, recuperators can be expected to achieve energy savings of around 30 %. A combination of a recuperator with a low-NO_x burner can result in a reduction of energy consumption of 25 % while reducing NO_x emissions by 50 %. A recuperative burner can achieve NO_x reductions of up to 30 % and reduce energy consumption by 25 %. [31, EUROFER 10-7-18 2018]

Table 2.19: Typically achievable reductions and cost data for recuperators and recuperative burners

	Reduction [%]	
	NO _x	Energy ¹
Recuperator with low-NO_x (2nd generation)	50	25
Recuperative burner	30	25

Notes: Source: [4, EUROFER 1998] Basis is a furnace with a yearly capacity of 1.5 Mt fired with natural gas with standard burners and without air preheat. Investment costs can be site specific (available room, layout of the existing furnace, number of side and bottom burners)

¹ In percentage terms, the energy reduction is matched by the reduction in SO₂, CO and CO₂ emissions

Cross-media effects

- The NO_x emission concentrations increase with rising combustion air temperature. At the air temperature level achieved with a central recuperator, normally almost no increase in NO_x emissions is expected. Otherwise, preheating of combustion air leads to lower fuel consumption and to a lower NO_x freight load (mg) (in spite of the small increase in NO_x concentration). [31, EUROFER 10-7-18 2018]

- Reduced energy consumption has a positive effect on the SO₂, CO₂ and NO_x load because of the reduced waste gas flow. [31, EUROFER 10-7-18 2018]

Technical considerations relevant to applicability

Generally applicable within the constraints related to the need to control NO_x emissions.

Economics

No information provided.

Driving force for implementation

Increased energy efficiency and reduced fuel consumption. [31, EUROFER 10-7-18 2018]

Example plants

Widely used.

Reference literature

[16, FMP TWG 2018], [26, Hot Rolling Shadow Group 1999], [31, EUROFER 10-7-18 2018].

2.4.2.5 Oxy-fuel combustion

Description

Combustion air is replaced fully or partially by pure oxygen.

Technical description

Reheating of steel slabs is a very energy-intensive process that uses high-calorific-value gaseous or liquid fuels to reach the high temperatures required. When standard air is used in the combustion process, large volumes of nitrogen enter the furnaces and are heated up by combustion of the fuel at high temperature prior to being exhausted to the atmosphere, resulting in significant energy losses and elevated NO_x emissions. When using the oxy-fuel technology, the combustion air composed of 78 % nitrogen and 21 % oxygen is replaced by oxygen (≥ 90 % purity). [31, EUROFER 10-7-18 2018]

Three stoichiometric equations are shown to illustrate different cases of combusting methane with (i) air combustion, (ii) pure oxygen combustion and (iii) mixed combustion with 50 % oxygen enrichment in the combustion air.

- Normal air combustion with 21 % O₂ and 78 % N₂:

$$\text{CH}_4 + 2 (\text{O}_2 + 3.76 \text{N}_2) \rightarrow \text{CO}_2 + 2\text{H}_2\text{O} + 7.52 \text{N}_2$$
- 100 % oxy-fuel combustion:

$$\text{CH}_4 + 2\text{O}_2 \rightarrow \text{CO}_2 + 2\text{H}_2\text{O}$$
- Oxygen-enriched air combustion with 50 % O₂ and 50 % air:

$$\text{CH}_4 + 2 (\text{O}_2 + \text{N}_2) \rightarrow \text{CO}_2 + 2\text{H}_2\text{O} + 2\text{N}_2$$

The removal of nitrogen from the combustion process improves the energy efficiency of the furnace because the final volume of combustion products is significantly reduced when replacing air with oxygen (e.g. down to only three times the volume of fuel used in the case of 100 % oxy-fuel combustion). As a result, the heat generated will be more available to heat up the furnace load. This effect is clearly illustrated in Figure 2.76 where the percentage of available heat in the furnace is plotted against the exhaust gas temperature for different air/oxygen ratios. [31, EUROFER 10-7-18 2018]

The removal or reduction of nitrogen in the combustion gases also results in a lower exhaust gas volume per unit of energy added (expressed in Nm³ exhaust/kWh) and an increase in the

concentration and partial pressures of CO₂ and H₂O. Heat radiation mostly originates from CO₂ and H₂O present in the combustion gases. Accordingly, high concentrations of CO₂ and H₂O considerably increase heat transfer in the furnace. [31, EUROFER 10-7-18 2018], [38, Schéele 2010]

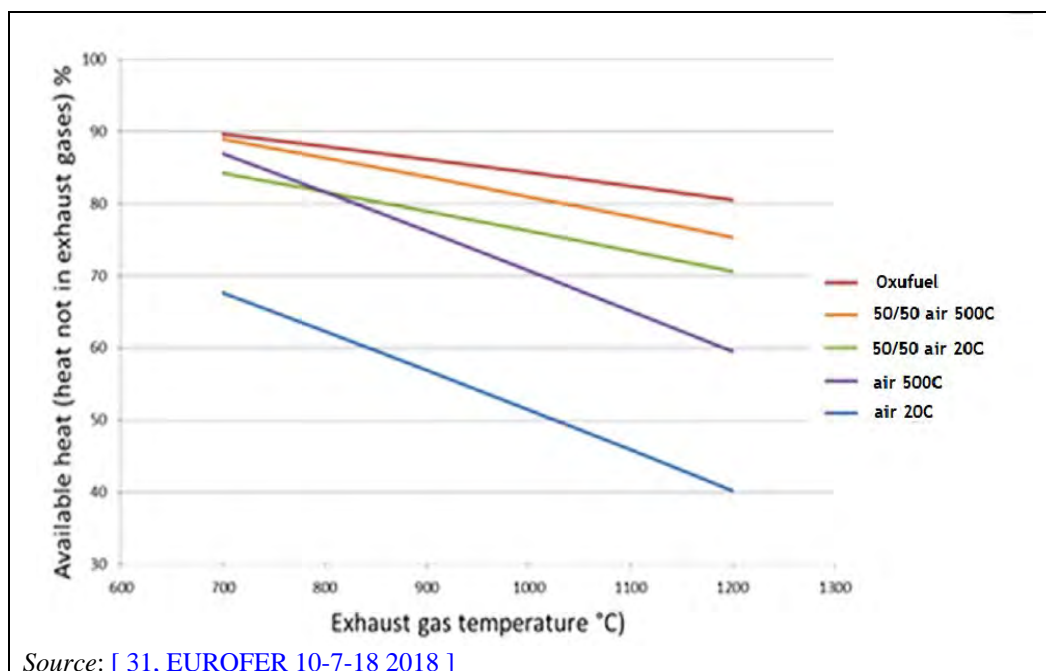


Figure 2.76: Available heat versus exhaust gas temperature for different air preheat temperatures

Finally, since the volume flow of exhaust gases is much less in the case of oxygen-enhanced combustion, the heat is released to the feedstock more efficiently. Besides, the conversion from air to oxygen-enhanced combustion often leads to a lower exit exhaust gas temperature.

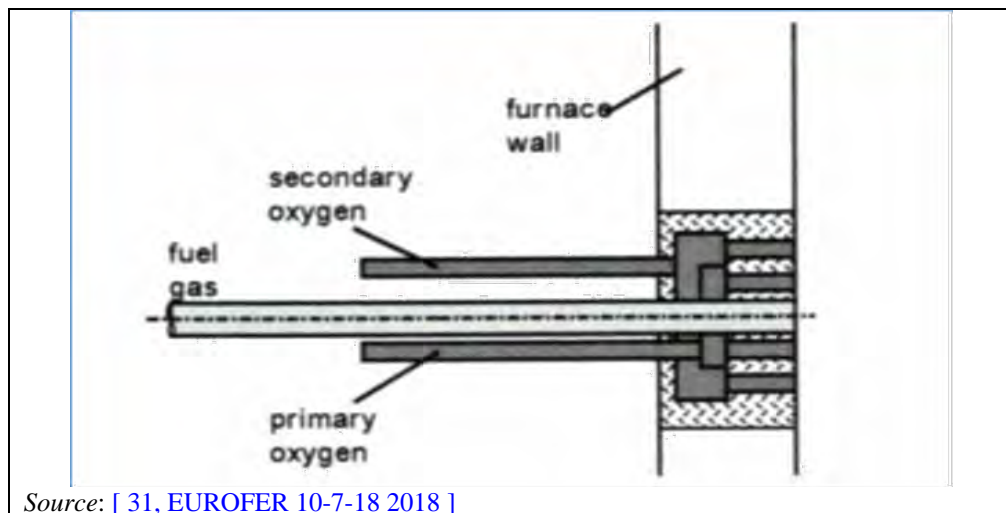
Several configurations are possible for using the oxy-fuel technology in reheating and heat treatment furnaces including the following:

- **Oxy-fuel burner with 100 % oxygen**

In this configuration, oxy-fuel burners are employed with 100 % oxygen and no air. The design can vary depending on the specific situation (e.g. type of fuel used and burner position). Like for air burners, the oxy-fuel burner might need a pilot burner or a flame-stabilising system in order to operate at temperatures below self-ignition temperatures.

Impact on NO_x emissions

Although in theory a furnace without nitrogen does not produce NO_x, most industrial furnaces have leakages where ambient air can enter into the furnace and as a result NO_x is formed. To achieve low NO_x emissions using an oxy-fuel burner, the fuel and oxygen injection points are normally separated in order to dilute the concentration of oxygen (often below 21 % O₂) and fuel before the combustion reaction takes place, as depicted in Figure 2.77. A high injection velocity promotes recirculation of combustion products into the oxygen and fuel. A low concentration of oxygen and fuel in the flame reduces the peak flame temperature and suppresses NO_x formation. [31, EUROFER 10-7-18 2018]



Source: [31, EUROFER 10-7-18 2018]

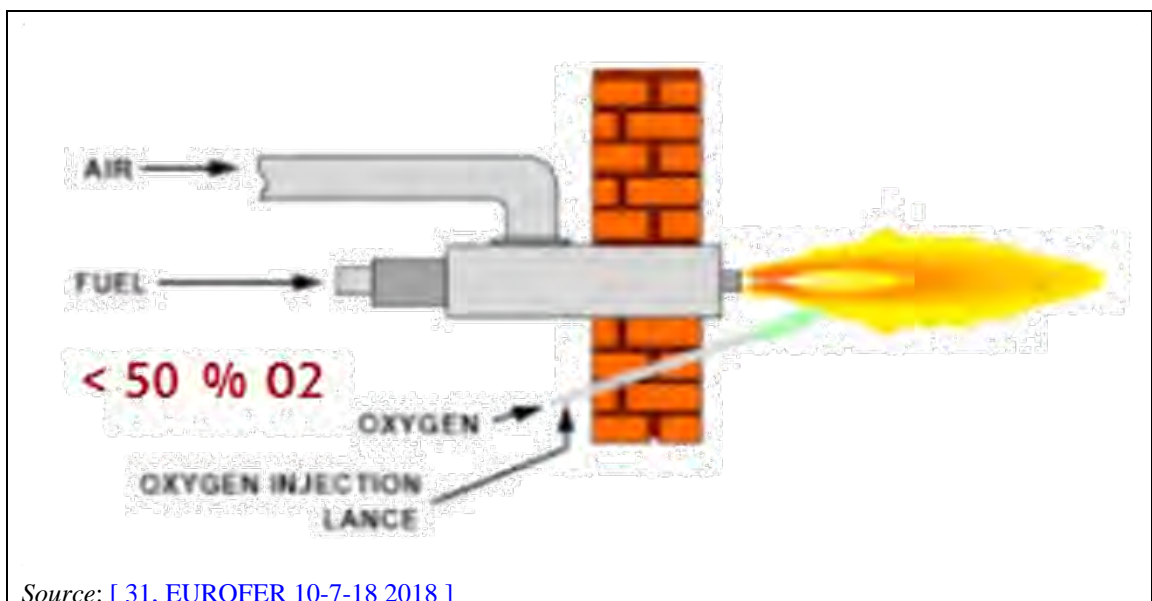
Figure 2.77: Schematic of a typical oxy-fuel burner operating with 100 % oxygen

- **Oxygen enrichment using conventional burners**

This technique consists of adding oxygen into the combustion air to increase the oxygen content from 21 % to about 25–28 % in the air stream. The conventional burners employed for air combustion can usually be used and the benefit is that it is very easy to switch between oxygen-enriched mode and normal air-fuelled mode if required. One disadvantage is that the burner design very seldom is designed for the purpose and that the NO_x emissions tend to increase. [31, EUROFER 10-7-18 2018]

- **External lancing of oxygen**

The external lancing of oxygen technique is a specific application developed to enable the benefits of oxy-fuel combustion in existing furnaces without the need to replace the burners themselves. Instead of adding oxygen into the combustion air stream of each burner as done with traditional oxygen enrichment, oxygen is injected at high velocity at a short distance from the burner, allowing the oxygen to be diluted by furnace fumes before it takes part in the combustion (see Figure 2.78). Oxygen enrichment levels of approximately 30–50 % can be reached. Using external lancing of oxygen, combustion similar to that of a flameless oxy-fuel burner is achieved and resulting in reduced NO_x emissions. [31, EUROFER 10-7-18 2018], [39, Niemi et al. 2013]



Source: [31, EUROFER 10-7-18 2018]

Figure 2.78: Schematic of a burner with external lancing for oxygen injection

For oxygen enrichment and external lancing, it is important to have good control of the flow of air, oxygen and fuel in order to achieve the correct total oxygen to fuel ratio. [40, EUROFER 31-3-17 2017]

The choice between the three oxy-fuel options presented above (i.e. 100 % oxygen burner, oxygen enrichment or external lancing) depends on the plant characteristics and performance. For instance, when additional heating capacity in the furnace is needed, the use of 100 % oxy-fuel burners might be the best option. For furnaces equipped with ordinary air-fuelled burners exhibiting good efficiency, the external lancing technique could be the best solution to further reduce energy consumption and reduce NO_x emissions. [31, EUROFER 10-7-18 2018], [41, EUROFER 2020]

Potential issues to consider are the need to adapt the burner control system or the potential need to change an exhaust valve or fan or make adjustments to the controlling parameters. These seem to be plant-specific, but mostly manageable technical changes.

Achieved environmental benefits

- Reduced energy consumption and CO₂ emission.
- Reduced CO and NO_x emissions.

Environmental performance and operational data

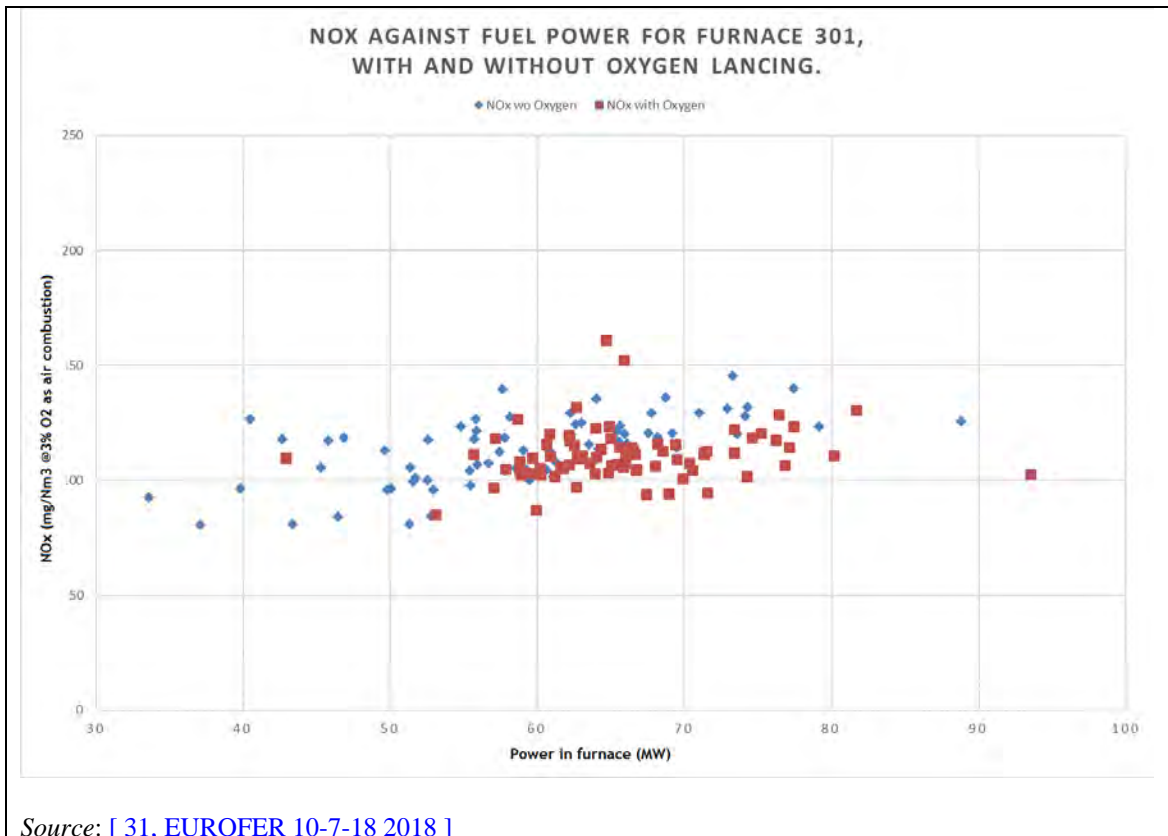
In general, the following improvements are obtained using the oxy-fuel technology: [31, EUROFER 10-7-18 2018]

- An increase in the partial pressures of CO₂ and H₂O and longer residence times for gases in the furnace result in higher heat transfer by gas radiation, reduced heating time and increased productivity.
- A significant reduction in the exhaust flue-gas volumes and the exhaust flue-gas temperature, resulting in smaller downstream waste gas abatement systems in terms of size.
- The injection of oxygen can result in an increase in the flame temperature and can be controlled independently from the furnace operation, if required.
- The replacement of air in the burner with pure oxygen reduces the partial pressure of nitrogen gas and can reduce thermal NO_x formation. However, if oxygen is injected near the burner or if there is significant air ingress in the furnace, higher specific NO_x emissions (expressed in mg/Nm³) are possible due to the higher gas temperature. However, the overall mass emissions of NO_x (expressed as mass-NO_x/tonne produced or mass-NO_x/energy used) are reduced because of the significant reduction in the total volume of exhaust gases achieved with the oxy-fuel technology.
- Reduced specific energy consumption.
- Reduced need for and dependency on heat recovery systems.
- In integrated steelworks, there is an increasing need to combust low-calorific fuels (e.g. fuels exhibiting a calorific value below 2 kWh/m³) such as blast furnace gas (e.g. calorific value < 1 kWh/m³). For such fuels, the use of oxygen is an absolute requirement for flame temperature and stability. [38, Schéele 2010]
- Reduction of CO₂ emissions compared to air-fuelled furnaces. [42, Lantz et al. 2008]

For example, at SSAB reheating furnaces in Borlänge, external lancing of oxygen is implemented. The energy savings ranged between 1.7 kWh/m³ and 2.5 kWh/m³ of oxygen depending on production conditions and the furnace. In percentage terms, the energy consumption (and also the CO₂ emissions) has been lowered by 5–16 %, with an average of 10 %. [31, EUROFER 10-7-18 2018]

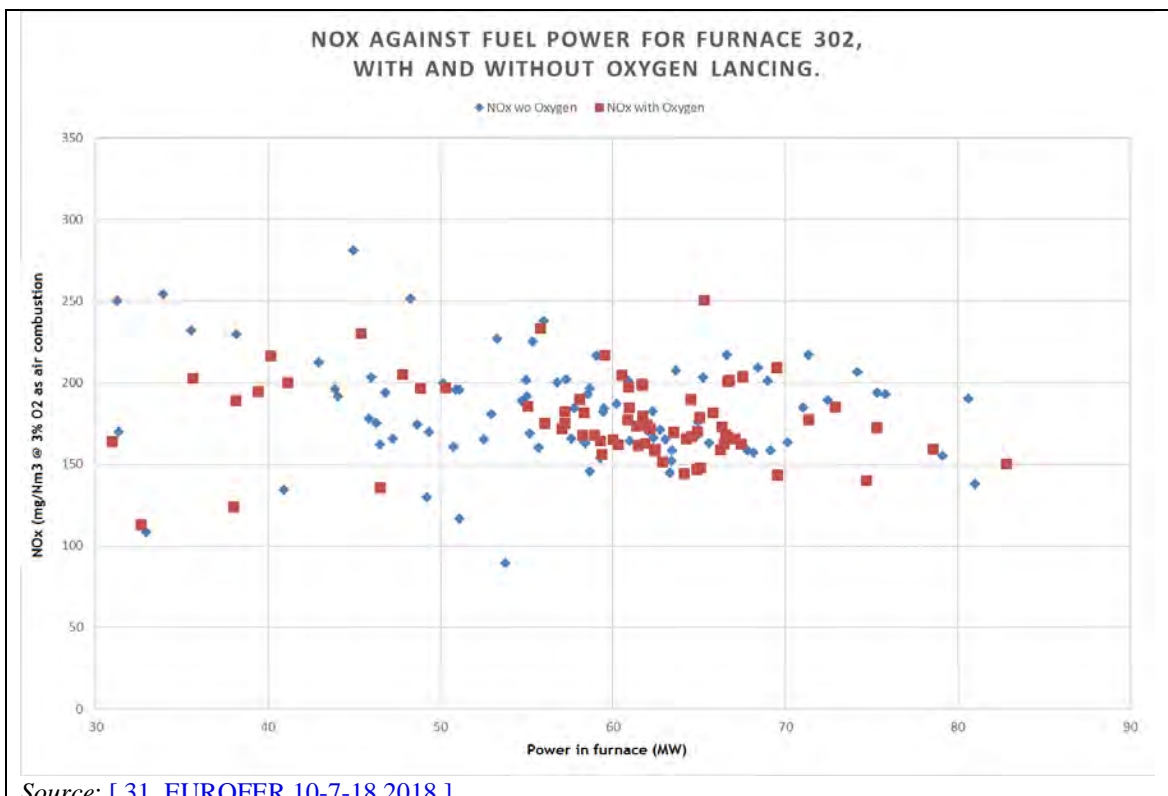
Figure 2.79 and Figure 2.80 below show the NO_x emissions (weekly averages) of furnace 301 and furnace 302 (corresponding to 244 HR-1C and 244 HR-2C, respectively) with and without oxygen lancing for the years 2015-2017. It can be noticed that the NO_x emissions of furnace 301 are slightly less when using oxygen compared to when not using oxygen. For furnace 302

the NO_x emissions are almost the same for both operating options. [31, EUROFER 10-7-18 2018]



Source: [31, EUROFER 10-7-18 2018]

Figure 2.79: NO_x emissions versus fuel power for reheating furnace 301 (SSAB, Borlänge)



Source: [31, EUROFER 10-7-18 2018]

Figure 2.80: NO_x emissions versus fuel power for reheating furnace 302 (SSAB, Borlänge)

At the Arcelor Mittal Shelby plant (USA), where data are provided for a rotary hearth furnace, an initial reduction in energy consumption of 29 % is reported due to oxygen enrichment. Subsequently, 65 % energy consumption is reported as a result of oxy-fuel combustion in combination with flameless oxidation as well as 76 % NO_x emissions reduction compared to the initial air fuel technique. [41, EUROFER 2020], [42, Lantz et al. 2008]

Cross-media effects

- Higher NO_x emission concentrations may occur, although overall NO_x emissions are reduced.
- The potential safety hazard from using pure oxygen requires that additional precautions are put in place to ensure safety in the workplace.
- Taking into consideration the overall environmental impact and total energy use, the environmental impact and energy consumed for the production of electricity used in oxygen production have to be considered. Energy demand for oxygen production differs if oxygen is to be separated into a gaseous or into a liquid state. Example figures for energy consumption are 278 kWh/t (0.4 kWh/Nm³ O₂) for gaseous oxygen production and 800 kWh/t (1.14 kWh/Nm³ O₂) for liquid oxygen production. Accounting for the total energy consumed relating to the production of electricity used in the separation of oxygen, the total number could reach 3.27 kWh/Nm³ O₂ depending on the source of electricity (i.e. combustion plant with net efficiency 35 %). [41, EUROFER 2020]

Technical considerations relevant to applicability

- Applicability may be restricted for furnaces processing high-alloy steel. For example, implementing this technique for the production of high-strength steel in a hot dip coating line is not possible due to the related oxidation of the surface.
- Applicability to existing plants may be restricted by furnace design and the need for a minimum waste gas flow. Indeed, depending on the furnace design (e.g. draft system), a minimum flue-gas volume/flow may be required to ensure the correct operation of the furnace/combustion and the transport of the combustion gases through the furnace and the flue-gas exhaust.
- Not applicable to furnaces equipped with radiant tube burners.

Economics

- Low investment costs in furnace. If an oxygen production plant has to be built, the investments costs are high. [41, EUROFER 2020]
- Oxy-fuel combustion in a reheating furnace may result in an increase of the throughput of heated material (i.e. slabs). If oxy-fuel combustion is installed and higher productivity is achieved, it is necessary to secure a production increase also in the subsequent production steps (e.g. rolling, roughing, decoiling, intermediate heating) to avoid high running costs.
- The main operating cost of oxy-fuel combustion is the cost of oxygen. The oxy-fuel technology can only be considered a viable solution if oxygen is available at a low price, enabling cost savings when comparing the price of energy and fuel consumption and the price of purchasing oxygen.
- High-purity oxygen may be replaced with oxygen with a purity of around 90 %, thus reducing costs.
- Higher furnace temperatures are reached, resulting in reduced process time and increased productivity.

Driving force for implementation

- Increased productivity.
- Energy savings.
- Overall reduction of NO_x emissions.

Example plants

- SSAB Borlänge, furnaces 301 and 302 (Sweden).
- Ovako Steel Hofors, 3 Rotary Hearth Furnaces, 5 Chamber furnaces, 48 pit cells (Sweden).

- Ovako Bar AB, Smedjebacken WHF (Sweden).
- Outokumpu Stainless, Avesta APL 76 (Sweden).
- Outokumpu Stainless, Degerfors (Sweden).
- Sandvik Materials Technology (Sweden).
- Outokumpu Stainless, Tornio (Finland).
- ArcelorMittal, Galati (Romania).
- Ascometal, Fos Sur Mer and les Dunes (France).
- ArcelorMittal Shelby Tubular Products (USA) %. [[42, Lantz et al. 2008](#)].
- Plants from the data collection: 242 HR, 244 HR, 246 HR2, 247 HR

Reference literature

[[16, FMP TWG 2018](#)], [[31, EUROFER 10-7-18 2018](#)], [[38, Schéele 2010](#)], [[39, Niemi et al. 2013](#)], [[41, EUROFER 2020](#)], [[42, Lantz et al. 2008](#)], [[206, BE 2021](#)].

2.4.2.6 Flameless combustion

Description

Flameless combustion is achieved by injecting fuel and combustion air separately into the combustion chamber of the furnace at high velocity to suppress flame formation and reduce the formation of thermal NO_x while creating a more uniform heat distribution throughout the chamber. Flameless combustion can be used in combination with oxy-fuel combustion.

Technical description

Flameless combustion can be achieved using conventional air-fuelled furnaces equipped with a flameless burner or using oxy-fuel flameless burners.

Flameless combustion

Heating and heat treatment furnaces of the iron and steel industry usually operate at high process temperatures. Whereas energy losses can be minimised with recuperative burners using the exhaust gases to preheat the combustion air, the formation of nitrogen oxides also increases at higher temperatures of the combustion air. Atmospheric nitrogen oxidises in particular in the hot zones of the flame front to form nitrogen oxides. [[31, EUROFER 10-7-18 2018](#)]

Flameless combustion can be achieved with intense mixing of the fuel gas, the combustion air and the recirculated exhaust gases. Fuel gas and combustion air are injected separately into the combustion chamber at high velocity. Inside the combustion chamber, a very intensive internal flue-gas circulation mixes the combustion air, the fuel gas and the products of combustion. Under these conditions, flameless combustion occurs provided that the combustion temperature inside the furnace is above the auto-ignition of the mixture (e.g. > 800 °C using natural gas and air) and the flue-gas recirculation ratio is higher than three. [[31, EUROFER 10-7-18 2018](#)], [[43, Abuelnor et al. 2014](#)]

With flameless combustion, the temperature peak of the flame front does not exist, reducing to a large extent the formation of NO_x in comparison with conventional burners. Another additional benefit provided by flameless combustion is that the fuel oxidises throughout the entire volume of the combustion chamber, providing a very homogeneous furnace temperature. With the uniform distribution, it is possible to maintain a higher average combustion chamber temperature, resulting in reduced heating time, and lower CO emissions since complete combustion is achieved. Finally, flameless combustion results in lower noise emissions and reduced thermal stress for the burner. [[31, EUROFER 10-7-18 2018](#)], [[43, Abuelnor et al. 2014](#)]

Flameless combustion in combination with oxy-fuel

Flameless technology can be used in combination with the oxy-fuel technique. The oxy-fuel technique principles are described in Section 2.4.2.5. Briefly, this technique involves the

replacement of the combustion air with oxygen (> 90 % purity) which means less nitrogen to be heated and a reduction of the total exhaust gas volume, leading to increased energy efficiency.

Flameless oxy-fuel combustion is achieved by dilution of the by separately injecting the fuel and oxygen at high velocities into the furnace. [38, Schéele 2010]

Recirculating the flue-gases into the combustion zone results in a reduction of peak temperature and thermal NO_x formation. Compared to non-flameless oxy-fuel combustion, the temperature distribution in the furnace will be more uniform, resulting in the possibility to increase the production rate and/or lower the energy consumption depending on the furnace characteristics and production situation. [41, EUROFER 2020]

Achieved environmental benefits

- Reduced NO_x emissions.
- Reduced CO emissions.
- Reduced energy consumption.

Environmental performance and operational data

Flameless oxy-fuel combustion is installed at two sites belonging to Ascométal at Fos-sur-Mer (France). In total, nine soaking pit furnaces have been retrofitted with flameless oxy-fuel burners. As a result, the heating capacity increased by 50 %, fuel consumption was reduced by 40 % and NO_x emissions were reduced by 40 %. [44, Iron and Steel Today 2008]

In 2003, a walking beam furnace belonging to Outokumpu Stainless situated in Degerfors (Sweden) was rebuilt and refurbished by replacing the air-fuelled system (including recuperators) with flameless oxy-fuel burners. As a result, the heating capacity increased by 40–50 %, the fuel consumption was reduced by 25 % and overall NO_x emissions lower than 70 mg/MJ were achieved. [44, Iron and Steel Today 2008]

Other co-benefits of the flameless oxy-fuel combustion technique include reduce scale formation and reduced noise emissions.

The bogie hearth furnace B9 of voestalpine Grobblech is heated with natural gas and has several regulating zones. The burners of the B9 bogie hearth furnace use preheated air at approximately 600 °C and are designed as flameless burners with air staging and exhaust gas recirculation. NO_x and CO emissions are significantly reduced when a furnace chamber temperature of > 800 °C or > 850 °C is reached. NO_x emissions are 110.7 mg/Nm³, 140.3 mg/Nm³ and 140.4 mg/Nm³ (3 half-hour measurements) at a temperature of 620 °C, and 50.3 mg/Nm³, 65.7 mg/Nm³ and 81.9 mg/Nm³ (3 half-hour measurements) at a temperature of 920 °C; and carbon monoxide emissions are 4.1 mg/Nm³, 4.0 mg/Nm³ and 3.9 mg/Nm³ (660 °C) and 24.0 mg/Nm³ and 15.7 mg/Nm³ (920 °C). The emissions refer to an oxygen content of 5 %. (AT comments in [24, TWG 2019])

Figure 2.81 provides an example of a reheating furnace retrofitted with air-flameless combustion in two steps (2006 and 2008 - SSAB Borlänge, furnace 301). Initially (before 2006), only low-NO_x burners were used in furnace 301. In 2006, flameless combustion was partially installed in some parts of the furnace. The complete installation of flameless combustion was realised towards the end of 2008. A clear reduction in NO_x emissions was observed between 2006 and 2008. Overall, the NO_x emissions were reduced from an initial value of approximately 315 mg/Nm³ at 3 % O₂ to 145 mg/Nm³ at 3 % O₂. [41, EUROFER 2020]

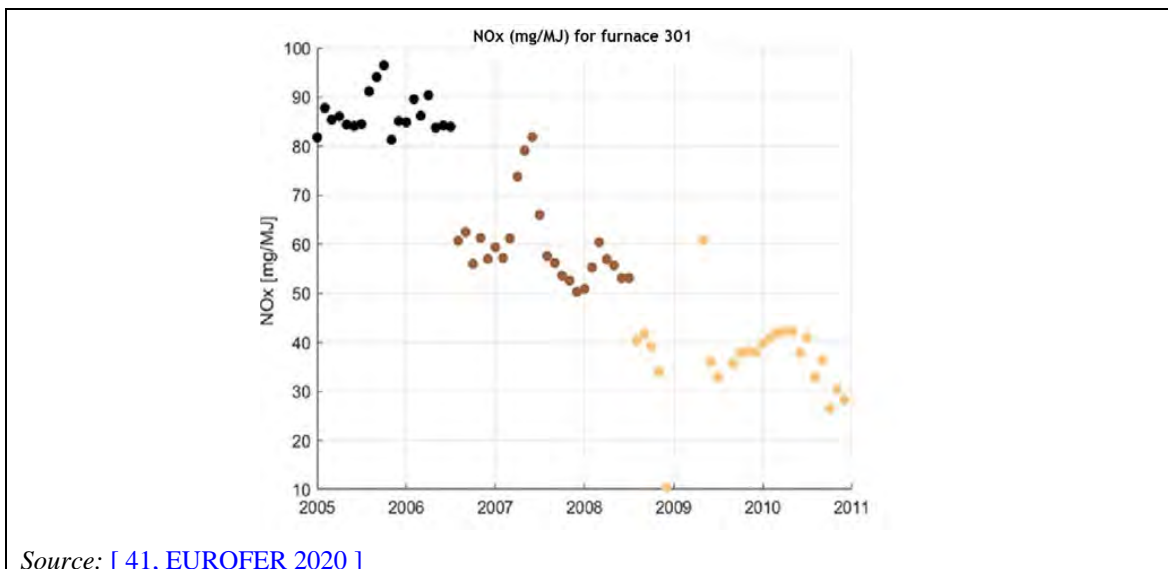


Figure 2.81: Monthly average NO_x emissions (expressed in mg/MJ) at SSAB Borlänge (Furnace 301) - prior to flameless combustion (black dots), after flameless combustion was installed in parts of the furnace (brown dots), and after complete installation of flameless combustion in the furnace (yellow dots)

For SSAB Borlänge (furnace 301), Figure 2.82 also provides energy consumption prior to the installation of flameless combustion, after the installation of flameless combustion in parts of the furnace and after complete installation of flameless combustion in the furnace. [41, EUROFER 2020]

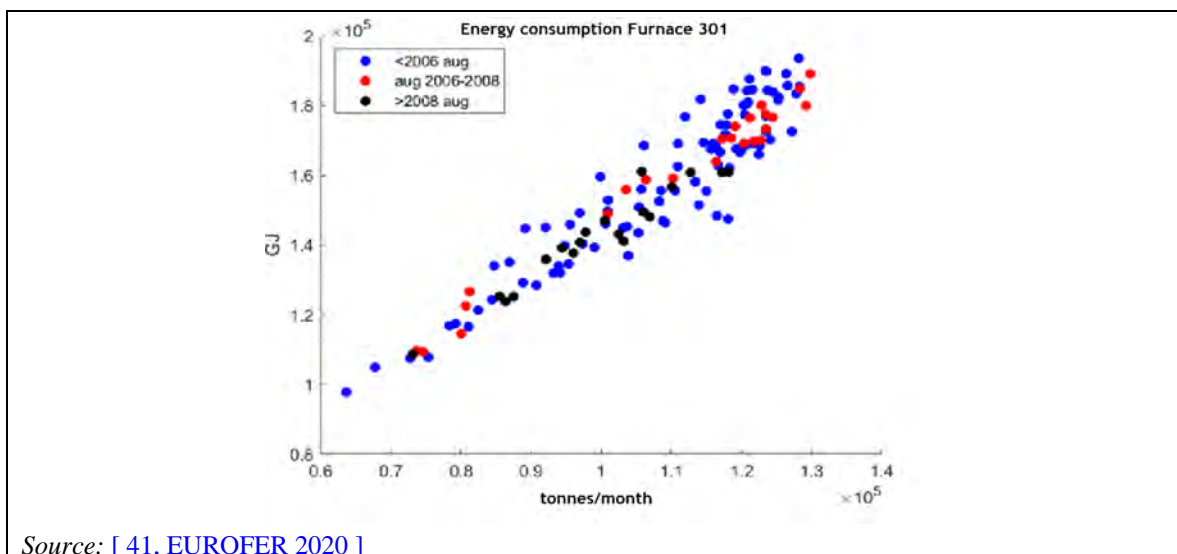


Figure 2.82: Energy consumption (expressed in GJ/t) at SSAB Borlänge (Furnace 301) - prior to flameless combustion (blue dots), after flameless combustion was installed in parts of the furnace (red dots), and after complete installation of flameless combustion in the furnace (black dots)

Cross-media effects

When used in combination with oxy-fuel combustion, the cross-media effects reported for oxy-fuel combustion in Section 2.4.2.5 also apply to flameless combustion.

Technical considerations relevant to applicability

- Applicability to existing plants may be limited by furnace design (i.e. furnace volume, space for burners, distance between burners) and the need to change the refractory lining.
- Applicability may be limited for processes where close control of the temperature or temperature profile is required (e.g. recrystallisation).
- Not applicable to furnaces operating at a temperature lower than the auto-ignition temperature required for flameless combustion or to furnaces equipped with radiant tube burners.

Economics

- Application of oxy-fuel burners requires the additional purchase or on-site production of oxygen. Accordingly, the flameless oxy-fuel technique is often only economically viable at plants where oxygen is available at a low price. To study the economic viability of an installation, the expected cost savings in energy and fuel needed are compared with the purchase price of oxygen. [[31, EUROFER 10-7-18 2018](#)]
- Higher average furnace temperatures are reached, which could result in reduced heating time and increased productivity.

Driving force for implementation

- Increased productivity.
- Energy savings.
- Overall reduction of NO_x emissions.

Example plants

- Ascométal - Soaking pit furnaces (Fos-sur-Mer, France).
- Outokumpu Stainless - Walking beam and catenary furnaces (Degerfors, Sweden).
- SSAB Borlänge (Sweden).
- Voestalpine Grobblech (Austria).
- Plants in the data collection reporting the application of flameless oxidation combined with air staging: 89 HR, 97 HR, 175 HR, 179 HR, 205 HR, 222 HR, 244 HR.
- Plants in the data collection reporting the application of flameless oxidation combined with oxy-fuel technology: 37 HR, 110 HR2, 222 HR, 242 HR, 246 HR2, 242 HR, 144 CR.

Reference literature

[[16, FMP TWG 2018](#)], [[31, EUROFER 10-7-18 2018](#)], [[41, EUROFER 2020](#)], [[38, Schééele 2010](#)], [[43, Abuelnor et al. 2014](#)], [[44, Iron and Steel Today 2008](#)].

2.4.2.7 Pulse-fired burner

Description

The heat input to the furnace is controlled by the firing duration of the burners or by the sequential start of the individual burners instead of adjusting combustion air and fuel flows.

Technical description

In pulse firing, the control of the burners is frequency-modulated. The burners can be switched between two states, and the cycling of the burners controls the heat input to the furnace. Usually, the burners are fired at high fire for a certain time and then either cycled to low fire or turned off. This cycle can be repeated relatively frequently, in some designs every six seconds. [[45, Curry 2011](#)]

For instance, the burner always operates at nominal gas flow and the power of the burner is adjusted by the firing time of the burner: for example, a heat demand of 40 % means that the burner is operating only for 40 % of the 60-second cycle time. Another option is the modulation of the burner firing rate by a sequential start of the individual burners. [[31, EUROFER 10-7-18 2018](#)]

Even with a low furnace load, the full power of each burner is available. Slab temperature uniformity is improved in the side-fired furnace because heat is brought homogeneously into the whole furnace width in every production condition.

Achieved environmental benefits

Reduction of energy consumption

Environmental performance and operational data

Walking beam furnaces 4 and 5 (WBF 4 and WBF 5), running in parallel, at SSAB Raahe hot strip mill (Finland):

- WBF 4: commissioned in 1997; flow control and top zones equipped with roof burners, bottom zones equipped with side burners, LPG used at top zones and soaking zone.
- WBF 5: commissioned in 2005; last two top zones equipped with roof burners, other zones equipped with side pulse-fired burners, COG/LPG used as fuel, LPG used as fuel in the soaking zone).

Energy consumption is 10 % lower in WBF 5 using side pulse-fired burners. In WBF 5, however, a higher air preheating temperature compared to WBF 4 is used (WBF 4: 340 °C, WBF 5: 440 °C) and this may also affect energy consumption. [\[41, EUROFER 2020 \]](#)

Table 2.20: Energy consumption and NO_x emission concentrations (daily average)

2016 data	WBF 4	WBF 5
Energy consumption (GJ/t)	1.60	1.42
NO _x (mg/Nm ³) (3 % O ₂), periodic	325	360
NO _x (mg/Nm ³) (3 % O ₂), continuous	NI	400
NB: NI = No information provided. <i>Source:</i> [31, EUROFER 10-7-18 2018]		

The installation of pulse-fired burners provides good temperature control both at low and high firing. In addition, the need for auxiliary fuel is minimised on-line.

Cross-media effects

No information provided.

Technical considerations relevant to applicability

Only applicable to new plants and major plant upgrades.

Economics

Investment costs competitive with other techniques. Valve maintenance can add extra costs if impurities are present in the fuel gas.

Driving force for implementation

- Energy savings.
- Reduced amounts of flaring.

Example plants

SSAB Raahe, Finland. HSM/Walking beam furnace 5 (side burners with pulse firing, two modulative top zones), HPM/heat treatment NU1 (total pulse firing), heating 2 + soaking zones of reheating furnaces 3 and 4 in Avilés are equipped with pulse-fired burners.

Reference literature

[\[16, FMP TWG 2018 \]](#), [\[31, EUROFER 10-7-18 2018 \]](#), [\[45, Curry 2011 \]](#).

2.4.2.8 Low-NO_x burners

Description

The technique (including ultra-low-NO_x burners) is based on the principles of reducing peak flame temperatures. The air/fuel mixing reduces the availability of oxygen and reduces the peak flame temperature, thus retarding the conversion of fuel-bound nitrogen to NO_x and the formation of thermal NO_x, while maintaining high combustion efficiency.

Technical description

See Section 8.8.2.8 for a detailed technical description.

Achieved environmental benefits

- Reduced NO_x emissions.
- Increased energy efficiency. [[31, EUROFER 10-7-18 2018](#)]

Environmental performance and operational data

Examples

NO_x emissions at three reheating furnaces equipped with low-NO_x and ultra-low-NO_x burners are shown in the table below.

Table 2.21. Range of NO_x emissions at reheating furnaces equipped with low-NO_x and ultra-low-NO_x burners

Site / Furnace	Burner Type	NO _x emissions range (mg/Nm ³)
Liberty Speciality Steels - Brinsworth - Strip mill / Reheating furnace	Low-NO _x – Roof flat-flame (hot air recuperated) burner	111-265
Liberty Speciality Steels - Rotherham - Billet Annealing and reheating furnace	Low-NO _x – (hot air recuperated) burner	162-266
Liberty Speciality Steels – Stocksbridge - Billet reheating furnace	Ultra-Low-NO _x – FGR burner	120-148
ArcelorMittal - Le Creusot - Heavy Plate Mill (Tunnel reheating furnace: FSM2)	Low-NO _x burner	43-134
<i>Source:</i> [31, EUROFER 10-7-18 2018]		

In addition to low-NO_x burners, further improvements in energy efficiency and environmental performance can be achieved by implementing new burner control systems. [[31, EUROFER 10-7-18 2018](#)]

Depending on the burner design, additional valves for air/fuel staging may be necessary. In the case of flameless burners, a furnace temperature (walls) above the self-ignition value is required. Safety interlocks need to be considered. [[31, EUROFER 10-7-18 2018](#)]

Cross-media effects

No information provided.

Technical considerations relevant to applicability

Applicability may be restricted at existing plants by design and/or operational constraints.

Economics

Replacing existing burners with state-of-the-art low-NO_x burners may be avoided if combustion is optimised (by reducing the excess air). This also provides additional fuel and yields savings. [[3, EUROFER 2020](#)]

Driving force for implementation

- Reduction of NO_x emissions. [31, EUROFER 10-7-18 2018]
- Increased energy efficiency. [31, EUROFER 10-7-18 2018]

Example plants

Widely used in plants of the FMP data collection, e.g.:

- Liberty Speciality Steels - Stocksbridge Billet Mill Continuous Furnaces.
- Liberty Speciality Steels - Rotherham billet annealing / soaking pits.
- Liberty Speciality Steels - Brinsworth Strip Narrow Strip Mill Slab reheating furnace.
- ArcelorMittal - Fos-sur-Mer Hot Strip Mill reheating furnaces.
- ArcelorMittal - Asturias Wire Rod Mill reheating furnace.

Reference literature

[3, EUROFER 2020], [16, FMP TWG 2018], [23, Lecomte et al. 2017], [31, EUROFER 10-7-18 2018].

2.4.2.9 Selective catalytic reduction (SCR)**Description**

The SCR technique is based on the reduction of NO_x to nitrogen in a catalytic bed by reaction with urea or ammonia at an optimum operating temperature of around 300–450 °C. Several layers of catalyst may be applied. A higher NO_x reduction is achieved with the use of several catalyst layers.

Technical description

See Section 8.8.1.4 for a detailed technical description.

Achieved environmental benefits

Reduced NO_x emissions.

Environmental performance and operational data**Example: Tata Steel IJmuiden**

The SCR technique is applied both at the walking beam furnaces and at the pusher furnaces which produce about 5.5 million tonnes of hot rolled steel annually. Figure 2.83 depicts the configuration of the walking beam furnaces. Usually, the type of catalysts used is suitable to operate within the temperature range 270–450 °C. Short periods of temperatures up to 500 °C do not harm the catalyst. However, at the pusher furnaces, temperatures near the catalyst range from 300 °C to 550 °C (with an average of 75 % of the time above 520 °C) occur and therefore another type of catalyst is required to resist such temperatures. The abatement of NO_x emissions with this other catalyst is lower however (around 60 %). [25, EUROFER 2018]

To increase the NO_x abatement efficiency at the pusher furnaces, a combination of SCR and SNCR is used, resulting in an overall NO_x emissions reduction rate of about 75 %. [46, EUROFER 1999], [47, EUROFER 1999]

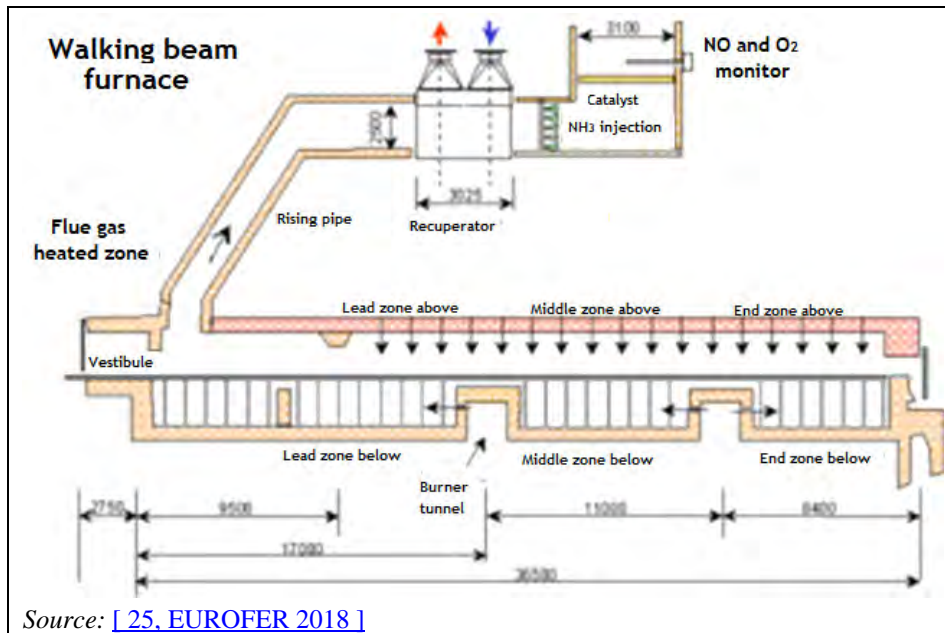


Figure 2.83: Schematic view of a walking beam furnace with De-NO_x

The NO_x emissions concentration depends on the composition of the fuel used. Usually, natural gas is used with a maximum of 60 % coke oven gas (COG). The efficiency of the NO_x reduction at the walking beam furnace is better than the pusher furnace. (See Figure 2.84.) [25, EUROFER 2018]

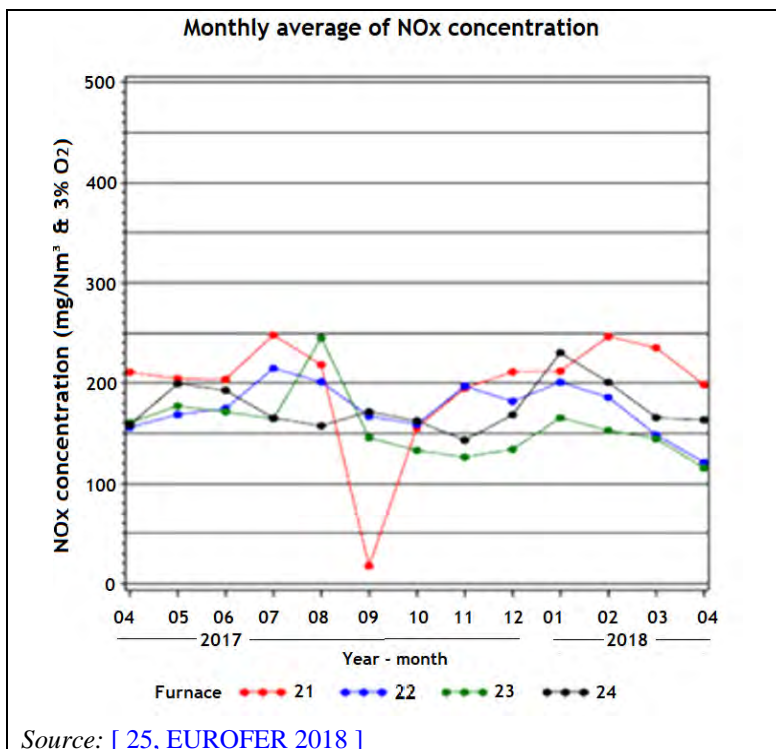


Figure 2.84: NO_x emissions concentrations at Tata Steel IJmuiden pusher furnaces (No 21 and 22) with SCR and SNCR and at the walking beam furnaces (No 23 and 24) with SCR

There are a certain number of aspects to consider when applying SCR in reheating furnaces:

- Some practical problems are likely to be encountered in the application of SCR in steel reheating/heat treatment furnaces as the production rate (and therefore thermal input) and temperature profiles are not steady state. To avoid either excessive NH₃ slip or excess NO_x in the stack, the ammonia injection rate would need to be controlled to match rapidly changing exhaust flow rates and NO_x concentrations. [48, ETSU 1996]
- SCR technology requires certain limits of temperature and volume flow, which might not be achieved by some plants. [49, DK, TWG member 1999]
- The required flue-gas temperature suitable for SCR may not be readily available. If the temperatures are too high, dilution air could be used, although furnace draughting may then not be acceptable. [48, ETSU 1996]
- In the case of regenerative burners, the efficiency of flue-gas heat recovery would be affected, unless the SCR could be incorporated midway in a regenerator bed (e.g. the bed would need to be split). [48, ETSU 1996]
- Many plants recover the waste heat of the exhaust gases for reasons of energy efficiency. The resulting temperature of the waste gas is in the range 150–210 °C and needs to be increased for the SCR catalyst to work properly. Indeed, when using regenerative or recuperative burners, air preheating takes place inside the actual burner. As such, waste gases need to be heated with additional fuel to secure that temperature reaches an interval for the SCR catalyst to work properly. Consequently, additional energy input would be necessary. [50, EUROFER 1999]
- With higher dust concentrations in the waste gas (e.g. if fuel oil is used as the energy source) dedusting measures would be required to protect the catalyst. [50, EUROFER 1999]
- In integrated steel plants, plant gases (BF gas, BOF gas or coke oven gas) are used as fuel. They usually contain only negligible traces of zinc or other metals, but these could still contaminate the surface of the catalyst and gradually reduce its efficiency and lifetime. [50, EUROFER 1999]
- A problem which can arise is the formation of acidic ammonium sulphate ((NH₄)₂SO₄) or bisulphate ((NH₄) HSO₄) particles by the reaction of excess ammonia carried over from the SCR reactor with SO₂ and SO₃ in the cooler flue-gases downstream. Deposition of these particles can cause fouling, erosion and corrosion of downstream equipment surfaces. The formation of ammonium sulphate is minimised by use of slightly sub-stoichiometric amounts of NH₃ (0.9–1.0 mole per mole of NO_x) to suppress carry-over. [51, Davies et al. 1995] [48, ETSU 1996]
- When implementing SCR in an existing plant, the additional pressure and temperature drop of the waste gas flow must be considered as it can affect recuperator units or additional downstream facilities, for example steam boilers. [25, EUROFER 2018]

Cross-media effects

- Use of ammonia gas (transport and storage can be hazardous and subject to stringent safety regulations).
- Risk of air pollution due to ammonia slip.
- Possible increase in energy consumption [52, Vercaemst 1999].
- Possible increase in waste; deactivated catalyst, which can be reprocessed by the manufacturer. This waste stream probably will be minimal. [52, Vercaemst 1999], [53, Oekopol 1999]

Technical considerations relevant to applicability

- An SCR system built as an independent unit requires significant space. When retrofitting existing plants, in certain cases this may result in constraints.
- Applicability to existing plants may be restricted by a lack of space.
- Applicability may be restricted in batch annealing due to the varying temperatures during the annealing cycle.

Economics

The cost efficiency at Tata Steel is EUR 2 per kg of NO_x reduced.

Driving force for implementation

Environmental legislation.

Example plants

Tata Steel IJmuiden (walking beam and pusher furnaces).

Plants in the data collection: 110 HR2, 175 HR.

Reference literature

[16, FMP TWG 2018], [25, EUROFER 2018], [46, EUROFER 1999] [47, EUROFER 1999], [48, ETSU 1996], [49, DK, TWG member 1999], [50, EUROFER 1999], [51, Davies et al. 1995], [52, Vercaemst 1999], [53, Oekopol 1999].

2.4.2.10 Selective non-catalytic reduction (SNCR)

Description

SNCR is based on the reduction of NO_x to nitrogen by reaction with ammonia or urea at a high temperature. The operating temperature window is maintained between 800 °C and 1 000 °C for optimal reaction.

Technical description

See Section 8.8.1.5 for a detailed technical description.

Achieved environmental benefits

Reduced NO_x emissions.

Environmental performance and operational data

Example: Outokumpu Stainless

At the hot strip mill for rolling stainless steel slabs to strip, there are two reheating furnaces (walking beam furnaces), each with a capacity of 100 t/h and using propane/butane gas as fuel. Furnace A, supplied by Stein Heurty, became operative in 1992, and Furnace B, supplied by Italimpianti, in 1996.

Because this is the plant's largest emission source of NO_x, action has been taken to reduce these emissions through the introduction of a SNCR installation. The installation comprises mainly a storage tank for ammonia (25 % water solution), pumps, pipes, injection lances, and a computerised measurement and control system, where ammonia is added to the exhaust gas of each furnace on the basis of continuous NO_x measurement.

The installation was put into continuous operation in October 1999 and was regulated during the autumn. Measurements in January 2000 gave the following results (NO_x measured as NO₂):

	NO _x content (mg/MJ fuel)	Reduction (%)	NO _x (mg/Nm ³)
Furnace A	74	70	205
Furnace B	62	30	172 (ammonia slip 5 mg/Nm ³)

The measurement results are averages of continuous measurements taken during 32 hours at Furnace A and 42 hours at Furnace B. They are considered normal and expected to remain at these levels in continuous operations.

The reason why the reduction is lower at Furnace B is that the nitrogen oxide content without ammonia is lower than in Furnace A.

Example: Tata Steel IJmuiden

At Tata Steel IJmuiden, the SCR technique is applied both in the walking beam furnaces and the pusher furnaces which produce about 5.5 million tonnes of hot rolled steel annually. The NO_x reduction rate for the walking beam furnace is about 80 %. Because of the high temperatures of the flue-gas (75 % above 520 °C), the reduction rate for the pusher furnaces would be much lower (30 %) and therefore since 2003 a combination of SCR and SNCR has been used. The overall reduction rate for the pusher furnace (SCR and SNCR) is about 75 %. [[46, EUROFER 1999](#)], [[47, EUROFER 1999](#)]

Other sources report an efficiency of NO_x removal by SNCR of typically 50–60 % with 20–30 ppm NH₃ slip [[48, ETSU 1996](#)], but even higher reductions of up to 85 % are reported in connection with ammonia injection in a natural-gas-fired regenerative burner. Others reported on the use of ammonia and urea injected into the flue of a burner (operating at 900 °C air preheat) burning a mixture of blast furnace and coke oven gases. For both reagents, the maximum reduction was of the order of 80 %. These data derive from test furnaces not exceeding 600 kWth, which in this case was a 1/3 scale version of a soaking pit furnace. [[51, Davies et al. 1995](#)]

The temperature window for SNCR is about 850–1 100 °C (depending on the reagent). For those regenerative systems which have furnace temperatures well in excess of 1 000 °C, the appropriate SNCR temperature range is likely to be found within the regenerator bed, which may discourage the use of the method. Control systems would be complicated if there were a need to ‘follow’ a temperature window which can change its location within the furnace/burner as thermal inputs and production rates are altered. [[4, EUROFER 1998](#)], [[51, Davies et al. 1995](#)]

When implementing this technique in an existing plant, the additional pressure and temperature drop of the waste gas flow must be taken into consideration. This can affect recuperator units or additional downstream facilities, for example steam boilers. [[25, EUROFER 2018](#)]

Cross-media effects

- Use of ammonia gas (transport and storage can be hazardous and subject to stringent safety regulations).
- Risk of air pollution due to ammonia slip.
- A potential drawback of the SNCR technique is the formation of ammonium sulphate by the carry-over of excess NH₃. The use of clean gaseous fuels such as natural gas in conjunction with SNCR should avoid the reported problems of adhesive and corrosive compounds that can otherwise occur. This may not be the case with sulphur-containing steelworks gases. [[51, Davies et al. 1995](#)]
- Energy consumption to heat the exhaust gases to the operating temperature for SNCR. [[25, EUROFER 2018](#)]

Technical considerations relevant to applicability [[25, EUROFER 2018](#)]

- Applicability to existing plants may be restricted by the optimum temperature window and the residence time needed for the reaction.
- Applicability may be restricted in batch annealing due to the varying temperatures during the annealing cycle.

Economics

The cost efficiency at Tata Steel walking beam furnaces is EUR 2 kg of NO_x reduced.

Driving force for implementation

Environmental legislation.

Example plants

Outokumpu Stainless 266 HR, walking beam furnaces.

Plants in the data collection: 110 HR2, 238 HR.

Reference literature

[4, EUROFER 1998], [16, FMP TWG 2018], [25, EUROFER 2018], [46, EUROFER 1999], [47, EUROFER 1999], [48, ETSU 1996], [51, Davies et al. 1995], [54, EUROFER 1999].

2.4.2.11 Flue-gas recirculation (FGR)

Description

Recirculation (external) of part of the flue-gas to the combustion chamber to replace part of the fresh combustion air, with the dual effect of limiting the O₂ content for nitrogen oxidation and reducing the combustion temperature, thus limiting NO_x generation.

Technical description

See Section 8.8.2.9 for a detailed technical description.

Achieved environmental benefits

Reduced NO_x emissions.

Environmental performance and operational data

- For a COG-fired steel slab reheater with a capacity of at least 140 t/h, NO_x reductions of 51.4 %, 69.4 % and 79.8 % (from a base level of 657 mg/m³) for 10 %, 20 % and 30 % FGR respectively are reported. [48, ETSU 1996]
- A potential decrease of furnace performance and therefore a lower throughput rate must be considered, especially when reaching the operational limit of the furnace. [25, EUROFER 2018]
- In some cases, a potential loss of flame stability and burner shutdown may occur. [25, EUROFER 2018]
- The burner capacity is reduced and the burner has to be downrated to compensate when replacing some of the combustion air with low-oxygen flue-gases. [25, EUROFER 2018]
- Potentially difficult to control in cases where composition and hence waste gas volumes are variable (e.g. on integrated sites where mixed plant gases are used).

Cross-media effects

- Potential increase in fuel consumption (as long as waste gas flow and temperature are not affected by FGR, the combustion efficiency and fuel consumption will remain the same, but this implies an increase of the air preheat temperature).
- Increases in fuel consumption (and hence CO₂ emissions) for different burner designs range from 1.1 % to 9.9 % (FGR ranging from 10 % to 50 %). [48, ETSU 1996]
- Higher emissions of carbon monoxide and unburnt hydrocarbons. [25, EUROFER 2018]
- Increased water vapour content in the combustion products can increase scaling of the steel, thus increasing the need for descaling and increasing the related emissions to air and waste generated by it. [25, EUROFER 2018]

Technical considerations relevant to applicability

Applicability to existing plants may be restricted by a lack of space.

Economics

For the retrofitting of FGR, no costs are provided.

FGR is often applied with other primary measures such as low-NO_x burners, so it is difficult to estimate the costs of FGR alone.

Driving force for implementation

Environmental legislation.

Example plants

Plants in the data collection: 113 HR2, 138 HR1, 156 HR1, 203 HR, 203 HR2, 267 HR, 271 HR1, 272 HR1.

Reference literature

[16, FMP TWG 2018], [25, EUROFER 2018], [48, ETSU 1996].

2.4.2.12 Optimised skid design to reduce skid marks**Description**

The design of skids in reheating furnaces is optimised to minimise skid marks (e.g. colder zones on the reheated feedstock at skid location) on the feedstock using skid riders, skid shifting or a skid mark compensation device.

Technical description

Reheating furnaces are used to reheat steel slabs before hot rolling. Inside reheating furnaces, steel slabs are supported by water-cooled refractory-coated pipes called skids. The skids can to a certain extent block thermal radiation resulting in the apparition of skid marks on the feedstock. With skid marks, the temperature of the steel slab is not uniform at the exit of the furnace which has detrimental effects on the final quality of the product after hot rolling. Skids are used generally both in pusher-type and walking beam furnaces. [41, EUROFER 2020]

In order to minimise skid marks on steel slabs, four techniques are usually employed:

Skid mark compensation (SMC) device

The slabs heated in a pusher-type furnace lean on water-cooled supporting pipes which cause local underheating (skid marks) on the bottom side of the feedstock and must be compensated for during the residence time in the soaking hearth to avoid thickness variations of the finished product. The soaking time can be reduced if the skid marks are reheated by application of suitable methods, e.g. local inductive heating (skid mark compensation device). Losses due to the cooling system and the hearth wall are almost constant over time, regardless of whether the furnace is operated under full load or partial load.

Furnace skid riders

An additional measure to reduce the formation of skid marks is the use of the so-called skid riders. These are fixtures for the water-cooled furnace rails made from special material (metal alloy or ceramics), which reduce temperature dissipation (See Figure 2.85).



Source: [41, EUROFER 2020]

Figure 2.85: Skid riders design in a reheating furnace before hot rolling

Minimised shadowing skids

Another measure to reduce the formation of skid marks is to optimise the shape of the skid itself in order to decrease the shadowing effect observed when heating the feedstock from the bottom side of the furnace. The usual practice is to replace the single pipe design of the water-cooled skid by a double-pipes design with significant lower diameter. This design is also named tandem horizontal skid. [41, EUROFER 2020]

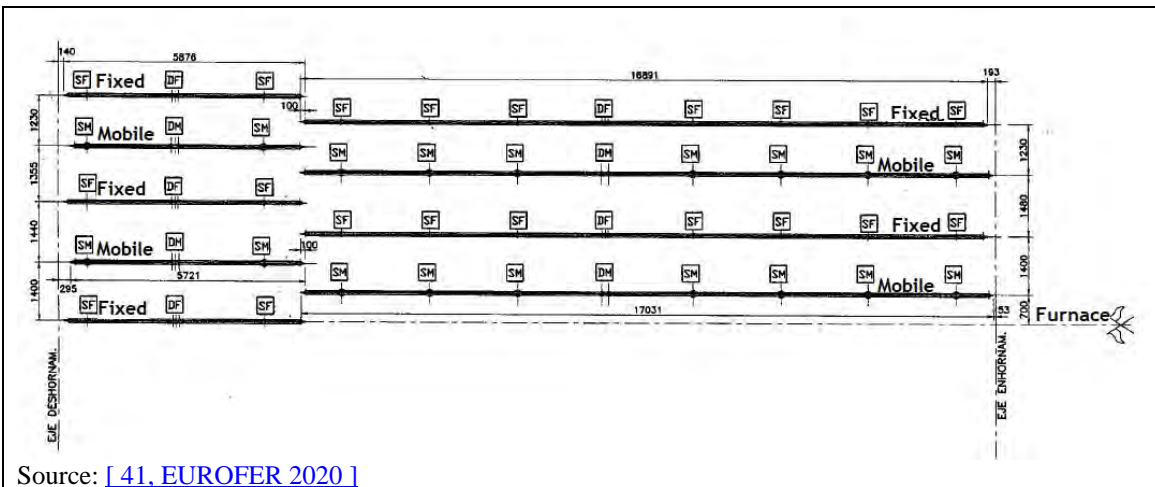


Source: [41, EUROFER 2020]

Figure 2.86: Double-pipes skid design for reheating furnaces

Skid shifting

In modern walking beam furnaces, the material supporting skids are not straight all along the furnace. Mainly the last section of skids, near the furnace exit side, is shifted with an offset designed to distribute and therefore to decrease the skid marks.



Source: [41, EUROFER 2020]

Figure 2.87: Top view of the skids distribution in a reheating furnace (the right part of the schematic is the furnace entry while the left part is the furnace exit)

Achieved environmental benefits

- The reduction of the residence time on the hearth and, consequently, of the throughput time, results in energy savings in the case of SMC. But it was also reported that SMC requires high energy input for inductive heating. [14, Hot Rolling Shadow Group 2000]
- The use of skid riders and/or minimised shadowing skids may lead to a slight reduction of the average temperature of the feedstock at the furnace exit combined with an increased throughput. These two effects contribute to energy savings. Skid shifting has a similar effect but with higher impact on furnace productivity and energy savings. [41, EUROFER 2020]

Environmental performance and operational data

The reported reductions for skid shifting, skidmark compensation or furnace skid riders were 1 % for energy consumption and 1 % for NO_x emissions. [4, EUROFER 1998]

Cross-media effects

SMC requires high energy input for inductive heating. [\[14, Hot Rolling Shadow Group 2000 \]](#)

Technical considerations relevant to applicability

- Furnace skid riders, minimised shadowing skids and skid shifting are only applicable to new installations as they have to be considered at the design stage.
- Skid mark compensation device: Generally, there are no technical restrictions to the applicability of this technique.

Economics

No information provided.

Driving force for implementation

- Increased energy efficiency.
- Improved product quality.

Example plants

Widely used.

Reference literature

[\[4, EUROFER 1998 \]](#), [\[14, Hot Rolling Shadow Group 2000 \]](#), [\[41, EUROFER 2020 \]](#).

2.4.2.13 Reduction of energy loss through feedstock transportation device**Description**

The number of feedstock-supporting structures inside the furnace (e.g. beams, skids) are minimised and suitable insulation is used to reduce the heat losses from water cooling of the structures in continuous reheating furnaces.

Technical description

In reheating furnaces, water cooling is used to protect some components and maintain their physical strength; examples include doors, lintels and the stock transport mechanism or support system. Water-cooled components represent a significant source of energy losses. In particular, the loss through stock transport systems in continuous (walking beam) furnaces can account for 6–12 % of the fuel input under typical operating conditions. Close to the end of a furnace operating campaign, when insulation of the cooled components begins to degrade, the loss can be as high as 20–25 %. [\[14, Hot Rolling Shadow Group 2000 \]](#), [\[37, ETSU 1993 \]](#)

Losses from feedstock-supporting structures can be minimised at the design stage by optimising/reducing the number of cooled beams and supports and by using suitable insulation. [\[37, ETSU 1993 \]](#)

Achieved environmental benefits

A reduction in water cooling losses of 26.7 GJ/h (equivalent to a fuel saving of 44.5 GJ/h) was reported. [\[37, ETSU 1993 \]](#)

Environmental performance and operational data

No information provided.

Cross-media effects

- 46 % reduction in water use. [\[37, ETSU 1993 \]](#)
- Reduced energy consumption of pusher mechanism. [\[37, ETSU 1993 \]](#)
- Reduced skid marks, improved quality. [\[37, ETSU 1993 \]](#)

Technical considerations relevant to applicability

- Only applicable to new plants and major plant upgrades.
- For existing furnaces, optimisation can be done during refractory maintenance. [14, Hot Rolling Shadow Group 2000]

Economics

No information provided.

Driving force for implementation

Increased energy efficiency.

Example plants

Plants from the data collection: 14 HR, 55 HR, 87 HR, 94 HR2, 99 HR2, 100 HR, 106 HR, 110 HR1, 110 HR2, 121 HR, 127 HR, 133 HR, 152 HR, 157 HR1, 158 HR, 172 HR, 174 HR, 199 HR, 203 HR, 230 HR, 265 HR, 270 HR, 275 HR.

Reference literature

[14, Hot Rolling Shadow Group 2000], [16, FMP TWG 2018], [37, ETSU 1993].

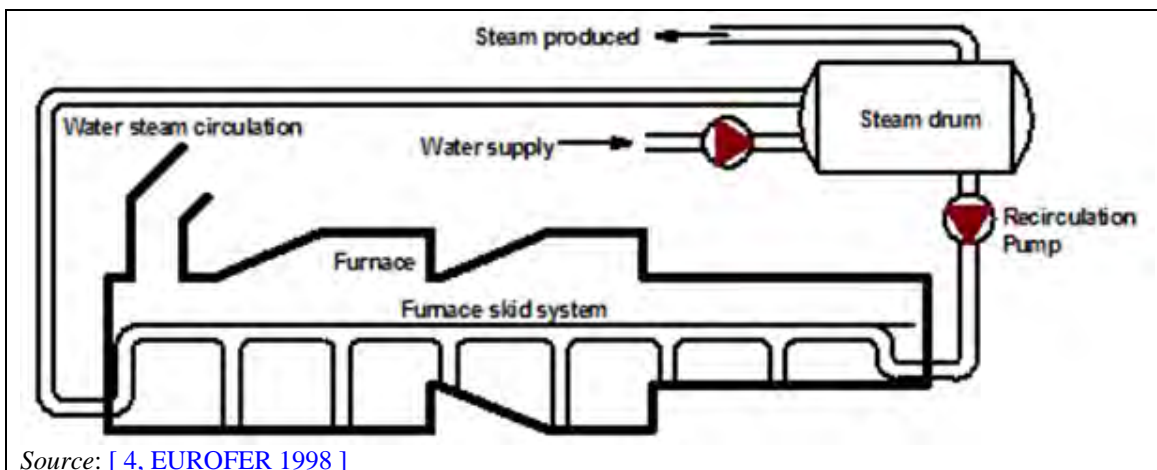
2.4.2.14 Heat recovery from skids cooling

Description

Steam produced when cooling the skids supporting the feedstock in the reheating furnaces is extracted and used in other processes of the plant.

Technical description

Skid cooling energy losses can be used to generate steam. A closed forced cooling circuit, which circulates a mixture of approximately 95 % water and 5 % saturated steam, can be installed in reheating furnaces. Steam produced by cooling the supporting beams (skids) of rolling stock is extracted from the circuit and fed to other consumers for further use. [4, EUROFER 1998]



Source: [4, EUROFER 1998]

Figure 2.88: Typical schematic of evaporative furnace skid cooling

Achieved environmental benefits

Efficient energy use saves resources as no fuel is consumed at other stages for producing the steam and emissions are reduced.

Environmental performance and operational data

Example: ArcelorMittal Eisenhüttenstad. [[27, Van Roosbroeck 1999](#)]

- average working pressure in the boiler: 23 bar;
- average temperature of cooling water: 222 °C (at 23 bar);
- possible steam production for the turbine: 10–41 t/h (depending on the situation of the refractory material and the working conditions of the furnace);
- generator capacity: 4.16 MW;
- steam production (cold charging): 18 t/h;
- steam production (hot charging): 22 t/h;
- recovered energy: n.a.

Cross-media effects

No negative effects on other media are known.

Technical considerations relevant to applicability

Applicability to existing plants may be restricted by a lack of space and/or by a suitable steam demand.

Economics

Reported general reduction potential and cost data are given in the following table.

Table 2.22: Typically achievable reductions and cost data for evaporative furnace skid cooling

Evaporative furnace skid cooling	Reduction ¹ [%]	
	NO _x	Energy ²
	7	7
Notes: Source: [4, EUROFER 1998]. Basis is a furnace with a yearly capacity of 1.5 Mt fired with natural gas with standard burners and without air preheat. Investment costs can be site-specific (available room, layout of the existing furnace, number of side and bottom burners).		
¹ Evaporative furnace skid cooling has a negligible effect when combined with recuperators or with regenerative systems.		
² The energy reduction in terms of percentage has an equal effect on the reduction in SO ₂ , CO and CO ₂ emissions.		

Only a marginal effect can be expected from evaporative furnace skid cooling when it is combined with good insulation of the skids.

Driving force for implementation

Increased energy efficiency.

Example plants

SSAB, ArcelorMittal Eisenhüttenstad.

Reference literature

[[4, EUROFER 1998](#)], [[27, Van Roosbroeck 1999](#)], [[37, ETSU 1993](#)].

2.4.2.15 Heat conservation during transfer of feedstock**Description**

Insulated covers are used between continuous caster and the reheating furnace, and between the roughing mill and the finishing mill.

Technical description

Heat conservation between the continuous caster and the reheating furnace

Hot boxes or insulated covers are used to promote heat retention in the steel and to provide a link between the source of hot stock and the furnace. Semi-finished products, which cannot be charged immediately (because of programme coordination and for bridging gaps caused by interruptions), are stored in this unheated, heat-insulated box instead of being stored in open stockyards. Heat losses of the slabs are reduced and the charge temperature is maintained at a high level. On average, the storage time for slabs is 8 hours. The temperature of insulated stored slabs is approximately 220 °C higher than that of open stored slabs. [4, EUROFER 1998], [37, ETSU 1993]

Heat conservation between the roughing mill and the finishing mill

To minimise temperature loss in a bar while it is conveyed from the roughing mill to the finishing mill and to decrease the temperature difference of the head and tail ends on entering the finishing train, the transfer roller table can be equipped with heat covers. These are insulated covers applied to the conveyor. For those sizes where the rolled products reach the limit of capacity of the rolling train, this equipment achieves lower rolling loads. However, a potentially higher risk of surface defects (rolled-in scale) and potential damage caused by curled transfer bars was reported for heat retention shields.

Achieved environmental benefits

- Reduced energy consumption in reheating.
- Thermal covers for the transport of slabs between a continuous caster and a reheating furnace can save about 0.33 GJ/t. [10, Rentz et al. 1998]
- Reduced temperature loss.

Environmental performance and operational data

Heat conservation between the continuous caster and the reheating furnace

An investigation into potential measures to increase the charging temperature of continuous cast slabs to a heating furnace was done using numerical modelling (Figure 2.89). The results based on computer simulation and measurements for that installation showed that the core temperature of slab immediately after casting was about 950 °C. On the way to the stockyard of the hot rolling mill the slabs cooled down to 750 °C: during the storage time of 24 hours the temperature of the slabs dropped further, leaving a remaining charging temperature in the heating furnace of about 350 °C. By optimising the synchronisation of the continuous caster and the rolling schedule, the storage time could be reduced to a third. Additionally, the slabs were covered with thermal covers with a 50 mm mineral wool lining. It was proven that during an 8-hour storage period, starting from 750 °C, a charging temperature of 700 °C could be maintained. Compared to the old charging practice (350 °C), this represented an additional energy input to the furnace of 0.26 GJ/t, resulting half from the shorter storage time and half from the thermal insulation. [35, Münch 1997]

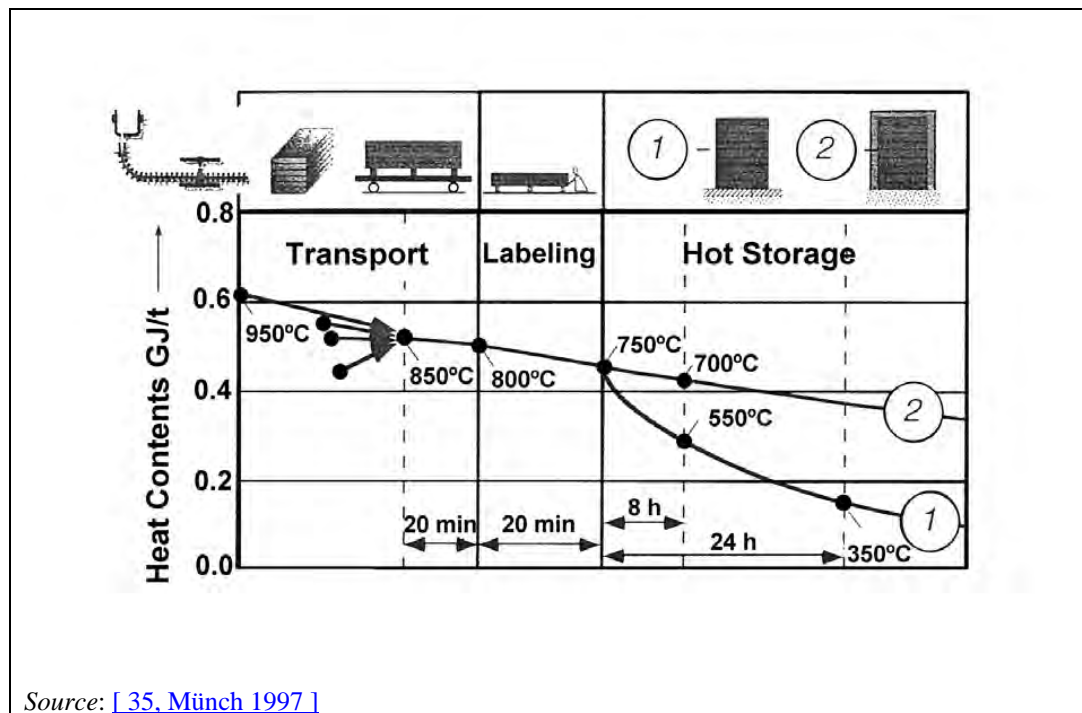


Figure 2.89: Modified storage to increase charge temperature

Heat conservation between the roughing mill and the finishing mill

Heat shields on transfer tables involve high maintenance costs as the shields are easily damaged by cobbles. [14, Hot Rolling Shadow Group 2000]

Cross-media effects

No negative effects on other media are known.

Technical considerations relevant to applicability

Generally applicable within the limitations of the plant layout.

Economics

- Return on investment was 1 year at VA Stahl Linz. [28, AT, TWG member 1999]
- Investment costs of EUR 2 million were reported by Voest. [27, Van Roosbroeck 1999]

Driving force for implementation

- Increased furnace and rolling mill capacity.
- Increased hot charging rate in connection with CAQC. [28, AT, TWG member 1999]
- Improved yield.

Example plants

Heat conservation between the continuous caster and the reheating furnace

- VA Stahl Linz, (maximum 5 000 t), Austria. [27, Van Roosbroeck 1999]
- HADEED, Saudi Arabia. [28, AT, TWG member 1999]
- Plants from the data collection: 08-09 HR, 11 HR, 38 HR, 55 HR, 100 HR, 110 HR2, 139 HR, 152 HR, 158 HR, 174 HR, 175 HR, 178 HR, 202 HR, 222 HR, 246 HR2, 265 HR, 287 HR, 288 HR.

Heat conservation between the roughing mill and the finishing mill

Plants from the data collection: 12 HR, 38 HR, 66 HR, 88 HR, 94 HR1, 99 HR2, 100 HR, 106 HR, 121 HR, 126 HR, 127 HR, 174 HR, 178 HR, 196 HR, 197 HR, 222 HR, 230 HR, 231 HR, 241 HR1, 266 HR, 288 HR.

Reference literature

[4, EUROFER 1998], [10, Rentz et al. 1998], [14, Hot Rolling Shadow Group 2000], [16, FMP TWG 2018], [27, Van Roosbroeck 1999], [28, AT, TWG member 1999], [35, Münch 1997], [37, ETSU 1993].

2.4.2.16 Hot/direct charging

Description

Continuous-cast steel products are directly charged hot into the reheating furnaces or directly transferred to the rolling mill in hot conditions.

Technical description

Contrary to the conventional process (storage and cooling of the material), the residual heat from the continuous cast slabs, blooms, beam blanks or billets is utilised by charging them directly (with their residual heat content) into the heating furnaces. Hot charging refers to charging temperatures of 300–600 °C. Direct charging refers to temperatures of 600–850 °C. These techniques can only be applied if the surface quality is good enough that cooling and scarfing is not required and if the manufacturing programmes of the steel-making plant and the hot rolling mill can be adequately tuned. Control computers are used to coordinate the production of both departments according to customers' orders and to prepare the rolling schedules.

Figure 2.90 presents a possible material flow in a plant allowing both cold charging and warm (direct) or hot charging. An optimised production planning and control system to synchronise the production schedules of a steelworks and a rolling mill can achieve a direct charging share of over 60 % at about 800 °C.

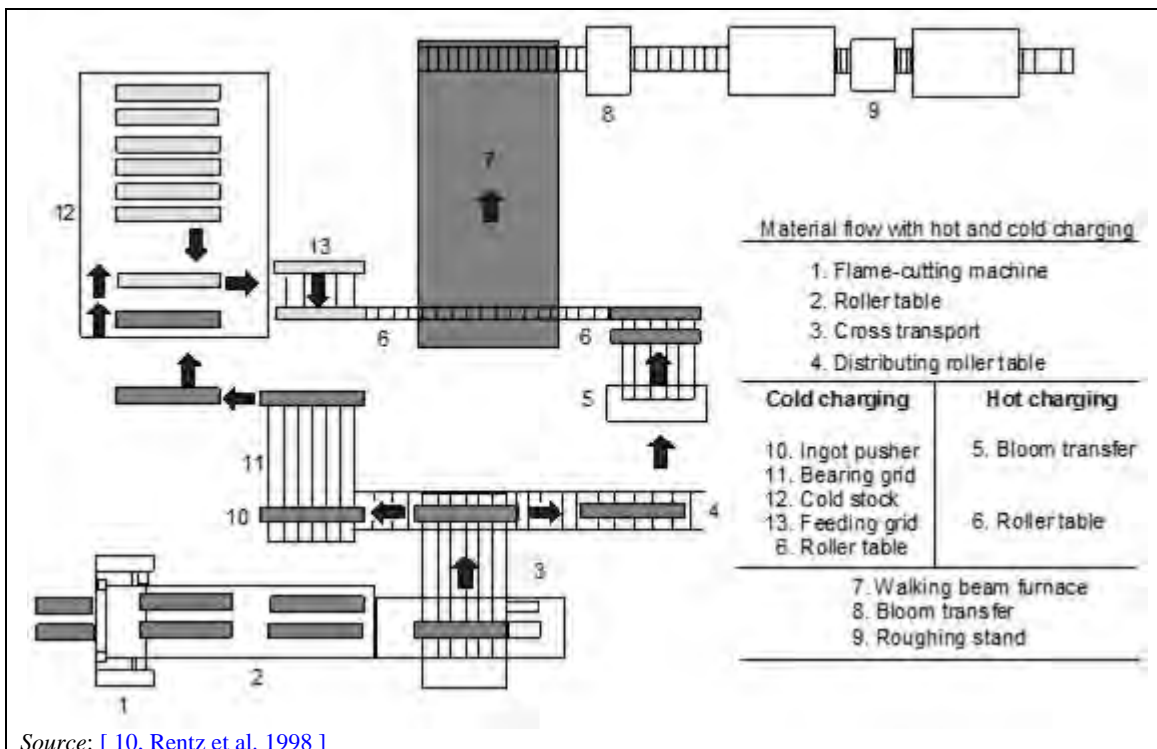


Figure 2.90: Material flow - cold versus hot charging

Achieved environmental benefits

- Reduction in energy consumption (fuel savings).
- Reduction in SO₂, CO and CO₂ emissions.

Environmental performance and operational data

Table 2.23 illustrates the influence of hot charging on energy consumption and production time for hot charging. In the examples shown, the production capacity was increased by 10 % for a hot charging temperature of 400 °C and by 25 % for a charging temperature of 700 °C.

Table 2.23: Effect of hot charging on fuel consumption and residence time

Charging Temperature	20 °C	400 °C	700 °C
Specific energy consumption (fuel)	1.55 GJ/t	1.25 GJ/t	0.94 GJ/t
Percentage Reduction	0 %	19 %	39 %
Heat to steel	0.80 GJ/t	0.56 GJ/t	0.37 GJ/t
Residence time in furnace ¹	100 min	90 min	75 min

¹ Example based on: billets, mild steel, top-fired pusher furnace, discharge temperature 1 200 °C.
Source: [11, ETSU - b 1993]

Examples

ArcelorMittal Eisenhüttenstadt hot charging of slabs. [3, EUROFER 2020]

- percentage of hot charging: 15 % (2019);
- average charging temperature of slabs: 750 °C;
- energy saving: 0.6 GJ/t when using direct charging (0.1 GJ/t on the average of total production).

Liberty Steel, Ostrawa: almost 100 % direct charging at 850 °C. [3, EUROFER 2020]

- Specific energy consumption: 0.85 GJ/t.

Imatra Steel, Imatra hot charging of blooms

- engineering steel grades, billets / heavy bars 74 / 26 %;
- percentage of charging via hot route 91–93 %;
- direct hot charging 700–900 °C;
- charging via hot buffer (natural gas fired) 700 °C;
- soaking temperature 1 250–1 290 °C;
- specific energy consumption: 0.87 GJ/t (average for production 1998 (98 % natural gas + 2 % electricity) including hot buffer, cold charging, weekends and light-up energy).

Hot buffer is used:

- to eliminate effects of short stoppages in rolling mill;
- to balance the production speed difference when rolling bars (the casting speed cannot be lowered to match the speed of the old rolling mill);
- for slow preheating of cold blooms at weekends.

Cross-media effects

- Reduced stock residence time in the furnace.
- Higher production rates (e.g. 10–25 %).
- Improved yields and product quality due to reduced scaling and decarburisation.
- Waste reduction in the following processes, e.g. descaling.
- Temperature of exhaust gas may increase. [11, ETSU - b 1993]

Technical considerations relevant to applicability

Only applicable to plants adjacent to continuous casting and within the limitations of plant layout and product specifications.

Economics

No information provided.

Driving force for implementation

Reduced energy consumption.

Example plants

- Hot strip mills: 37 HR, 94 HR, 97 HR, 106 HR, 110 HR2, 118 HR, 121 HR, 222 HR, 265 HR.
- Beam mills: 91 HR, 99 HR2, 108 HR1, 108 HR2, 109 HR.
- Rods/wire rod mills: 140 HR, 202 HR, 288 HR.
- Bar mills: 14 HR, 66 HR, 99 HR, 101 HR, 139 HR, 140 HR, 202 HR, 203 HR, 231 HR, 248 HR, 273 HR.

Reference literature

[[3, EUROFER 2020](#)], [[4, EUROFER 1998](#)], [[11, ETSU - b 1993](#)], [[16, FMP TWG 2018](#)], [[55, Kirk 1995](#)], [[56, Hendricks et al. 1998](#)].

2.4.2.17 Near-net-shape casting for thin slabs followed by rolling

Description

Thin slabs are produced by combining casting and rolling into one process step. The need to reheat the feedstock before rolling and the number of rolling passes is reduced.

Technical description

Near-net-shape casting is a process of casting metal to a form close to that required for the finished product. For production of flat products, near-net-shape casting consists of applying a series of advanced continuous thin slab casting techniques in which the thickness of the produced slab is reduced as far as possible to the required end product shape. Overall, near-net-shape casting integrates the casting and hot rolling of steel into one process step, thereby reducing the need to reheat the steel before rolling it. [57, Worrell et al. 2010]

For the production of flat products, liquid steel is generally cast into slabs in a thickness range of 150-300mm. Thin slabs (range 15-90 mm) are produced by combining casting and rolling into one process step. It is a step forward to simplify the flowsheet of production. The need to reheat the feedstock before rolling and the number of rolling passes are considerably reduced, as is the overall length of the rolling mill. The basic concept is the achievement of optimum cost-efficiency both in terms of capital and operational expenditure. [3, EUROFER 2020]

The technical solutions available differ mainly in the thickness of the slabs, ranging from 15 mm up to 90 mm (conventional thickness ranges 150–300 mm), in the reheat technique and the linkage between caster and hot rolling mill. A typical temperature evolution for thin slab casting followed by rolling is shown in Figure 2.91.

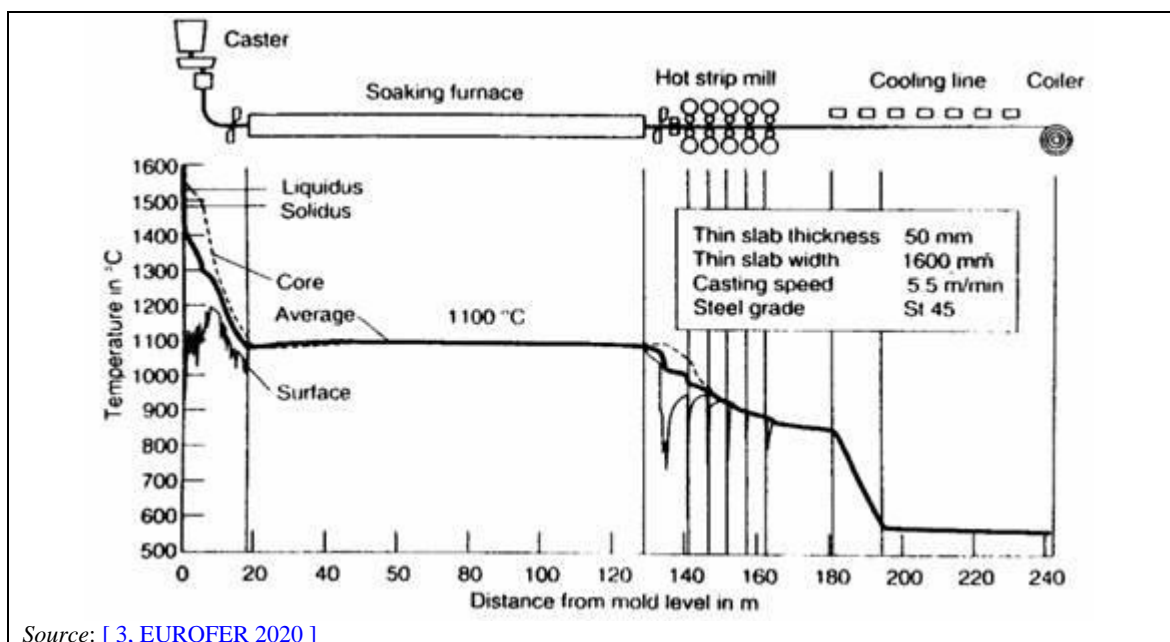


Figure 2.91: Typical temperature evolution during thin slab casting followed by rolling

Available thin slab casting techniques include the following:

- **Compact Strip Production (CSP):** using funnel-type moulds with a casting thickness of approximately 50 mm. The caster is coupled with a pendulum shear and tunnel furnace. Up to three strands can be installed in parallel, feeding one finishing mill via a thin slab transfer device. The finishing mill (comprising 5 to 7 stands) is followed by strip cooling and coilers. Strip thickness ranges from 1 mm up to 15 mm and from 800 mm up to 1 850 mm in width. One strand CSP has a capacity of up to 1.5 Mt/y, two strands up to 3 Mt/y and 3 strands up to 4 Mt/y. [3, EUROFER 2020]

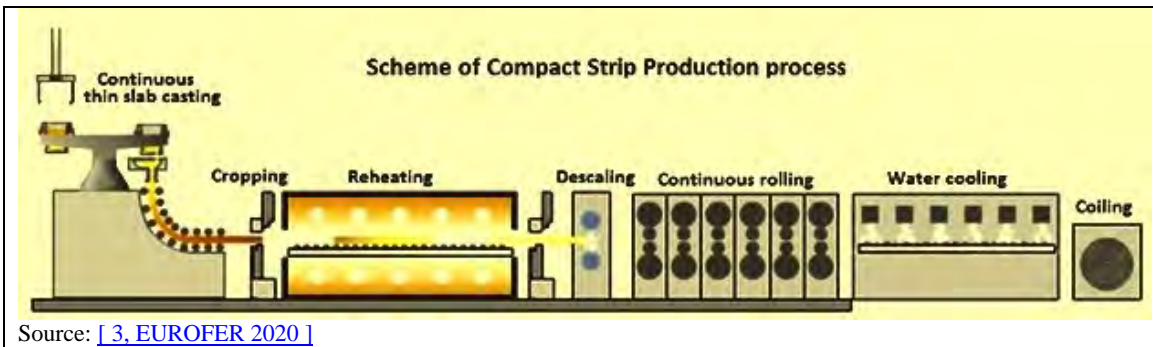


Figure 2.92: Schematic of the Compact Strip Production process (CSP)

- Inline Strip Production (ISP):** the cast strand of about 60 mm thickness undergoes a soft reduction (on liquid core) with rolls below the mould, followed by a three stand roughing mill, shaping of the solidified strand creating a slab thickness of about 15-20 mm. The thin slab is cut to length and reheated in a compact induction furnace combined with coil box, followed by the finishing mill. The strip thickness range is 1-6 mm with a maximum width of 1 300 mm. The maximum production is around 1.2-1.5 Mt/y. [3, EUROFER 2020]

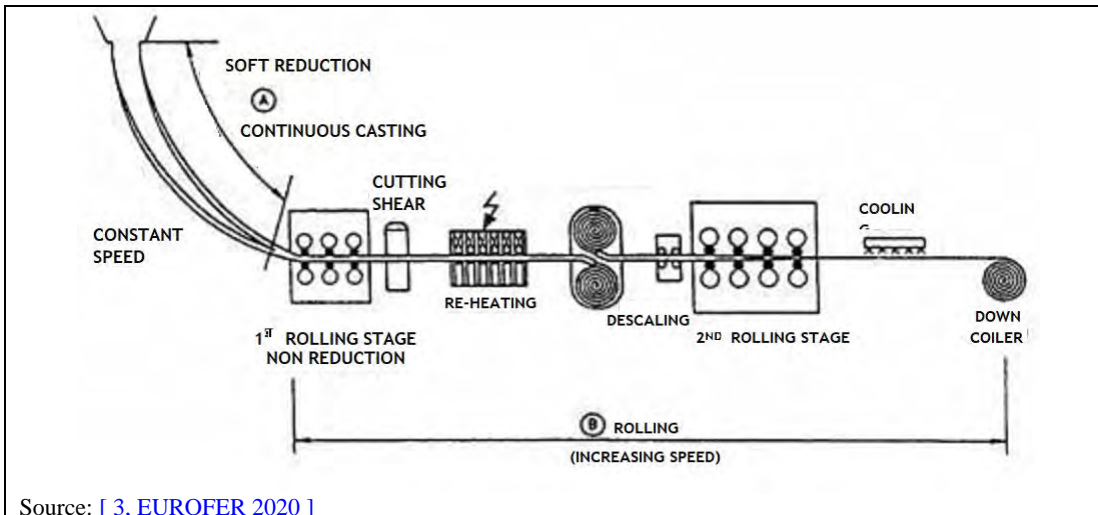
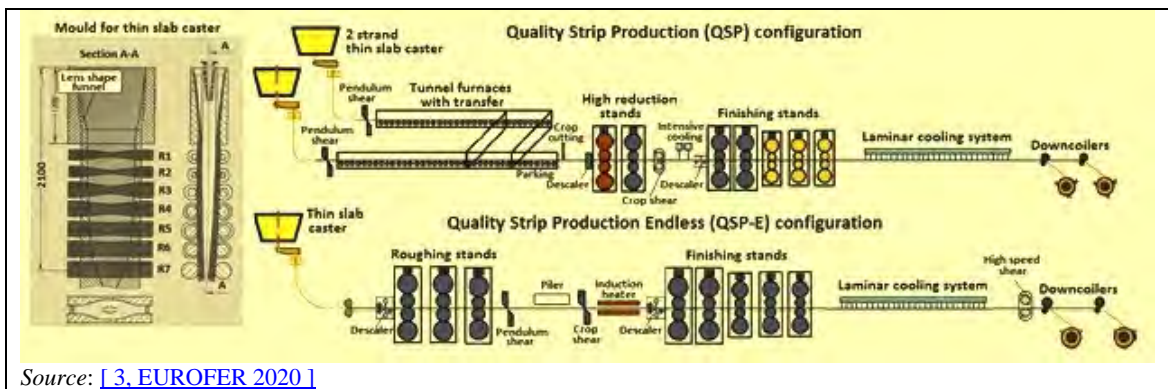


Figure 2.93: Schematic of the Inline Strip Production process (ISP)

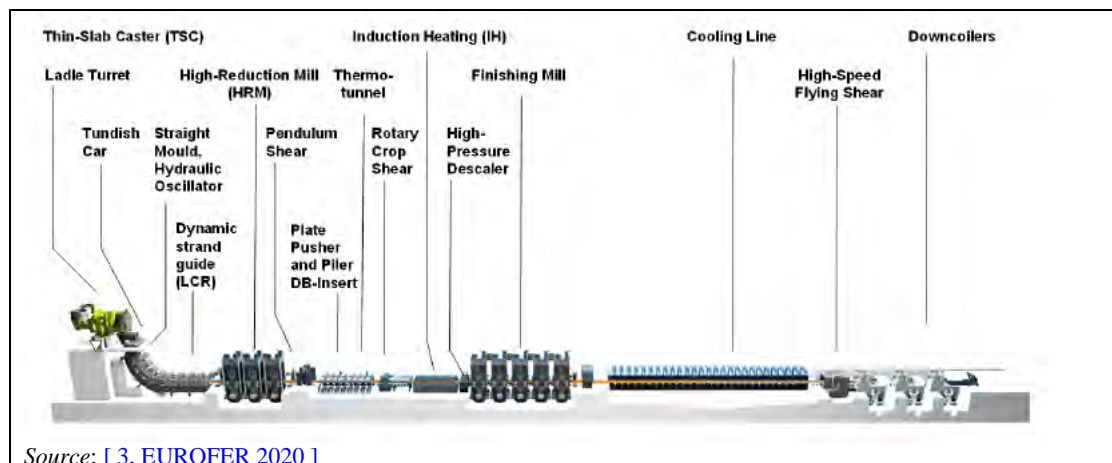
- Continuous Thin Slab Casting and Rolling (CONROLL):** using straight parallel moulds with a casting thickness of 70–80 mm. The caster is connected to the finishing mill (up to seven stands) via a roller hearth reheating furnace. The final thickness is in the range of 2-20 mm. The design is especially suitable for stainless steel, but other high-alloy, high-strength low-alloy (HSLA) and silicon steels can also be produced. [3, EUROFER 2020]
- Flexible Thin Slab Casting and Rolling (FTSC-FTSR):** The cast strand thickness (range 65-90 mm) is followed by rolling composed of a roughing mill (1-3 stands) and a finishing mill (up to 6 stands). The caster operates at very high speed in order to increase productivity. Proven capacity is 2 Mt/y with one strand and 3 Mt/y with two strands. More recently, FTSC developed two different layout concepts named Quality Strip Production (QSP) and Quality Strip Production Endless (QSP-E). In QSP, a plant with one or two casters is connected to the rolling mill through tunnel furnace(s) able to guarantee sufficient buffer time in case of a stoppage at the rolling mill. This design enables wide flexibility in terms of product mix: ultra-low carbon, HSLA, silicon steel. In QSP-E, casting is limited to one strand, with the possibility of endless rolling. The plant is extremely compact, especially dedicated to the production of ultra thin specifications down to 0.8 mm. [3, EUROFER 2020]



Source: [3, EUROFER 2020]

Figure 2.94: Configurations of the Quality Strip Production (QSP) and Quality Strip Production Endless (QSP-E) concepts

- Endless Strip Production (ESP):** With a 90 mm caster mould and soft-reduction to 70 mm, the slab is coupled with a 3-stand roughing mill, followed by an induction heater and a finishing mill. With a rotary crop shear located just before induction heating and high-speed flying shear in front of the coilers, ESP enables both semi-endless and fully endless rolling, with a minimum thickness of 0.8 mm. The configuration is extremely compact (190 m in total), optimising energy consumption both for reheating and rolling. The production capacity is 1.7 Mt/y for 1 300 mm width design and 2.5 Mt/y for 1 600 mm width. Overall, the concepts of ESP and QSP-E are very similar. [3, EUROFER 2020]



Source: [3, EUROFER 2020]

Figure 2.95: Schematic view of the Endless Strip Production process (ESP)

Achieved environmental benefits

- Reduced energy consumption both for reheating and hot rolling.
- Yield improvement.
- Reduced water consumption.
- Suppression of the cold rolling process in case of very thin specifications (range 0.8-1.2 mm).

Environmental performance and operational data

The production of 1–3 mm thick strip by conventional slab casting - with a charging temperature for the furnace of 20 °C and discharge at 1 200 °C - requires a specific energy consumption of 1.67 GJ/t. A thin slab casting line - with a charging temperature for the furnace of 960 °C and discharge at 1 150 °C - has a specific energy consumption of 0.50 GJ/t. Most of the steel grades can be produced with thin slab casting followed by rolling, with some limitations for automotive exposed parts and packaging products. [3, EUROFER 2020]

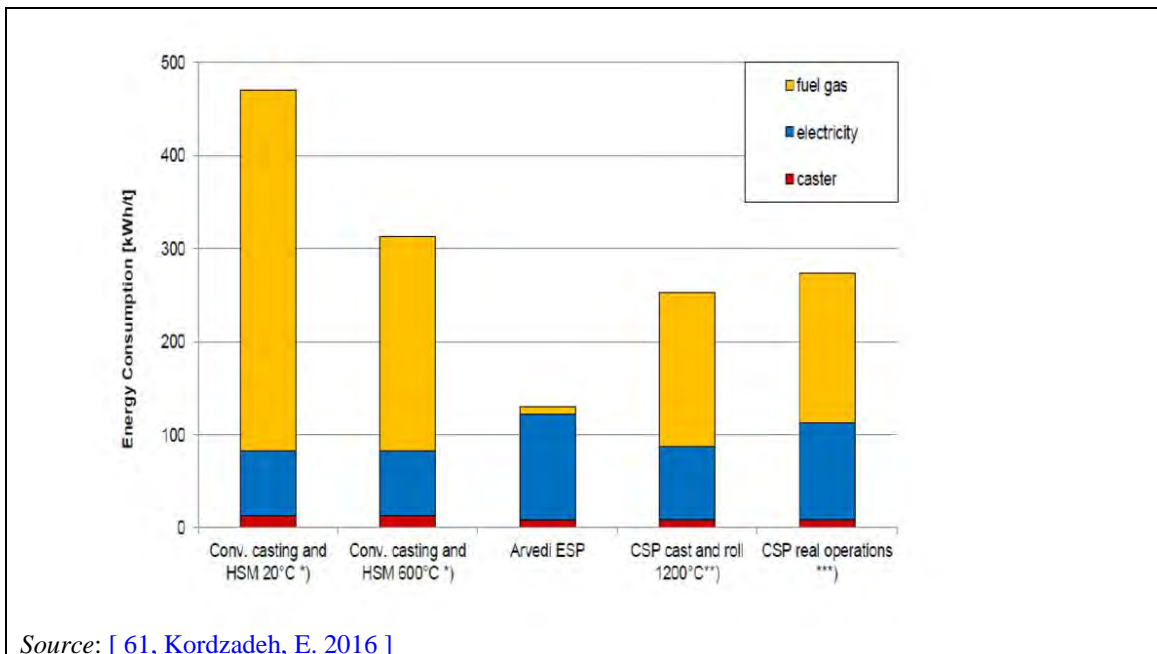
Grades cast by thin slab casting (commercial production):

- Plain carbon steels outside peritectic range (CSP).
- (0.065–0.15 %C) (CSP).
- High alloyed and stainless (CSP).
- Unalloyed structural steels (ISP).
- Alloyed structural steels (ISP).
- Line pipe steels (HSLA) (ISP).
- Oil field pipe steels (ISP).
- High alloyed austenitic and ferritic steels (ISP)
- Stainless steels CONROLL. [58, Brimacombe et al. 1996]
- Low- and ultra-low-carbon steel (CSP). [59, Albedyhl et al. 1998], [60, www.algoma.com 1998]
- C-steel grades with > 0.22 %.
- High strength (micro- and unalloyed) structural steel.
- Deep steel drawing grades.
- Microalloyed Nb steels.
- Cu alloyed structural steels. [58, Brimacombe et al. 1996]

Near-net-shape casting is employed for the production of :

- Low-carbon steel, higher strength unalloyed and micro-alloyed structural steel and C-steel > 0.22 %; [59, Albedyhl et al. 1998]
- High-quality stainless steel (austenitic grades, ferritic grades as well as martensitic grades (BHM, 142Jg. 1997, Heft 5, 210 – 214). [28, AT, TWG member 1999]

Figure 2.96 provides examples of energy consumption of conventional hot strip mills and plants using the CSP or ESP production process.



Source: [61, Kordzadeh, E. 2016]

Figure 2.96: Energy consumption for conventional hot strip mills (HSM) compared to ESP and CSP production processes.

Cross-media effects

No negative effects on other media are known.

Technical considerations relevant to applicability

Only applicable to plants adjacent to continuous casting and within the limitations of plant layout and product specifications.

For example, near-net-shape casting is not applicable for heavy plates. In the case of strips, it is not applicable for exposed parts such as automotive and packaging products. [62, EUROFER 2019]

Economics

The thin slab casting technique effectively opened the flat rolled market to mini mills. Implementation of this technology shrinks the size of the caster and shortens the length of the hot rolling mill, resulting in capital cost savings. Hot band, in the non-critical surface segment, can be economically produced with capacities up to 2 Mt/y with a one-strand caster, 3 Mt/year with a two-strand caster and up to 3.5 Mt/y with a three-strand caster.

Driving force for implementation

- Increased plant capacity.

Example plants

Plants from the adta collections: 110 HR1, 112 HR, 173 HR, 243 HR.

Table 2.24: Thin slab casting plants in the EU operating in 2020

Plant	Country	Technology	Slab thickness (mm)	Plant capacity (Mt/y)	Minimum thickness (mm)	Start date
ArcelorMittal, Sestao	ES	CSP	50	1.8	1.0	1996
Thyssenkrupp Steel Europe AG, Duisburg-Bruckhausen	DE	CSP	50	1.8	1.0	1999
Acciai Speciali, Terni (Stainless)	IT	CSP	60	1.0	1.5	2001
Arvedi	IT	ISP	60	1.2	1.0	1992
Tata Steel, IJmuiden	NL	ISP	70	1.3	0.8	2000
Arvedi	IT	ESP	70	2.3	0.8	2009

Source: [3, EUROFER 2020]

Reference literature

[3, EUROFER 2020], [14, Hot Rolling Shadow Group 2000], [16, FMP TWG 2018], [28, AT, TWG member 1999] [57, Worrell et al. 2010], [58, Brimacombe et al. 1996], [59, Albedyhl et al. 1998], [60, www.algoma.com 1998], [61, Kordzadeh, E. 2016], [62, EUROFER 2019], [63, Grobe et al. 1996].

2.4.2.18 Near-net-shape casting for beam blanks followed by rolling**Description**

Beam blanks are produced by combining casting and rolling into one process step. The need to reheat the feedstock before rolling and the number of rolling passes is reduced.

Technical description

Beam blank casting offers similar advantages for the production of beams as thin slab casting does for the production of flat products including lower rolling costs, higher productivity and reduced energy consumption.

Another – more common - form of ‘near-net-shape casting’ is applied in the field of long product rolling of structural steel. Instead of the traditional bloom with a rectangular or square cross section, the continuous caster produces an H, I or double T shaped beam blank.

Achieved environmental benefits

Reduced energy input in reheating and rolling.

Environmental performance and operational data

No information provided.

Cross-media effects

No negative effects on other media are known.

Technical considerations relevant to applicability

Only applicable to plants adjacent to continuous casting and within the limitations of plant layout and product specifications.

Economics

Beam blank casting provides several economic advantages including reduced rolling costs at the roughing mill with approximately 30 % lower investment costs, 15 % increased productivity, 1.5 % higher yield and 55 % reduced energy consumption at the roughing stand. [[64, Hoedl et al. 2003](#)]

Driving force for implementation

- Increased yield in the continuous caster due to the reduced material to be cropped.
- Increased specific heat transfer in the reheating furnace.
- Reduced time in the rolling process, increase in productivity. [[26, Hot Rolling Shadow Group 1999](#)]

Example plants

- Stahlwerke Thuringen (Germany). [[56, Hendricks et al. 1998](#)]
- ArcelorMittal Belval/Differdange (Luxembourg).
- ArcelorMittal Olaberria (Spain).
- Plants from the data collection: 91 HR, 99 HR2, 108 HR1, 108 HR2, 109 HR.

Reference literature

[[16, FMP TWG 2018](#)], [[26, Hot Rolling Shadow Group 1999](#)], [[56, Hendricks et al. 1998](#)], [[64, Hoedl et al. 2003](#)], [[65, Klose et al. 1994](#)].

2.4.2.19 General techniques to increase energy efficiency of heating and heat recovery techniques from flue gases

For general techniques to consider in the determination of BAT, see the techniques that are described in Chapter 8 (Sections 8.5, 8.5.3 and 8.5.4).

2.4.3 Descaling

See also Section 2.4.7.8 for a technique to reduce emissions to air from descaling.

2.4.3.1 Water spray descaling triggered by sensors

Description

Sensors and automation are used to track the position of the feedstock and adjust the volume of descaling water passing through the water sprays.

Technical description

Automation of the respective train areas and peripheral sensors allows the exact determination of the entry into and the delivery of the feedstock from the descaling equipment and allows the operator to open the valves of the pressure-water pipes accordingly. As a result, the water volume can be continuously adjusted to the descaling requirements.

Achieved environmental benefits

- Reduced water consumption.
- Reduced energy consumption.

Environmental performance and operational data

No information provided.

Cross-media effects

No information provided.

Technical considerations relevant to applicability

Generally applicable.

Economics

No information provided.

Driving force for implementation

No information provided.

Example plants

Widely used.

Reference literature

[[16, FMP TWG 2018](#)]

2.4.3.2 Use of high-pressure storage equipment

Description

High-pressure storage vessels are used to keep the water pressure constantly at a high level while reducing the number of start-up of high-powered pumps, thereby reducing energy consumption.

Technical description

Appropriately sized high-pressure storage vessels are used to temporarily store the high-pressure water and to reduce the starting phase of the high-powered pumps. In addition, it is possible to keep the pressure at a constant level when several simultaneous descaling processes are performed. This method helps to keep the energy consumption within reasonable limits and, in the case of several descaling processes at the same time, helps to ensure optimum cleaning and high-quality products due to the constant system pressure.

Achieved environmental benefits

Reduced energy consumption.

Environmental performance and operational data

No information provided.

Cross-media effects

No information provided.

Technical considerations relevant to applicability

- Generally applicable in roughing, finishing and plate mills' descaling systems.
- Generally applicable in hot rolling mills for flat products.

Economics

No information provided.

Driving force for implementation

No information provided.

Example plants

Widely used.

Reference literature

[\[16, FMP TWG 2018 \]](#)

2.4.4 Edging

2.4.4.1 Sizing press

Description

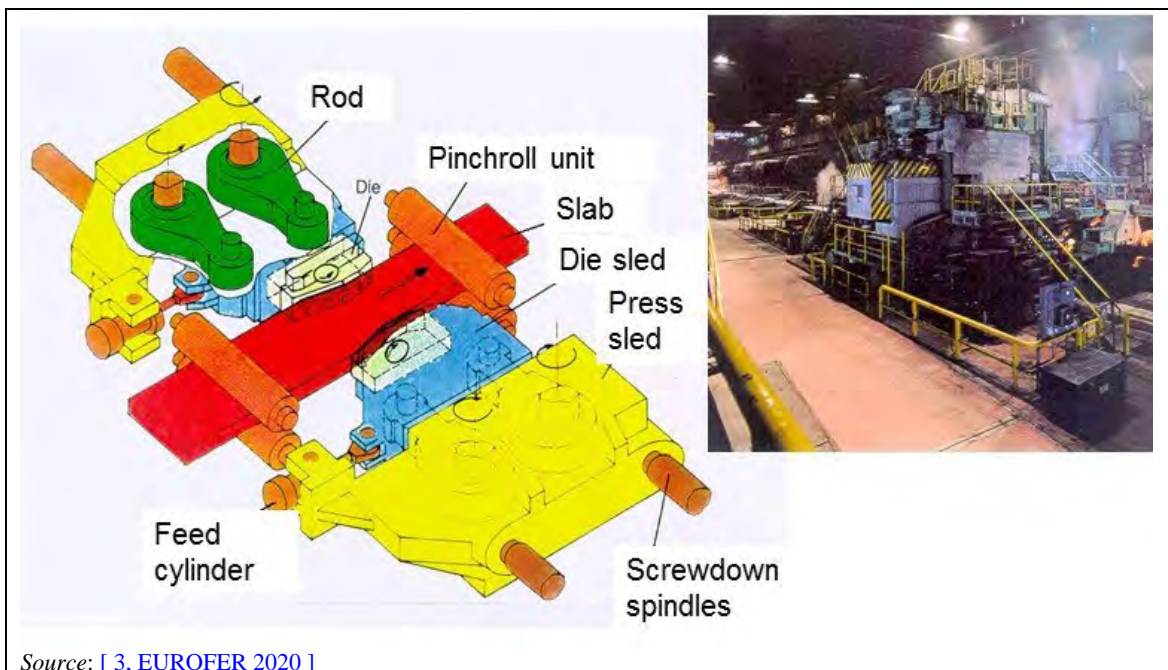
The use of a sizing press before the roughing mill enables the hot charging rate to be significantly increased and results in a more uniform width reduction both at the edges and centre of the product. The shape of the final slab is nearly rectangular, significantly reducing the number of rolling passes necessary to reach product specifications.

Technical description

In conventional vertical rolling, width reduction is limited to the slab edges with only little effect on the centre of the slabs. The material thickness increases at the edges, forming dog-bone-shaped cross sections. In horizontal rolling, a significant return in width (e.g. side spreading) takes place, resulting in low width reduction efficiency, increasing crop losses at head-end and tail-end, with significant width deviation along the slab.

With a sizing press, a pair of trapezoidal anvils compresses slabs in the width direction. In-line size presses, due to the forging effect on the slab, also increase the material thickness in the middle of the slab. The shape of the cross section is nearly rectangular and side spreading during horizontal rolling passes is reduced. A maximum width reduction of 350 mm is achievable in one pass through such equipment.

The use of a sizing press between the reheating furnaces and the roughing mill enables extensive width reduction which minimises crop losses and width deviation. It also allows a reduction in the number of different slab widths from continuous casting, increasing productivity and the hot charging rate. [\[3, EUROFER 2020 \]](#)



Source: [3, EUROFER 2020]

Figure 2.97: Schematic of the components and picture of a sizing press

In terms of pressing sequences, two different systems are employed: [3, EUROFER 2020]

- stop and go mode where the slab is stopped while being pressed;
- flying mode where the slab is moving with the anvil, while being pressed; in this case the material transfer speed is around 20 m/min.

Achieved environmental benefits

- Reduced energy consumption.
- Reduced trimming and cropping scrap.

Environmental performance and operational data

No information provided.

Cross-media effects

No information provided.

Technical considerations relevant to applicability

- Only applicable to hot strip mills.
- Only applicable to new plants and major plant upgrades.

Economics

No information provided.

Driving force for implementation

- Improved yield.
- Improved productivity for steelmaking and hot rolling.

Example plants

- ArcelorMittal Fos, Thyssenkrupp Steel Europe AG - Duisburg-Beeckerwerth, ArcelorMittal Taranto, Salzgitter Flachstahl.
- Plants from the data collections: 12 HR, 94 HR2, 106 HR, 108 HR1, 127 HR, 178 HR, 193 HR2, 193 HR3.

Reference literature

[3, EUROFER 2020], [4, EUROFER 1998], [16, FMP TWG 2018].

2.4.4.2 Automatic width control comprising short stroke control

Description

With an automatic width control and short stroke function system, the edging process is assisted and controlled by computer models, resulting in fewer defects of the final slab product with less width variations across the transfer bar and a more rectangular shape at the strip ends.

Technical description

In conventional edging the width of the slab is reduced independently of the actual width and temperature of the material, therefore generating width variations along the transfer bar, especially under high width reductions. With the aid of an automatic width control (AWC) system, the edging process is performed via computer models. For the strip ends (head and tail), the edging values are reduced across a defined length and thus the formation of so-called tongues at the strip head and/or fishtails occurring in conventional rolling are avoided (see Figure 2.98).

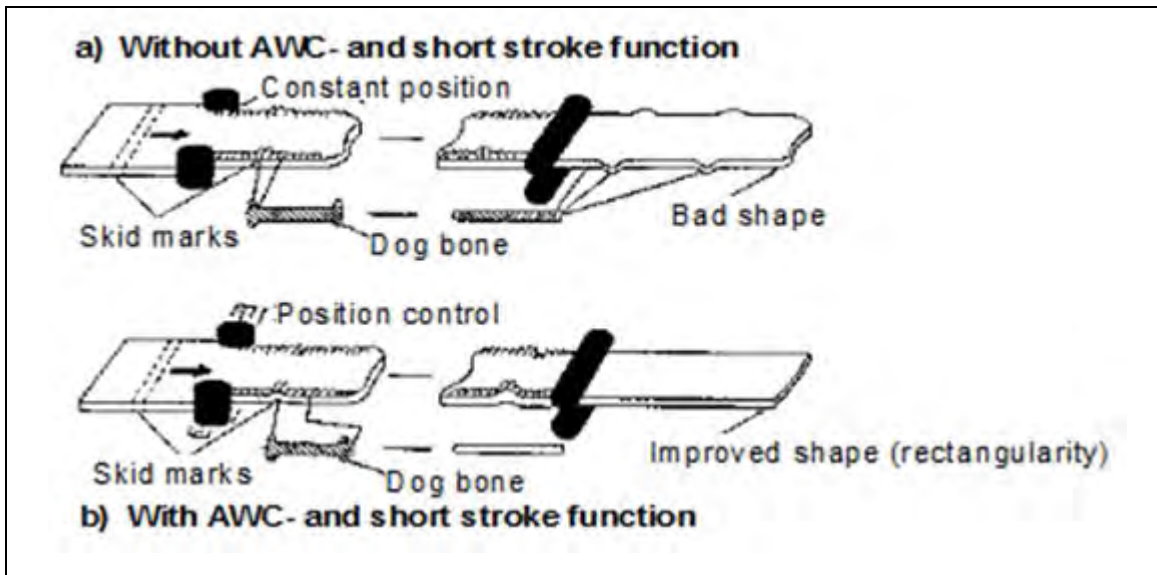


Figure 2.98: Automatic width control system operation

Achieved environmental benefits

Reduced trimming, head and tail scrap.

Environmental performance and operational data

No information provided.

Cross-media effects

Increased product quality, improved yield, therefore less material has to be recycled; energy consumption and emissions are reduced.

Technical considerations relevant to applicability

- Generally applicable in roughing, finishing and plate mills.
- Generally applicable in hot rolling mills for flat products.

Economics

No information provided.

Driving force for implementation

Improved yield.

Example plants

Plants from the data collections: 08-09 HR, 11 HR, 37 HR, 38 HR, 56 HR, 88 HR, 94 HR1, 94 HR2, 99 HR1, 103 HR3, 106 HR, 108 HR1, 109 HR, 110 HR1, 110 HR2, 112 HR, 118 HR, 121 HR, 126 HR, 127 HR, 157 HR2, 178 HR, 179 HR, 203 HR, 222 HR, 230 HR, 231 HR, 244 HR, 265 HR, 273 HR.

Reference literature

[16, FMP TWG 2018].

2.4.5 Roughing

See also Section 2.4.7.8 for a technique to reduce emissions to air from roughing.

2.4.5.1 Computer-aided rolling optimisation**Description**

The thickness reduction is controlled using a computer to minimise the number of rolling passes.

Technical description

The use of computers allows the adjustment of the thickness reduction per pass. In other words, slabs and blooms are reduced to a rough strip by applying the lowest possible number of passes, even in the case of short interruptions resulting in temperature losses of the material.

Achieved environmental benefits

- Reduced energy consumption.
- Furnace discharge temperature can be decreased.
- Number of roll passes is optimised.
- Reduction of rolling cobbles, resulting in an improvement of the overall yield. [3, EUROFER 2020]

Environmental performance and operational data

No information provided.

Cross-media effects

No information provided.

Technical considerations relevant to applicability

Generally, there are no technical restrictions to the applicability of this technique.

Economics

No information provided.

Driving force for implementation

No information provided.

Example plants

Widely used.

Reference literature

[3, EUROFER 2020], [16, FMP TWG 2018].

2.4.6 Transport of rolled stock from roughing mill to finishing train

2.4.6.1 Coil boxes

Description

Insulated boxes are installed between the roughing mill and the finishing mill to minimise temperature losses from feedstock during coiling/uncoiling processes and allow for lower rolling forces in hot strip mills.

Technical description

The intermediate product produced in the roughing train (transfer bar) is wound up to a coil without a mandrel by means of appropriately arranged, electrically driven pinch/bending rolls and cradle rolls. After completion of coiling, the coil is placed on an uncoiling device, decoiled, and passed to the finishing stand (see Figure 2.99). During the uncoiling process and finishing rolling, the coiler is free to receive the next rough strip. In this way, bottlenecks in the production flow can be avoided.

This equipment has the advantage that the temperature distribution across the length of the transfer bar remains constant and the loads during finishing rolling are reduced. On the other hand, the additional energy requirement for the coiling operations must be considered. When modernising existing mills, the product range may be increased.

In the event of a cobble downstream, the coiled bar may be held for a longer period than would otherwise be possible. For longer mill breakdowns, the coiled transfer bar might be stored in so-called heat recovery furnaces. Both measures thereby improve the yield. However, coil boxes may result in increased surface defects.

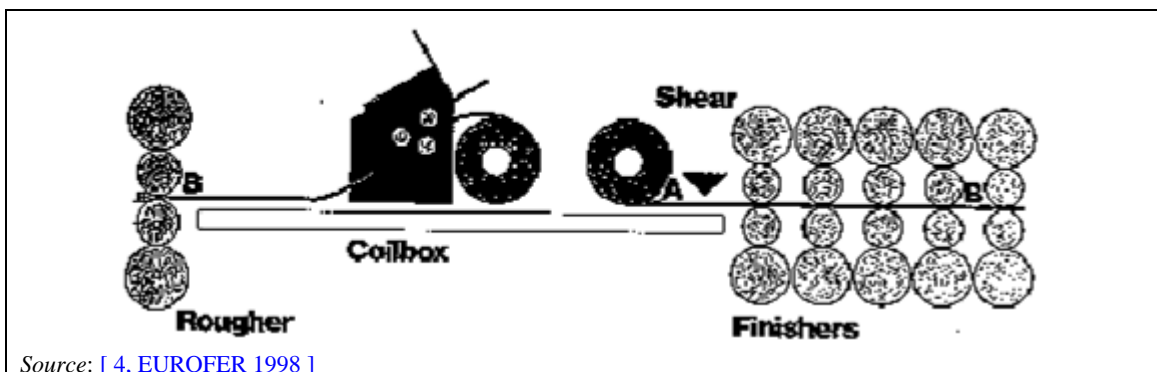


Figure 2.99: Coil box arrangement

Achieved environmental benefits

- Reduced energy consumption.
- Less rolling force required (temperature in stock is higher and more uniform).

Environmental performance and operational data

In some cases, a coil box can limit the maximum mill production. [26, Hot Rolling Shadow Group 1999]

Cross-media effects

No information provided.

Technical considerations relevant to applicability

Generally, there are no technical restrictions to the applicability of this technique.

Economics

No information provided.

Driving force for implementation

Improved yield.

Example plants

Plants from the data collections: 66 HR, 118 HR, 157 HR2, 179 HR, 230 HR, 244 HR, 265 HR.

Reference literature

[[16, FMP TWG 2018](#)], [[26, Hot Rolling Shadow Group 1999](#)].

2.4.6.2 Coil recovery furnaces**Description**

Coil recovery furnaces are used as an addition to coil boxes to restore the rolling temperature of coils and return them to a normal rolling sequence in the event of rolling mill interruptions.

Technical description

Coil recovery furnaces were developed as an addition to coil box installations, so that in case of longer rolling interruptions the coils could be restored to rolling temperature and returned to the rolling sequence, which results in a yield improvement. Temperature losses are minimised and even rolling breaks of up to 2 hours can be covered.

Heating and cooling temperature models determine the correct heating cycle for each coil, taking into account the temperature profile of the coil at the start of heating. This profile is determined from data from the mill computer on the temperature at the roughing pass, the time elapsed before and after coiling, as well as bar size and grade. Coils saved using the recovery furnace are rolled into prime hot band, providing they are rolled within 2 hours. Coils held for longer periods are processed to 'non-surface critical' products. (The furnace can be built with an inert gas system.)

Achieved environmental benefits

Reduced energy consumption.

Environmental performance and operational data

No information provided.

Cross-media effects

No information provided.

Technical considerations relevant to applicability

- Generally applicable in combination with coil boxes at roughing stands.
- Generally applicable in hot rolling mills for flat products.

Economics

No information provided.

Driving force for implementation

Improved yield.

Example plants

Plants from the data collection: 158 HR, 179 HR.

Reference literature

[[16, FMP TWG 2018](#)].

2.4.6.3 Strip edge heating

Description

Transfer roller tables in hot strip mills are equipped with natural gas burners or inductive heating devices to heat the surface edges of slabs and to maintain uniform slab temperatures.

Technical description

In order to raise the temperature of the cooler strip edges to the overall temperature level and achieve a constant temperature profile across the strip width, the transfer roller table is equipped with additional gas or inductive heating devices.

Achieved environmental benefits

- Reduced energy consumption in finishing rolling.
- Reduced wear occurring on the work rolls (less grinding sludge).

Environmental performance and operational data

No information provided.

Cross-media effects

Energy used for edge heating.

Technical considerations relevant to applicability

- Generally applicable in transport roller table between roughing and finishing mills.
- Generally applicable in hot rolling mills for flat products.

Economics

No information provided.

Driving force for implementation

Improved yield.

Example plants

Plant from the data collection: 126 HR.

Reference literature

[\[16. FMP TWG 2018 \]](#).

2.4.7 Rolling

2.4.7.1 Crop optimisation

Description

The cropping of the feedstock after roughing is controlled by a shape measurement system (e.g. camera) in order to minimise the amount of metal cut off.

Technical description

By the use of charged-coupled device cameras, combined with a width measurement subsequent to the roughing train, the real crop shape of the ingoing rough strip is identified. An automatic system ensures that the cutting action of the shears is limited to cutting off materials outside the rectangular area of the transfer bar (See Figure 2.100).

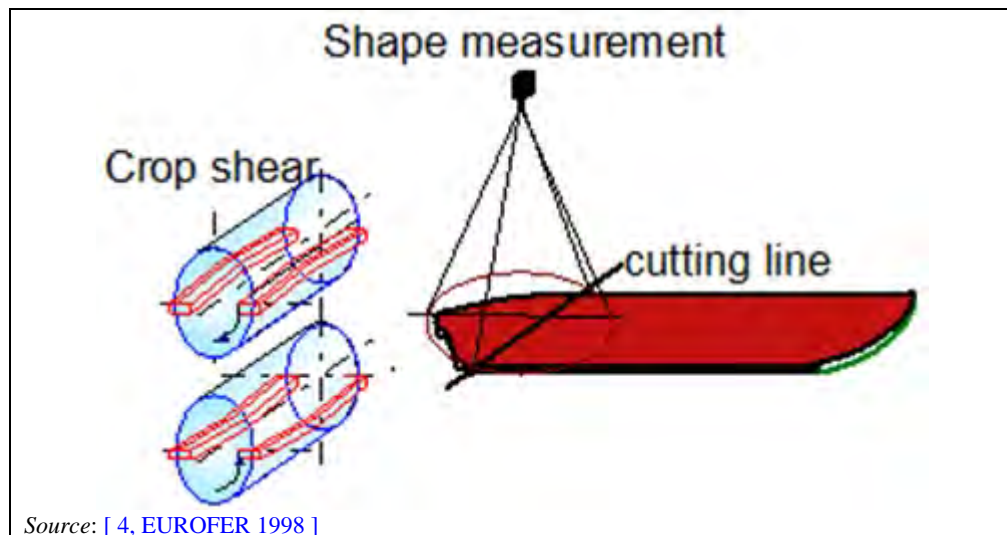


Figure 2.100: Crop optimisation system

Achieved environmental benefits

Scrap (head and tail) reduction.

Environmental performance and operational data

No information provided.

Cross-media effects

No information provided.

Technical considerations relevant to applicability

- Generally applicable at the entry of finishing trains.
- Generally applicable in hot rolling mills for flat products.

Economics

No information provided.

Driving force for implementation

Improved yield.

Example plants

Widely used.

Reference literature

[16, FMP TWG 2018].

2.4.7.2 Reduction of the rolling friction

Description

Rolling oils are carefully selected. Pure oil and/or emulsion systems are used to reduce the friction between the working rolls and the feedstock and to ensure minimal oil consumption. In HR, this is usually carried out in the first stands of the finishing mill. [3, EUROFER 2020]

Technical description

Rolling oils are supplied to the roll gap via nozzles in order to reduce the friction between material and roll, to lower the drive power requirements, to decrease rolling forces and to improve the surface quality of rolled material.

Achieved environmental benefits

- Reduced energy consumption by reduced rolling load.
- Reduced roll wear (especially at the strip edge areas), resulting in a longer lifetime of work rolls and reduction of grinding sludge.

Environmental performance and operational data

No information provided.

Cross-media effects

Contamination of water system with rolling oils.

Technical considerations relevant to applicability

Only applicable to hot strip mills.

Economics

No information provided.

Driving force for implementation

Higher mill productivity.

Example plants

Widely used.

Reference literature

[3, EUROFER 2020], [16, FMP TWG 2018].

2.4.7.3 Forced interstand strip cooling

Description

Forced interstand strip cooling helps to maintain the required exit rolling temperature over the whole strip length using water sprays or water curtains and enables rolling at a higher speed, increasing the mill production.

Technical description

Forced interstand cooling of the strip by water sprays or water curtains is employed to permit acceleration of the finishing train while still attaining a constant finishing temperature.

Achieved environmental benefits

- The formation of scale and oxide fumes is suppressed.
- Decreased wear rate of the work rolls in successive stands and reduced grinding sludge.

Environmental performance and operational data

No information provided.

Cross-media effects

Generation of waste water.

Technical considerations relevant to applicability

- Generally applicable between finishing stands.
- Generally applicable in hot rolling mills for flat products.

Economics

No information provided.

Driving force for implementation

No information provided.

Example plants

Plants from the data collection: 08-09 HR, 37 HR, 94 HR1, 97 HR, 106 HR, 108 HR1, 110 HR1, 110 HR2, 121 HR, 157 HR2, 178 HR, 179 HR, 193 HR3, 222 HR, 241 HR1, 244 HR, 246 HR2, 249 HR, 265 HR, 273 HR, 300 HR.

Reference literature

[[16, FMP TWG 2018](#)].

2.4.7.4 Interstand strip tension control**Description**

Looper systems combined with computer models are used to accurately calculate the strip tension between finishing stands in order to prevent necking of the strip after threading and to reduce excessive trimming of strips.

Technical description

Normally loopers are used for controlling strip tension between finishing stands. Various looper designs (hydraulic, low inertia and tension measuring devices) are available. Additionally, so-called looper-less techniques have been developed but their successful operation depends largely on the measurement accuracy of processing parameters. Improved looper systems combined with computer models for calculating the strip tension and appropriate electronics control facilitates the independent control of both tension and looper height. This mainly avoids necking of the strip after threading and unstable operation.

Automatic systems for controlling the strip width when leaving the finishing mill train and/or approaching the coilers (with feedback to the computer models of the finishing train) supports the tension control system.

Achieved environmental benefits

Trimming scrap is reduced by avoiding ‘necking’ during threading and unstable operation.

Environmental performance and operational data

No information provided.

Cross-media effects

No information provided.

Technical considerations relevant to applicability

- Generally applicable in finishing trains.
- Generally applicable in hot rolling mills for flat products (part of mill automation systems).

Economics

No information provided.

Driving force for implementation

Improved yield.

Example plants

Widely used.

Reference literature

[[16, FMP TWG 2018](#)].

2.4.7.5 Strip profile and flatness control

Description

In hot strip mills and heavy plate mills, the cross-sectional profile and flatness of the hot band is controlled using advanced computer models in order to achieve the desired strip profile without exceeding the required flatness tolerances.

Technical description

The cross-sectional profile and flatness of the hot band is of importance for subsequent processing and is dependent on a number of operating conditions including the pass schedule practice.

The principle purpose of strip profile and flatness control in rolling mills is to achieve the desired strip profile without exceeding the required flatness tolerances. In application to hot rolling mills, strip profile and flatness control systems are commonly designed to achieve the following targets:

- strip crown control range from approximately 0 μm to 75 μm ;
- strip crown tolerances;
- strip flatness of approximately 10 I-Units (I-Unit: $\Delta L/L = 10^{-5}$ m);
- reduction in edge drop.

To maintain good strip flatness in hot strip mills, there are only certain maximum changes in the strip crown to thickness ratio that are possible in one rolling pass without introducing undesirable disturbances to strip flatness, known as 'flatness deadband'. Different actuators are developed for an objective selection of strip profile and flatness:

- work roll and back-up roll bending systems;
- flexible body adjustable crown rolls;
- flexible edge adjustable crown rolls;
- roll crossing systems;
- axially shifting systems with non-cylindrical rolls;
- axially shifted cylindrical rolls;
- automatic gauge control;
- automatic flatness control.

In hot strip mills, each stand is usually equipped with a roll bending system that can be either crown in, crown out or both. If that is not sufficient to reach the crown requirements, the stands can be equipped with additional actuators such as CVC rolls (Continuously Variable Crown), UPS rolls, roll crossing systems or others. A computer mill set-up model, sometimes comprising neural networks, calculates the required settings of profile and flatness actuators under consideration of the thermal crown of the roll body to obtain the desired strip crown and flatness.

Downstream of the mill stands, profile measuring devices (sensors) are installed to monitor the actual crown. The actual crown is compared to the target and the difference is used to produce changes mainly in the roll bending forces. Flatness control loops lead to nearly constant strip crown-to-thickness ratio. Shape meter devices are installed either at the end of the finishing train or between mill stands to monitor the actual flatness. Detected flatness errors are again used to adjust roll bending forces.

Achieved environmental benefits

- Reduced scrap.
- Improvement of rolling conditions for cold rolled products. [[3, EUROFER 2020](#)]

Environmental performance and operational data

No information provided.

Cross-media effects

No information provided.

Technical considerations relevant to applicability

- Generally applicable in finishing and heavy plate mills.
- Generally applicable in hot rolling mills for flat products (part of automatic process control).

Economics

No information provided.

Driving force for implementation

No information provided.

Example plants

Widely used.

Reference literature

[\[16, FMP TWG 2018 \]](#).

2.4.7.6 Work roll cooling**Description**

Different water spray nozzle types and spray header configurations are used to cool the work rolls, prevent damage and cracks in the rolls and reduce the formation of scale.

Technical description

In the mill stands a wide variety of water spray nozzle types and spray header configurations are used to cool the work rolls. This is important to avoid damage and cracks in the rolls (which means less grinding operations and waste generation) and reduces the formation of scale.

Achieved environmental benefits

- Reduced scale formation.
- Reduced roll wear and reduced grinding sludge.

Environmental performance and operational data

No information provided.

Cross-media effects

No information provided.

Technical considerations relevant to applicability

- Generally applicable in roughing, finishing and plate mills.
- Generally applicable in hot rolling mills for flat products.

Economics

No information provided.

Driving force for implementation

No information provided.

Example plants

Widely used.

Reference literature

[3, EUROFER 2020], [16, FMP TWG 2018].

2.4.7.7 Finishing train automation – process and basic automation

Description

Process computers supported by control loops are used for production planning and control of furnaces in rolling mills, allowing real-time updates of the production schedule in case of interruptions.

Technical description

High-quality materials can be produced by using process computers supported by appropriate control loops (basic automation - level I) for production planning and control of furnaces and roughing mills. In the event of short rolling interruptions, the implemented flexible software models allow pass schedule changes up to the last moment (just before grabbing in the first stand).

Achieved environmental benefits

Reduced scrap from short mill breakdowns.

Environmental performance and operational data

No information provided.

Cross-media effects

No information provided.

Technical considerations relevant to applicability

- Generally applicable in finishing mills.
- Generally applicable in hot rolling mills for flat products.

Economics

No information provided.

Driving force for implementation

Increased yield.

Example plants

Widely used.

Reference literature

[16, FMP TWG 2018].

2.4.7.8 Air extraction as close as possible to the emission source for mechanical processes and welding combined with waste gas treatment

Description

Emissions from slitting, descaling, roughing, rolling, finishing, levelling and welding are collected, for example using hood or lip extraction. Abatement systems employed to treat dust emissions include fabric filters, ESPs and wet scrubbers. For roughing and rolling, in the case of low levels of dust generation, e.g. below 100 g/h, water sprays can be used instead (see Section 2.4.7.9).

Technical description

Dust particles (e.g. iron oxide) are released in the hot rolling processes as fugitive emissions. Depending on the steel category processed, these particles may contain heavy metals such as nickel and lead. In rolling, the airborne particles are released mainly at the exit side of mill stands (where the speed of the mill stands is the highest). Generally, for cooling purposes and in order to suppress fugitive dust emissions, water sprays are used, but mainly in the case of low levels of dust generation (See Section 2.4.7.9). The efficiency of water sprays is low and, where emissions are significant, dedicated exhaust systems are used including: suction hoods, dust hoods, lip extraction or suction lines. Emissions are treated using different types of abatement systems including water sprays, venturi scrubbers, wet electric filtering or other exhaust systems such as pulse-jet filters (dry-type, bag filters) or wet filters.

Venturi scrubbers

In roughing mills, the rolling dust is extracted with a high-pressure scrubber (30 bar) and conducted to venturi scrubbers. The collected sludge is led on to the scale canal and to the hot rolling mill water circuit. Scale is collected from the water circuit and can be further processed as raw material in the melt shop. [\[25, EUROFER 2018 \]](#)

Wet electric filters

Dust from hot rolling mills is cleaned using a two-step wet electric filter. The first step consists of treating the dust-bearing gas to be purified using water sprays to saturate it with water vapour before entering a second step in an electrical field where it is precipitated. Collected dust sludge can be further processed to be used as a raw material in the melt shop. [\[25, EUROFER 2018 \]](#)

Pulse-jet filters (dry or fabric filter) / Wet filters

Another option is to install an exhaust system, where dust hoods are installed between the mill stands (mainly behind the last three finishing stands) to collect the dust and oxides. Via suction pipes at the mill drive side, the oxide-dust mixture is drawn off and routed to pulse-jet filters (dry-type, fabric filter) or wet filters. The separated dust and oxides are transported into buckets via screw conveyors and are recycled in integrated steel plants.

Achieved environmental benefits

- Reduction of dust emissions.
- Reduction of emissions of metals, including heavy metals (e.g. nickel and lead).

Environmental performance and operational data

Dust emission levels of less than 5 mg/Nm³ can be achieved with venturi scrubbers, ESPs or fabric filters. Venturi scrubbers typically have separation efficiencies of 90–95 %. Wet electric filters typically have separation efficiencies of 99 %. [\[16, FMP TWG 2018 \]](#), [\[25, EUROFER 2018 \]](#)

Cross-media effects

- Dry systems consume energy but, like exhaust/bag filters, have the advantage that they avoid the need to recover the oxides from waste water and the collected dust can be recycled internally. [\[14, Hot Rolling Shadow Group 2000 \]](#)
- Consumption of water and electricity.

Technical considerations relevant to applicability

- May not be applicable for welding in the case of low levels of dust generation, e.g. below 50 g/h.
- In the case of welding, the data collection showed that two plants reported very different dust mass flows (i.e. Plant 08-09 HR3: 1.8 g/h and 37-HR2: 184 g/h). Generally, dust emissions from welding in HR are relatively low (in terms of concentrations and mass flows) but, in some cases, more significant emissions may occur. Therefore, it was considered appropriate to include a mass flow threshold of 50 g/h above which extraction and abatement is used to control dust emissions.
- Fabric filters may not be applicable in the case of waste gases with a high moisture content.

Economics

No information provided.

Driving force for implementation

- Reduction of dust emissions.
- Reduction of emissions of ferrous oxides. [[27, Van Roosbroeck 1999](#)]

Example plants

Widely used.

Reference literature

[[14, Hot Rolling Shadow Group 2000](#)], [[16, FMP TWG 2018](#)], [[25, EUROFER 2018](#)], [[27, Van Roosbroeck 1999](#)].

2.4.7.9 Use of water sprays in the case of low levels of dust generation

Description

Water spraying injection systems are installed at the exit side of each roughing and rolling stand to abate dust generation. The humidification of dust particles facilitates agglomeration and dust settling. The water is collected at the bottom of the stand and treated (see Section 8.9).

Technical description

The particles suppressed by the water sprays are led to the roller table flumes and on to the water treatment, where they are recovered in settling basins and filters. Water sprays can only be used in the case of low levels of dust generation, e.g. below 100 g/h.

Achieved environmental benefits

Reduction of dust emissions.

Environmental performance and operational data

Water sprays are installed in the last finishing stand. For instance, the equipment may comprise 6 nozzles in the upper part and 8 nozzles in the lower part at each stand. The water is sprayed at a flow-rate of 22 l/min and a pressure of 8 bars. The total water flow of the spraying system is 35 m³/h.

Table 2.25: Typical reduction of fugitive emissions by water spraying

Sampling location Sampling Duration: 3 h	Concentration of particulate matter	
	without spraying	with spraying
Above the finishing mill	6.02 mg/Nm ³	2.35 mg/Nm ³
Roof	2.77 mg/Nm ³	0.63 mg/Nm ³

Source: [[27, Van Roosbroeck 1999](#)]

The measuring system does not correspond to any standard, because the emissions are more or less diffuse. The sampling points were chosen after evaluating from where the emissions came due to aspiration in the workshop because there were no well-defined flows.

Cross-media effects

- Water sprays result in waste water; oxides have to be recovered from the waste water.
- Consumption of water and electricity.

Technical considerations relevant to applicability

Water sprays are only applicable in the case of low levels of dust generation, e.g. below 100 g/h.

Economics

No information provided.

Driving force for implementation

Reduction of dust emissions.

Example plants

In total, more than 23 HR plants reported the use of water sprays (e.g. 55 HR, 56 HR, 158 HR3, 238 HR, 246 HR2, 247 HR4).

Reference literature

[[16, FMP TWG 2018](#)], [[27, Van Roosbroeck 1999](#)].

2.4.7.10 Hydraulic coilers comprising step control**Description**

Hydraulically operated coilers with step control systems lift the wrapper rollers automatically using sensors when the strip head passes the individual roller in order to reduce the amount of crop scrap and increase the production yield.

Technical description

In conventional coiling, the strip is in contact with the wrapper rollers during at least three turns of the mandrel and penetrates the overlaying winding. These parts of the hot band have to be removed for subsequent processing in the cold rolling mill. Hydraulically operated coilers comprising step control systems lift the wrapper rollers automatically, commanded by sensors, when the strip head passes the individual roller.

Achieved environmental benefits

- The amount of crop scrap in the subsequent processes is reduced.
- Reduction of cobbles at coilers level. [[3, EUROFER 2020](#)]

Environmental performance and operational data

No information provided.

Cross-media effects

No information provided.

Technical considerations relevant to applicability

Only applicable to hot strip mills.

Economics

No information provided.

Driving force for implementation

Increased yield.

Example plants

Plants from the data collection: 08-09 HR, 12 HR, 94 HR1, 97 HR, 106 HR, 110 HR1, 110 HR2, 112 HR, 121 HR, 126 HR, 127 HR, 157 HR2, 158 HR, 179 HR, 222 HR, 244 HR.

Reference literature

[[16, FMP TWG 2018](#)].

2.4.7.11 Control of the feedstock shape during rolling

Description

Any deformations of the feedstock during rolling are monitored and controlled in order to ensure that the rolled steel has a shape as rectangular as possible and to minimise the need for trimming.

Technical description

During conventional plate rolling by maintaining a constant plate thickness during each rolling pass, a distinct distortion of the plate plan view from true rectangular shape takes place. Employing shape-controlled rolling, tapered thickness profiles or dog bones will be produced during rolling. Supported by measurements (load or shape), the amount of dog bone formation or tapering is computed and the correction signals are sent to the roll-adjusting system. The plan view control is mainly employed as an addition to the automatic gauge system. The term 'shape rolling or plan view control' is applied to a range of techniques that employ rolling a plate of variable thickness during the intermediate passes, which results in rectangular final plate shape and a reduction in trimming scrap.

Achieved environmental benefits

Reduced scrap.

Environmental performance and operational data

No information provided.

Cross-media effects

No information provided.

Technical considerations relevant to applicability

- Generally applicable in heavy plate mills.
- Generally applicable in new plants and with limitations for existing plants.

Economics

No information provided.

Driving force for implementation

Increased yield.

Example plants

Plants from the data collection: 08-09 HR, 56 HR, 94 HR2, 157 HR1, 172 HR, 243 HR, 298 HR, 175 HR.

Reference literature

[\[16, FMP TWG 2018 \]](#).

2.4.7.12 On-line heat treatment (accelerated cooling)

Description

On-line heat treatment with accelerated cooling enables the production of steel rolled products with the required material structure and mechanical properties without the need for additional reheating steps to reach specifications.

Technical description

On-line heat treatment of rolled materials with accelerated cooling is used at hot rolling plants to reach the required material structure and mechanical properties without the need for reheating. Heat treatment provides an efficient way to manipulate the properties of steel provided that the cooling rate of the steel product is controlled accurately. The rate of cooling is

defined by a heat transfer coefficient. Good controllability of the heat transfer coefficient can be reached using either air-water or water nozzles. Thus, an on-line heat treatment with the assistance of spray nozzles enables a manufacturing process that can improve product performance by increasing steel strength, hardness and other desirable characteristics, while reducing the overall energy consumption of the hot rolling mill. [66, Hnizdil et al. 2018], [67, Kotrbacek et al. 2006]

Achieved environmental benefits

Reduced energy consumption and emissions from subsequent heat treatment furnaces.

Environmental performance and operational data

No information provided.

Cross-media effects

No information provided.

Technical considerations relevant to applicability

- Mainly applicable to heavy plate mills.
- Generally applicable in new plants and with limitations for existing plants.

Economics

No information provided.

Driving force for implementation

No information provided.

Example plants

Widely used.

Reference literature

[16, FMP TWG 2018], [66, Hnizdil et al. 2018], [67, Kotrbacek et al. 2006].

2.4.7.13 Thermomechanical rolling operation

Description

Thermomechanical rolling allows the production of steel slabs with very high strength and toughness without the need for additional heat treatments, resulting in an overall reduction of energy consumption in the rolling mill.

Technical description

In a ‘thermomechanical rolling operation’, the properties of hot rolled plates or sections are influenced to reduce the need for subsequent heat treatment. Slabs or blooms/beam blanks from the reheating furnace are rolled to an intermediate thickness, followed by a holding period (during which water sprays may be applied) to cool down to a desired temperature and are then finally rolled. Thermomechanical rolling leads to the slab achieving a finer-grained microstructure. This technique provides very high strength and very good toughness to the slab product using less alloying additives and with or without a reduced need for subsequent heat treatments, such as normalising. In addition, thermomechanically rolled steels exhibit much better weldability than normalised steel.

Achieved environmental benefits

- Reduced energy consumption.
- Reduction of emissions from heat treatment.

Environmental performance and operational data

No information provided.

Cross-media effects

No information provided.

Technical considerations relevant to applicability

- Mainly applicable to plate and section mills.
- Generally applicable, provided sufficient rolling power is available. [[26, Hot Rolling Shadow Group 1999](#)]

Economics

No information provided.

Driving force for implementation

No information provided.

Example plants

Plants from the data collection: 08-09 HR, 16 HR, 56 HR, 91 HR, 94 HR2, 99 HR2, 106 HR, 108 HR1, 109 HR, 110 HR1, 110 HR2, 121 HR, 127 HR, 152 HR, 157 HR1, 157 HR2, 172 HR, 196 HR, 222 HR, 241 HR1, 243 HR, 244 HR, 288 HR.

Reference literature

[[16, FMP TWG 2018](#)], [[26, Hot Rolling Shadow Group 1999](#)].

2.4.7.14 Three-roll stand

Description

A three-roll stand increases the section reduction per pass, resulting in an overall reduction of the number of rolling passes required for producing wire rods and bars.

Technical description

A three-roll stand is a finishing rolling mill suitable for use in wire rod and bar mills. It is composed of a rolling stand containing three rolls and associated guides with adjustable positions which enable the rolling of products to very tight size tolerance and any desired finished size within a specified size range. Compared to conventional intermediate mills, the three-roll technique increases the production flexibility and productivity of the plant while reducing energy and lubricant consumption.

In conventional rolling mills, the tolerance of the finished product is influenced mainly by the variations in the cross section of the feed material entering the finishing section of the mill. A three-roll stand for the production of wire rods and bars allows twist-free rolling of quality steels, special grades, super alloys, sintered materials as well as non-ferrous metals and their alloys in very compact blocks. In addition, a three-roll stand reduces the spread during deformation. As a result, deformation homogeneity during rolling is improved.

A three-roll stand is equipped with a quick stand changing system and advanced roll changing and adjustment facility in the roll shop, enabling extremely quick stand and roll changes. It also provides the possibility to jump to and from any size in the mentioned range of finished bar sizes (sequence-free rolling). As a result, the production flexibility of the plant is significantly improved and productivity is increased with high gains in yield and throughput. Finally, a three-roll stand allows rolling at temperatures lower than in conventional finishing mills, resulting in significant energy savings. [[68, Ammerling et al. 2005](#)]

Figure 2.101 provides a schematic of a three-roll stand.

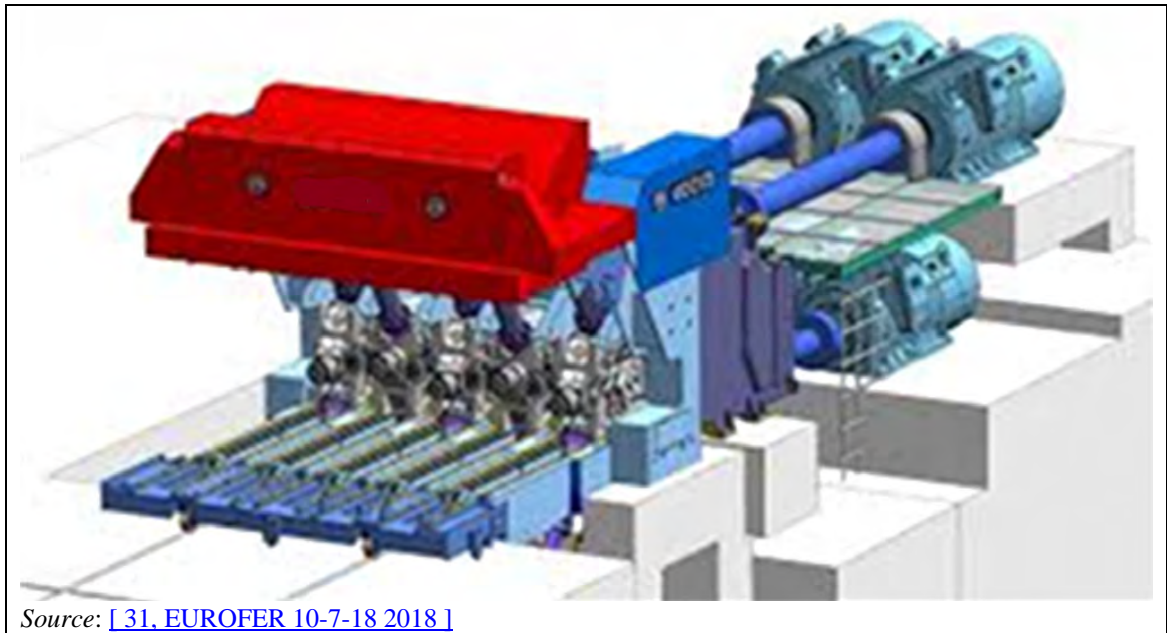


Figure 2.101:Schematic of a three-roll stand

Several versions of the three-roll stand technologies are commercially available including the following:

- Three-roll reducing and sizing block
Finishing block for bar and/or pre-finishing block for wire rod within a diameter range of 5.0–160.0 mm as well as corresponding hexagon dimensions.
- Three-roll pre-finishing block
For sizing of entry cross section for the wire rod finishing block within a diameter range of 5.0–30.0 mm as well as corresponding hexagon dimensions.
- Three-roll reducing block
In roughing and intermediate mills of wire rod and bar mills to produce intermediate sizes within a diameter range of 12.0–160.0 mm as well as corresponding hexagon dimensions.
- Three-roll wire rod finishing block
Finishing block in wire rod mills for finishing sizes within a diameter range of 5.0–23.0 mm as well as corresponding hexagon dimensions.

Achieved environmental benefits

- Reduced oil consumption due to lower rolling temperatures and quick stand changes.
- Reduced energy consumption due to reduced temperatures during rolling.

Environmental performance and operational data

It has been reported that the installation of a three-roll stand at a conventional bar mill has resulted in a productivity increase of 14.9 % (the productivity being expressed in tonnes/operating hours). Similarly, in conventional wire rod and bar mills, productivity increases between 14.4 % and 16.1 % are reported. Installation of a three-roll stand also significantly reduces the oil consumption (e.g. approximately 20 % and 80 % decrease in the consumption of lubricating and hydraulic oils, respectively, in comparison with conventional wire rod and bar mills). [31, EUROFER 10-7-18 2018]

Cross-media effects

None.

Technical considerations relevant to applicability

Generally, there are no technical restrictions to the applicability of this technique.

Economics

- Economic benefits due to reduced downtime for size and grade changes (quick stand and roll changing).
- Economic benefits due to increased rolling speed and throughput.
- The installation of a three-roll stand in a conventional mill increases the rolling speed and productivity by approximately 20 % which provides a quick return on the relatively high initial investment costs. [[69, Seki et al. 2007](#)]

Driving force for implementation

- Reduced costs due to minimised downtime and increased productivity by transferring all operations that interrupt production from the mill line to the roll shop. [[68, Ammerling et al. 2005](#)]
- Increased flexibility within the intermediate mill with the possibility of rolling different finished sizes at any time.
- The utilisation of a three-roll stand results in very uniform deformation, with less spreading and more elongation during the rolling process.

Example plants

In total, 93 plants worldwide were retrofitted with a three-roll stand between 1977 and 2018. Some European plants equipped with this technology include:

- Acciaierie Valbruna, Bolzano – Italy;
- Liberty Speciality Steels, Rotherham – UK;
- Ascometal, Hagondange – France;
- Saarlöhne, Neunkirchen & Nauweiler & Völklingen – Germany;
- BGH Edelstahl, Freital – Germany;
- Rodaccia, Milan – Italy;
- Acciaierie Bertoli Safu, Pozzuolo del Friuli – Italy;
- ArcelorMittal Steel, Gandrange – France.

Reference literature

[[31, EUROFER 10-7-18 2018](#)], [[68, Ammerling et al. 2005](#)], [[69, Seki et al. 2007](#)].

2.4.8 Cooling lines

2.4.8.1 Optimised water pumps for laminar flows

Description

Optimised cooling water flow control systems are installed in a hot strip mill to accurately control the amount of cooling water supplied to the laminar cooling pump station in order to cool down the rolled strips while optimising water consumption and energy use.

Technical description

In hot strip mills, a series of pumps feed cooling water to a laminar cooling pumping station that is used to provide a continuous stream of water for cooling rolled strips. The cooling water flow control system is composed of pumps equipped with electric motors for suction and delivery of water (servo-drive or variable speed) and water piping for the supply of water to the rolled strip. The strip is cooled using a stream of water delivered both from the top and the bottom in automatic mode, according to cooling strategies for specific technological codes, to coiling temperature, or depending on the hot strip rolling thickness. Generally, the amount of water necessary for cooling is controlled and varies depending on the required outlet temperature of the strip. [[70, EUROFER 31-5-17 2017](#)]

Two main systems are developed for the optimisation of the strip cooling:

- Optimised flow control of the valves with servo-drive, and conventional drives for electric motors.
- Optimised flow control of the pumps with electric motors: variable speed drive (through variable frequency), and conventional valves with on/off control. It is important to note that with the variable speed drive technology, the maintenance required is higher compared to the optimised control-valve technology. In order to ensure uniform cooling of the strip, side water blowers are installed behind each cooling section to remove cooling water from the strip. [\[70, EUROFER 31-5-17 2017 \]](#)

These optimised flow control systems enable the delivery of the exact quantities of cooling water required for cooling rolled strips to the right temperature, thereby reducing water consumption and the energy costs related to pumping water.

Achieved environmental benefits

Reduced energy and cooling water consumption. [\[70, EUROFER 31-5-17 2017 \]](#)

Environmental performance and operational data

No information provided.

Cross-media effects

No information provided.

Technical considerations relevant to applicability

No information provided.

Economics

No information provided.

Driving force for implementation

No information provided.

Example plants

Plants from the data collection: 37 HR, 38 HR, 97 HR, 103 HR3, 106 HR, 110 HR1, 110 HR2, 118 HR, 127 HR, 158 HR, 178 HR, 205 HR, 222 HR, 244 HR, 265 HR.

Reference literature

[\[16, FMP TWG 2018 \]](#), [\[70, EUROFER 31-5-17 2017 \]](#).

2.4.9 Pickling and oiling of hot rolled steel (HRPO)

For techniques to consider in the determination of BAT, see techniques applied in cold rolling (Section 3.4.1) and general techniques reported in Chapter 8 (Sections 8.8.4 and 8.8.7).

2.4.10 Roll shop

2.4.10.1 Recycling of worn working rolls and treatment of grinding sludge

Description

Worn working rolls which are unsuitable for texturing are recycled to iron and steel production or returned to the manufacturer for refabrication. Treatment of grinding sludge is carried out by magnetic separation for recovery of metal particles and recycling of metals, e.g. to iron and steel production.

Technical description

The conditioning of work rolls and back-up rolls used in finishing and roughing mills is carried out in the roll shop where good operational practices are used for solvent usage and management of residues (e.g. recycling or disposal). In the roll shop, work rolls are cooled and reconditioned using a range of cleaning techniques to remove deposits and lubricants. Typical cleaning techniques are steam cleaning, use of alkali solutions or organic solvents for degreasing. For all these operations, good operational practices are implemented concerning the following:

Use of solvents

- As far as technically acceptable for the degree of cleanliness required, water-based degreasing should be applied.
- If organic solvents are used, preference should be given to non-chlorinated solvents.

Management of wastes and residues

- Grease removed from roll trunnions is collected and disposed of properly (e.g. by incineration).
- Grinding sludge is treated by magnetic separation for recovery of metal particles which are recycled into the steel-making process.
- Steel and iron turnings are recycled into the steelmaking process.
- Worn rolls which are unsuitable for further reconditioning are recycled into the steel-making process or returned to the manufacturer for refabrication.
- Cooling liquids and cutting emulsions are treated for oil/water separation. Oily residues are disposed of properly (e.g. by incineration).
- Waste water effluents from cooling and degreasing as well as from emulsion separation are recovered by the hot rolling mill water treatment plant.

Achieved environmental benefits

Reduction of the overall environmental impact.

Environmental performance and operational data

No information provided.

Cross-media effects

No information provided.

Technical considerations relevant to applicability

Generally applicable in roll shops.

Economics

No information provided.

Driving force for implementation

No information provided.

Example plants

Widely used.

Reference literature

[[16, FMP TWG 2018](#)].

2.4.11 Water treatment and waste water generation

2.4.11.1 Semi-closed and closed water circuits

Description

Semi-closed and closed loop water circuits are used in hot rolling mills to reuse the process and cooling water after treatment and to minimise water consumption.

Technical description

A technical description of semi-closed and closed loop water circuits, with discharge as low as possible, is provided in Section 2.2.17.

Achieved environmental benefits

- Reduction of waste water and pollutant discharge.
- Reduction of water consumption.

Environmental performance and operational data

No information provided.

Cross-media effects

- Increased energy consumption and consumption of chemicals.
- Waste (sludge) generation.

Technical considerations relevant to applicability

In some cases, upgrading existing plants from ‘wet mills’ (once-through) to mills equipped with semi-closed or closed water circuits is not possible owing to insufficient space for installing a waste water treatment plant.

Economics

Investment costs strongly depend on factors such as the existing infrastructure, secondary cooling water quality or local climatic conditions. [\[25, EUROFER 2018 \]](#)

Driving force for implementation

No information provided.

Example plants

Widely used.

Semi-closed: No information provided.

Closed: ArcelorMittal Bremen, U.S. Steel Košice

Reference literature

[\[16, FMP TWG 2018 \]](#), [\[25, EUROFER 2018 \]](#).

2.4.11.2 Treatment and reuse of scale- and oil-bearing process water in hot rolling

Description

Scale- and oil-bearing waste water from hot rolling mills is treated separately using different cleaning steps including scale pits, settling tanks, cyclones and filtration to separate oil and scale. A large proportion of the treated water is reused in the process.

Technical description

Scale- and oil-bearing waste water from hot rolling (and often from continuous casting) is treated using different cleaning steps, for example scale pits, settling tanks, cyclones, filtration, etc., creating relatively complex waste water treatment systems. The first step is usually a scale pit to remove the coarse scale by sedimentation. This is followed by several secondary or fine

cleaning steps aiming at separating and abating oil and the remaining scale. Treated water is recirculated to the various processes and reused, at rates that can be over 95 %. As there are numerous options for combining the individual cleaning steps, the treatment of scale- and oil-bearing process waters and the achievable emission levels are described by means of examples of water treatment systems implemented in hot rolling mills.

In most cases, coarse scale is captured close to the spot where it arises by **scale pits**, small gravity separators, to prevent installations from damage, e.g. if it is necessary to transport the scale-loaded water by pumps. Scale pits can reduce the content of suspended solids in the waste water (load of 20–40 m³/(m²h)) from 200–800 mg/l to 60–100 mg/l. The advantage of decentralised scale arresting is that there is no sedimentation in the flume channels and less corrosion takes place.

For further coarse cleaning (intermediate cleaning), the water is usually physically treated in settling tanks to separate coarse scale and hydrocarbons. Different designs are available, e.g. vertical and horizontal flow **settling tanks**. Figure 2.102 and Figure 2.103 depict examples of gravity separators.

The basic principle of these separators is that coarse particles settle on the bottom of the basin by gravity, while the major part of the oil dispersed in the water rises to the surface. The water is discharged via an outlet equipped with a submerged barrier in front to prevent the oil floating on the surface from being discharged with the purified water. The deposited sediments are usually conveyed to a sump by scrapers where they can be removed by excavators or pumps.

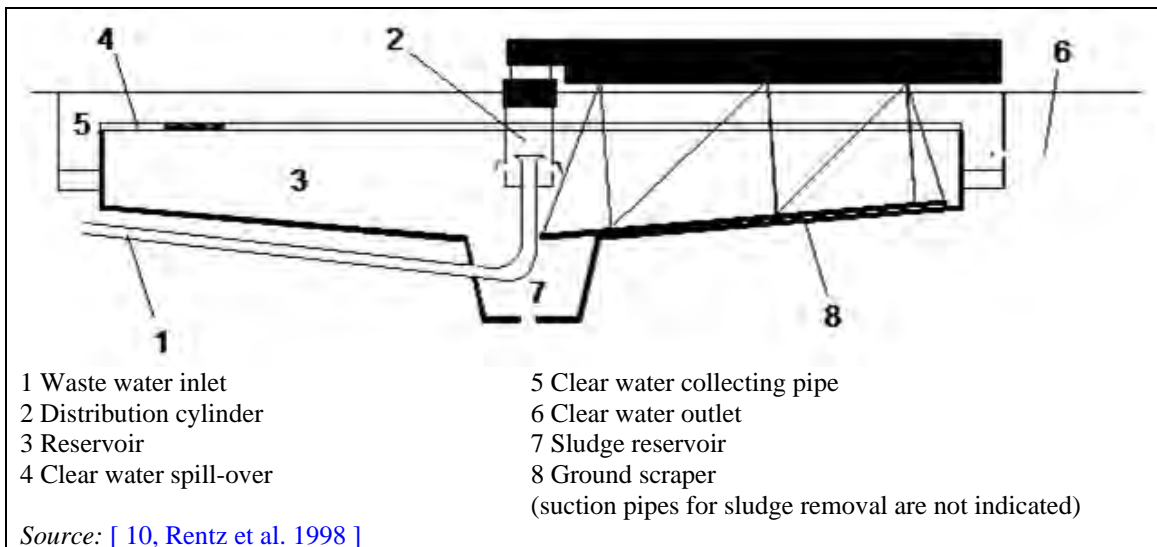


Figure 2.102: Circular settling tank (vertical)

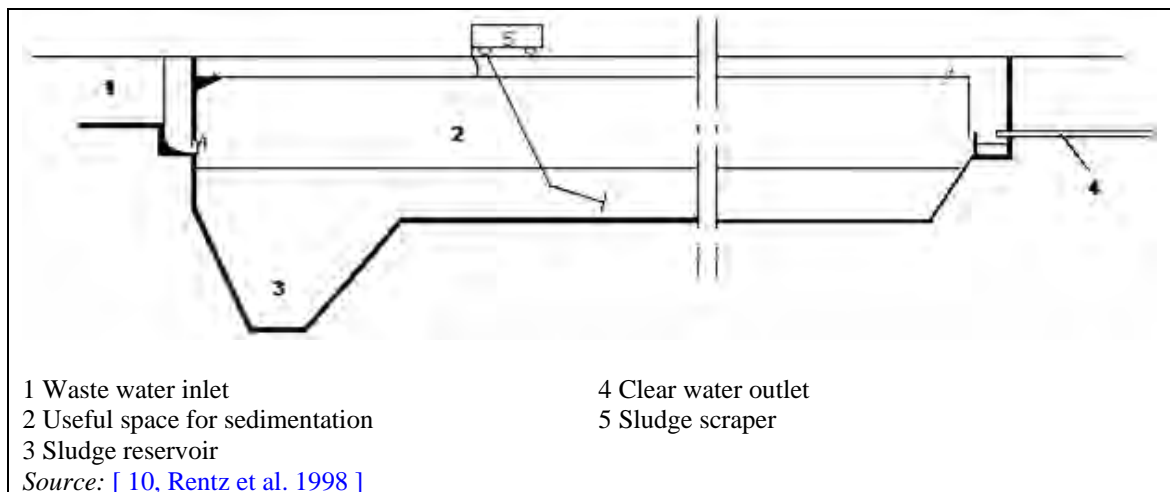


Figure 2.103: Horizontal flow settling tank

The achievable reduction depends on tank size, particle size distribution, addition of flocculating agents and oil content. Settling tanks can reduce suspended solids from 40–80 mg/l down to 20–35 mg/l (load 4–15 m³/(m²h)).

Other types of gravity separators are **screw-type clarifier (or screw-type dewaterer)** and **lamella separator**. Compared to settling basins, they have a more compact construction. In lamella separators (Figure 2.104), the incoming water is led over a number of inclined plates (lamellas). The settling distance is much shorter. The settlements are forced down along the plates by gravity, while the oils move upwards along the underside of the plates and can be collected by skimming mechanisms. The purified water is discharged through an outlet, which is separated from the basin by a submerged barrier. The sediment is discharged from the bottom e.g. via a screw, which is also separated from the main basin by a submerged barrier.

Screw-type clarifiers (see Figure 2.105) are basically settling tanks with an inclined bottom. The solids settling by gravity are transported out of the separator by a rotating screw, partially submerged in the sediment.

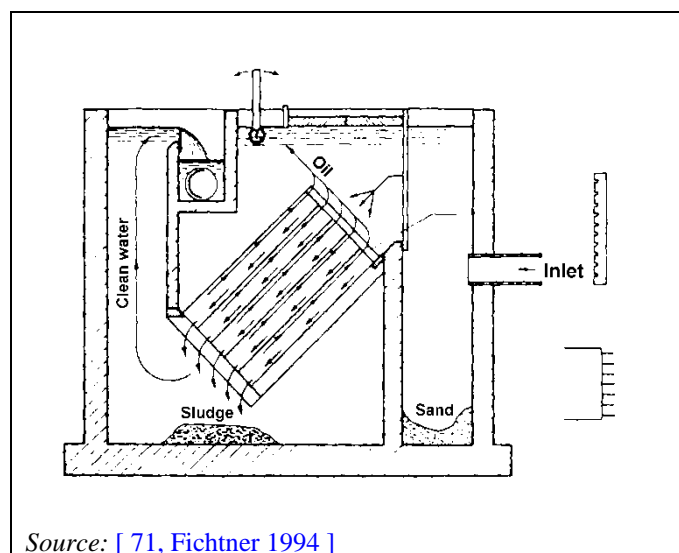
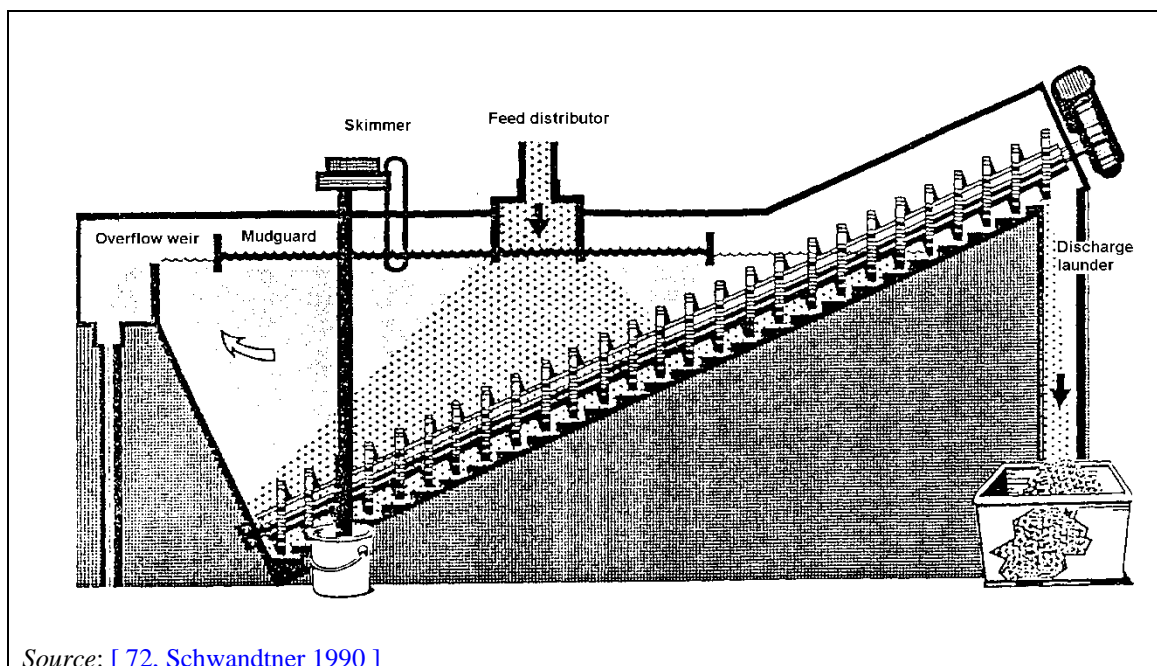


Figure 2.104: Schematic of a lamella separator



Source: [72, Schwandtner 1990]

Figure 2.105: Screw-type clarifier

In **centrifugal separators** the scale particles are pressed to the wall by the flow. On the wall of the separation chamber, the scale particles glide slowly downward to the collecting chamber. When the collecting chamber is full, automatic elutriation starts. A disadvantage of this method is the fact that oil separation is not possible.

Oil floating on water surfaces is removed by **oil skimmers**. The oil adheres to an endless strip or hose, which is immersed in the basin. Together with this strip or hose the oil is transferred to a funnel outside of the basin where it is skimmed from the strip. A wheel can also be used instead of the endless strip.

Fine cleaning can be carried out in **gravel or sand filters** (Figure 2.106). The water flows through the filter medium from the top to the bottom. Thus large amounts of scale, sludge and oil are retained. Depending on the cleaning system these filters can remove all particles carried by the water down to a grain size of 1 micron. The cleaned but still thermally loaded water is cooled in cooling towers in order to achieve the right temperature for recirculation. Gravel and sand filters need to be cleaned in order to remove particles and hydrocarbons. The filters are backwashed after a fixed period or when a defined filter resistance has been reached. Backwashing is performed with water or air. The required volume of backwash water amounts to about 1–3 % of the cleaned water.

Some sand filters are operated with continuous backwashing. Here the water flows through the filter medium from the bottom to the top. The sand is continuously transported upwards and constantly washed. The purified sand falls on top of the clean sand bed.

The backwash water is usually highly contaminated and is either treated in the pre-cleaning units, if necessary under addition of flocculating agents; or is treated separately in special sludge treatment units.

For **treatment of backwashing water** from the sand filters, the water is thickened in a thickener by adding flocculents and applying sedimentation techniques. The flocculent is added and mixed with the backwash water in a pre-reaction chamber. In the central chamber the sludge settles down. The purified water is discharged through an indented weir and is returned to a sand filter system. By means of a scraper the sludge is transported to the sludge sluice, where it is discharged.

If the arising sludge contains too much water, a press can be used for further dewatering. Such a press can be designed as a chamber filter press, a membrane filter press or a solid bowl centrifuge. The filtered water is recirculated to the thickener. [4, EUROFER 1998]

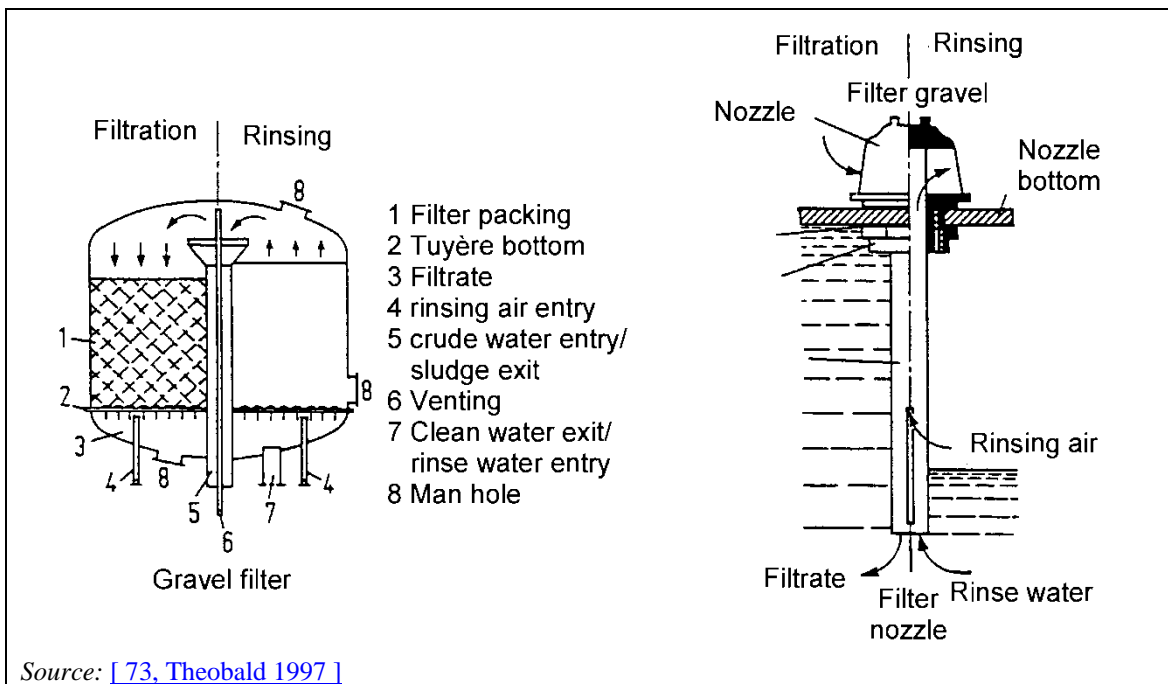


Figure 2.106: Example of a gravel filter showing in detail the backwash operation

Another option for fine cleaning the pre-cleaned waste water is filters that consist of cylindrical, wire-netting filtering elements (see Figure 2.107).

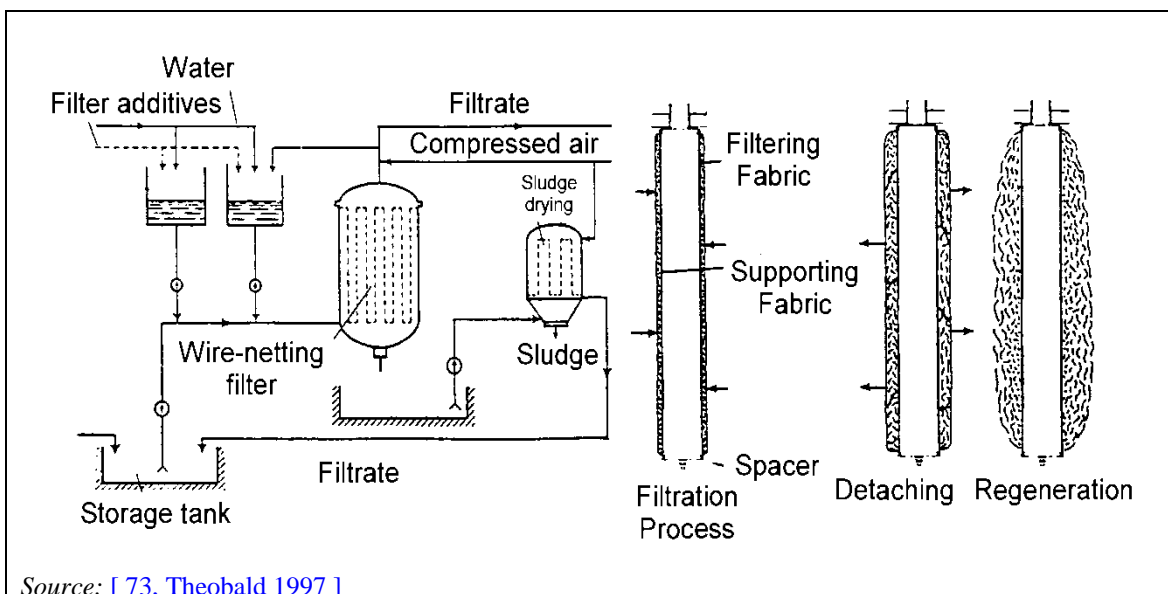


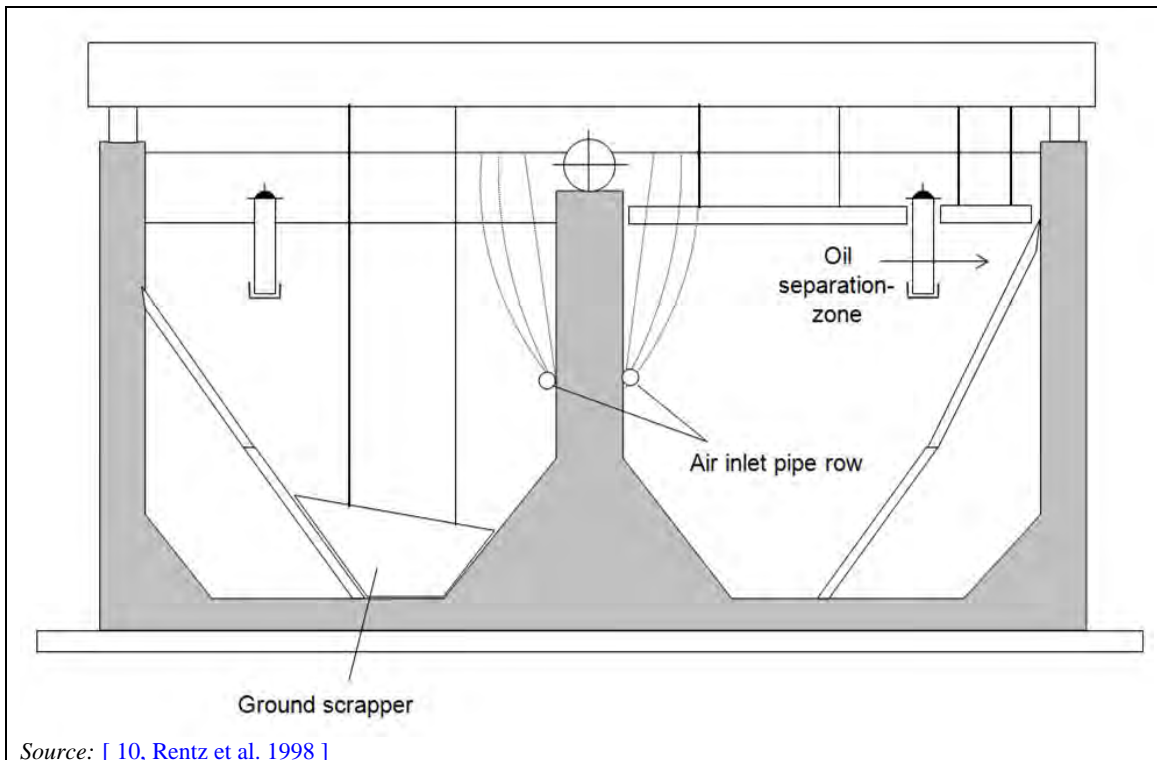
Figure 2.107: Example of wire-netting filters showing in detail the backwash operation

Operation cycles of these filters are divided into:

- starting phase during which a layer of filtration aid is built up on the fine meshed filters;
- filtering phase during which further filtration aid is added to keep the filtrate and sludge layer permeable;
- backwashing phase during which the filters are cleaned by reversing the flow direction.

Sludges obtained from backwashing can be dewatered directly and require special treatment prior to reuse (e.g. in the sinter plant) only if they have a high oil content. [73, Theobald 1997]

For a more efficient intermediate cleaning and enhanced separation of scale and oil, so-called **aerated fine scale-traps** have been developed as shown in Figure 2.108. These combine the principles of sedimentation and flotation. The solids settle on the bottom and are removed by scrapers, while the air blown in (air bubbles) enhances the flotation of the oil.



Source: [10, Rentz et al. 1998]

Figure 2.108: Aerated fine scale-trap

Furthermore, the oil adsorbed by the fine scale is 'washed off' by agitation. Due to the better separation of oil and scale and the lowered oil content of the scale, the recycling options are improved. With retaining times of 15 to 30 minutes and loads of 15–20 m³/(m²h), aerated fine scale-traps can achieve reduction rates of 99 % for particles > 63 μm and 20–80 % for particles sized 31–63 μm (depending on the particle size distribution). [10, Rentz et al. 1998], [73, Theobald 1997]

Table 2.26: Example of achieved emission levels for aerated fine scale-traps

	Inlet [mg/l]	Outlet [mg/l]	Reduction [%]
Suspended solids	32.3	25.8	20.1
Settleable solids	95.5	44.2	53.7
Fe total	43.5	24.6	43.4
Hydrocarbons¹	2.0	1.3	35.0

Source: [74, Dammann et al. 1994]

¹ Determined according to DIN 38 409, part 18, 1981

Reducing oil and grease content by using aerated fine scale-traps as a precleaning device upstream of gravel or sand filters can improve the operation of the filters. The backwashing intervals are increased as the particle load is reduced and clogging of filters due to oil and grease is minimised. [75, Batisch et al. 1996]

Mill scale has a high magnetic susceptibility and can thus be removed by **magnetic filtration** (see example in Figure 2.109). A coil creates a magnetic field in which the steel casing of the filter and a matrix of filament material are also magnetised (amplification); due to the high gradients, small ferromagnetic particles such as mill scale fines are attracted.

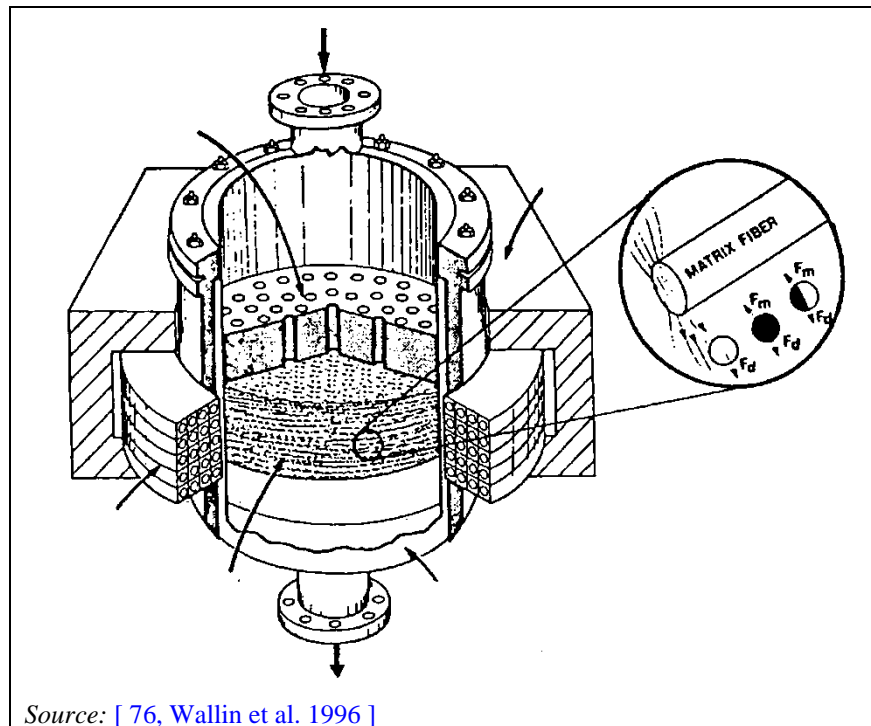


Figure 2.109: Magnetic filtration (example high gradient MF)

Achieved environmental benefits

- Reduction of pollutant discharge to water, especially suspended solids, oil and grease.
- Reduction of water consumption.
- Reduction of the volume of waste water generated.

Environmental performance and operational data

Example A: SSAB

The major portion of scale and oil is separated in two scale pits near the rolling mill. The water treatment plant has three basins for gravimetric separation of scale and surface separation of oil and grease. The final cleaning is done using 10 sand filters. The rate of water circulation has gradually been increased over the past years to reduce water discharge to the river to below 200 m³/h (previously: 3 500 m³/h, recirculation rate approximately > 95 %). Additionally, primary measures have been taken to reduce leakage of, for example, grease, lubricants and hydraulic oils from machine equipment. Hoses have been changed, better couplings have been installed and routine inspections are carried out. [77, Andersson 1995]

Achieved discharge values are 0.4 mg/l for oil (0.7 t/yr) and 3.8 mg/l for suspended solids (6 t/yr) (reference year 1994, monthly mean value). [77, Andersson 1995]

Example B: ArcelorMittal Bremen

Figure 2.110 shows the water circuit and the water treatment system installed at ArcelorMittal Bremen. The system treats an average water flow of 18 000 m³/h including 3 500 m³/h from the roughing mill and 14 500 m³/h from the finishing train (including water from the delivery roller table, the coiler and the mist extraction system). The coarse scale is removed from the roughing mill process water in scale pits before it is treated together with the stream from the finishing train in aerated fine scale traps followed by settling tanks. Before the water is recirculated and

split into different quality streams, it is cleaned in sand filters. These consist of three groups of pressure filters; operating at full production capacity, the filtering speed is 21.4 m³/h. The reduced concentration of suspended solids, iron and hydrocarbons is shown in Table 2.27. [75, Batisch et al. 1996], [78, Dammann 1994]

Table 2.27: Pollutant concentration in the water circuit

Substance	Scale pits, aerated fine scale trap, settling tank	Sand/Gravel filter		
	Outlet [mg/l]	Inlet ¹ [mg/l]	Outlet [mg/l]	Reduction [%]
Suspended solids	40 – 70	36	3.5 ~ 3.8	90
Iron	10 – 20	7.7	0.85	90
Hydrocarbons	1 – 2	1.7	0.5 ~ 0.6	65

¹ Average inlet concentration.

Source: [75, Batisch et al. 1996]

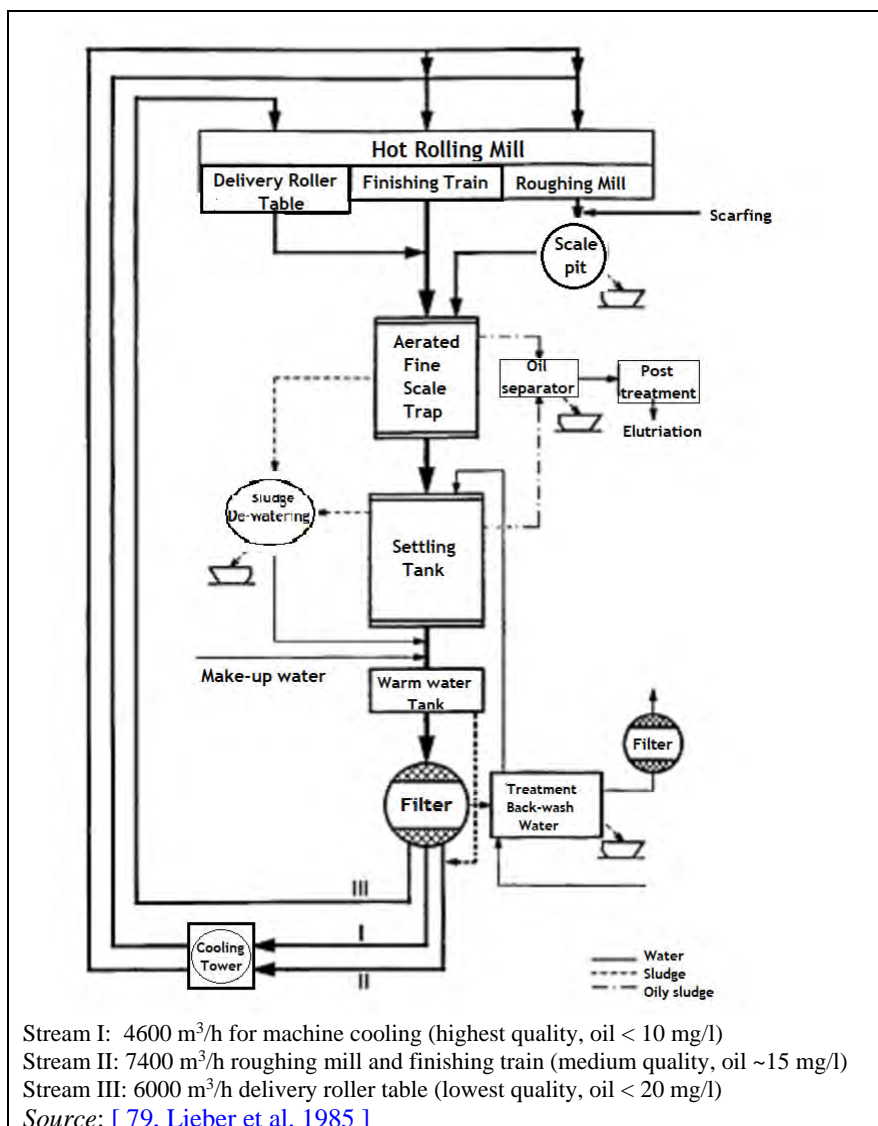


Figure 2.110: Example of a water recirculation system for a hot rolling mill

To make up for evaporation losses and elutriation water, water from the LD steel plant or – in case of production stop - roughly filtered water from a river is added to the system. The amount of elutriation water, which needs to be withdrawn from the system to avoid salt built-up, is

mimimised by reuse for backwashing sand filters and by partial reuse in slag processing. [75, Batisch et al. 1996], [78, Dammann 1994]

From filter backwashing, about 750 m³/h arise which are treated as shown in Figure 2.111, about 92 % of the solids settle in the sedimentation step; the remaining suspended solids (approximately 50 mg/l) and the hydrocarbons (average 1.5 mg/l) are treated by flocculation and flotation. The water is then recirculated to the water system. The partial stream which has to be discarded is treated in two-layer filters. The concentration of suspended solids and hydrocarbons are well below the emission limit values set by authorities (10 mg/l SS and 1 mg/l HC). Achieved emission levels are shown in Table 2.28.

For maintaining the water circuit, biocides, corrosion inhibitors and dispersing agents are added. When needed (e.g. once a day), flash chlorination is carried out.

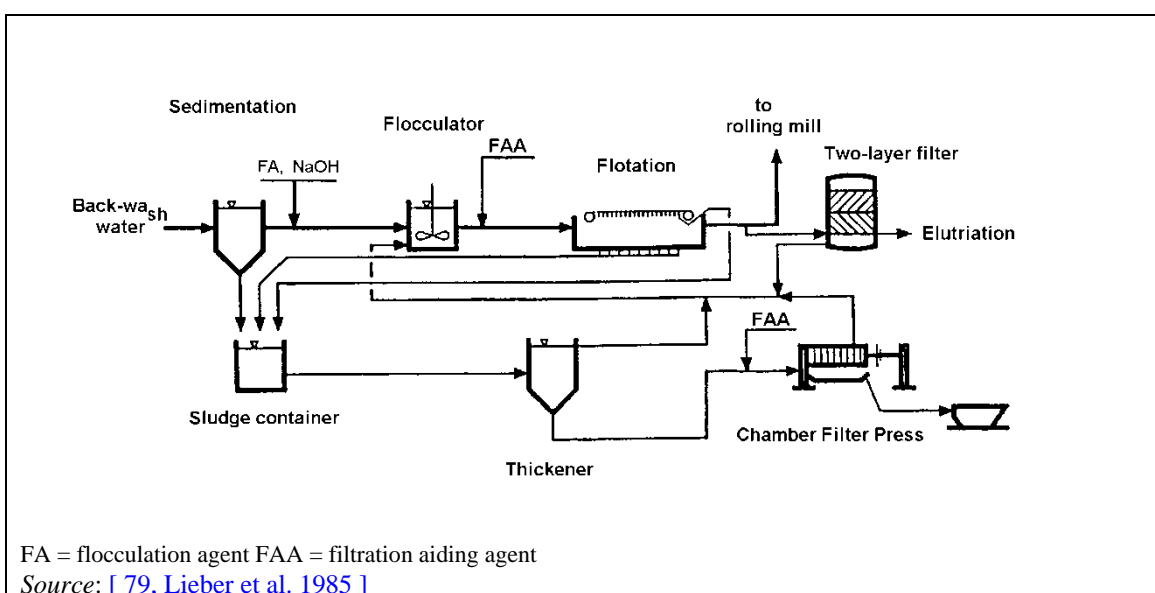


Figure 2.111: Treatment of backwashing water

Table 2.28: Concentration of effluents from treatment of backwashing water

Substance	Concentration in mg/l	Type of sampling	Measurements in 1998 Operator/Comp. authority
Fe	0.13	Qualified random sample	12/6
Oil	< 0.1	Qualified random sample	12/6
Suspended solids	< 3	Qualified random sample	12/6
Cr	< 0.01	Qualified random sample	12/6
Ni	0.02	Qualified random sample	12/6
Zn	0.03	Qualified random sample	12/6

Note:

Mean values of the qualified random samples from 1998. Waste water volume: 1620404 m³

Source: Senator für Bau und Umwelt Bremen. Plant: ArcelorMittal Bremen. [80, DE, TWG member 2000]

Example C: ArcelorMittal Ghent

The water circuit installed at ArcelorMittal Ghent basically consists of three systems: the 3-bar system for cooling the supporting rolls, the roll table and the motors; the 12-bar system for cooling of the work rolls and for feeding of the descaling pump system and the 150-bar system for descaling at the furnace exits and in the roughing and finishing mill. The total flow is up to 13 000 m³/h.

Oil- and scale-bearing water from the 150-bar system is cleaned in a first step by scale pits followed by gravity sand filters. The process water from the roughing mill contains mainly large scale, less than 20 % of the oil and grease consumed, does not require cooling and can be reused in the 3-bar system without further treatment. Water from the finishing mill contains fine scale and over 80 % of the oil and grease consumed. Following the decanters and the sand filters, this water needs to be cooled before it is reused in the 3-bar system. The reused channel water contains less than 5 mg/l suspended solids and less than 0.2 mg/l hydrocarbons.

Due to evaporation losses and high contents of Na, Cl, etc., about 500 m³/h of refreshing water is needed, which is taken from the cold rolling mill. The elutriated water exits to the steel mill.

The reutilisation rate of the system described is over 95 %.

The efficiency of the waste water treatment and thus the pollutant concentration discharged depend among others on the combination of individual cleaning operations. Table 2.29 lists more example of water treatment sequences and achieved emission levels.

Table 2.29: Pollutant reduction for several waste water treatments

Results of waste water treatment		
Before Treatment	Treatment	After treatment [mg/l]
Oil/Grease: 10 -200 mg/l 0.7 - 2.73 kg/t Suspended solids (SS): 120 – 2000 mg/l 0.13 - 4.57 kg/t	Example E Sedimentation + flocculation, flotation + sand filter	Oil: 50 SS: 50
	Example F Sedimentation + flocculation + cooling + sand filter	SS: < 10 Oil: <5 Fe: 12 Ni, Cr, Cu, Zn, Pb, Cd: < 0.1
	Example G Sedimentation + flocculation + cooling + magnetic filtration ¹	Reduction: SS: 90 % (down to 3 - 9 mg/l) Oil: 50 - 90 %
	Example B' Sedimentation + aerated sinter removal + flotation + sand filter, blow down: biological polishing	Reduction: SS (>63 µm): > 99 % 31 < SS <63 µm): 20 - 80 %:
	Example H Cyclones, settling basin, sand filter, cooling towers	Oil: 50 (= 20 g/t) SS: 50 (= 20 g/t) COD: 100
¹ Concentration before treatment: 30 - 100 mg suspended solids/l Source: [81, Haskoning 1993]		

Cross-media effects

Oil and sludge arise as waste in waste water treatment. [82, DE, TWG member 1999]

Technical considerations relevant to applicability

Generally, there are no technical restrictions to the applicability of this technique.

Economics

No information provided.

Driving force for implementation

Environmental legislation.

Example plants

Widely used.

Reference literature

[4, EUROFER 1998], [10, Rentz et al. 1998], [16, FMP TWG 2018], [73, Theobald 1997], [75, Batisch et al. 1996], [77, Andersson 1995], [78, Dammann 1994], [82, DE, TWG member 1999].

2.5 Emerging techniques for hot rolling

2.5.1 Organic Rankine Cycle (ORC) – Heat recovery from the exhaust gases of rolling mill reheating furnaces

Description

Low-grade heat from the exhaust gases of hot rolling reheating furnaces is converted into electricity using high-molecular-weight fluids.

Technical description

General principles of the Organic Rankine Cycle

In a conventional Rankine Cycle, a working fluid (usually water) is heated to saturation in a boiler, the water vapour expands through a turbine while producing work, returns to the liquid state in a condenser, and is pumped back into the boiler to repeat the cycle.

In an ORC, high-molecular-mass organic fluids are used instead of water as the working fluid. In general, the types of working fluids used are siloxanes or hydrocarbons. These fluids exhibit much lower boiling points than water. The working fluid is vaporised in a heat exchanger using the heat from waste flue-gases. The working fluid changes into a gaseous state and expands in a turbine directly connected to a generator to produce electricity. The working fluid is condensed in a water-cooled condenser and pumped back to the heat exchanger. ORC are used to generate electrical power using low- to medium-temperature heat sources (e.g. low-grade heat), typically in the range of 80 °C to 350 C.

The process to capture the waste heat and generate electrical power in an ORC system is depicted in Figure 2.112. The different steps are: [\[31, EUROFER 10-7-18 2018 \]](#)

- hot exhaust gases are passed through the heat exchanger;
- in the heat exchanger, heat is transferred from the hot exhaust gases to the organic working fluid such as silicone oil (hexamethyldisiloxane), hydrocarbons or fluorinated refrigerants; [\[83, Foresti et al. 2016 \]](#)
- the hot working fluid is pumped to the heat recovery evaporator in the ORC system;
- the working fluid is boiled in the ORC evaporator and fed to an expander turbine which drives the electrical generator;
- the turbine generator generates electrical power which is fed to the plant distribution network;
- the exhaust refrigerant is condensed using plant water as a heat sink and pumped back to the evaporator to repeat the cycle;
- the master controller monitors all the relevant parameters and variables of the ORC process including flow, pressure, temperature and electrical power, but also controls the variable speed pumps for optimum thermal efficiency.

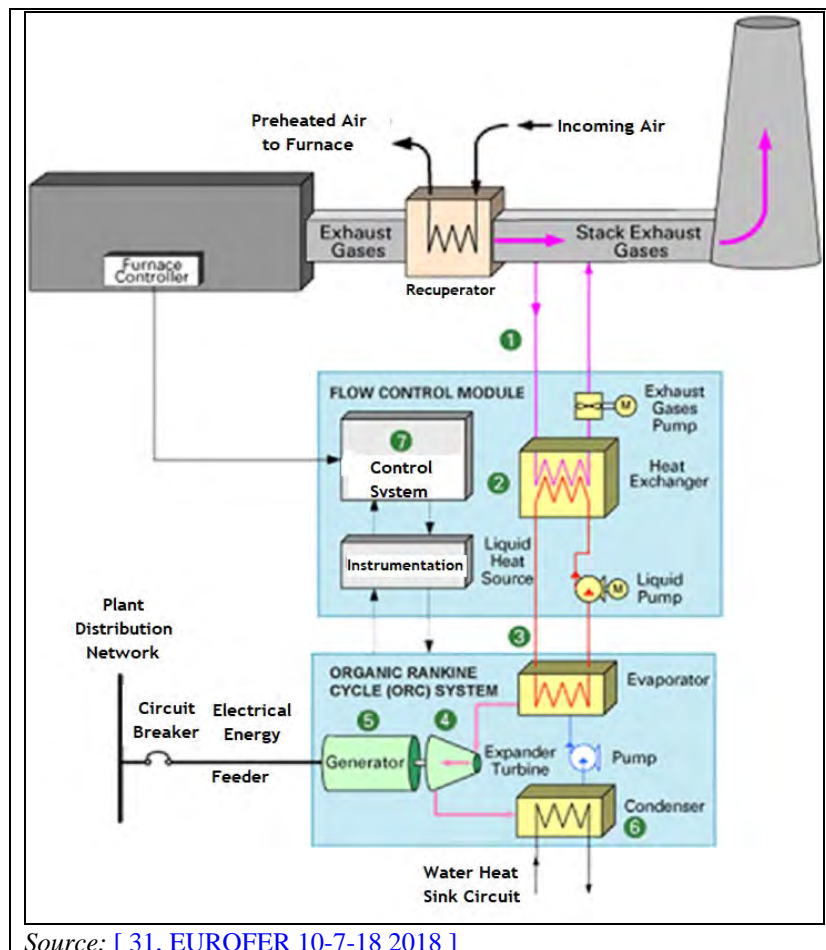


Figure 2.112: Schematic of an Organic Rankine Cycle

Application of the ORC technique to hot rolling mills reheating furnaces

In hot rolling mills, reheating furnaces are employed to reheat billets, blooms or slabs from ambient temperature or from approximately 800 °C in the case of hot charging up to 1 250 °C. The most important types of reheating furnaces are pusher-type furnaces or walking beam furnaces. In these furnaces, between 20 % and 30 % of the energy input is typically wasted through the wall and door losses but also through the exhaust gases. Typically, the temperature of the exhaust gases between the combustion air recuperator and the stack is within the range of 250-400 °C.

The first application of heat recovery by ORC from reheating furnaces in hot rolling mills was started in April 2013 in Singapore. The heat from the exhaust gases of the reheating furnace (at a temperature of about 400 °C) is captured via a heat exchanger in the ORC plant. The working fluid is an organic fluid (hexamethyldisiloxane). After recovery in the ORC system, the exhaust gas temperature is within the range of 130-150 °C before being released to atmosphere via the stack. As a result, the heated-up working fluid changes into a gaseous state and expands into a turbo-expander that is directly connected to a generator to produce electricity [85, Wong 2013]

A second application of heat recovery using an ORC system to generate electricity was reported at a hot rolling mill in Germany for a pusher furnace as starting in 2014 (Badische Stahlwerke GmbH (Plant 140 HR – data collection). [84, Menges et al. 2017]

Achieved environmental benefits

Increased energy efficiency.

Environmental performance and operational data

At NatSteel rolling mill, the cumulative electricity generated during a test period of 37 days with an ORC system of 700 kW capacity was 109 390 kWh. [[85, Wong 2013](#)]

In 2017, approximately 60 000 kWh per year was saved at Badische Stahlwerke GmbH following the installation of the ORC system. However, more than 1 400 000 kWh energy savings were expected but could not be achieved because of plant engineering problems. [[84, Menges et al. 2017](#)]

Cross-media effects

None identified.

Technical considerations relevant to applicability

Generally, there are no technical restrictions to the applicability of this technique.

Economics

Globally, a potential recovery of 310 MW of energy was estimated if ORC plants were installed at 209 rolling mills across the EU-27. [[86, Campana et al. 2013](#)]

At NatSteel rolling mill plant reheating furnace, the ORC plant installation costs were USD 3.7 million with net annualised energy savings ranging between USD 650 000 and USD 750 000 per year. [[85, Wong 2013](#)]

Driving force for implementation

Supply of electricity to the plant distribution network.

Example plants

- NatSteel rolling mill reheating furnace in Singapore. [[83, Foresti et al. 2016](#)], [[85, Wong 2013](#)]
- Badische Stahlwerke GmbH (Plant 140 HR – data collection).

Reference literature

[[31, EUROFER 10-7-18 2018](#)], [[83, Foresti et al. 2016](#)], [[84, Menges et al. 2017](#)], [[85, Wong 2013](#)], [[86, Campana et al. 2013](#)].

2.5.2 Electrical welding of billets using water spays and a spark killer device for suppression of fugitive dust emissions

Description

Electrical welding of billets is carried out without the use of any external chemical element for the fusion process and using water sprays in combination with a spark killer device for fugitive dust emissions suppression.

Technical description

Generally, the jointing of billets is realised using an electrical current passing through two billets placed in contact with clamps of conductive material (copper alloy). In the electrical welding process, the fusion of the material and the consequent jointing of the billets is carried out without the contribution of any external chemical element to those already present in the billets.

Also, this technique does not require the use of gas compounds and it employs a spark killer device in combination with water sprays to reduce fugitive dust emissions. Because of these specificities, this billet welding process is different from all other conventional welding processes.

During the jointing, which is an intermittent process lasting about 12 seconds, the spark killer device installed on the electrical welding device moves downward to the position of the joint in order to confine electrical sparks and fumes. At the same time, the jointing zone is sprayed with a relatively high quantity of cooling water that contributes in a very efficient way to reduce fugitive dust emissions. [87, PT 2021]

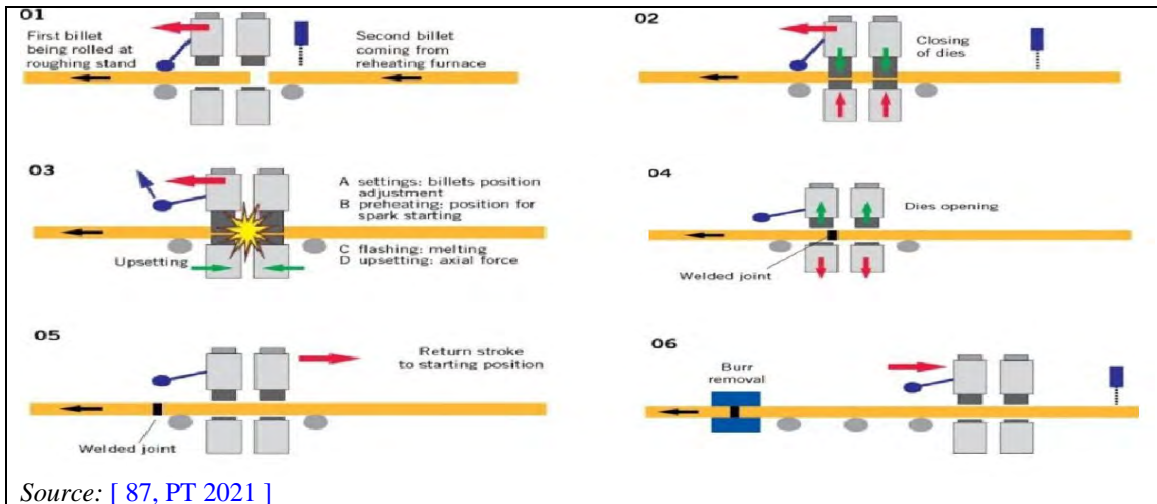


Figure 2.113: Schematic showing the principles of the electrical welding of billets using water sprays in combination with a spark killer device for suppression of fugitive dust emissions.

Achieved environmental benefits

Reduction of fugitive dust emissions.

Environmental performance and operational data

Due to the efficient functioning of the spark killer device in combination with water sprays, no significant particulate emissions occur during the electrical welding process of billets. Consequently, plants employing such welding technique are not equipped with extraction and abatement for capturing and reducing fugitive dust emissions.

Depending on the size of the billets, the electrical welding system consumes an average of 2 kWh for each weld.

Some waste materials are generated including the welding sparks, the burrs of the joint cleaning device (which are chunks of steel of the same chemical composition as the billets). The wastes generated are collected using a dedicated conveyor and can be fully recycled into the steel plant. In addition, one of the advantages of the electrical welding technique is to reduce the head and tail cuts during rolling, thus reducing the overall amounts of steel waste.

The electrical welding system is installed on a car which allows the equipment to be moved aside for maintenance operation in safe conditions. The spark killer device is self-cleaning using four blades and a dedicated cleaning cycle. The electrical welding system is usually installed in an enclosed area without any workers nearby.

Overall, the water sprays use 11 m³/h of cooling water, which is a negligible quantity in a rolling mill. The cooling water can be reused in the open cooling water circuit of the rolling mill. [87, PT 2021]

Cross-media effects

None reported.

Technical considerations relevant to applicability

- Generally applicable for welding steel billets.
- The technique may also be applicable to other types of ferrous metallic welding.

Economics

No information provided.

Driving force for implementation

Prevention of fugitive dust emissions.

Example plants

- Alfa Acciai (Italy, installed in 2019).
- Alpa (France, installed in 2018).
- Ferriere Nord (Italy, installed in 2016).
- ESF Elbe-Stahlwerke Feralpi (Germany, installed in 2021).

Reference literature

[87, PT 2021].

3 COLD ROLLING

3.1 General information on cold rolling

3.1.1 Cold rolled flat products

The total production of cold rolled products in 2019 was 43.0 million tonnes in the EU-27 and the United Kingdom.

Cold rolled strip production can be divided into different production sectors: cold rolling narrow hot strip with a width of less than 500 mm and cold rolling wide hot rolled sheet and subsequent slitting. Around two thirds of the total narrow strip requirement in the EU is produced by slitting wide sheet. [[88, Beddows & Co. 1995](#)]

Table 3.1 gives the production of cold rolled sheet and strip for a number of EU Member States and the United Kingdom. The number and production capacity for the two main types of cold rolling mills operating in the EU (i.e. reversing and tandem mills) is shown in Table 3.2.

Table 3.1: Cold rolled sheet and strip production in 2019

	Production of cold rolled sheet and strip [thousand t]
Austria	3 071.5
Belgium	5 155.3
Bulgaria	0
Czech Republic	42.7
Denmark	0
Finland	1 296.8
France	5 095.4
Germany	10 513.7
Greece	0
Hungary	397.2
Italy	5 146.2
Luxembourg	0
Netherlands	2 732.1
Poland	984.2
Portugal	321.2
Romania	512.2
Slovakia	1 907.9
Slovenia	8.9
Sweden	822.7
Spain	3 311.2
UK	1 682.8
Total	43 002.6
NB: Reference year 2019. Source: [1, EUROFER 2021]	

Table 3.2: Number and nominal capacity of CR mills in the EU (reversing/tandem mills)

Cold rolling mill type		Total	Nominal capacity range (t/h)								
			0-19	20-39	40-59	60-79	80-99	100-119	120-149	150-199	200-299
Reversing mill	Nominal capacity (t/h)	1266	551	425	46	129	0	114	0	0	0
Reversing mill	Number of installations	96	78	14	1	2	0	1	0	0	0
Tandem mill	Nominal capacity (t/h)	6155	15	73	197	616	88	342	1418	872	2533
Tandem mill	Number of installations	49	3	3	4	9	1	3	10	5	11

NB: Reference year 2019.
Source: [\[1, EUROFER 2021 \]](#)

3.2 Applied processes and techniques in cold rolling

3.2.1 Process overview

In cold rolling, the properties of hot rolled strip products, e.g. thickness, mechanical and technological characteristics, are changed by compression between rollers, normally without previous heating of the input. Previous hot strip annealing may be carried out in some cases. The input is obtained in the form of coils from hot rolling mills.

The processing steps and the sequence of processing in a cold rolling mill depends on the quality of the steel treated. **Low-alloy and alloy steel (carbon steels)** processing usually follows the order: pickling, rolling, annealing, temper rolling/skin pass rolling and finishing.

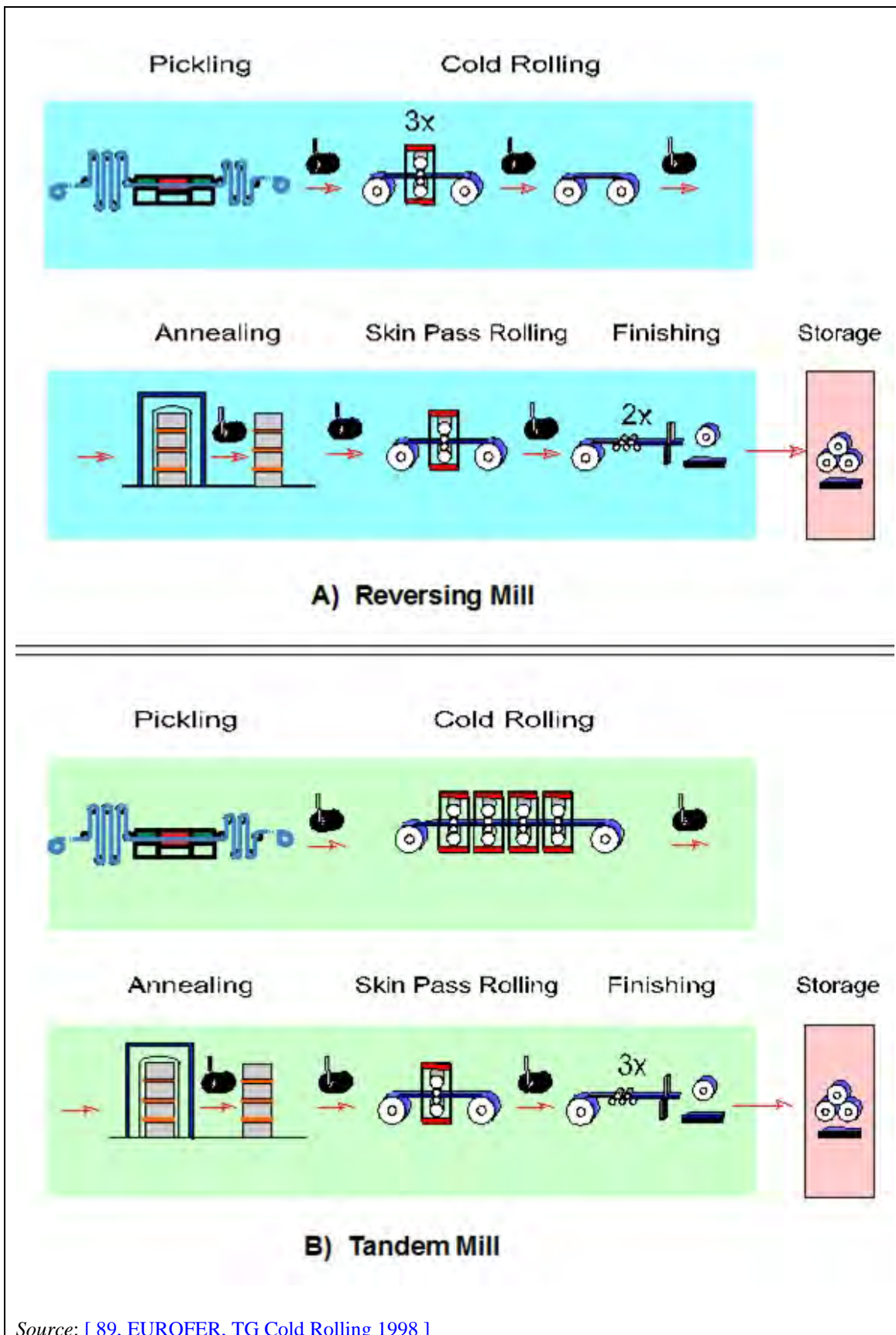
The process route for **high-alloy steel (stainless steel)** requires an initial annealing step prior to pickling due to the hardness of the steel quality and, furthermore, several additional annealing and/or pickling steps during rolling may be necessary.

Cold rolled products are mainly strips and sheets (thickness typically 0.16–3 mm) with a high-quality surface finish and precise metallurgical properties for use in high-specification products.

Cold rolling mills (CR strip mills)

Typical layouts for cold rolling mills are shown in Figure 3.1. The plants usually comprise the following:

- **Continuous pickling line**, where the oxide layer formed during the hot rolling is removed by pickling with sulphuric, hydrochloric or a mixture of nitric and hydrofluoric acid. A stretcher leveller or an in-line skin pass may be used to improve the shape of the strip and to mechanically break the oxide layer.
- **Cold rolling mill** generally consisting of a 4-stand or a 5-stand four-high tandem mill or of a four-high reversing mill. Alternatively, six-high stands may be used, which improve the flatness control. Cold rolling reduces the initial thickness of the hot rolled strip by typically 50–80 % (up to 90 % is also achievable).
- **Annealing facilities** to restore the ductility by recrystallisation of the steel strip that is lost as the result of work hardening during the cold rolling or, in some cases, to normalise the steel strip at temperatures of 950 °C for example to obtain a equiaxed fine-grained microstructure. [\[3, EUROFER 2020 \]](#)
- **Temper mills** to give the annealed material the required mechanical properties (prevent the formation of Lüders lines during drawing) and the required surface roughness. The material is subject to a slight skin pass rolling, typically on a four-high skin pass mill and sometimes on a six-high skin pass mill. The roughness of the work rolls of the mill is transferred to the strip by the roll pressure. The temper mill also provides the final flatness of the product.
- **Inspection and finishing lines**, where coils with different lengths may be welded together to meet the required weight or may be slit to the required width. Also, coils are cut into sheets with the required length and width. At the same time, defective sections of strip can be discarded. Inline tension levellers may be used as well as strip oiling devices for rust prevention.
- **Packaging lines for coils or sheets** according to the destination and/or the means of transport.
- **Roll shop**, where the work rolls and the back-up rolls for the cold rolling mill and the temper mill are prepared.



Source: [89, EUROFER, TG Cold Rolling 1998]

Figure 3.1: Typical configurations of cold rolled strip mills

For electrical steel sheet production, the mill design is similar to those described above. The rolling mill usually comprises a four-high reversing mill stand, which is enlarged to rolling and alternative skin pass rolling operation (rough pass up to 7 % deformation).

For higher silicon contents, flash butt welding of the head and tail of the coils to an endless strip has to be replaced by ‘agraphing’ the ends of the coils.

Technical trends and developments in cold rolled strip production, driven by increasing market demands and competition from alternative materials, aim at increasing the efficiency and the output of plants by minimising the processing time and the consumption of materials and energy. Simultaneously, the environmental impacts of the facilities are reduced. Figure 3.2 shows as an example of a coupled pickling and rolling line and a modified plant concept which shortens the process time for annealing and the following operations from 3–7 days (2–3 days when hydrogen is used) with batch annealing to approximately 10 minutes with a continuous annealing and processing line (CAPL). [89, EUROFER, TG Cold Rolling 1998], [90, VDMA 1999]

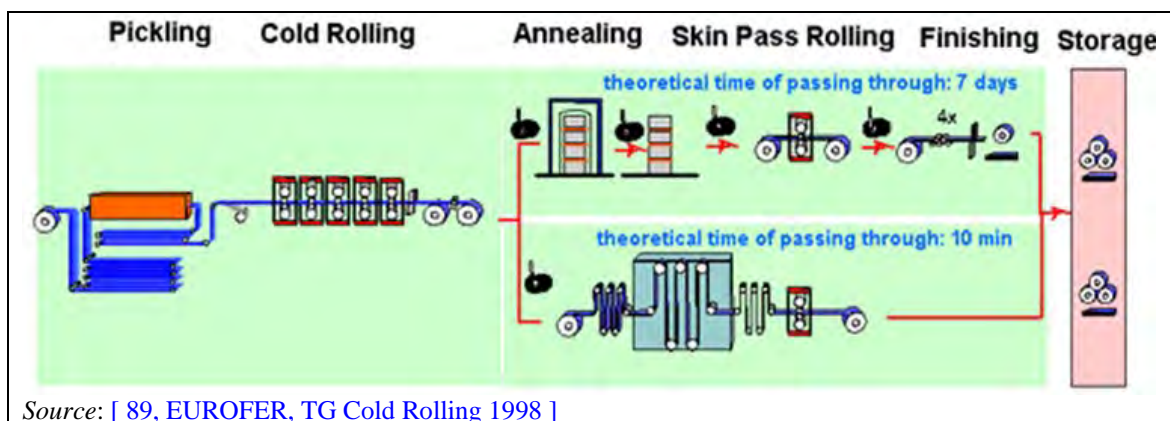


Figure 3.2: Coupled pickling and cold rolling process line with conventional batch processing vs continuous annealing and processing

3.2.2 Pickling of low-alloy and alloy HR steel

The entire surface of the hot rolled coil is covered with a thin layer of scale containing oxides, which must be removed prior to cold rolling. This is done by pickling with hydrochloric acid or sulphuric acid, at temperatures typically ranging from 75 °C to 95 °C.

Once the strip or sheet is pickled, it must be thoroughly rinsed with demineralised (or equivalent quality) water and subsequently dried. Oiling is done either with rolling oil or anti-corrosive oil. [89, EUROFER, TG Cold Rolling 1998]

Pickling lines

Pickling can be done as a batch (usually for bars, rods or tubes), semi-batch or continuous process and can also involve a number of stages using several acid baths. The following process description refers to continuous pickling lines on which steel is pickled in a coiled shape. Each of the pickling steps described below can also be performed as an individual batch process.

A typical pickling plant may incorporate the following:

- Anticoil break equipment on the decoiler to avoid the occurrence of flow lines (Lüders' lines) on the entering hot rolled coil.
- Welding of the hot rolled coils to continuous strip to ensure defined constant pickling times.
- Straightening equipment prior to the entry of the hot rolled strip into the pickling tanks. The flatness of the hot rolled strip is increased by straightening, and the capacity for pickling is improved by the scale breaking effect of straightening.
- Chemical pickling zone; deep tank or shallow tank (turbulent) pickling equipment.

- Rinsing zones to remove the remaining acid on the strip surface.
- Trimming of the strip to obtain cut edges and exact widths.
- Inspection of the strip for dimensional tolerances, surface defects and residues.
- Oiling of the strip (this may not be required in a combined pickling and rolling line).

The pickling is carried out in totally enclosed equipment or tanks fitted with hoods. In both cases, the units are under continuous extraction to remove any fumes generated by specific abatement techniques like wet scrubbers.

Modern pickling plant design comprises pickling tanks equipped with external pumps. Instead of simply passing the steel strip continuously through an acid bath, the acid is pumped via a circulation system through nozzles mounted in the bath itself. The turbulence resulting from this promotes the pickling reactions. [89, EUROFER, TG Cold Rolling 1998]

Large continuous pickling lines can have capacities of up to 2.4 million t/year. Figure 3.3 shows the operational steps in continuous pickling lines. [10, Rentz et al. 1998]

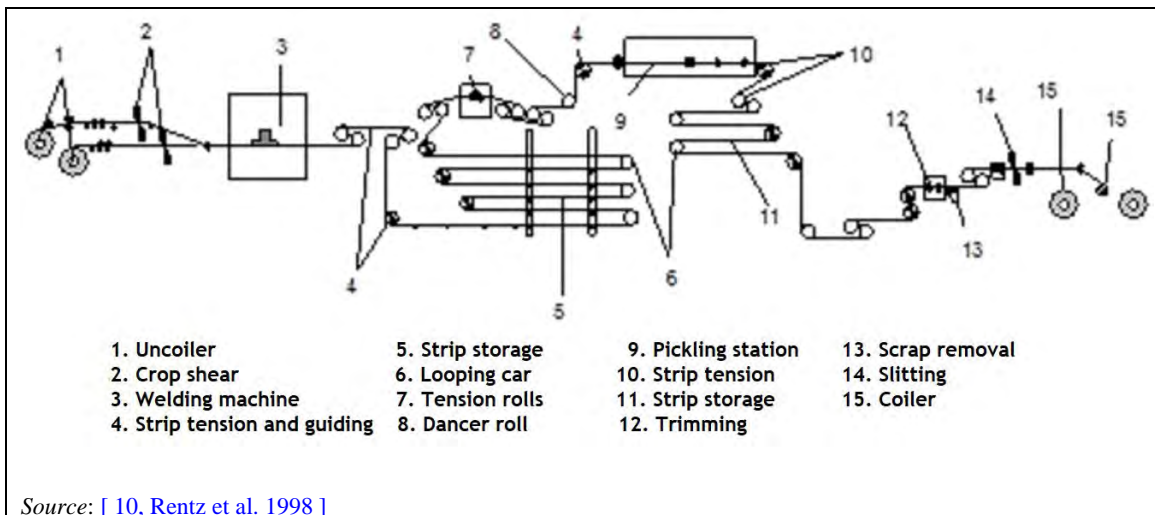


Figure 3.3: Schematic of a continuous pickling line

3.2.3 Annealing (I) and pickling (I) of high-alloy HR steel

The coils of stainless steel strip produced by hot rolling are known as 'hot band' coils. Due to the presence of an oxide scale and chromium-depleted layer formed during the hot rolling the steel must also be descaled/pickled prior to cold rolling. In addition, the greater hardness of the steel compared with carbon steels necessitates an initial annealing (I). The annealing process has three components, heating to annealing temperature, temperature equalisation and cooling. Both continuous and batch annealing processes may be used. [89, EUROFER, TG Cold Rolling 1998]

Annealing

Ferritic grades are generally annealed as tightly wound coils in a **batch heat treatment** facility. Such installations may be used for the full heating, temperature equalisation and cooling cycles. One or more coils are placed on the furnace base and covered to form a closed furnace chamber. Heating may be achieved via gas firing or electrical heating. An inert protective atmosphere (nitrogen/hydrogen) is generally required for metallurgical reasons. Ferritic steels are generally annealed at steel temperatures of up to 800 °C. [89, EUROFER, TG Cold Rolling 1998]

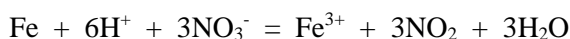
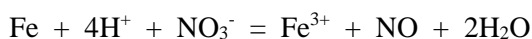
For **continuous annealing of austenitic steels**, the steel coil is unwound and passed through one or more heat treatment furnaces. These furnaces typically consist of a refractory- (or other form of insulation) lined steel structure and are usually directly fired by gaseous fuels. An oxidising atmosphere is needed to form a scale, which is rich in oxygen to allow a better pickling. The waste gases are exhausted via flues under natural or forced draught. Strip temperatures typically up to 1100 °C are necessary for annealing austenitic steels. The steel strip then passes through the cooling section and may be cooled using gas jets, air, water sprays or water quenching. Continuous annealing is generally combined with a descaling/pickling plant as described above to form a continuous annealing and pickling line. [[89, EUROFER, TG Cold Rolling 1998](#)]

Descaling and pickling

After annealing, the steel is descaled to produce a steel surface suitable for cold rolling. Mechanical descaling such as shot blasting or scale breaking may be used prior to chemical pickling to remove the heavy scale burden. However, careful control of such mechanical processes is necessary to minimise damage to the strip surface, which could affect the final product quality.

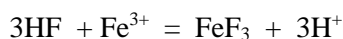
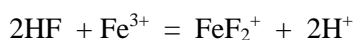
Final scale removal including the removal of the chromium-depleted layer beneath the scale is generally done by pickling in a mixture of nitric and hydrofluoric acids at temperatures of up to 70 °C. The acid concentrations employed depend on the material being processed but are normally in the range 10–18 % nitric acid and 1–5 % hydrofluoric acid.

The chemical reactions that take place during the pickling of stainless steels are complex and involve the removal of the adherent scale layer by the combined action of the acids used. The dominating chemical reaction during pickling is the dissolution of metals by the nitric acid. As a by-product of these reactions both nitrogen monoxide and nitrogen dioxide are formed. The reactions shown below are for the dominant metal iron but similar reactions also occur for the alloy elements present in the stainless steel such as nickel and chromium.



The NO_x generated is partially soluble in the acid but once the limit of solubility is reached the NO_x fumes transfer to the gaseous phase and are released from the pickling tanks. The rate of formation of NO_x increases with increasing temperature.

The metal ions formed in the dissolution reactions then react with the hydrofluoric acid, leading to the formation of metal complexes.



The combination of these two sets of reactions results in the consumption of both nitric and hydrofluoric acids. To maintain the optimum conditions for descaling, regular additions of fresh acid are made as required. The iron fluoride complexes produced in the dissolution reactions have a limited solubility and if the concentration of iron is allowed to reach 5 % (40 g/l) then precipitation of iron fluoride will commence. This precipitation causes the formation of large quantities of a hard crystalline sludge.

The pickling line design is usually the same as for pickling of low-alloy steels, except that, on exiting the last pickling tank, the steel strip is rinsed with water to remove traces of acid, then dried. Oil is not applied to the strip because of the corrosion resistance of the stainless steel. [[89, EUROFER, TG Cold Rolling 1998](#)]

3.2.4 Cold rolling of the pickled hot rolled strip

3.2.4.1 Low-alloy and alloy steel

In cold rolling, the pickled hot rolled bars, sheets or strips are passed through sets of rolls in reversing mills or in continuous in-line mills. Low-carbon steels, which are less hard, are generally rolled in multi-stand tandem mills due to the higher capacity of these mills. They consist of a series of four- or six-high stands (see Figure 3.4 and Figure 3.5). The strip enters the first stand and undergoes an initial thickness reduction; further reductions are achieved in each subsequent stand until the final gauge is attained.

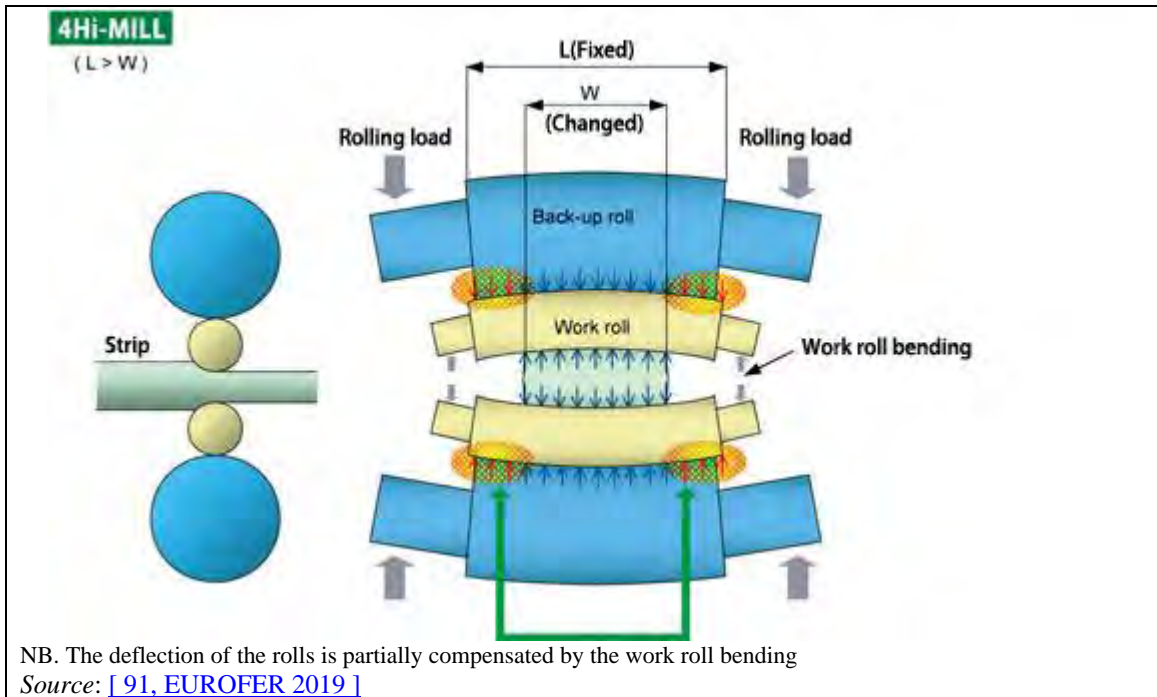


Figure 3.4: 4-high stand in a cold rolling mill

For low-carbon strip, generally an emulsion of 0.5–4 % (10–20 % for direct application) of oil in water is necessary for:

- lubrication;
- cooling of the strip, work and back-up rolls;
- removal of Fe particles.

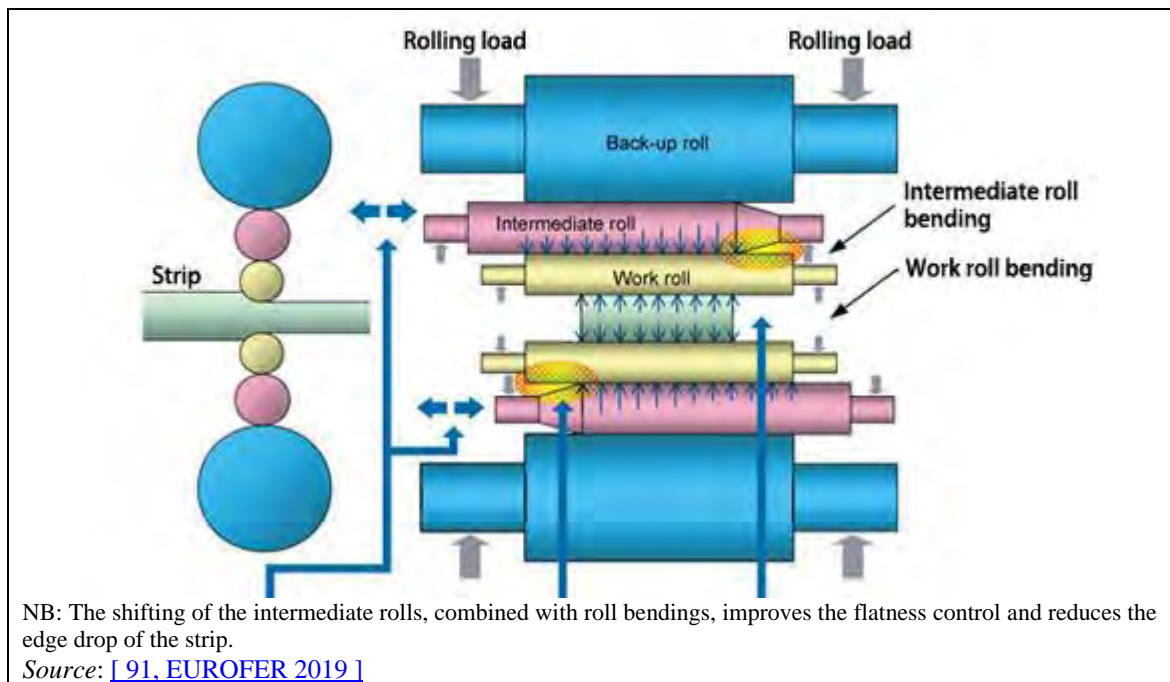


Figure 3.5: 6-high stand in a cold rolling mill

In the rolling process, the wide strip is mainly deformed in a longitudinal direction, with transverse deformation being practically negligible. The thickness reduction of the material is obtained by the influence of the rolling forces and the strip tensions (forward and back) applied. The cold forming process leads to a corresponding hardening of the material. Exact mass flow control (control of rolling force and/or position), assisted by laser control of the strip speed and tension, may be used. Thickness gauge measurement and process control are in place to ensure tight tolerances throughout the strip length. Additional automatic control loops for flatness (roll bending, zone cooling, etc.) are used to obtain the required flatness of the strip. The roughness texture of the strip surface is applied in the last stand of the tandem mill.

For optimum strip surface cleanliness, it is important to avoid contamination of the tandem emulsion by the hydraulic oil, by the Morgoil oil, by grease or by the cooling water (used to cool the emulsion). Precautions taken to avoid any contamination may include:

- continuous monitoring of oil levels;
- monitoring of the oil concentration;
- regular control of hydraulic equipment and bearings;
- monitoring of emulsion parameters such as temperature, pH value, saponification index, acid value, conductivity;
- filtering of the tandem emulsion (using techniques such as magnetic filters, paper filters, precoat filters).

To clean the strip and remove any remaining soap or oil, it may be subjected to chemical and/or electrochemical degreasing. For this purpose, cleaning zones are installed at the entry side of the downstream processing plants such as hot dip galvanising plants or continuous annealing plants. [89, EUROFER, TG Cold Rolling 1998]

Conventional discontinuous rolling

The pickled hot rolled strip is fed into the cold rolling mill coil by coil. This results in a variation in the strip thickness corresponding to the geometrical conditions of the line at the strip ends during threading and at the exit of the coil end.

To produce 'mill clean sheet', often a thin emulsion with a maximum concentration of 1 % can be used on the last stands of the tandem mill. The emulsion is usually applied via spray nozzles onto the rolls and the strip. Sometimes, higher concentrations are used in direct application systems.

Discontinuous rolling offers a high degree of process flexibility to account for variations in product mix. The technique is preferable for certain steel qualities. [[89, EUROFER, TG Cold Rolling 1998](#)]

Continuous rolling and coupled pickling and rolling

In a continuous rolling process, a continuous pickling line is followed separately by a continuous tandem mill. In this case, at the entry of the continuous tandem mill, there is a welding machine followed by an accumulator. The use of a welding machine and an accumulator allows joining coils and the strip to be fed to the mill continuously.

To achieve the narrowest possible thickness tolerances, maximum output and optimum productivity figures, a shallow-tank turbulence-pickling plant can be coupled with a tandem mill, which is enlarged by one stand. In this case, the welding machine is at the entry of the coupled line, followed by the accumulator, then the pickling line and finally the tandem mill. Usually, a welding machine and an accumulator before a tandem have the same good results and an increased capacity.

On a tandem line, the entering pickled hot rolled strip is reduced to the desired final thickness on a single pass through the line. Owing to the installation of several separate emulsion systems, a special emulsion can be applied in the last stand to increase the cleaning effect. For this purpose, either a detergent or a thin emulsion (1 % oil content) can be used.

Continuous rolling can allow good control of the strip thickness for coil ends and of surface quality. This can have a beneficial effect on material yield. In addition, it allows oil consumption to be optimised. [[89, EUROFER, TG Cold Rolling 1998](#)]

3.2.4.2 High-alloy steel

After the initial annealing and pickling, the steel is generally rolled to the required thickness on reversing cluster mills for a number of passes until the desired dimensions are achieved or until work hardening necessitates further annealing. A reverse cluster mill is composed of a multi-roll arrangement. The most usual is the 20-roll design (See Figure 3.6). In this case, the diameter of work rolls is around 50-90 mm, which reduces the roll force and torque. Intermediate rolls ensure the steadiness of the work rolls. The eight back-up rolls are composed of independent slices adjustable by excentrics, for an efficient flatness control.

The process of cold reduction generates heat, part of which is transferred to the rolling oil which is sprayed onto the steel and rolls for cooling as well as lubrication. Pure oil is used for lubrication and cooling. This heat is subsequently dissipated through heat exchangers to cooling water systems.

Mineral oils are generally used as rolling oil and close control of the oil cleanliness is necessary for optimum performance. This may be achieved using oil filtration circuits, which incorporate media element filters or powder precoat filter systems. Although the use of mineral oils predominates, emulsion cooling systems similar to those used for carbon steels may be employed. In such cases additional precautions must be taken to control oil cleanliness in order to avoid strip marking.

Collection hoods are fitted to the mill and operate under continuous extraction to remove the oil mist that is generated. [[89, EUROFER, TG Cold Rolling 1998](#)]

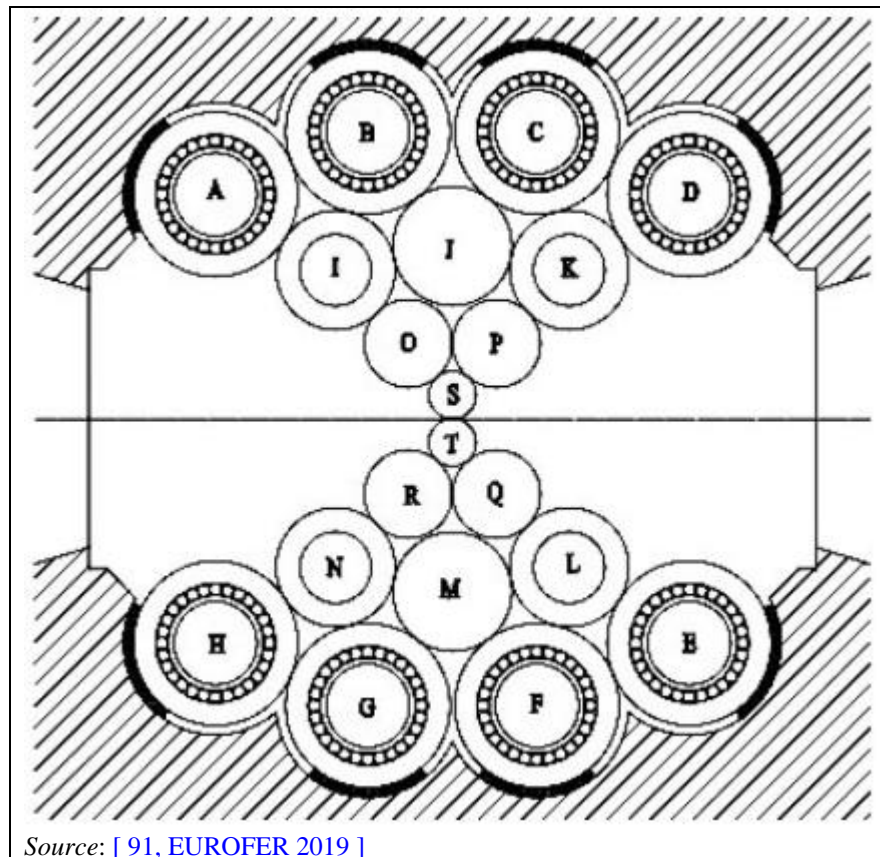


Figure 3.6: Typical 20-roll mill for stainless steel rolling

3.2.5 Annealing of low-alloy and alloy steel

The basic stages of the annealing process comprise:

- heating to annealing temperature (above 650 °C);
- holding at annealing temperature;
- cooling.

This annealing process may be carried out in batch furnaces or continuous furnaces. The annealing cycle has a significant influence on the mechanical properties and, consequently, on the formability of the steel strip. The main parameter controlling the annealing cycle is the temperature profile. It varies depending on whether the annealing is carried out in a continuous or batch furnace and depending on the required strength or hardness of the product. The annealing cycle depends on a number of parameters including the actual material analysis, the reduction realised during cold rolling, the required mechanical properties and the required surface cleanliness, the type of protective gas, etc.

Continuous annealing and batch annealing are considered to be complementary processes and not fully interchangeable. Production-related issues are integral to the selection of the annealing technique.

3.2.5.1 Batch annealing

Degreasing/Cleaning by means of alkali

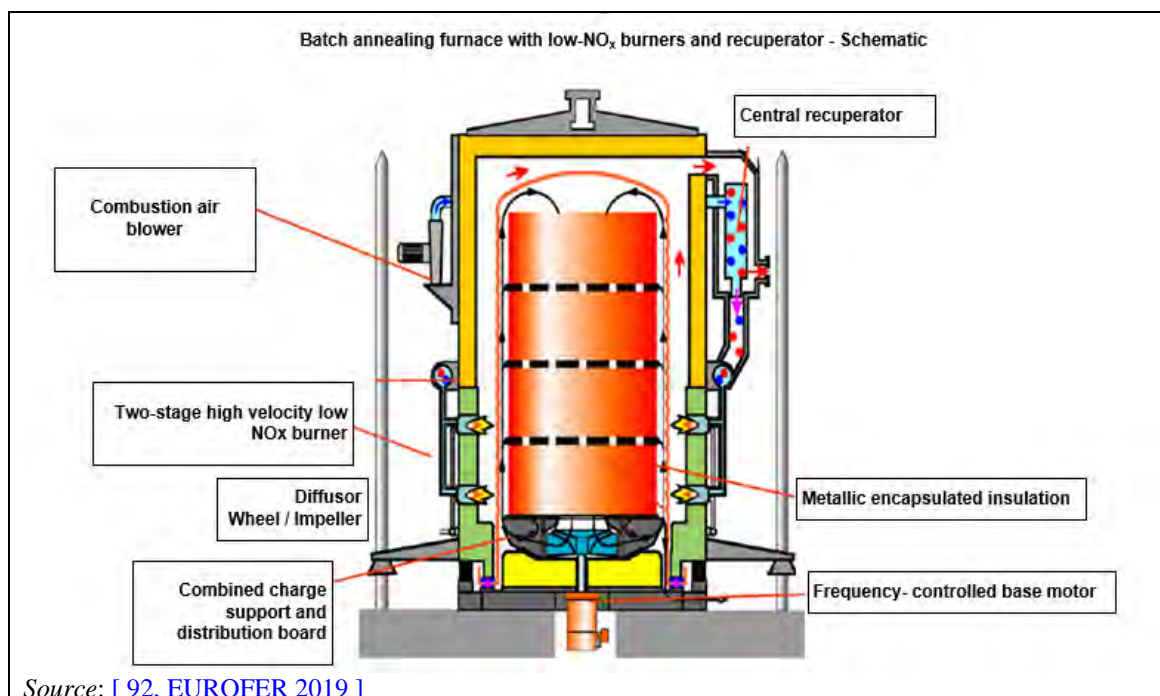
Prior to the annealing process, the strip may be cleaned (degreased) to produce a cleaner surface (normally for packaging steel). The cleaning serves to remove oil residues from the steel

surface. The process is similar to that used for acid pickling except for the chemicals that are used. The most frequently used cleaning agents are phosphates, alkaline silicates, caustic soda and soda ash. Electrolytic cleaning and brushes are also used in some cases to remove iron fines from the strip surface.

The steel sheet is unwound from the coil and passed through cleaning tanks, which may be stirred to improve the cleaning effect. Subsequently, the steel is rinsed with water and recoiled. The degreasing solution can be regenerated and recycled.

Annealing

The cold rolled coiled strip is stacked in a hood-type furnace for annealing (see Figure 3.7). The combustion chamber (space between heating and protecting hood) is heated by oil or gas burners. Heat passes through the protecting hood into where the steel coils are stacked. A circulating fan provides a temperature distribution as uniform as possible. The atmosphere under the protecting hood is mostly 100 % H₂ in high convection furnaces. The atmosphere can also be HN_x gas (a nitrogen-hydrogen mixture with a hydrogen content close to the flammability limit around 5 % H₂).



Source: [92, EUROFER 2019]

Figure 3.7: Schematic of a hood-type annealing furnace

The heat passes into the coils through their outer edges, so that these areas are always hotter than the inner windings, especially during heating up. The heat treatment causes the organic residues of the emulsion to partly burn off; a partial distillation process takes place. Products of the reactions taking place are CO/CO₂, H₂, FeO_x and CH₄. The strip is heated to recrystallisation temperature, and annealed at about 610-700 °C, resulting in complete recrystallisation of the cold rolled steel. For cooling the coils, the heating hood is removed. The cooling effect can be enhanced by spraying water on the protecting hood, by covering it with a cooling bell and blowing air on it or by using a cooling bypass system which cools the protective atmosphere under the protecting hood. The time necessary for annealing depends on the annealing temperature and the weight of the charge, as well as the protective atmosphere and can take 1 to 2 days (in the case of 100% hydrogen atmosphere).

The annealing process in a 100 % hydrogen atmosphere requires shorter annealing times (heating up and cooling down phases are much faster), the strip surface gets cleaner and the specific energy consumption is much lower than in a HN_x atmosphere. [92, EUROFER 2019]

In contrast to reheating or intermediate heating in hot rolling (which aims at heating the feedstock as quickly and as uniformly as possible to the rolling temperature), the annealing heat treatment aims at providing specific physical/mechanical properties to the product by heating, holding and cooling according to the product using a specific temperature profile to allow the internal grain structure to regroup (recrystallise). In continuous annealing, the required temperature profile is obtained by the strip passing through different heating/temperature zones in the furnace. In batch annealing, the temperature profile is obtained - in situ – by varying the temperature of the whole furnace over time. Figure 3.8 shows the different phases of a batch annealing cycle and the temperatures of the heating hood and specific zones in the coil. Approximately half of the batch annealing cycle is dedicated to heating while the rest of the time is for cooling. The heating phase with the heating hood ends when the hot and cold spots of the coils have the same temperature. In case of HNX atmosphere (i.e. 95 % N₂, 5 % H₂) the phases for heating and cooling are approximately 50 % to 80 % longer. [3, EUROFER 2020], [92, EUROFER 2019]

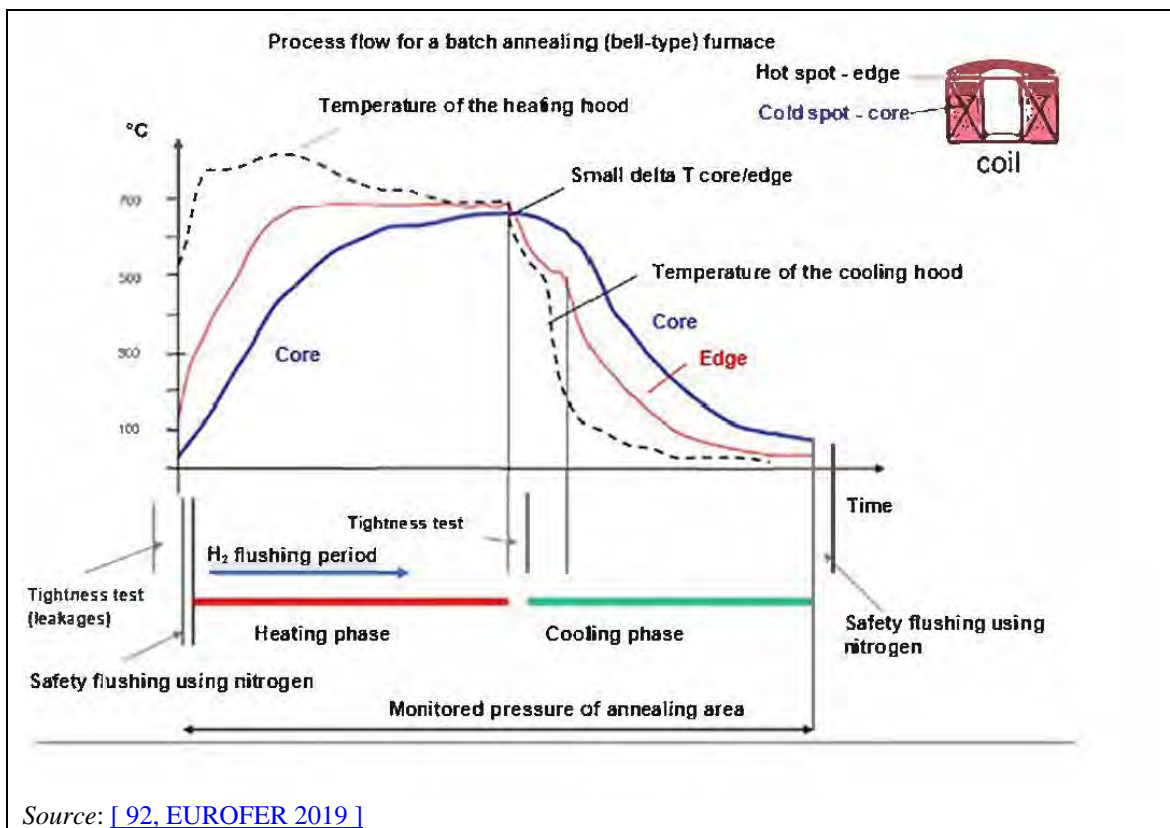


Figure 3.8: Example of temperatures during batch annealing cycle

The NO_x emissions will vary with the temperature of the heating hood of the furnace during the annealing cycle and is related to the variation of the air preheating temperature. [3, EUROFER 2020]

3.2.5.2 Continuous annealing

For continuous annealing the coils are welded together on the entry side of the plant and subjected to the following process steps:

- alkaline/electrolytic cleaning of the strips;
- heating and holding at the required annealing temperature;
- cooling (slow jet cooling, high gas jet cooling (using cooling rates up to 150 °C/s, hot water quench, overaging, roll cooling, final cooling, misting jet cooling).

The continuous annealing is carried out by passing the steel strip through a multi-zone heating furnace with a heating chamber, annealing chamber, cooling zone, tempering zone and a second cooling zone. The steel is heated to a range between 650 °C and 830 °C and then cooled by gas jets, gas-water sprays, contact rolls or water quenching, depending on the desired metallurgical properties. These furnaces are usually fired by gas (direct or indirect) or electrically heated. The steel can be protected by an inert gas atmosphere or a reducing gas atmosphere in parts of the furnace. The principle operational steps for continuous annealing are shown in Figure 3.9.

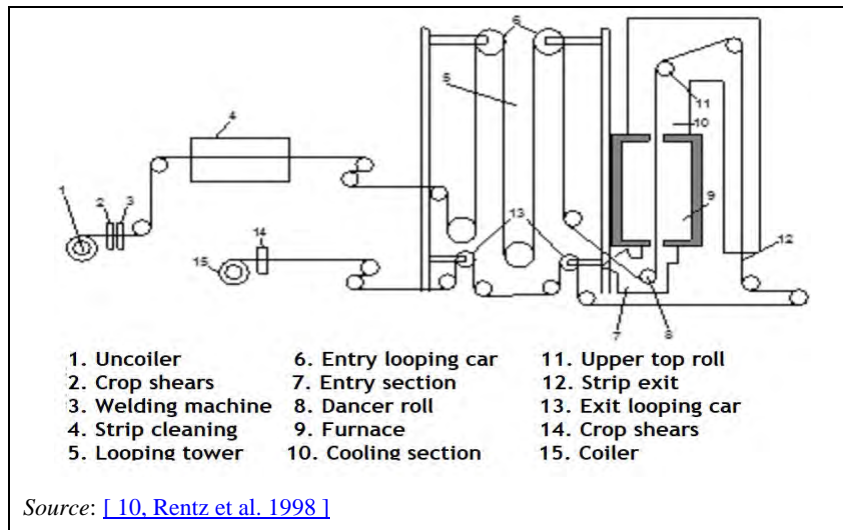


Figure 3.9: Example of a continuous annealing furnace

Continuous annealing gives a shorter processing time (about 10 minutes), less intermediate storage, uniform mechanical properties and a superior surface cleanliness. Continuous annealing is more appropriate for the production of higher-strength steels. The layout of the furnace facilitates energy recovery from the exhaust gas.

3.2.6 Annealing (II) and pickling (II) of high-alloy steel

Degreasing

Prior to the final annealing process, degreasing of the strip may be required to remove any contaminants from the steel surface. This can be achieved using an alkali-based cleaning system, which may be incorporated in the entry section of continuous annealing lines.

The steel coil is unwound and passed through a series of tanks containing the cleaning solutions. Agitation of the solution is usually incorporated to enhance the cleaning. Afterwards the strip is rinsed with water. Demineralised water can be used for the final rinsing step [89, EUROFER, TG Cold Rolling 1998]

Annealing

The process route for final annealing and pickling is dictated by the surface finish required. Examples of this are EN standard finish '2R' which requires a bright annealing treatment and surface finish '2B' which requires annealing and pickling.

Using bright annealing with hydrogen as an inert atmosphere not only increases the speed of heating because of better heat conductivity, but it also leads to a brighter surface, as indicated in the name of this process. The biggest advantage in terms of energy consumption and resource consumption is that bright annealing does not require another pickling step because the surface is already scale-free.

Bright annealing is generally conducted in an electrically heated or gas-fired furnace with a protective inert atmosphere of nitrogen and/or hydrogen. Both batch annealing and continuous annealing may be used. Degreasing of the steel surface is required to prevent surface discolouration.

Material with a '2B' surface finish is generally processed in continuous annealing and pickling lines. The furnace design and operation is generally similar to that for the annealing of hot band material described above. The steel is unwound and passed through one or more furnaces, which are usually gas-fired. Annealing takes place in an oxygen-rich atmosphere. This is necessary to ensure that the scale generated in the furnace is of a composition that is readily removable by the downstream chemical pickling processes.

Pickling

Unlike the descaling of hot band material described above, mechanical descaling techniques cannot be employed to assist in the removal of this scale due to the surface damage which would result for the final cold rolled strip. Therefore only chemical pickling is applied. This is done in the same manner as described above for hot band pickling.

Scale of high-alloy steel, due to the presence of oxides of alloying elements, cannot always be removed in just a single acid descaling step. Additional treatment or pretreatment processes may be necessary. These may include scale removal by an initial electrolytic descaling process (using for example sodium sulphate) installed prior to the mixed acid section. Generally these facilities operate with neutral salts or acids as the electrolyte. It is appropriate to consider the electrolytic process as a prepickling system as satisfactory descaling cannot be achieved with this section alone. However, the length of the mixed acid section required (and hence the acid consumption and environmental impacts) is considerably reduced. Furthermore, the combination of electrolytic and mixed acid can provide an improved surface finish. [89, EUROFER, TG Cold Rolling 1998], [93, Cold Rolling Shadow Group 2000]

3.2.7 Tempering of cold rolled strip

3.2.7.1 Low-alloy and alloy steel

After annealing, the surface finish and mechanical properties of the steel are modified in line with customer requirements. This is done by temper rolling which consists of subjecting the strip to a light rolling pass with a thickness reduction between 0.3 % and 2 %. Before tempering, the strip temperature must be less than 50 °C.

Temper rolling is carried out in the temper mill which comprises typically 1 or 2 four-high stands, although two-high or six-high stands are also possible. For tin plate production, 2 four-high stands is common. The rolls for these stands have an extremely precise surface finish in order to control the final roughness of the strip in line with the end use of the finished product. Tempering also improves strip flatness.

Two types of processes are applied depending on the end use of the strip: dry and wet temper rolling. To avoid residues from the rolling process remaining on the strip, cleaning agents (a wet temper rolling agent) may be needed during tempering. The rolls may also be brushed with mechanical polishing equipment and an associated extraction system. [89, EUROFER, TG Cold Rolling 1998]

3.2.7.2 High-alloy steel

Similar to the process route for carbon steels, temper rolling or skin pass rolling is completed in order to attain the desired surface finish on the steel. This cold rolling treatment, comprising a minimal reduction in gauge (up to 2 %), is generally performed dry without application of oil for cooling. The temper mill usually comprises a single two- or four-high stand with precision ground rolls.

3.2.8 Finishing

Finishing comprises slitting into coils of different width strip and transversal shearing to obtain sheet. Additional steps such as straightening, sampling, oiling and marking are also completed. In general, the techniques used are similar for both low-alloy and high-alloy steels; however, oiling is not required for stainless steels.

The finishing process comprises the following operations:

- dimensional control (width, thickness and length);
- inspection for surface defects and their removal;
- sampling to determine the mechanical and technological properties, the strip roughness structure and the content of residue of particles from roll wear and carbon on the strip surface (statistical sampling);
- trimming the coils to exact width;
- straightening the strips to optimum flatness;
- oiling the strips with electrostatic oiling machines or with oiling machines equipped with sprays or rolls oiling machines (anti-corrosive oils or prelubes);
- marking the finished products with coil number, production date, etc.;
- welding of different smaller coils to bigger coils.

In the finishing shops, the coil weights used for maximising productivity are cut into the coil weights ordered by the customers. Defective coil parts are eliminated or, if necessary, the material is subjected to additional treatment for removal of the defects. This can include additional annealing, tempering or straightening. [[89, EUROFER, TG Cold Rolling 1998](#)]

Strip grinding

Grinding of the steel surface may be used to generate a uniform surface quality as well as to rectify defects. The strip is usually decoiled on dedicated process lines, sprayed with oil and ground with belts of varying surface roughness. Mineral oil is generally used for this process and filtration circuits employed to separate the swarf generated during grinding. [[89, EUROFER, TG Cold Rolling 1998](#)]

Packing

The material, now in its final form, is usually packed ready for dispatch to the customer. The packaging is designed to ensure that no damage occurs either during storage or transport to the end user. Control measures also have to be taken to prevent damage from mechanical and climatic sources. In addition, the lifting and transport equipment in the production plant should also be designed and operated to minimise damage to the steel. After finishing, packing of the individual items ordered by the customers is done. The packing materials used include: steel bands, paper, plastic, wood, seaworthy packing, special packing. [[89, EUROFER, TG Cold Rolling 1998](#)]

3.2.9 Cold pilger mills

Cold pilgering is a rolling process that reduces the diameter and the wall thickness of metal tubes in one process step. The cold pilgering process is suitable for all metals. Typical materials are mild steel, stainless steel, ferritic steel, low-alloy steel, copper and copper alloys, titanium alloys, zirconium alloys, and nickel alloys. Depending on the material, the cold pilgering process typically achieves cross-section reductions of up to 90 % for copper; 80 % for stainless steel, nickel alloys, and zirconium alloys and 75 % for high-strength titanium alloys [94, Strehlau 2006]. Figure 3.10 shows a general view and a detailed schematic of a cold pilger mill machine. During the pilgering process, the tube moves forward and rotates while the ring dies move back and forth and rotate.

The rolling tools in the cold pilger process comprise a pair of ring dies and a mandrel. The mandrel is located inside the tube in a fixed position and is rotated by the mandrel thrust block. The mandrel itself is tapered in the rolling direction. The dies have matching grooves on their circumferences. A connecting rod drives the mill saddle back and forth. This action causes the ring dies to rotate. Pinions mounted on each roll shaft engage two racks that are fixed to the machine housing. This arrangement uses the oscillating motion of the mill saddle to generate the oscillating rotary motion of the ring dies. [12, SE TWG 2019], [94, Strehlau 2006]

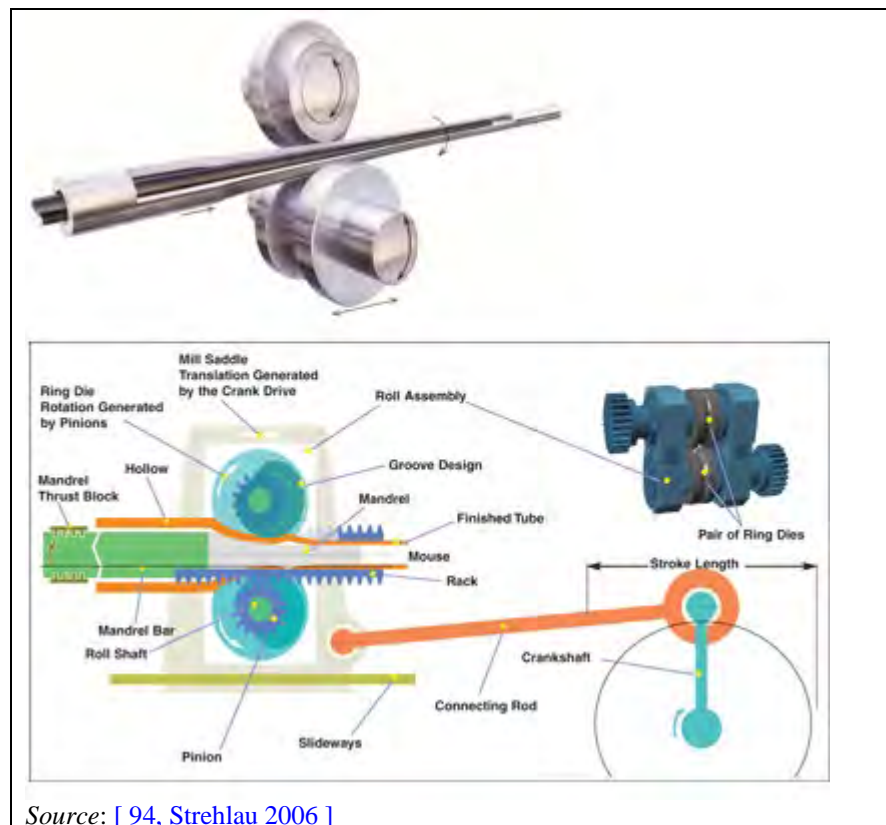


Figure 3.10: Picture and detailed schematic of a cold pilger mill

Depending on the groove design, the forming process requires more than 10 steps, feeding and rotating the tube to different positions in relation to the forming die pass. The large number of small forming steps helps to ensure a constant wall thickness and nearly homogeneous material characteristics in the rolled tube. [12, SE TWG 2019], [94, Strehlau 2006]

3.2.10 Roll shop

In a roll shop, the activities generally consist of the dismantling of the rolls, the grinding of the rolls, the texturing of the work rolls and the reassembly of the rolls.

To satisfy the required strip tolerances and surface standards, the rolls must be regularly reground. During this grinding operation, the rolls are usually cooled and lubricated with a grinding emulsion. The spent emulsion can be recirculated and filtered, but partial replacement is required periodically. In addition, used oil and grinding sludge are produced which require disposal.

The principal roll texturing systems used include the following:

- SBT (Shot Blast Texturing): This is a mechanical application of the texture onto the roll using grit blasting.
- EDT (Electrical Discharge Texturing): The work rolls are textured by spark generation in an oil bath.
- EBT (Electron Beam Texturing): In this system, the roll is placed in a vacuum chamber and the texture is applied by means of an electron beam gun.
- Laser Tex (Laser Texturing): The roll is textured to a predetermined roughness by a laser gun.
- Pretex (Premium Texturing): The roll is textured by electrolytical chromium plating which provides a uniform distribution of hard chrome hemispheres deposited on the roll surface. The chrome layer increases the roll's life and reduces the cold rolling mill's downtime. The chromium plating process is fully enclosed and fitted with an exhaust gas system using a wet scrubber. The whole process operates without an effluent discharge, because of the evaporative losses. [3, EUROFER 2020], [89, EUROFER, TG Cold Rolling 1998]

3.2.11 Water and process baths management in cold rolling mills

Water is used in cold rolling mills to clean the surface of rolling stock, for preparation of pickling and degreasing baths, for rinsing and for cooling. Pickling and related processes (rinsing, gas cleaning operations, acid regeneration) cause acidic waste water streams. In the event that degreasing is part of the processing alkaline, waste water also arises.

For cooling and lubrication, water/oil emulsions are used in the rolling sections, which gives rise to oil- and waste water streams containing suspended solids. Generally, emulsion and degreasing solutions are recycled to the process in closed loops. Water used for indirect cooling is also operated in closed loop circuits. (Classifications and definitions for water circuits are analogous to those used in hot rolling; refer to Section 2.2.17).

In cold rolling, direct application of oil is used in the case of packaging products and pure oil is used in the case of stainless steels. [3, EUROFER 2020]

3.2.11.1 Roll gap lubrication systems: emulsion or pure oil application

Emulsion systems

In the case of carbon steel production, typical cold rolling mills (4 or 6 high stands) are equipped with emulsion cycles as shown in Figure 3.11.

To maintain these loops, the circulated liquids have to be treated and conditioned by emulsion settling and cooling. Measures to maintain the quality of the emulsion and to extend the lifetime are described in Sections 3.4.2.8 and 3.4.4.3.

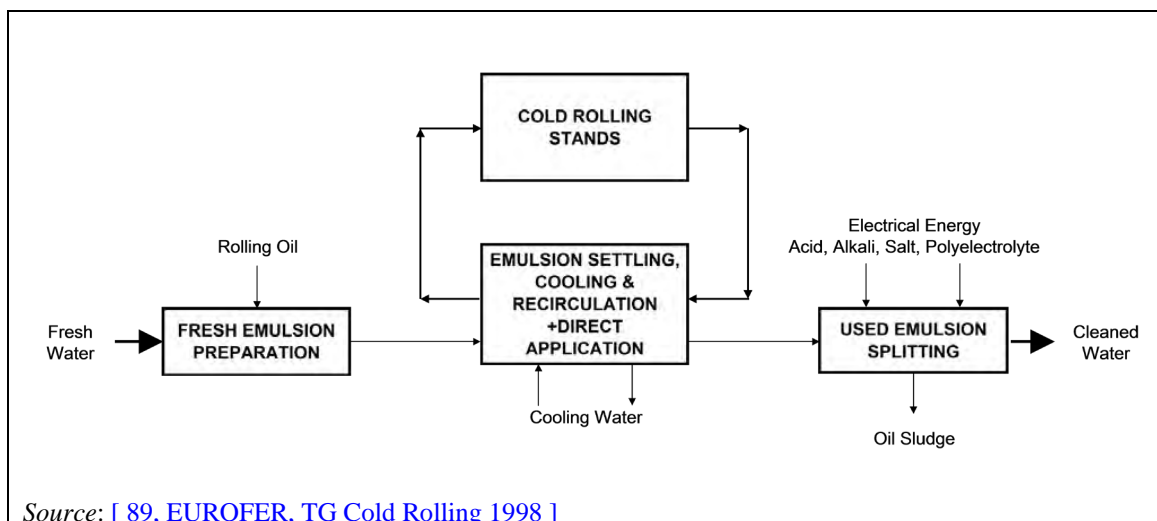


Figure 3.11: General emulsion flow

Pure oil application

In the case of stainless steel production, cold rolling is mainly performed using reversing cluster mills like Sendzimir mills or Sundwig mills where well-supported work rolls with small-diameter (e.g. < 100 mm) makes heavy reductions possible.

Beyond the fundamental role to reduce incoming band thickness down to the customer final gauge (achieved after many passes), a key objective is to produce an excellent surface finish (low roughness, high brightness, homogeneous surface). The incoming rough surface is significantly modified during cold rolling due to high friction, which result in high abrasion of the band. Due to high deformation energy (steel hardness) and high friction, the band temperature and especially the contact temperature are very high. Consequently, it is mandatory to use a lubricant and conventionally for stainless rolling, pure oil application is employed.

Continuous recirculating coolant is used to lubricate and cool the roll gap, the work and back-up rolls including their bearings, which is a key feature of cluster mills. The main cooling of the mill is done at the roll gap by using high pressure sprays. In general, the flow of the lubricant is directed from the centre towards the outside edges of the strip to wash away any loose particles of the metal being rolled. With the same oil, the unsealed support bearings are lubricated and a low-viscosity oil (< 8 centi-Stoke) with high flow rates is needed to prevent these bearings from heating up excessively and to keep foreign particles out.

Appropriate oil formulations with a base oil and some additives such as extreme pressure, anti-wear agents, oiliness agents and antioxidants are selected. For a given oil, if the contact conditions are too severe, heavy reduction combined with high speed, defects like heat streaks may occur resulting in a non-uniform surface.

The abrasion of the band is very intense and there is a large quantity of metallic particles generated. An efficient filtration of the lubricant and a good maintenance of the filters are required. The coolant system consists of a tank containing the contaminated lubricant, pumps to transfer the contaminated lubricant to filters, a clean oil tank and pumps to send back the clean lubricant to the mill. Continuous recirculation of oil is used. Within the most advanced installations, the filtration is done using cartridges made of special media, nylon in general. Typically oil is filtered below 2 μm . To extend the life of filters (e.g. up to 20 years for instance), they are often back flushed automatically with air pressure. The residues collected during this operation are removed and collected for recycling operations with specialised companies. With this kind of equipment, non-recyclable waste products such as diatomaceous earth are avoided.

For production where the glossy surface is not a major objective, mainly for thick material, lubrication can be done using recirculated oil-in-water emulsions as previously described in the case of carbon steel production emulsion systems). In this case, the principal advantage is to obtain a high cooling efficiency. More recently, multi-stand tandem mills have been proposed also with oil-in-water emulsion. However, this kind of installations, where work rolls are not

changed frequently, are not dedicated to the most demanding surface quality. [208, EUROFER 2021]

3.2.11.2 Degreasing solution system

In degreasing solution systems (see Figure 3.12) the recirculation of the solution is enabled by removing oil and other contamination, e.g. by magnetic filtering or ultrafiltration.

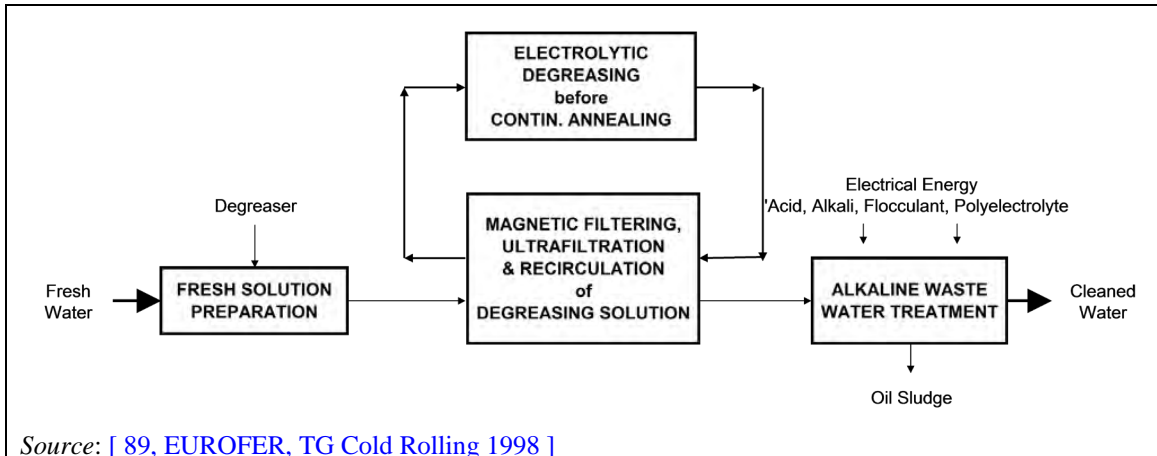


Figure 3.12: Degreasing solution flow (continuous annealing line)

3.2.11.3 Cooling water systems

In cold rolling mills, cooling water is required to dissipate excessive heat from the rolling process (rolling energy) and from the annealing furnaces (heating energy). The rolling energy is mainly dissipated via the emulsion to the emulsion cooler and partly via the lubricant and hydraulic cooler to the cooling water. The main cooling water consumers are:

- emulsion cooling for tandem line;
- skin pass mill stand installed downstream of the batch annealing plant;
- continuous annealing plant with skin pass mill stand;
- cooling of transformers and motors;
- oil lubrication facilities.

The thermally loaded cooling water is recooled with industrial water in plate heat exchangers, if adequate water supplies are available, or by evaporation in cooling towers. Recooling in heat exchangers offers the advantage that considerable amounts of chemicals for cooling water (such as corrosion inhibitors, hardness stabilisers, dispersants and biocides) can be saved and are not discharged into the sewage system. The cooling water circuits are treated with corrosion inhibitors, but discharge of a partial flow with a high salt content is not necessary with these closed circuits. For cooling tower circuits, in contrast, regular discharge of partial flows to a sewage system is required to counteract salt concentration resulting from evaporation. Due to water evaporation in cooling towers, the local climatic conditions can be affected by the constant formation of fog and by the so-called industrial snow, which may be an issue in central and northern Europe.

In principle, both the use of recooling and evaporative cooling towers are viable systems for use and the choice of system will depend on the location and other site-specific issues. In some countries, taxes are levied on abstraction and discharging water which can affect the choice of system used. [93, Cold Rolling Shadow Group 2000]

Figure 3.13, Figure 3.14 and Figure 3.15 show examples of cooling water cycles.

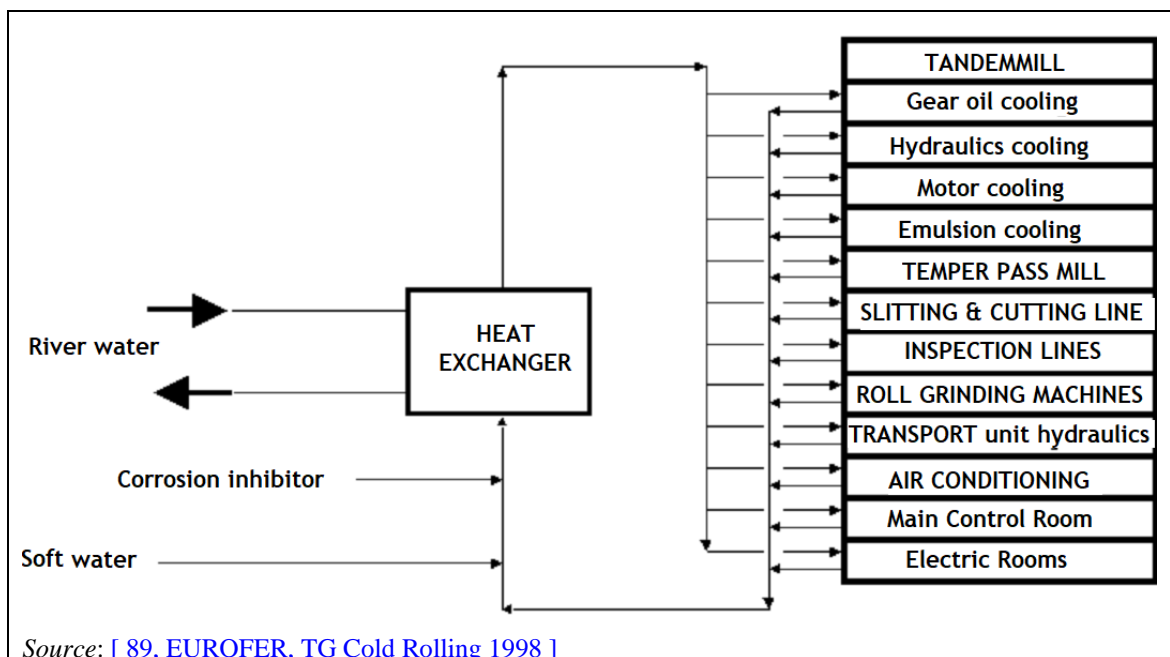


Figure 3.13: Cooling water system for a cold mill

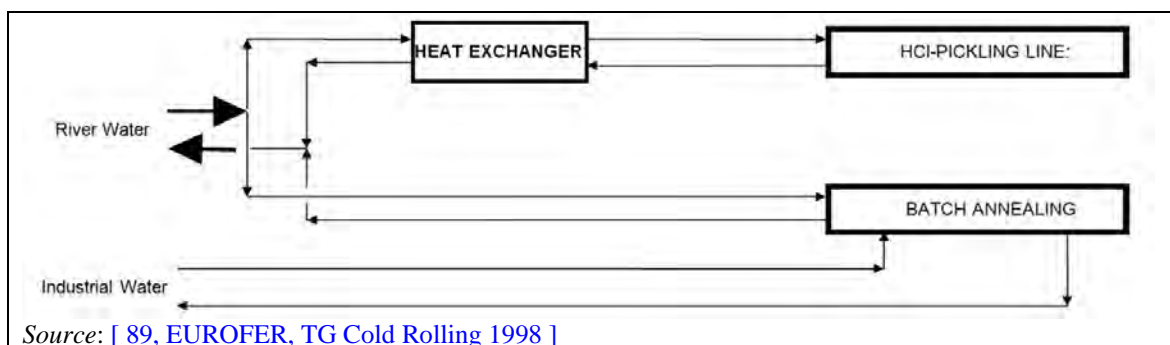


Figure 3.14: Cooling water system for HCl pickling and batch annealing

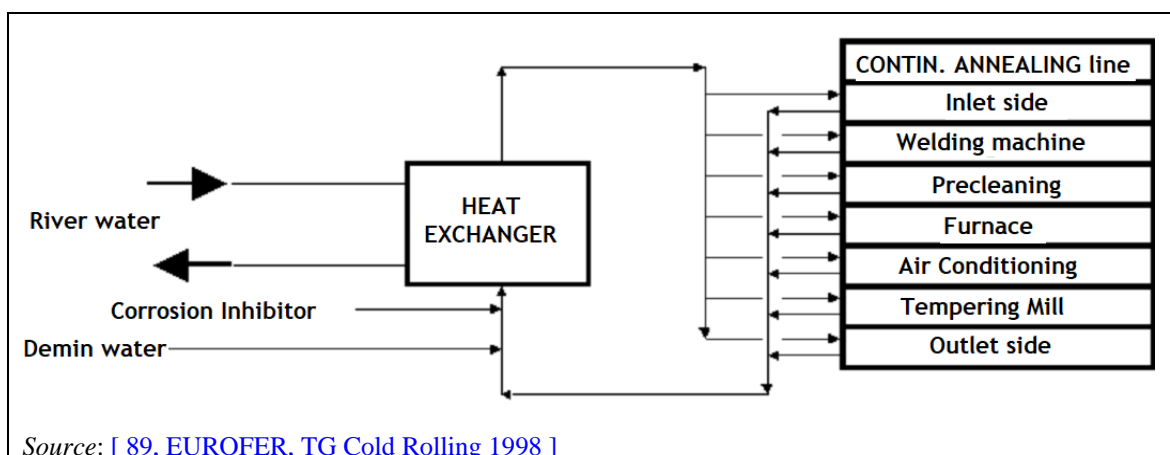


Figure 3.15: Cooling water system for a continuous annealing line

3.2.11.4 Waste water treatment

Waste water from cold rolling operations which cannot be regenerated or used elsewhere in the production line has to be treated prior to discharge.

Acidic waste water from rinsing or acid regeneration is usually treated by neutralisation with agents, such as calcium hydroxide or sodium hydroxide. The dissolved metal ions are precipitated as hydroxides and then separated by sedimentation techniques including clarification or filtration. Flocculants are sometimes used to assist the process. The sludge is dewatered, e.g. by filter presses, to reduce the final volume of sludge.

Where electrolytic chemical prepickling processes are used, additional effluent treatment steps may be required. Typically these can incorporate chromium (VI) reduction processes using sodium bisulphite or iron (II) compounds.

Alkaline waste water streams may be neutralised using HCl, filtered and then discharged.

Spent coolants/lubricants (emulsions) are treated by emulsion breaking, which is either done thermally, chemically, mechanically or physically, followed by the separation of the water and the oily phase.

3.2.12 Waste and by-product management in cold rolling mills

Cold rolling gives rise to solid residues, such as scrap (cleaning rags, cleaning paper), sludges from the waste water treatment plants, the remainder of the packing material and dust.

Scrap is recycled in the works for steel production. The **oil-containing sludges** from the waste water treatment plants may be used in blast furnaces.

Acid regeneration sludges can be recycled in steel plants (EAF and blast furnace) or given to external recycling firms for the production of iron oxides.

The **iron sulphate-heptahydrate** from the sulphuric acid regeneration plant can be used:

- for the production of complex iron-cyan salts;
- as flocculation agents in waste water treatment plants;
- for the production of gas adsorption mass;
- as a chemical amelioration agent;
- for the production of iron oxide pigments; and
- for the production of sulphuric acid. [[82, DE, TWG member 1999](#)]

The **iron oxide** from the hydrochloride acid regeneration can be used in several industries as high-quality input, e.g.:

- as input for the production of ferromagnetic materials;
- as input for the production of iron powder; or
- as input for the production of construction material, pigments, glass and ceramics. [[82, DE, TWG member 1999](#)]

Sludges from oil recovery are externally used for oil recuperation in specially dedicated plants or treated externally by incineration.

Only a small part of the **sludges from waste water treatment** is internally recycled; the vast majority is landfilled.

Oily wastes (oil, emulsion, greases) are recycled internally or treated externally by incineration.

3.3 Current consumption and emission levels for cold rolling

The following sections present the consumption and emission data reported by the CR plants across the EU that took part in the 2018 FMP data collection (in total 42 plants). The relevant plants are listed in Section 11.1 in which a list of installations/plants may be found.

Handling of Confidential Business Information (CBI)

Energy, material and water consumption data were considered CBI by the plant operators. In order to maintain data confidentiality, plant names are not directly mentioned in the graphs but are replaced by anonymised and randomly attributed CBI codes. In addition, no contextual information (e.g. process parameters or techniques applied) is included as this could reveal the identity of the plants. Only the steel category and the steel products is indicated in the figures provided that more than 5 distinct consumption values were reported in the data collection. If less than 5 distinct consumption values were reported, the data are shown under a category designated as 'other' without any indication of the steel category or the steel product to maintain confidentiality. All the consumption figures are presented in ascending order of the maximum specific energy consumption values.

3.3.1 Mass stream overview

Figure 3.16 provides an overview of the various inputs (e.g. types of steel products, energy, water, oil, acid) and outputs (e.g. cold rolled products, air and water emissions, by-products and waste, liquid wastes and sludges) in a typical cold rolling mill.

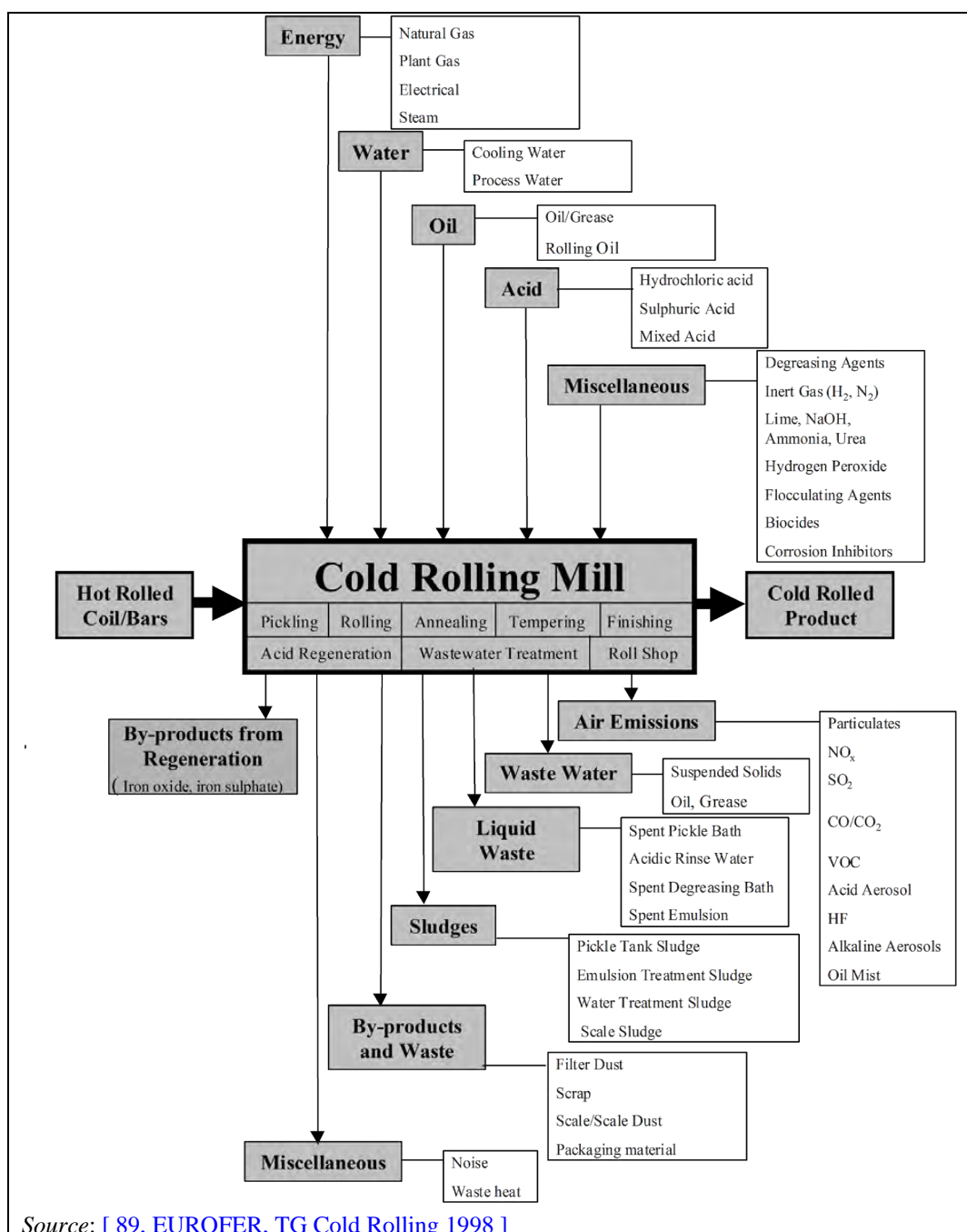


Figure 3.16: Input/output overview for cold rolling mills

3.3.2 Energy consumption

During the data collection, data on the specific energy consumption of plants (i.e. MJ of energy consumed per total amount of feedstock processed expressed in t/year) were reported for the following processes:

- rolling processes;
- annealing after rolling (batch and continuous).

Rolling processes

Table 3.3 shows the specific energy consumption ranges for rolling processes depending on the type of steel products. For rolling processes, 30 plants provided data on specific energy consumption in total. The large majority of specific energy consumption data ranged from 65 MJ/t to approximately 550 MJ/t (yearly average). Only four plants reported specific energy

consumption values higher than 1 500 MJ, as shown in Figure 3.17. Three of these plants are producing high alloy steel (e.g. austenitic) however it was not possible to specify further which ones are producing high alloy steel in order to preserve data confidentiality.

Table 3.3: Specific energy consumption ranges for rolling processes.

Steel products	Specific energy consumption MJ/t (Yearly average)
Cold rolled coils, sheets	65–412
Packaging steel	246–482
Others	127–550
<i>Source:</i> [16, FMP TWG 2018]	

Continuous and batch annealing

Figure 3.18 and Figure 3.19 show the data for the specific energy consumption of batch and continuous annealing furnaces after rolling (yearly average). A total of 16 plants reported information for the specific energy consumption with a range of 550 MJ/t to 1 700 MJ/t for batch annealing. In total, 12 plants reported information for the specific energy consumption with a range from 657 MJ/t to 1 400 MJ/t for continuous annealing.

In the production of Advanced High-Strength Steels (AHSS) or Ultra-High-Strength Steels (UHSS) in a continuous annealing line, it is necessary to heat up the strip to temperatures ranging from 850 °C up to 900 °C in comparison with the usual range of 700-750 °C for standard steel grades. This concerns a wide range of advanced steel grades such as Complex Phase, Dual Phase, TRIP (Transformation-induced plasticity), TWIP (Twinning-induced plasticity), or QP (Quenching and Partitioning-type steels). In the specific case of QP products, the strip is heated at about 900 °C. As a second step, the material has to be cooled down to around 230 °C (quenching). Afterwards, it is necessary to reheat the material a second time, up to about 500 °C, followed by a soaking step, before final cooling. The partitioning process enables carbon diffusion in the product. [95, AT 2020], [207, EUROFER 2021]

In the case of fully finished electrical steels (e.g. non-grain-oriented), high annealing temperatures of about 1 100 °C are also required in comparison to semi-finished electrical steels.

Accordingly, the production of a significant share of such steel grades in the future in the product mix of a FMP plant may lead to specific energy consumption higher than 1 200 MJ/t. [95, AT 2020], [207, EUROFER 2021]

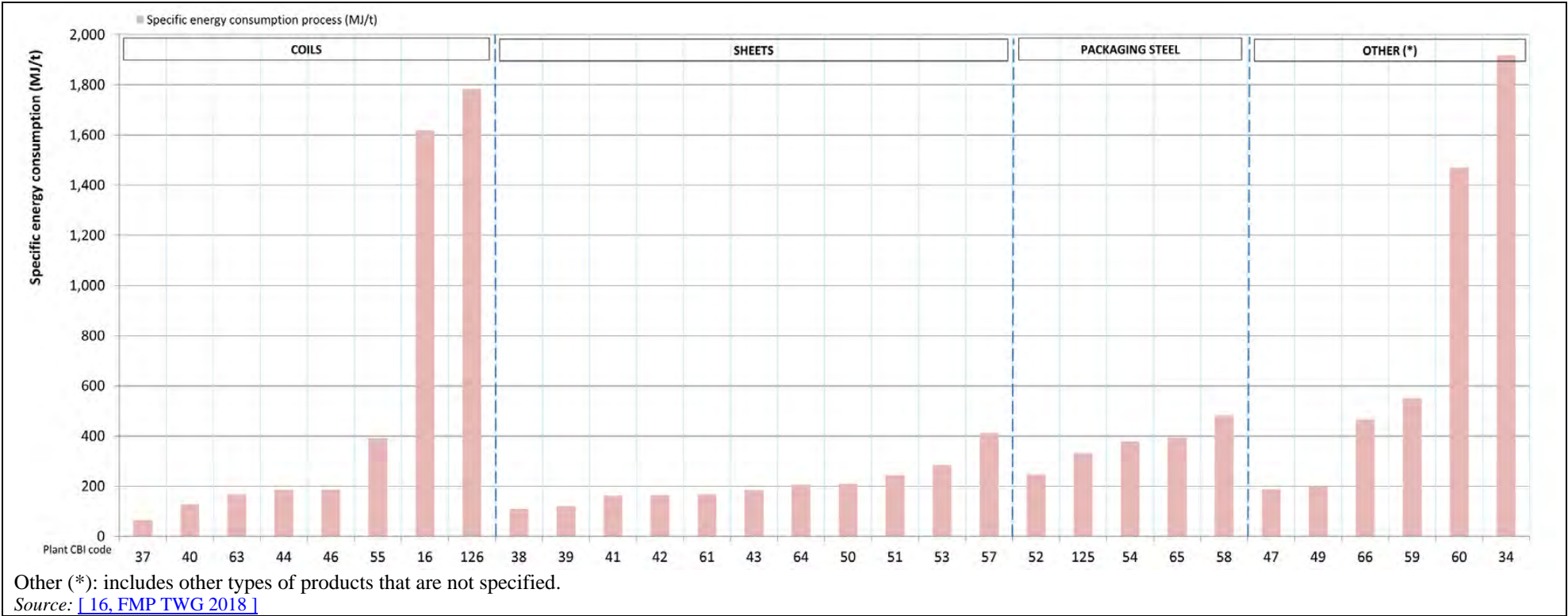


Figure 3.17: Specific energy consumption (MJ/t of feedstock processed) for rolling

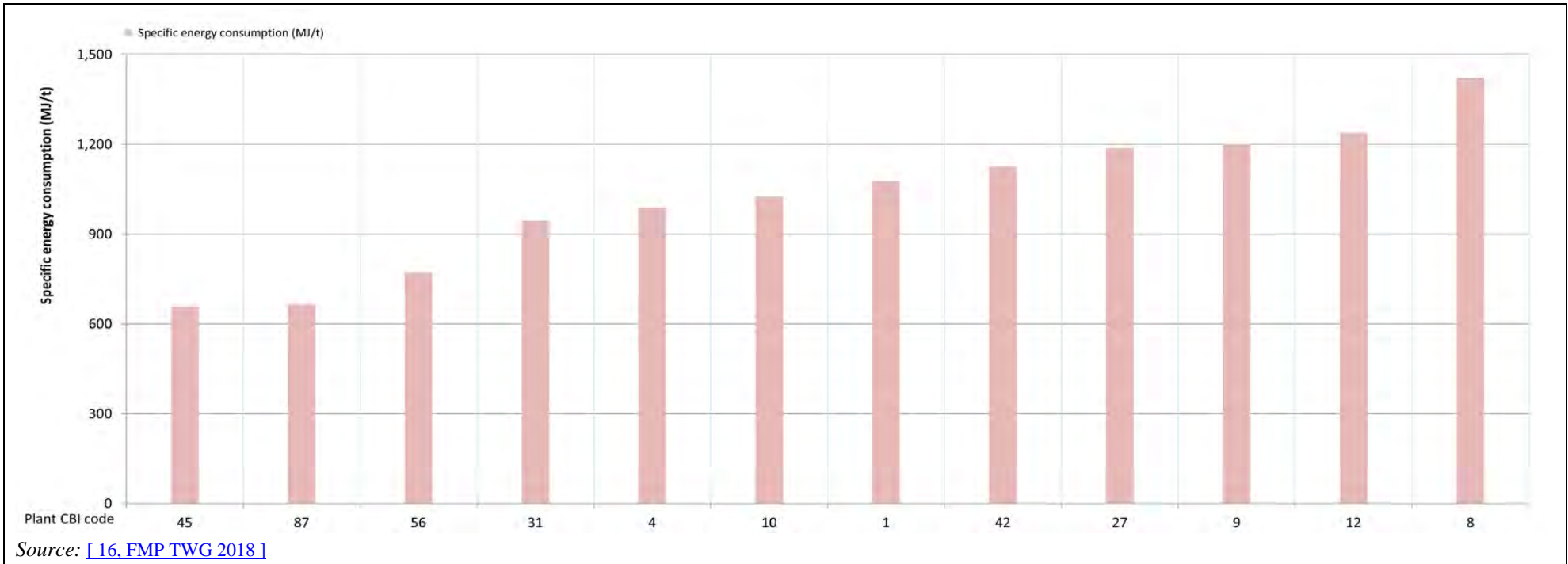


Figure 3.18: Specific energy consumption (MJ/t of feedstock processed) for continuous annealing after rolling

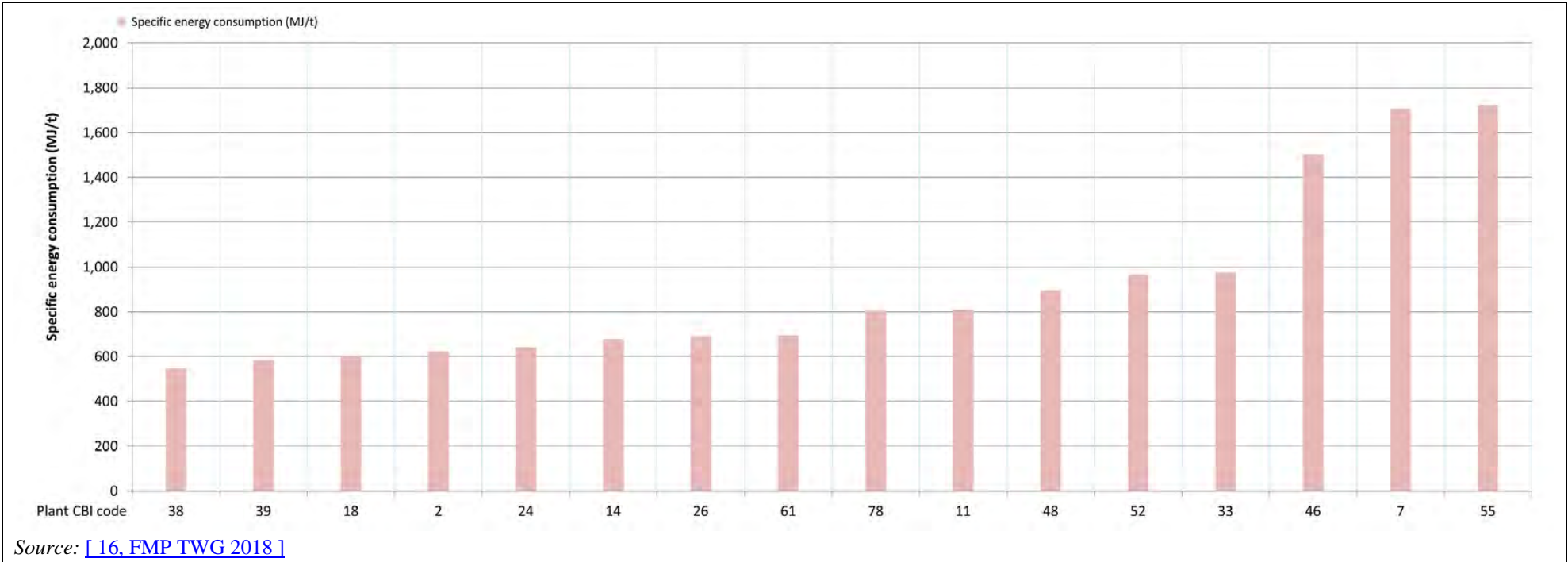


Figure 3.19: Specific energy consumption (MJ/t of feedstock processed) for batch annealing after rolling

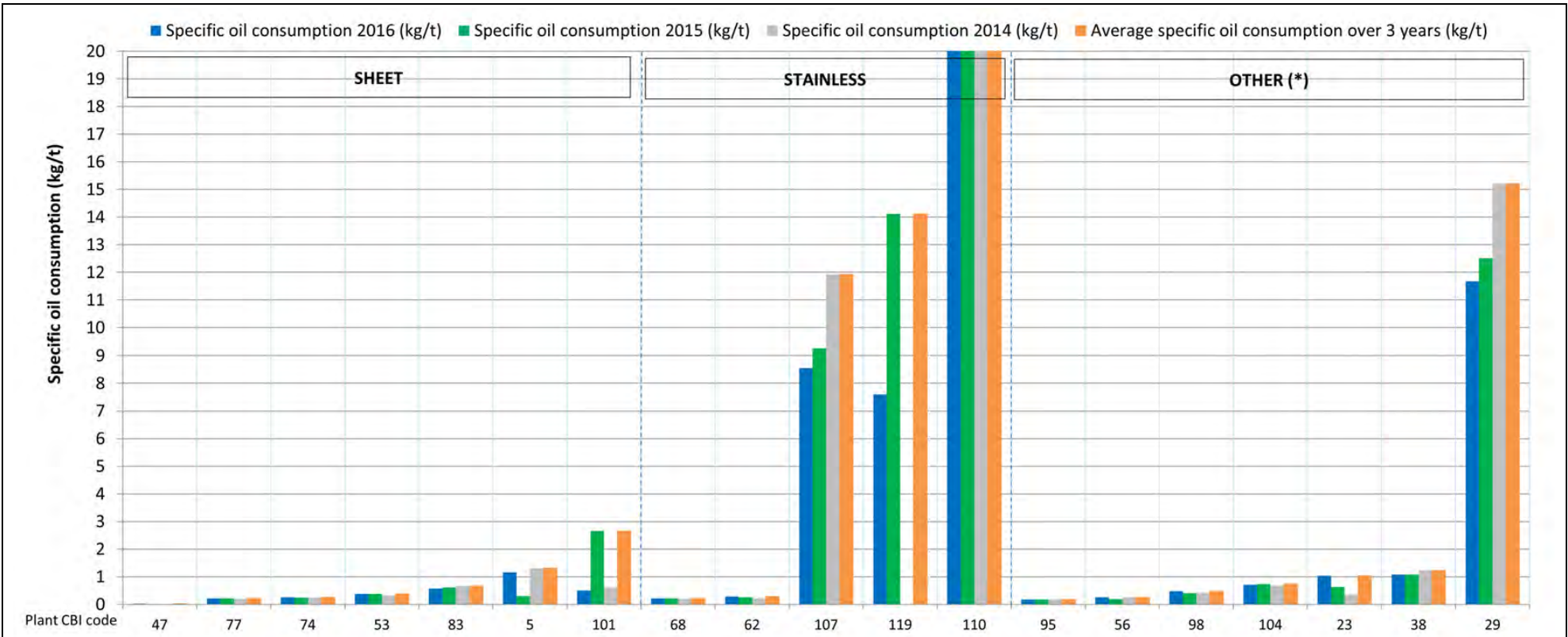
3.3.3 Material consumption

3.3.3.1 Consumption of oils

Pickling of low-alloy, alloy and high-alloy steel

Consumption of anticorrosive oil depends on the percentage of oiled products, on the type of oiling machine used (electrostatic oiling or spraying nozzles) and on the oil weight required by the customer. [[89, EUROFER, TG Cold Rolling 1998](#)]

Figure 3.20 shows the data reported concerning the specific oil consumption for three operating years and the yearly average obtained, for the cold rolling plants that took part to the FMP data collection. The specific oil consumption ranged from 2 kg/t to 15 kg/t. The values reported include all types of oils used in the plant (e.g. rolling oil, hydraulic systems oil, lubrication oil, anticorrosive oil, emulsion oil, fat and grease).



Other (*): includes other types of products that are not specified.
 Values too high or too low for the scale of the figure:

Sorting number	Specific oil consumption 2016 (kg/t)	Specific oil consumption 2015 (kg/t)	Specific oil consumption 2014 (kg/t)
110	188.70	262.08	255.46

Source: [16, FMP TWG 2018]

Figure 3.20: Specific oil consumption (kg/t of feedstock processed) in cold rolling plants

3.3.3.2 Consumption of acids

Hydrochloric, sulphuric and, for stainless steel, a mixture of nitric and hydrofluoric acid are used as pickling agents. Acid consumption varies obviously depending on whether acid is regenerated or not. It also depends on the specific surface area pickled and the thickness of the oxide layer. [89, EUROFER, TG Cold Rolling 1998]

Figure 3.21 shows the material flow for a HCl pickling line in conjunction with acid regeneration.

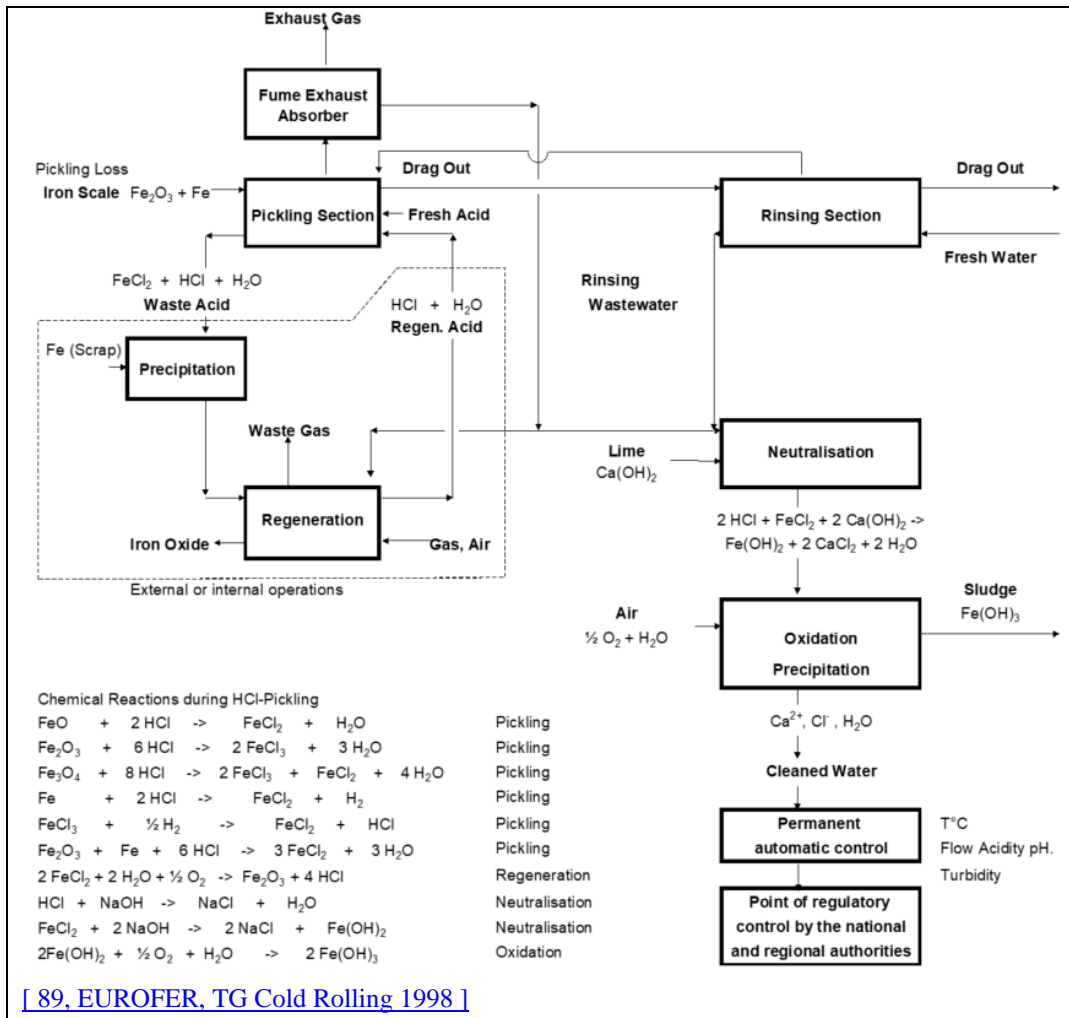


Figure 3.21: Flow sheet for HCl pickling and acid regeneration

Figure 3.22 shows the material flow for a H_2SO_4 pickling line with acid regeneration.

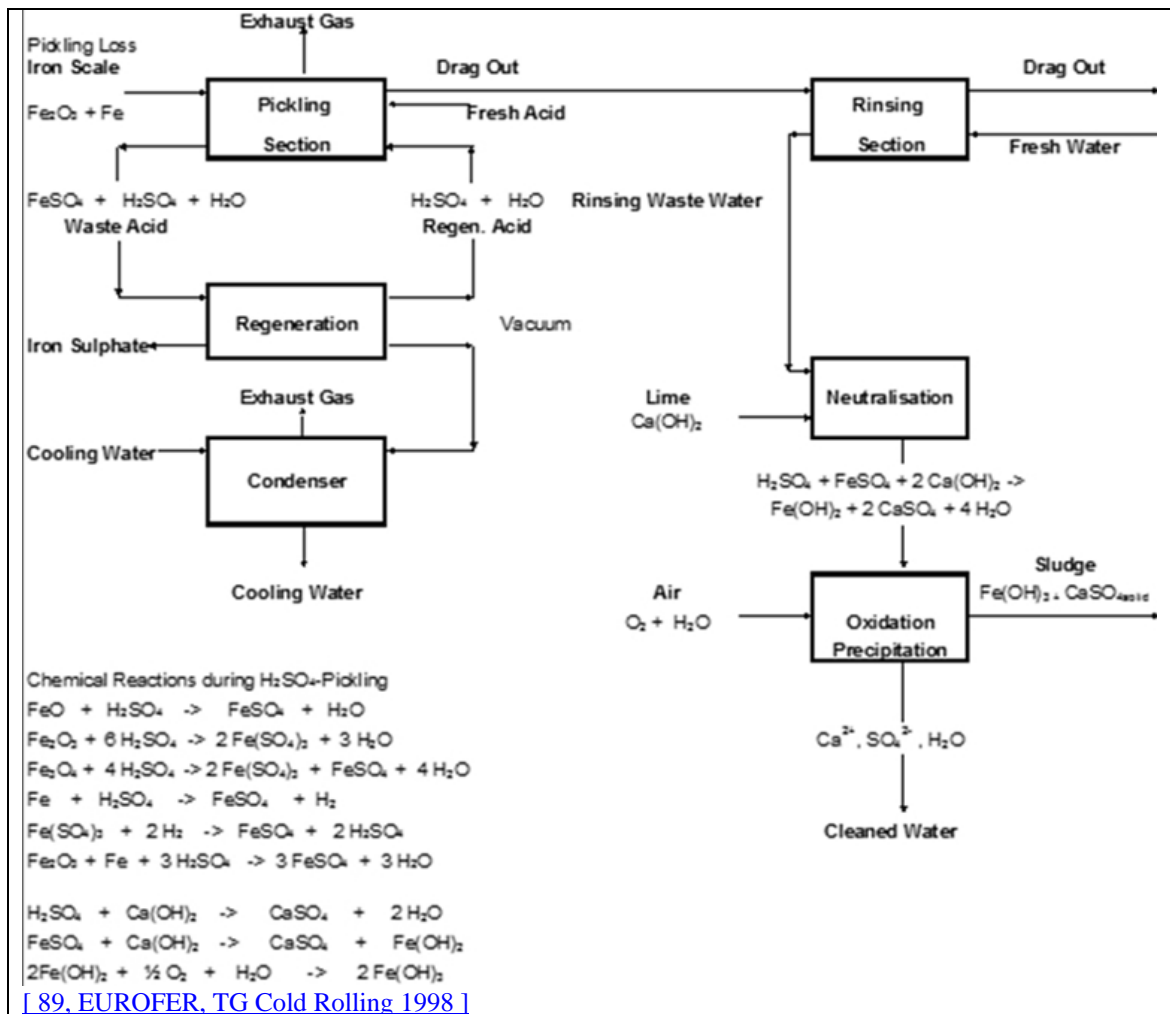
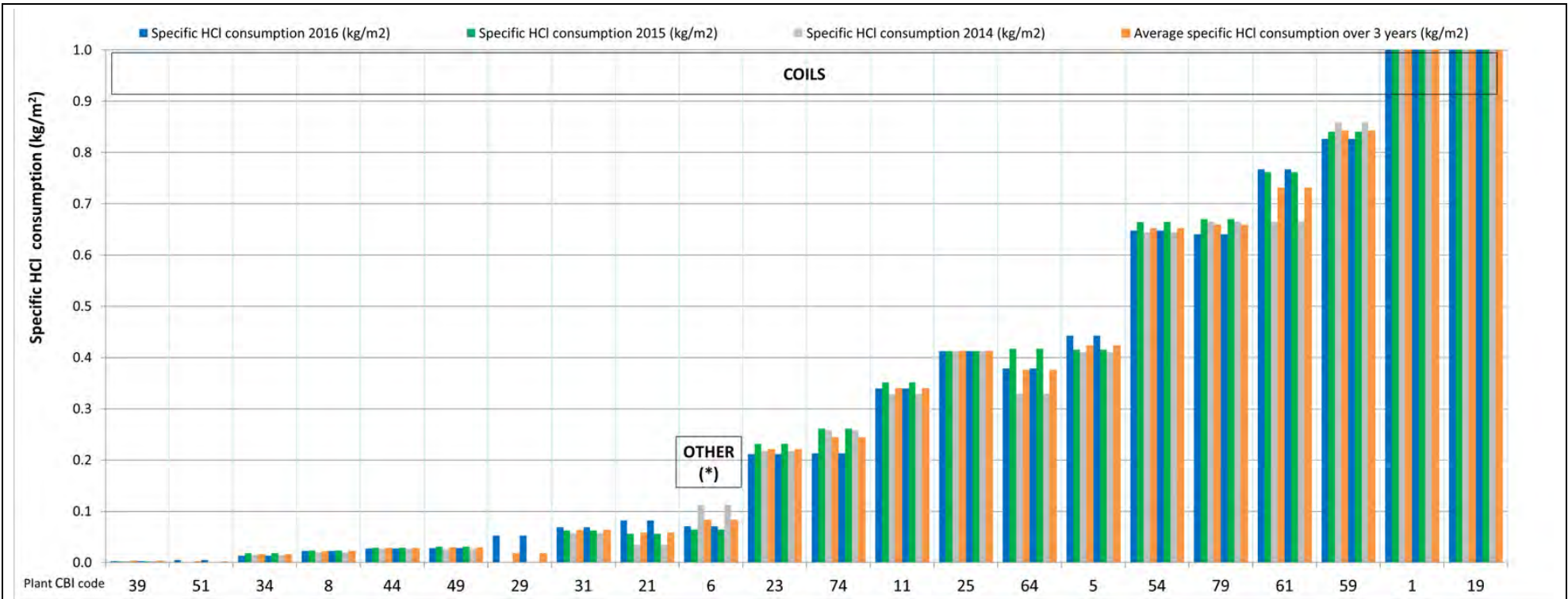


Figure 3.22: Flow sheet for H_2SO_4 pickling and regeneration



Other (*): includes other types of products that are not specified.

Values too high or too low for the scale of the figure:

Sorting number	Specific HCl consumption 2016 (kg/m ²)	Specific HCl consumption 2015 (kg/m ²)	Specific HCl consumption 2014 (kg/m ²)
1	10.29	10.29	10.29
19	545.51	475.33	512.59

Source: [16, FMP TWG 2018]

Figure 3.24: Specific HCl consumption (kg/m² of treated surface) in cold rolling plants

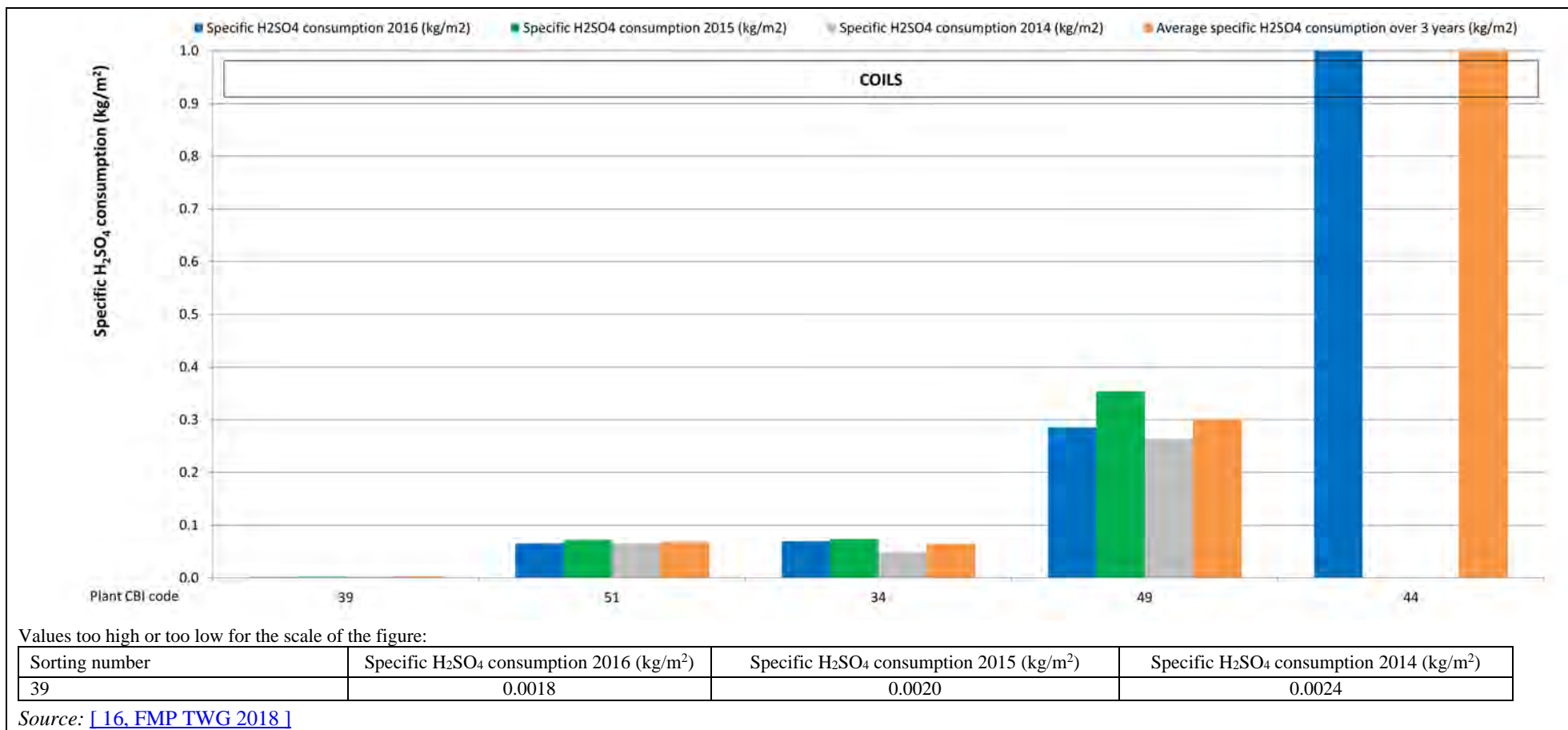


Figure 3.25: Specific H₂SO₄ consumption (kg/m² of treated surface) in cold rolling plants

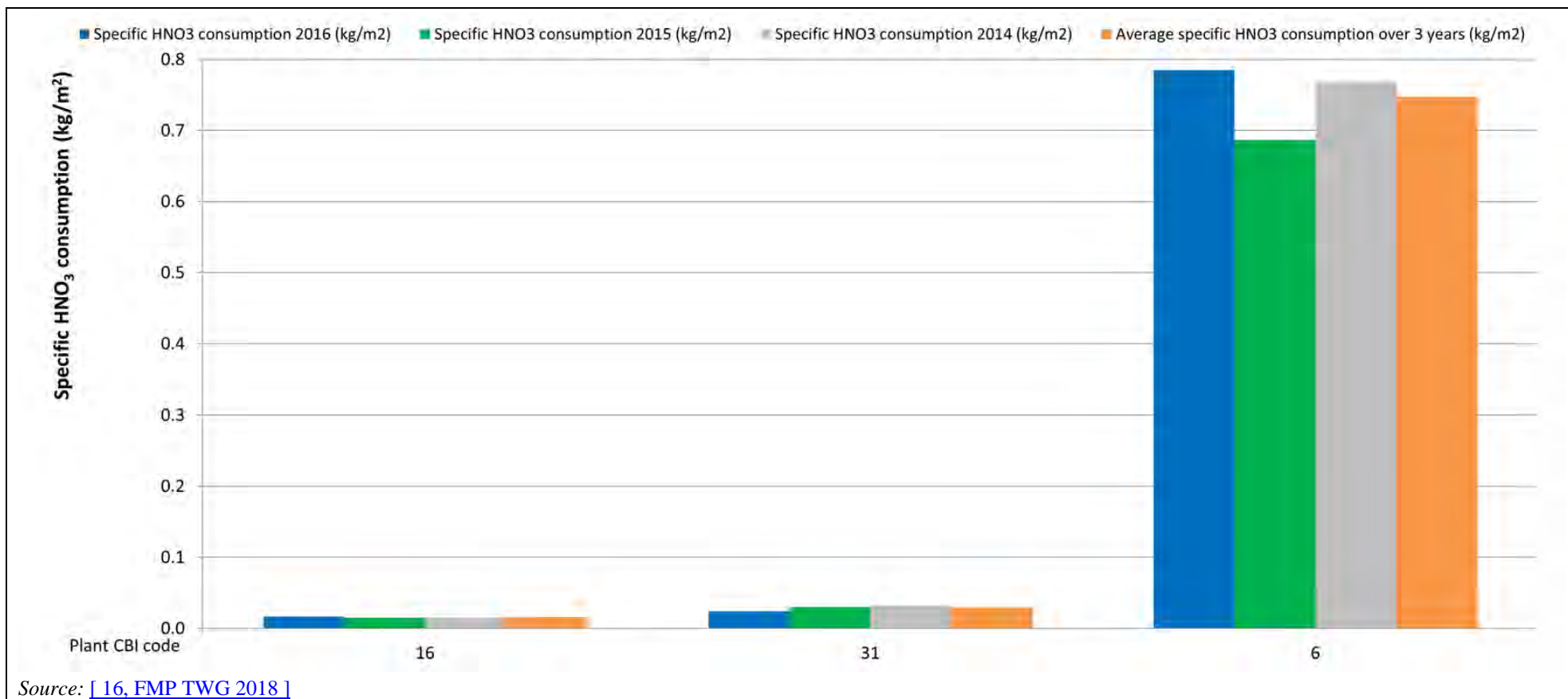


Figure 3.26: Specific HNO₃ consumption (kg/m² of treated surface) in cold rolling plants

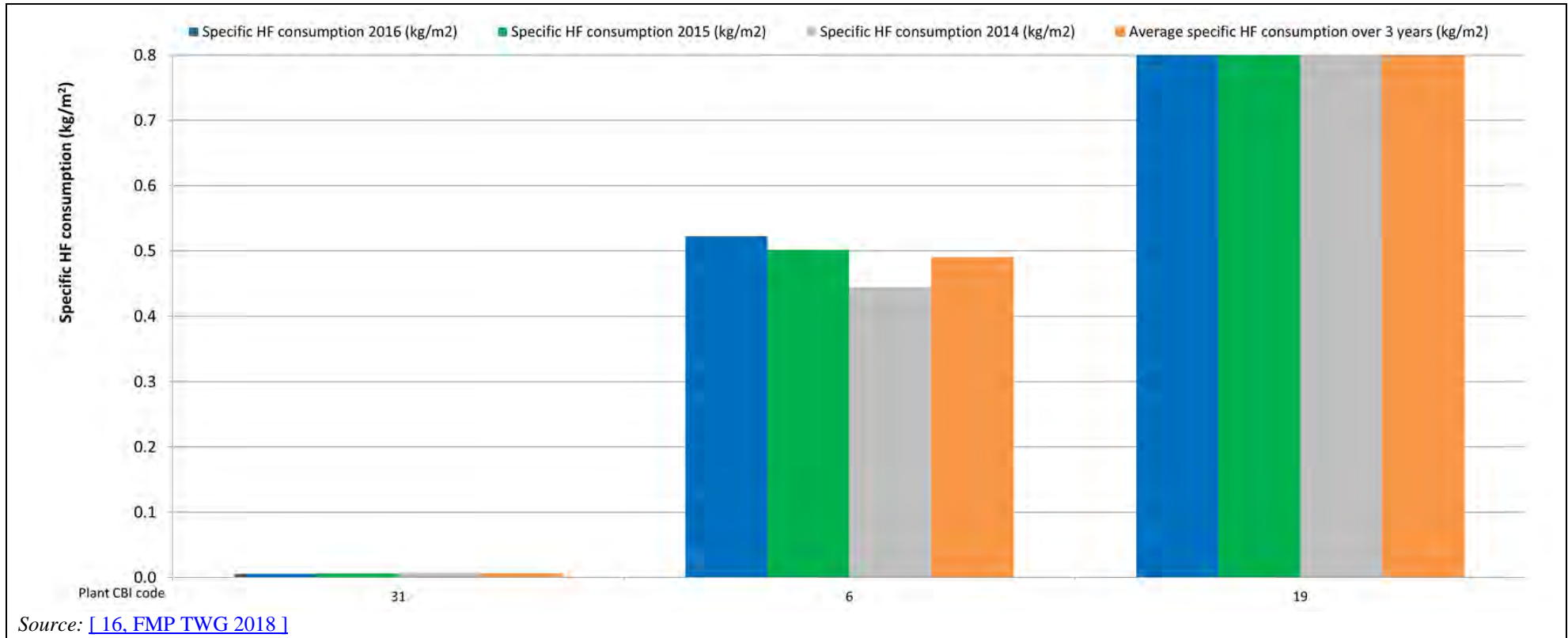
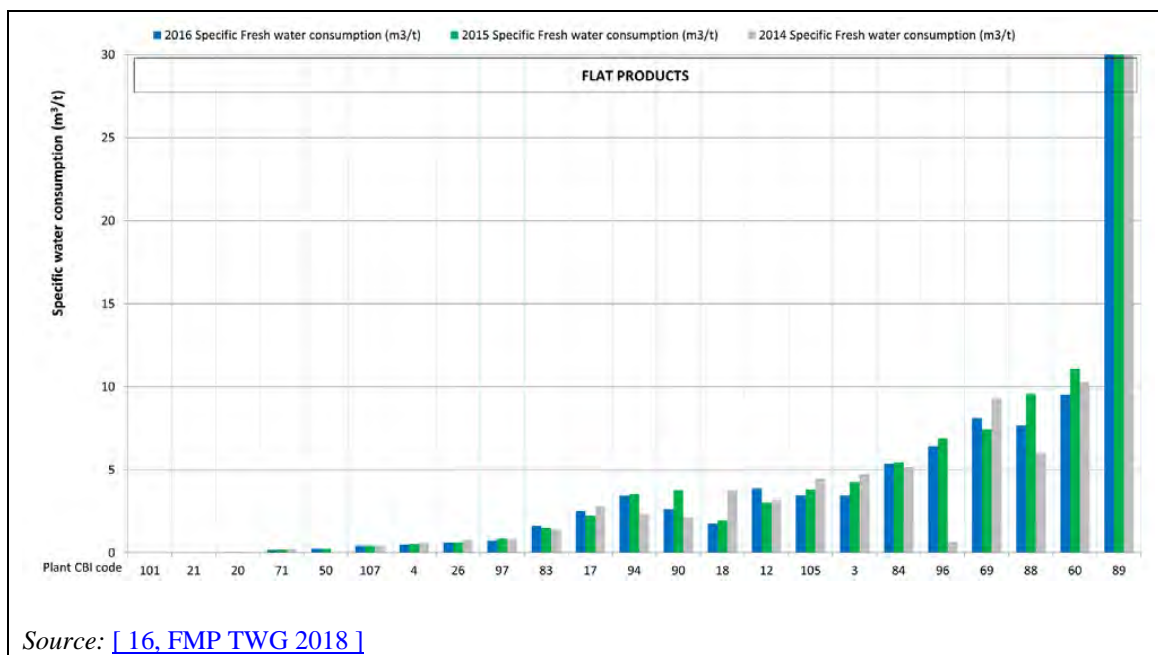


Figure 3.27: Specific HF consumption (kg/m² of treated surface) in cold rolling plants

3.3.4 Water consumption

Figure 3.28 shows the data reported on the specific water consumption, at plant level, for 3 operating years in the cold rolling plants who participated to the data collection. The specific water consumption ranged from 0.0002 m³/t to 74 m³/t for 23 plants in total. More specifically, according to the data collection, among the 7 CR plants that reported to be part of a much larger installation (i.e. integrated iron and steel works), a majority of the plants reported a specific consumption below or close to 10 m³/t, except one plant which reported a very high consumption of 74 m³/t, which is considered to be an outlier. The data in the figure are sorted in ascending order of the maximum specific water consumption values for the three operating years. The definition of the specific water consumption can be found in Section 9.4.4.2.



Source: [16, FMP TWG 2018]

Figure 3.28: Specific water consumption (m³/t of feedstock processed) in cold rolling plants

3.3.5 Emissions to air

3.3.5.1 Emissions to air from mechanical processing and welding

Dust emissions

The data reported on dust emissions to air from mechanical processing and welding are shown in Figure 3.31 and Figure 3.32. Emissions of dust were reported for 42 emission points in total. The emission concentrations ranged from 0.1 mg/Nm³ to 35.4 mg/Nm³ and the emission loads ranged from 8.5 g/h to 1 650 g/h.

Lead emissions

The data reported on lead emissions to air from descaling before pickling are shown in Figure 3.33. Emissions of lead were reported for 3 emission points in total. The reported emission concentrations ranged from 0.001 mg/Nm³ to 0.003 mg/Nm³ and the emission loads ranged from 0.12 g/h to 0.15 g/h.

Nickel emissions

The data reported on nickel emissions to air from descaling before pickling are shown in Figure 3.34. The emission concentrations of nickel were reported for 5 emission points in total. The reported emission concentrations ranged from 0.001 mg/Nm³ to 0.9 mg/Nm³ and the emission loads ranged from 0.05 g/h to 27 g/h.

3.3.5.2 Emissions to air from heating (annealing)

The emission concentrations presented in this section refers to emissions to air for feedstock heating in annealing (i.e. annealing before pickling, batch and continuous annealing after rolling). The figures takes into account whether the fuel composition for the reported maximum concentration refers to 100% natural gas or to fuels other than 100% natural gas. The presented concentration values for emissions to air from combustion refer to a common oxygen concentration of 3 %.

Dust emissions

The reported data on dust emissions to air for 15 emission points from feedstock heating (annealing before pickling and batch and continuous annealing after rolling) using 100% natural gas are shown in Figure 3.35. The dust emission concentrations ranged from 0.2 mg/Nm³ to 237 mg/Nm³ and the dust emission loads ranged from 4.0 g/h to 1 024 g/h.

Figure 3.36 shows the dust emissions to air for 3 emission points from feedstock heating (batch annealing after rolling) for fuels other than 100% natural gas. The emission concentrations ranged from 34.6 mg/Nm³ to 77.1 mg/Nm³ and the emission loads ranged from 155 g/h to 270 g/h.

SO₂ emissions

The reported data on SO₂ emissions to air for 9 emission points from feedstock heating (annealing before pickling and batch and continuous annealing after rolling) using 100% natural gas are shown in Figure 3.37. The emission concentrations ranged from 7.2 mg/Nm³ to 81.4 mg/Nm³ and the emission loads ranged from 19.5 g/h to 608 g/h.

The reported data on SO₂ emissions to air for 5 emission points from feedstock heating (annealing before pickling and batch and continuous annealing after rolling) for fuels other than 100% natural gas are shown in Figure 3.38. The emission concentrations ranged from 66 mg/Nm³ to 810 mg/Nm³ and the emission loads range from 468 g/h to 1 900 g/h.

NO_x emissions**Specific aspects to consider in batch annealing**

Figure 3.29 shows the NO_x emissions and relevant parameters during an annealing cycle for a natural gas fired bell annealing furnace at C.D. Wälzholz cold rolling mill (corresponding to plant/emission point 115 CR-1 in the data collection). The furnace is equipped with low-NO_x burners and a recuperative system for preheating of combustion air. In batch annealing, when using recuperators, the preheating of the combustion air is often limited to 400°C but higher temperatures are possible. Plant 115 CR operates with a maximum air preheating temperature of 550°C. The preheating temperature varies over the annealing cycle as it is related to the furnace temperature and the resulting waste gas temperature. The NO_x emissions in Figure 3.29 follow a similar curve as the preheating temperature, albeit with a slight delay. [92, EUROFER 2019] This is a clear indication that NO_x emissions are related to the air preheating of the combustion air. In addition, air preheating can save up to 25 % of the energy consumption and therefore is also important for energy efficiency. [3, EUROFER 2020]

In the first hour, while energy consumption is high and the temperature of the preheated combustion air is low, the NO_x emission concentration is only half of the maximum value observed over the whole annealing cycle. During the phase when the heating hood temperature is reduced (in order to not overheat the coils), the natural gas consumption is lowered step by step. At that stage, the air preheating is reduced and thus less NO_x is generated. The mass flow of NO_x in mg/h is related to the consumption of the natural gas or in other words to the burner power. [3, EUROFER 2020], [92, EUROFER 2019]

For periodic NO_x measurements, the time of measuring (i.e. how far into the annealing cycle) or the duration of the monitoring exercise may have an effect on the results. For example, in Figure

3.29, periodic measurements (3 samples taken over the duration of the monitoring exercise of 2 hours) were reported in the data collection for three years with concentration values of 250 mg/Nm³, 260 mg/Nm³ and 280 mg/Nm³ (at 5 % O₂), corresponding to 281 mg/Nm³, 293 mg/Nm³ and 315 mg/Nm³ (at 3 % O₂). However, the maximum of the continuous measured data as shown below in Figure 3.29 is 200 ppm (at 5 % O₂), corresponding to 450 mg/Nm³ (at 3 % O₂).

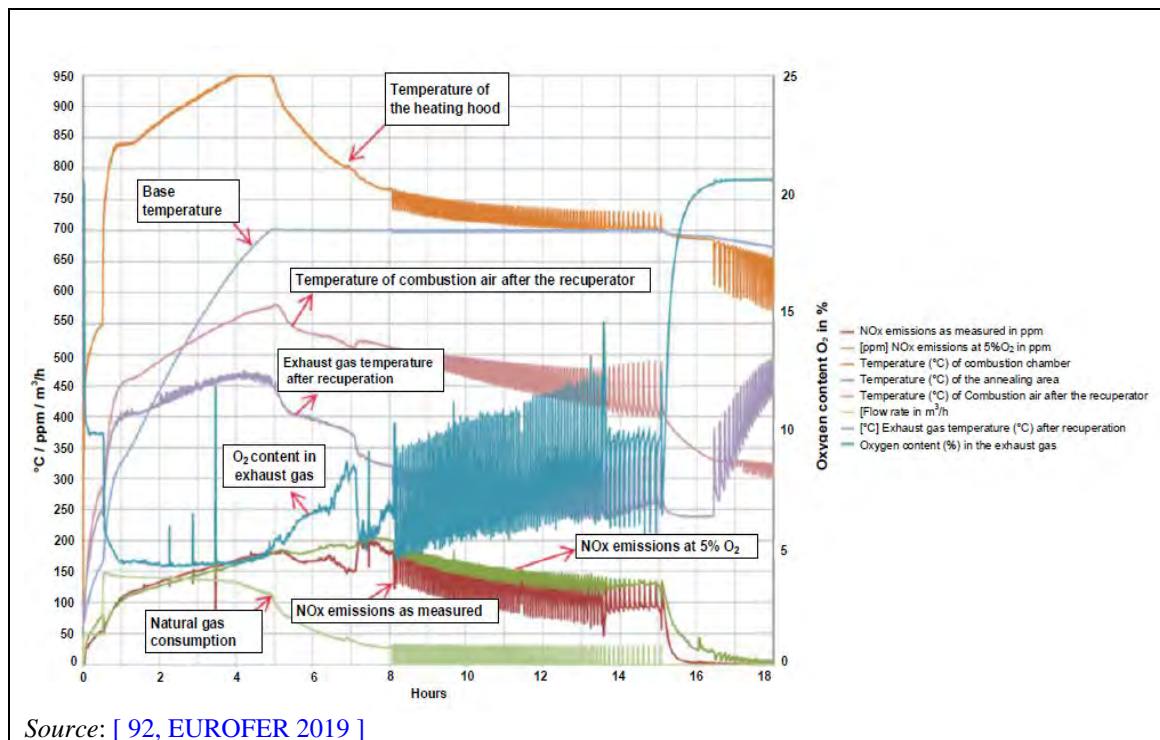


Figure 3.29: Example of parameters of a charge during the heating phase and the related emissions of NO_x (in ppm) including specific aspects to consider when measuring NO_x emissions from batch annealing furnaces, in particular the influence of air preheating on NO_x emissions.

Figure 3.30 shows NO_x emission concentrations over the annealing cycle for C.D. Wälzholz cold rolling mill (corresponding to plant/emission point 115 CR-1 in the data collection) For the first annealing cycle (in blue), the burner power is 85% and the maximum NO_x concentration is about 220 ppm (at 5 % O₂), with an average of 132 ppm over the annealing cycle; corresponding to a maximum concentration of 555 mg/Nm³ and an average concentration of 300 mg/Nm³ at 3 % O₂. For the second annealing cycle (in green), the burner power is 100% and the maximum concentration is about 190 ppm (at 5 % O₂), with an average of 151 ppm over the entire annealing cycle; corresponding to a maximum concentration of 430 mg/Nm³ and an average concentration of 350 mg/Nm³ at 3 % O₂. During the data collection, this plant reported NO_x emission concentrations within the range 250 mg/Nm³ to 280 mg/Nm³ (at 5 % O₂).

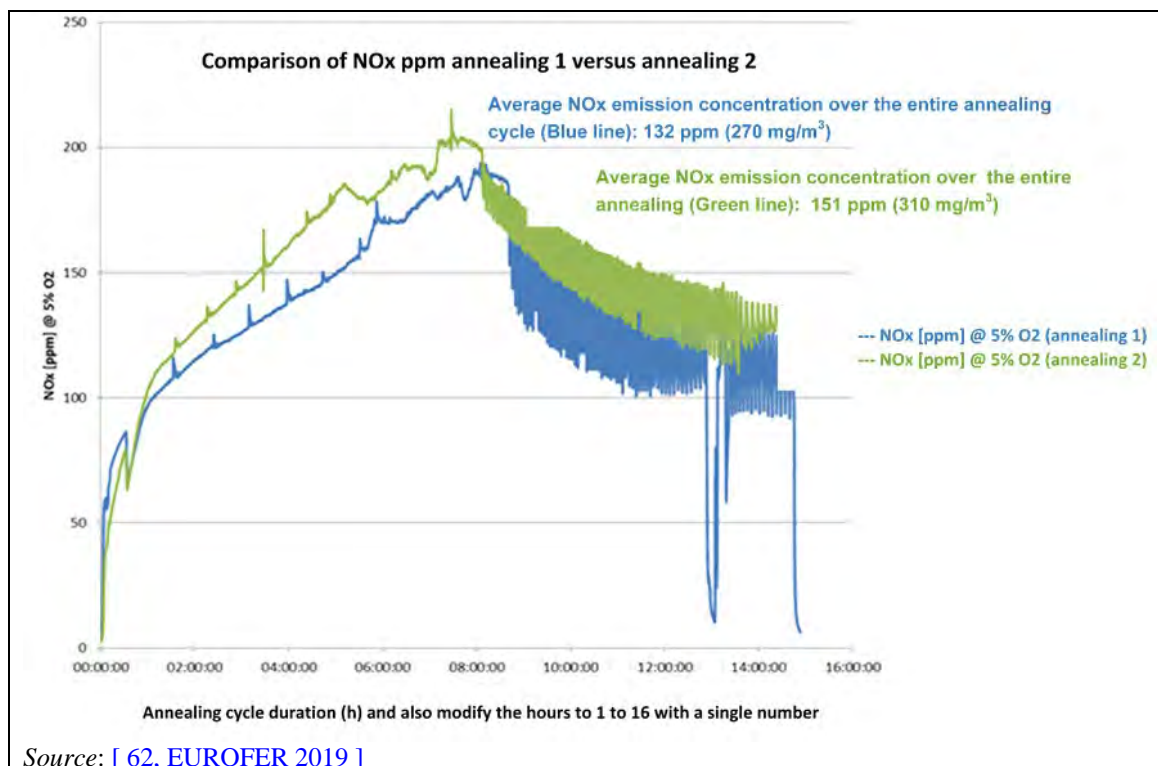


Figure 3.30: Test example of NO_x emissions (in ppm) and the influence of the power of the burner over the entire annealing cycle at C.D. Wälzholz cold rolling mill showing differences between the average emission concentration over the annealing cycle and the maximum emission concentration

Summary of the NO_x emission concentrations reported in the FMP data collection

The reported data on NO_x emissions to air for 37 emission points from feedstock heating (annealing before pickling and batch, continuous and bright annealing after rolling) using 100% natural gas are shown in Figure 3.39. The emission concentrations ranged from 62.0 mg/Nm³ to 1 274 mg/Nm³ and the emission loads ranged from 291 g/h to 61 800 g/h.

The reported data on NO_x emissions to air from feedstock heating (annealing before pickling and batch and continuous annealing after rolling) for fuels other than 100% natural gas is reported for 8 emission points in total and is shown in Figure 3.40. The emission concentrations ranged from 259 mg/Nm³ to 1 260 mg/Nm³ and the emission loads ranged from 728 g/h to 5 600 g/h.

Table 3.5 shows the emission concentration ranges and emission loads of NO_x to air from feedstock heating without air preheating and with air preheating.

Table 3.5: Ranges of NO_x emissions to air from feedstock heating in annealing without air preheating and with air preheating

	Natural gas		Fuels other than 100 % natural gas	
	mg/Nm ³	g/h	mg/Nm ³	g/h
Without air preheating	63-691	91-19 000	312-1 260	728-1 050
With air preheating	62-1 274	291-61 000	25-945	2 600-27 000

Source: [16, FMP TWG 2018]

Figure 3.41 and Figure 3.43 show the reported data on NO_x emissions to air from feedstock heating (annealing before pickling and batch, continuous and bright annealing after rolling) for 100% natural gas without and with air preheating, respectively.

Figure 3.42 and Figure 3.44 show the reported data on NO_x emissions to air from feedstock heating (annealing before pickling and batch and continuous annealing after rolling) for fuels other than 100% natural gas without and with air preheating, respectively.

CO emissions

The reported data on CO emissions to air for 21 emission points from feedstock heating (annealing before pickling and batch and continuous annealing after rolling) using 100% natural gas is shown in Figure 3.45. The emission concentrations ranged from 4.4 mg/Nm³ to 2 800 mg/Nm³ and the emission loads ranged from 70 g/h to 96 000 g/h.

The reported data on CO emissions to air for 4 emission points from feedstock heating (batch and continuous annealing after rolling) for fuels other than 100% natural gas are shown in Figure 3.38. The emission concentrations ranged from 30 mg/Nm³ to 540 mg/Nm³ and the emission loads ranged from 18 g/h to 1 700 g/h.

3.3.5.3 Emissions to air from pickling

Dust emissions

The reported data on dust emissions to air from pickling are shown in Figure 3.47. The figure includes 8 emission points from hot rolling plants (HR in the plant code), 4 emission points from cold rolling plants (CR in the plant code) as well as 1 emission point from a hot dip coating plant (HDC in the plant code). The dust emission concentrations ranged from 0.6 mg/Nm³ to 18.0 mg/Nm³ and the emission loads ranged from 11 g/h to 255 g/h.

HCl emissions

The reported data on HCl emissions to air from pickling are shown in Figure 3.48. The figure includes 7 emission points from hot rolling plants (HR in the plant code), 22 emission points from cold rolling plants (CR in the plant code) as well as 1 emission point from a hot dip coating plant (HDC in the plant code). The HCl emission concentrations ranged from 0.4 mg/Nm³ to 78.0 mg/Nm³ and the emission loads ranged from 0.02 g/h to 1 390 g/h.

SO_x emissions

The reported data on SO_x emissions to air from pickling are shown in Figure 3.49. The figure includes 12 emission points from hot rolling plants (HR in the plant code) as well as 7 emission points from cold rolling plants (CR in the plant code). The SO_x emission concentrations ranged from 0.1 mg/Nm³ to 12.9 mg/Nm³ and the emission loads ranged from 0.9 g/h to 332 g/h.

NO_x emissions

The reported data on NO_x emissions to air from pickling are shown in Figure 3.50. The figure includes 16 emission points from hot rolling plants (HR in the plant code) as well as 13 emission points from cold rolling plants (CR in the plant code). The NO_x emission concentrations ranged from 1.0 mg/Nm³ to 478 mg/Nm³ and the emission loads ranged from 15 g/h to 7 300 g/h.

HF emissions

The reported data on HF emissions to air from pickling are shown in Figure 3.51. The figure includes 15 emission points from hot rolling plants (HR in the plant code) as well as 13 emission points from cold rolling plants (CR in the plant code). The HF emission concentrations ranged from 0.03 mg/Nm³ to 46.0 mg/Nm³ and the emission loads ranged from 0.07 g/h to 640 g/h.

3.3.5.4 Emissions to air from rolling stands and finishing

TVOC emissions

The reported data on TVOC emissions to air from rolling stands and finishing are shown in Figure 3.52. The emissions of TVOC were reported for 21 emission points. The TVOC emission concentrations ranged from 0.2 mg/Nm³ to 26.2 mg/Nm³ and the emission loads ranged from 16.8 g/h to 2 200 g/h.

3.3.5.5 Figures with air emission concentrations

The figures related to emissions to air which are presented here are composed of several sections. The upper part of the figure always shows the maximum concentration for each of the three reporting years and the average value obtained over the reporting period. For combustion processes (annealing), the plotted concentration values always refer to an oxygen reference level of 3 % and information on the type of fuel(s) used is also included. Measurements reported without giving information about the oxygen level measured or the fuel composition used are not taken into account. Below the x-axis, additional contextual information is included such as the emission point code, the type of steel products and the steel category, the number of measurements done each year and the BAT candidates used. In the lower part of the figure, additional information may be also given such as the mass flow values, both for the maximum concentration obtained over the reporting period and the average mass flow over the three reporting years. Typically, a figure is available for cases where 100% natural gas is used, and a separate figure is provided for fuels other than 100% natural gas indicating clearly the type of fuel mix used (expressed as percentages of energy input). In the case of figures related to NO_x emissions, an additional graph showing the corresponding emissions of CO is provided in the lower part of of the figure. In all cases, the figures are sorted in ascending order of the maximum concentration values for the three operating years. The explanations for the abbreviations used in the graphs can be found in the glossary.

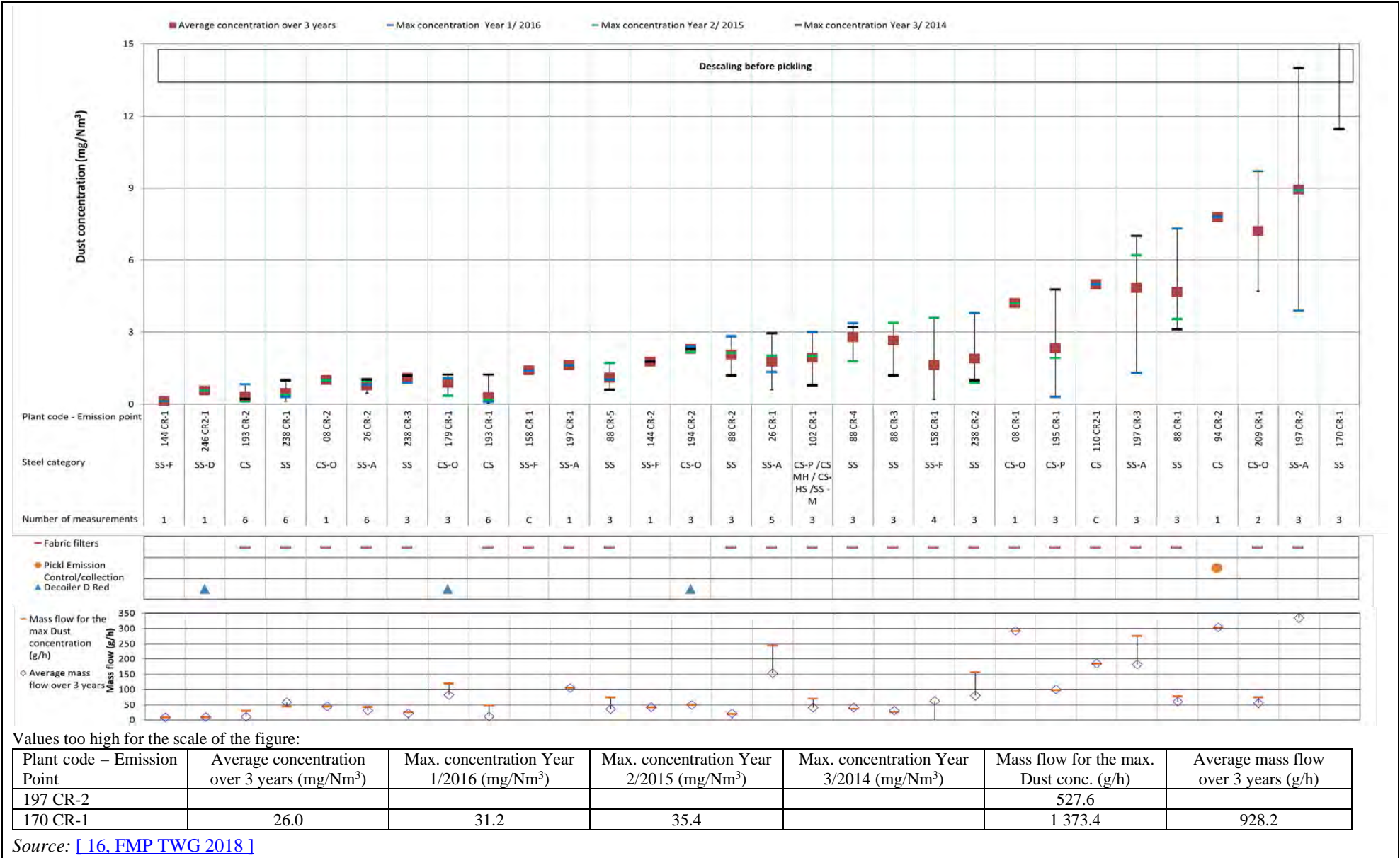


Figure 3.31: Dust emissions from mechanical processing and welding – Part 1 of 2

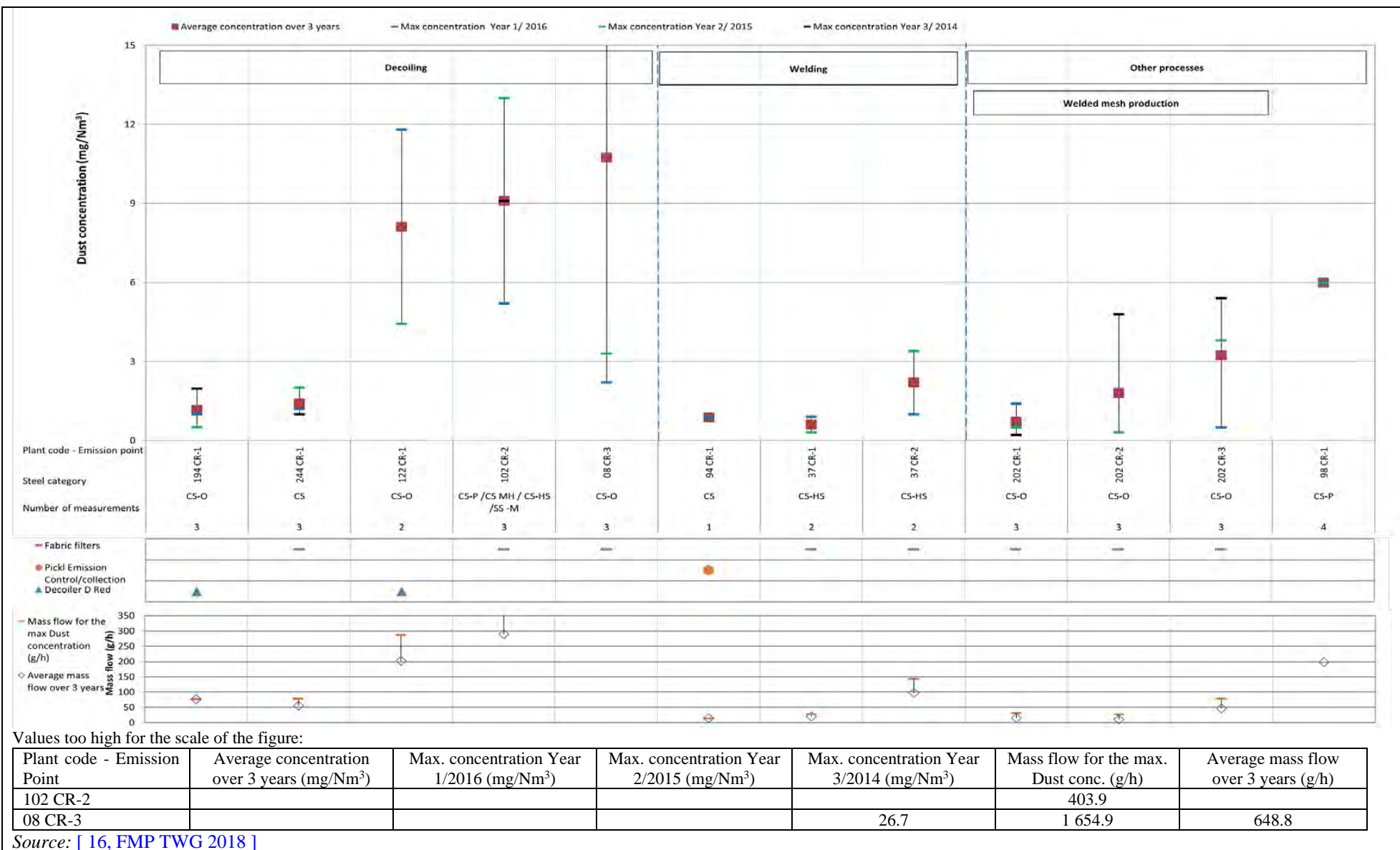


Figure 3.32: Dust emissions from mechanical processing and welding – Part 2 of 2



Source: [16, FMP TWG 2018]

Figure 3.33: Lead emissions from descaling before pickling

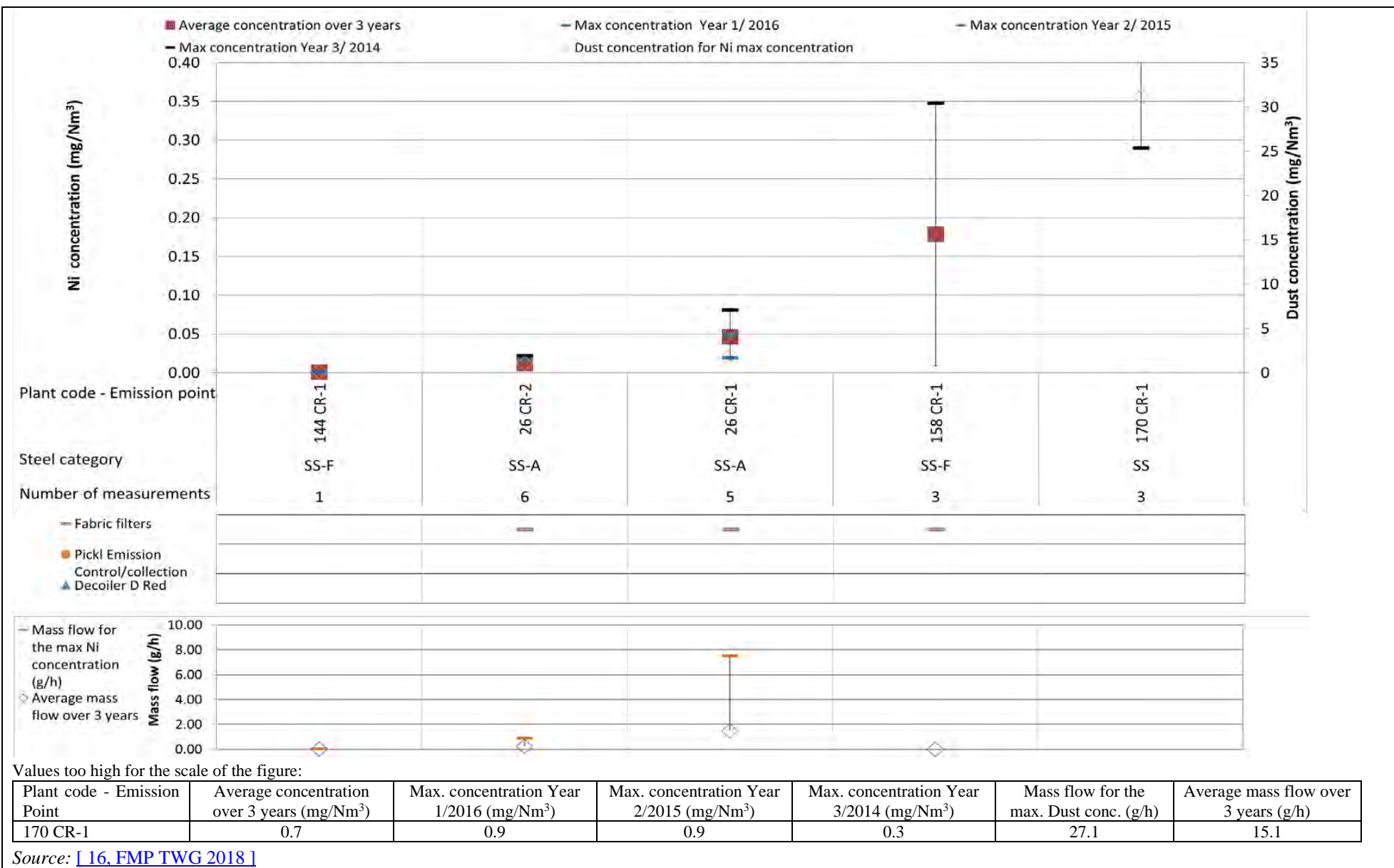
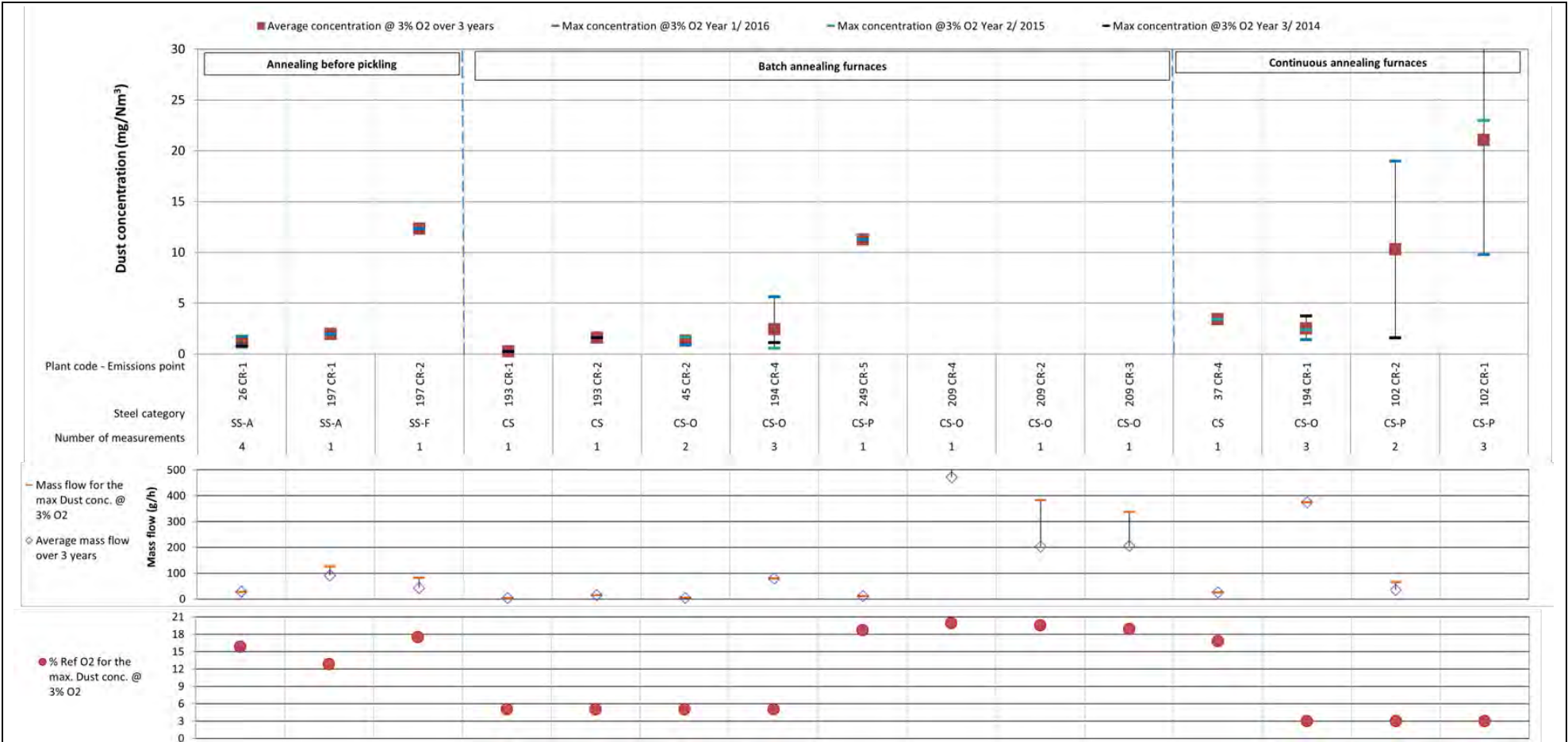


Figure 3.34: Nickel emissions from descaling before pickling



Values too high for the scale of the figure:

Plant code - Emission Point	Average concentration over 3 years (mg/Nm ³)	Max. concentration Year 1/2016 (mg/Nm ³)	Max. concentration Year 2/2015 (mg/Nm ³)	Max. concentration Year 3/2014 (mg/Nm ³)	Mass flow for the max. Dust conc. @ 3 % O ₂ (g/h)	Average mass flow over 3 years (g/h)
209 CR-4	178.4	178.4			848.0	
209 CR-2	235.2	235.2				
209 CR-3	237.4	237.4				
102 CR-1				30.7	1 025.0	828

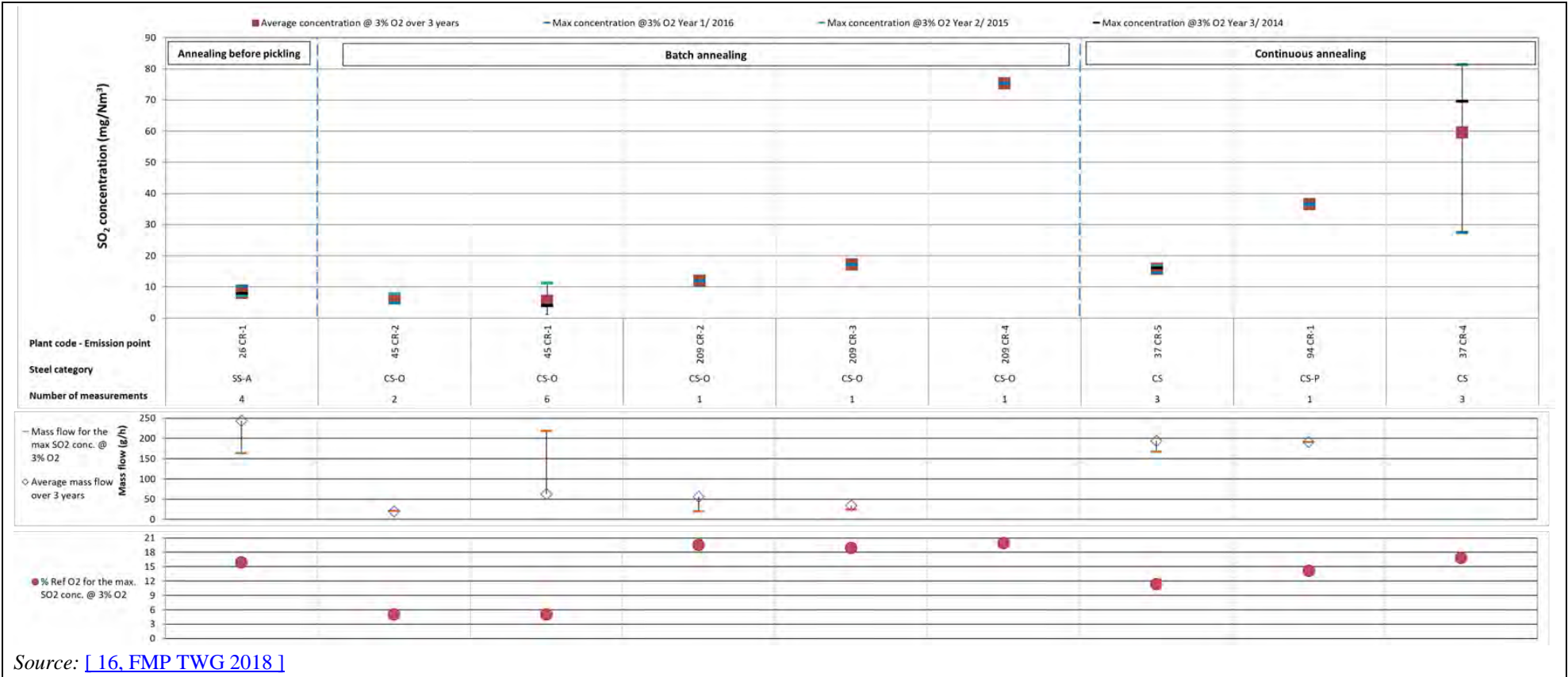
Source: [16, FMP TWG 2018]

Figure 3.35: Dust emissions from feedstock heating (in mg/Nm³ at 3 % oxygen) using 100 % natural gas



Source: [16, FMP TWG 2018]

Figure 3.36: Dust emissions from feedstock heating (in mg/Nm³ at 3 % oxygen) for fuels other than 100 % natural gas

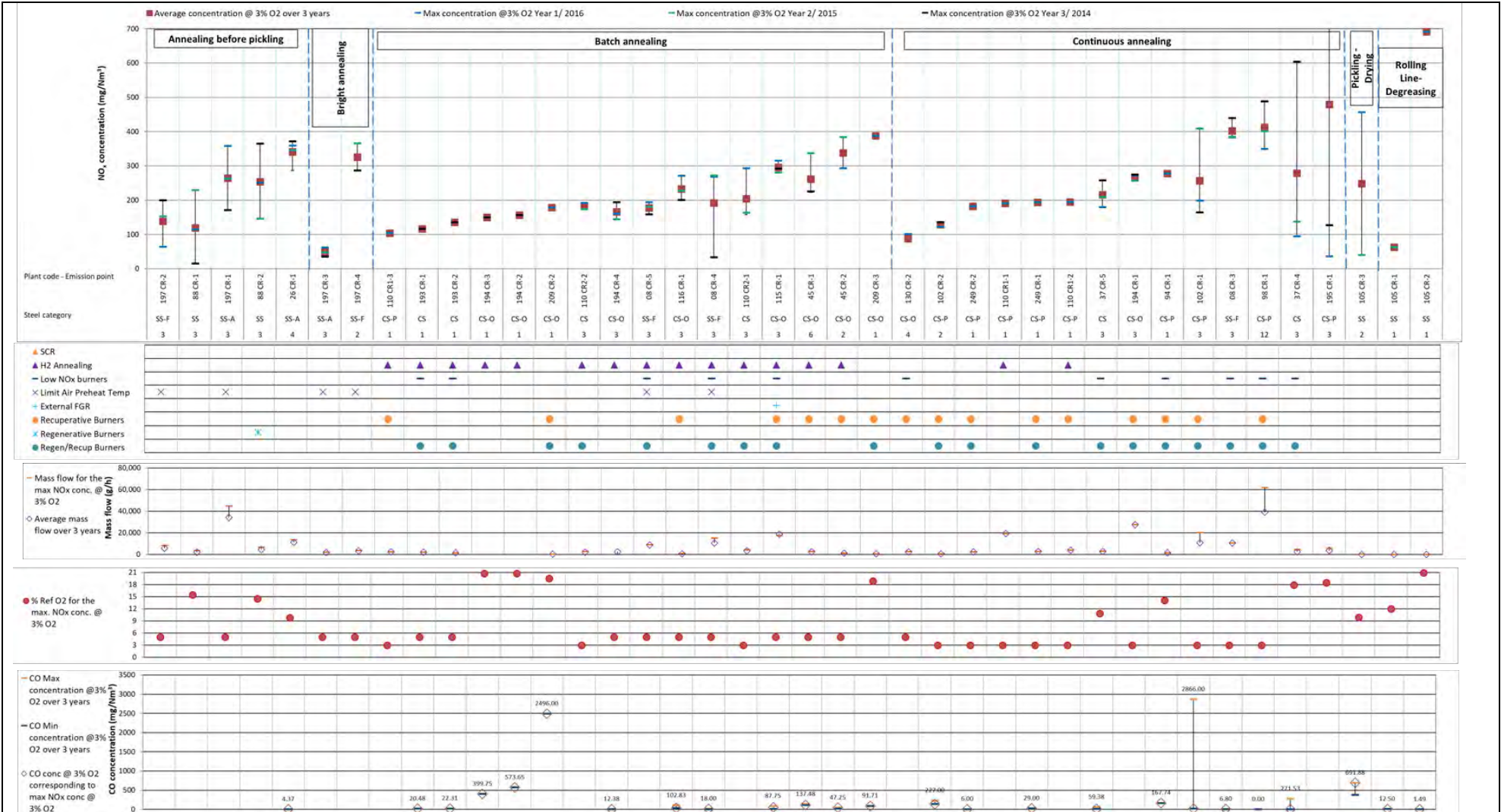


Source: [16, FMP TWG 2018]

Figure 3.37: SO₂ emissions from feedstock heating (in mg/Nm³ at 3 % oxygen) using 100 % natural gas



Figure 3.38: SO₂ emissions from feedstock heating (in mg/Nm³ at 3 % oxygen) for fuels other than 100 % natural gas



Values too high for the scale of the figure:

Plant code - Emission Point	Average concentration over 3 years (mg/Nm ³)	Max. concentration Year 1/2016 (mg/Nm ³)	Max. concentration Year 2/2015 (mg/Nm ³)	Max. concentration Year 3/2014 (mg/Nm ³)
195 CR-1			1 274.4	

Source: [16, FMP TWG 2018]

Figure 3.39: NO_x emissions from feedstock heating (in mg/Nm³ at 3 % oxygen) using 100 % natural gas

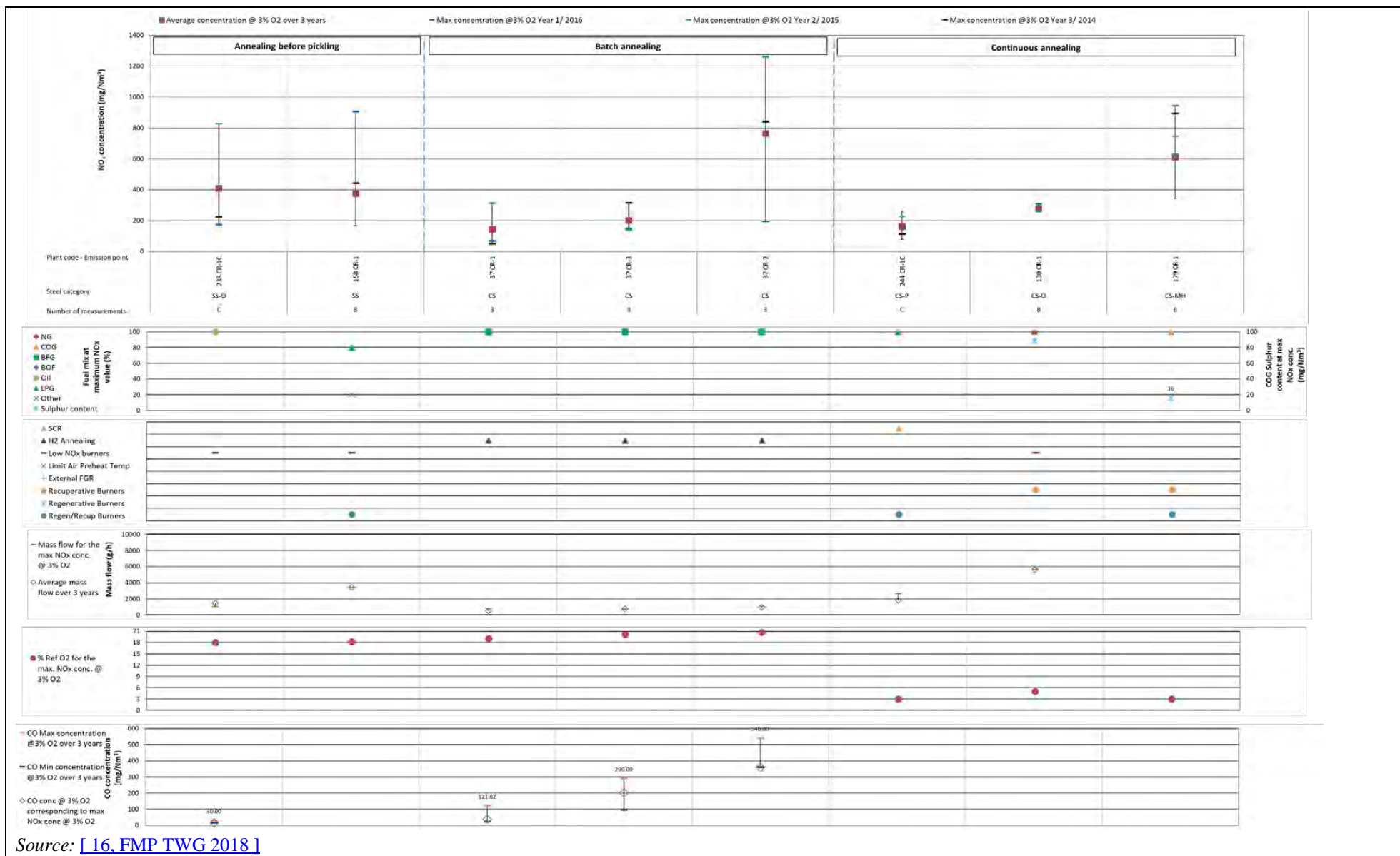


Figure 3.40: NO_x emissions from feedstock heating (in mg/Nm³ at 3 % oxygen) for fuels other than 100 % natural gas

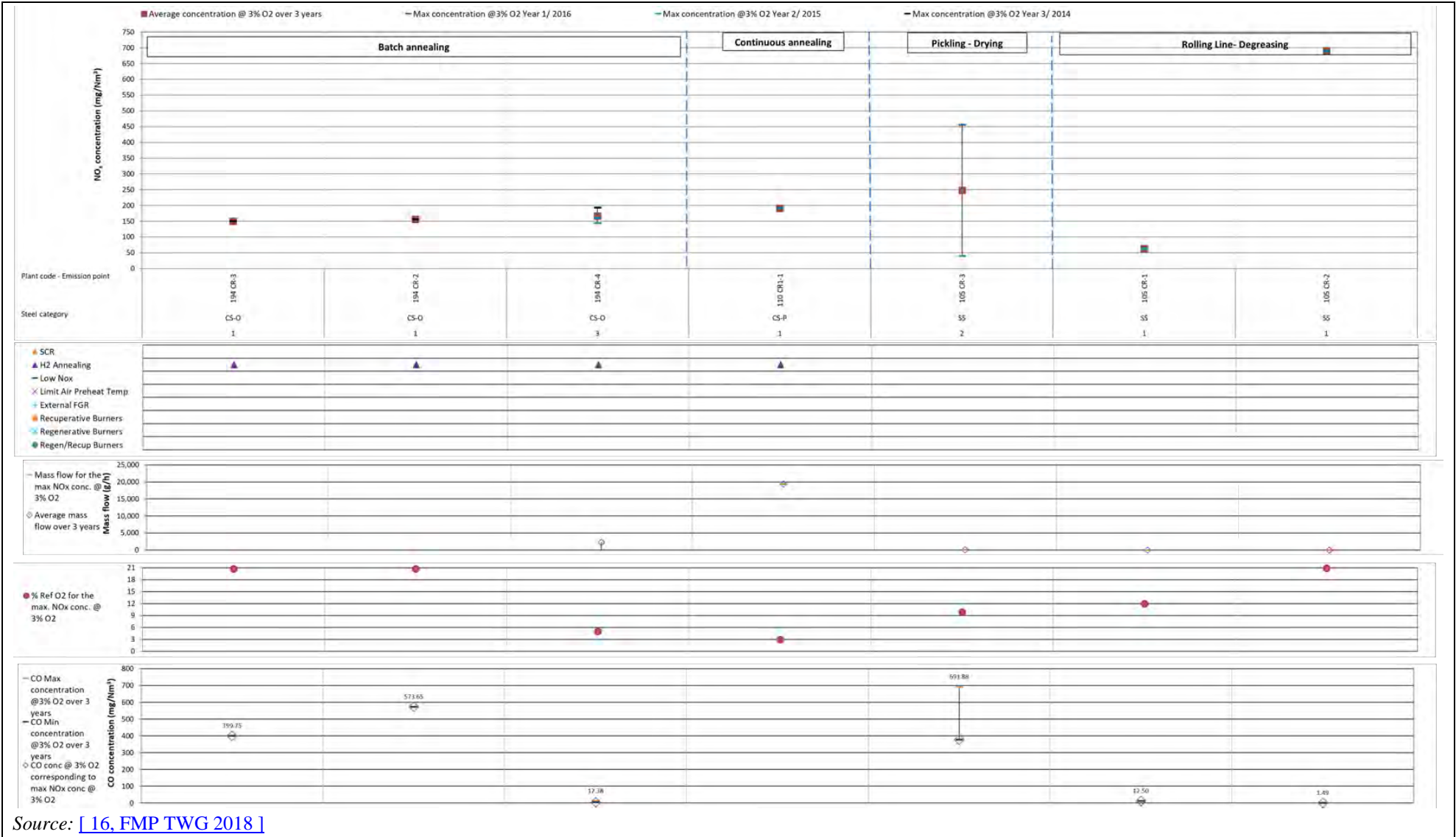
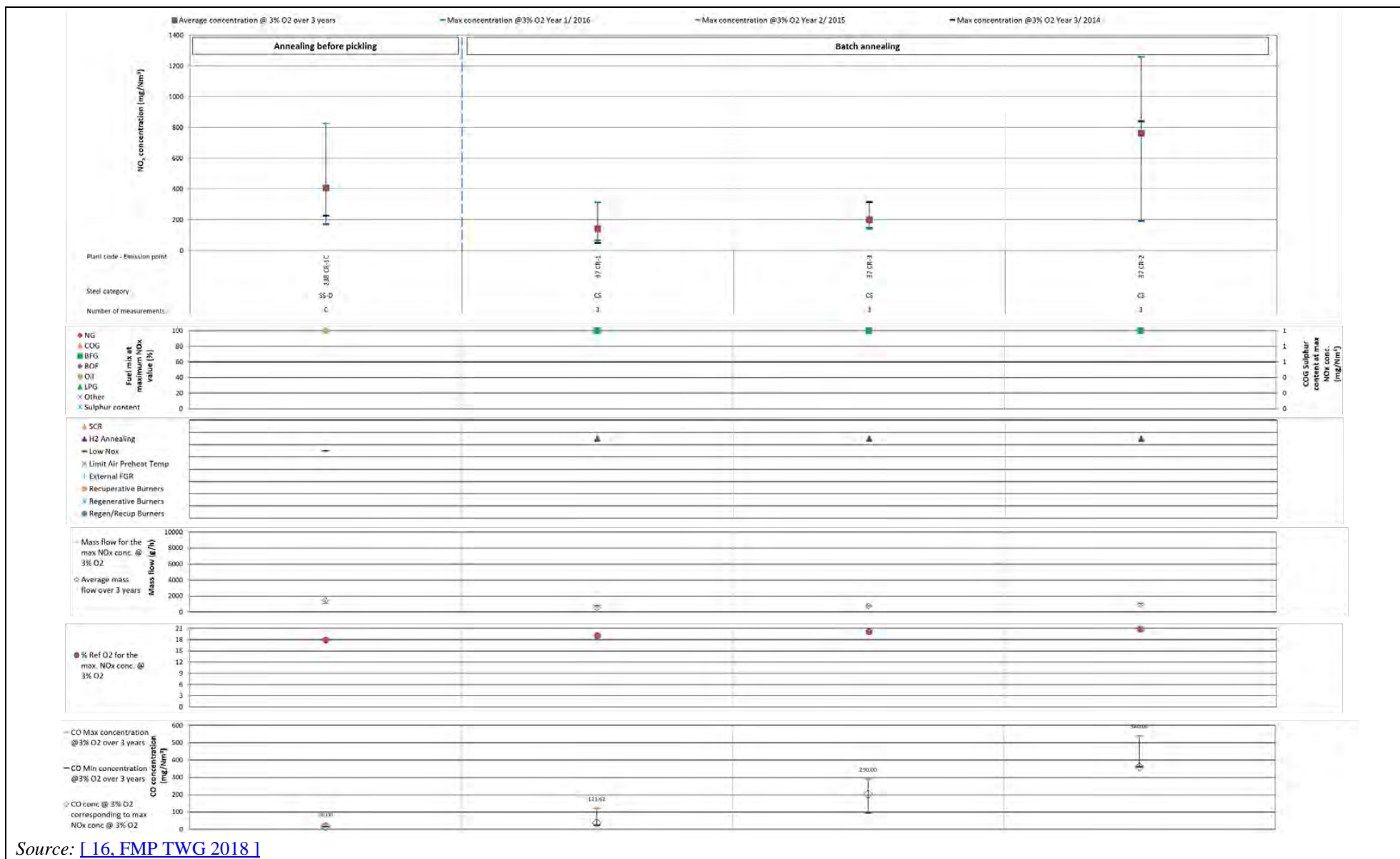


Figure 3.41: NOx emissions from feedstock heating (in mg/Nm³ at 3 % oxygen) using 100 % natural gas, without air preheating



Source: [16, FMP TWG 2018]

Figure 3.42: NO_x emissions from feedstock heating (in mg/Nm³ at 3 % oxygen) for fuels other than 100 % natural gas, without air preheating

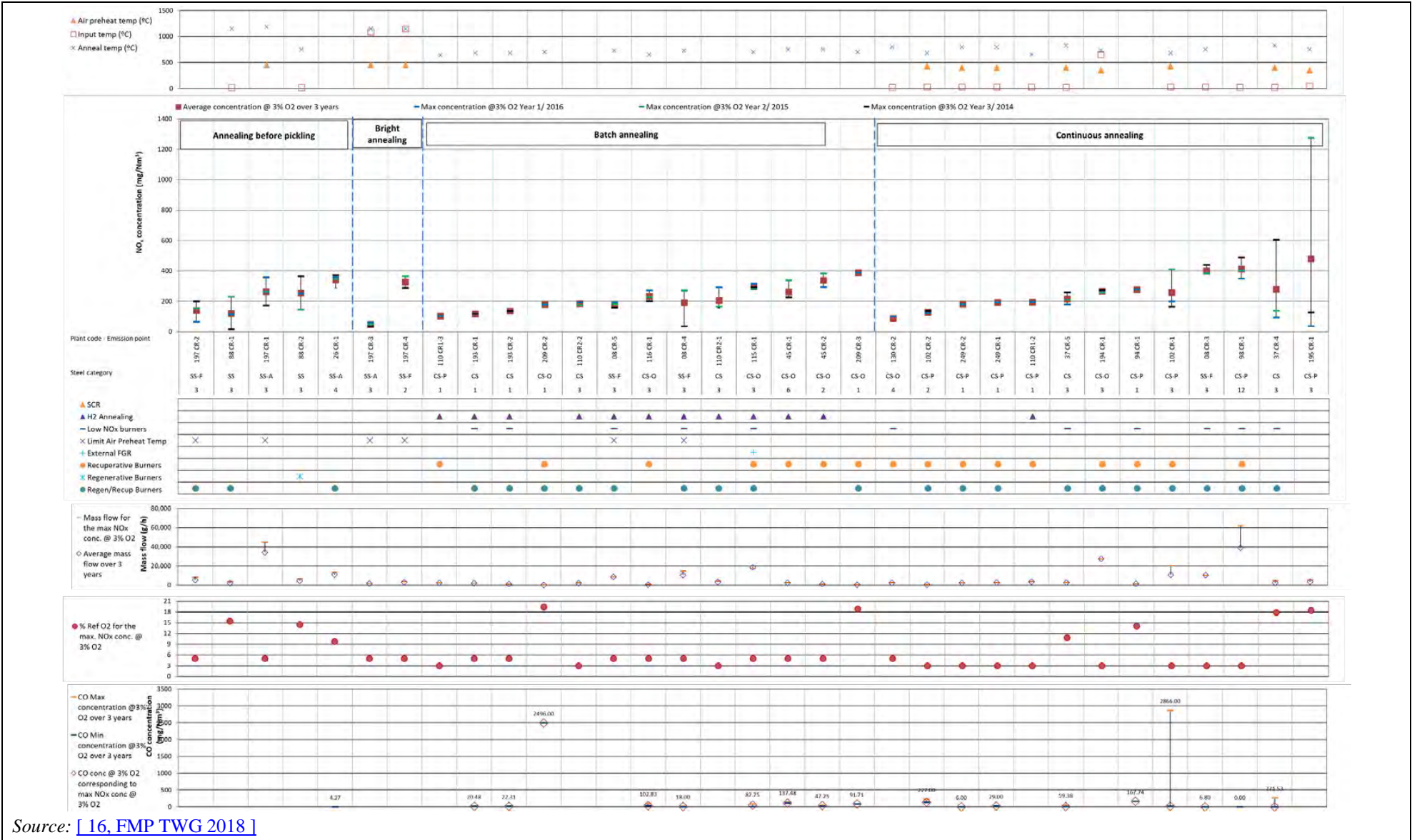
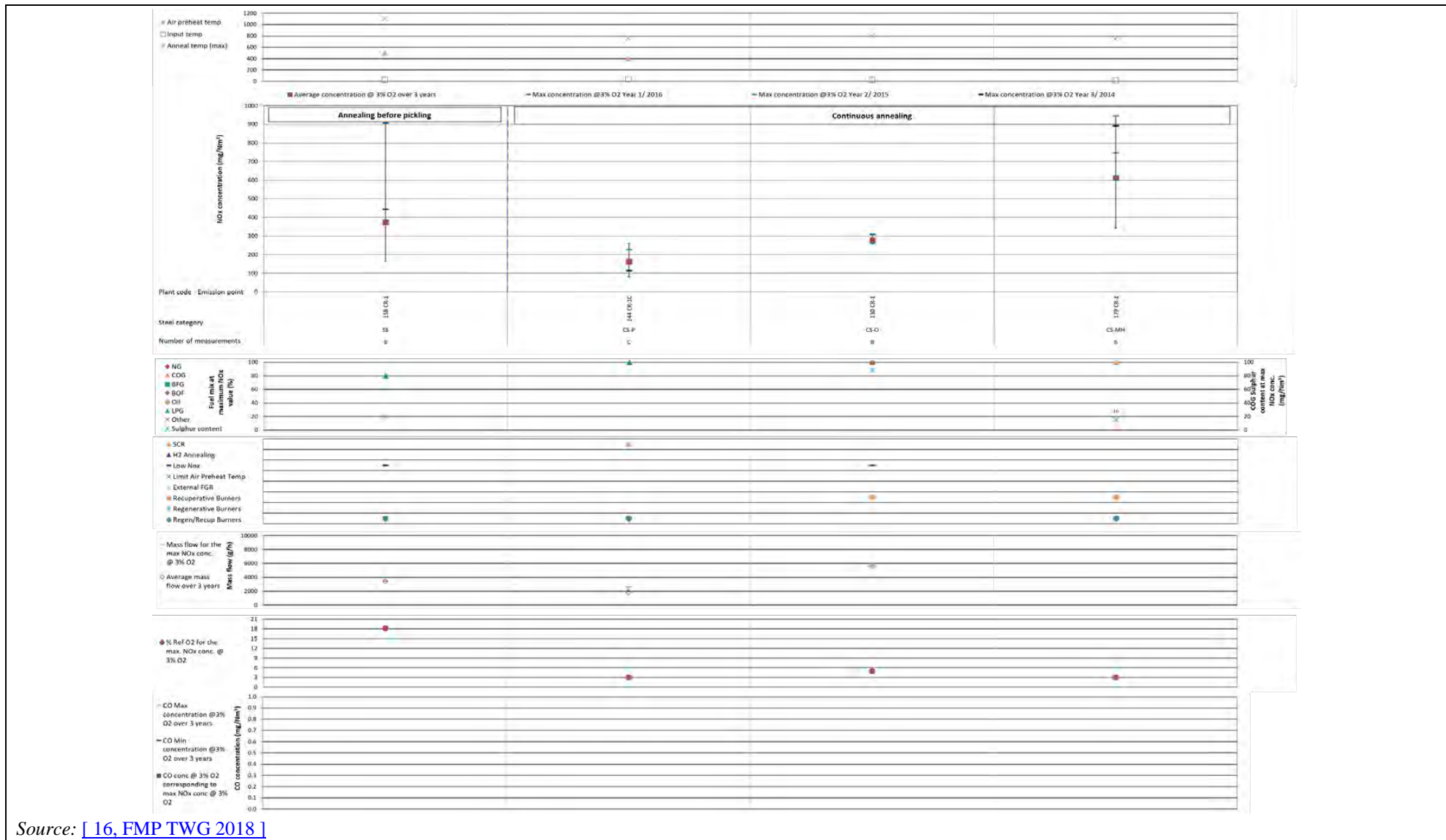
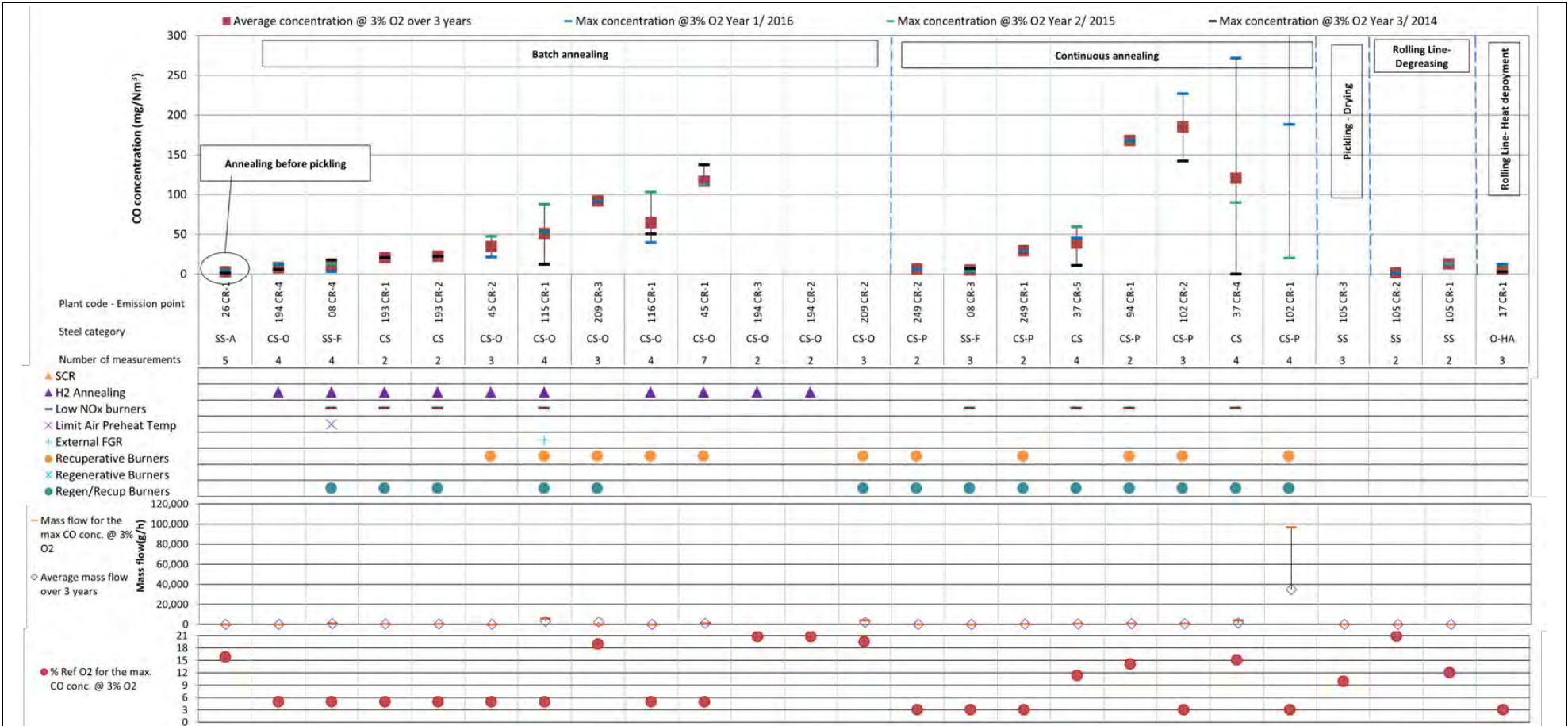


Figure 3.43: NOx emissions from feedstock heating (in mg/Nm³ at 3 % oxygen) using 100 % natural gas, with air preheating temperature and feedstock inlet and target temperature



Source: [16, FMP TWG 2018]

Figure 3.44: NO_x emissions from feedstock heating (in mg/Nm³ at 3 % oxygen) for fuels other than 100 % natural gas, with air preheating temperature and feedstock inlet and target temperature



Values too high for the scale of the figure:

Plant code - Emission Point	Average concentration over 3 years (mg/Nm ³)	Max. concentration Year 1/2016 (mg/Nm ³)	Max. concentration Year 2/2015 (mg/Nm ³)	Max. concentration Year 3/2014 (mg/Nm ³)
194 CR-3	399.8			399.8
194 CR-2	573.7			573.7
209 CR-2	2 496.0	2 496.0		
102 CR-1	1 024.7			2 866.0
105 CR-3	534.5	691.9	377.1	

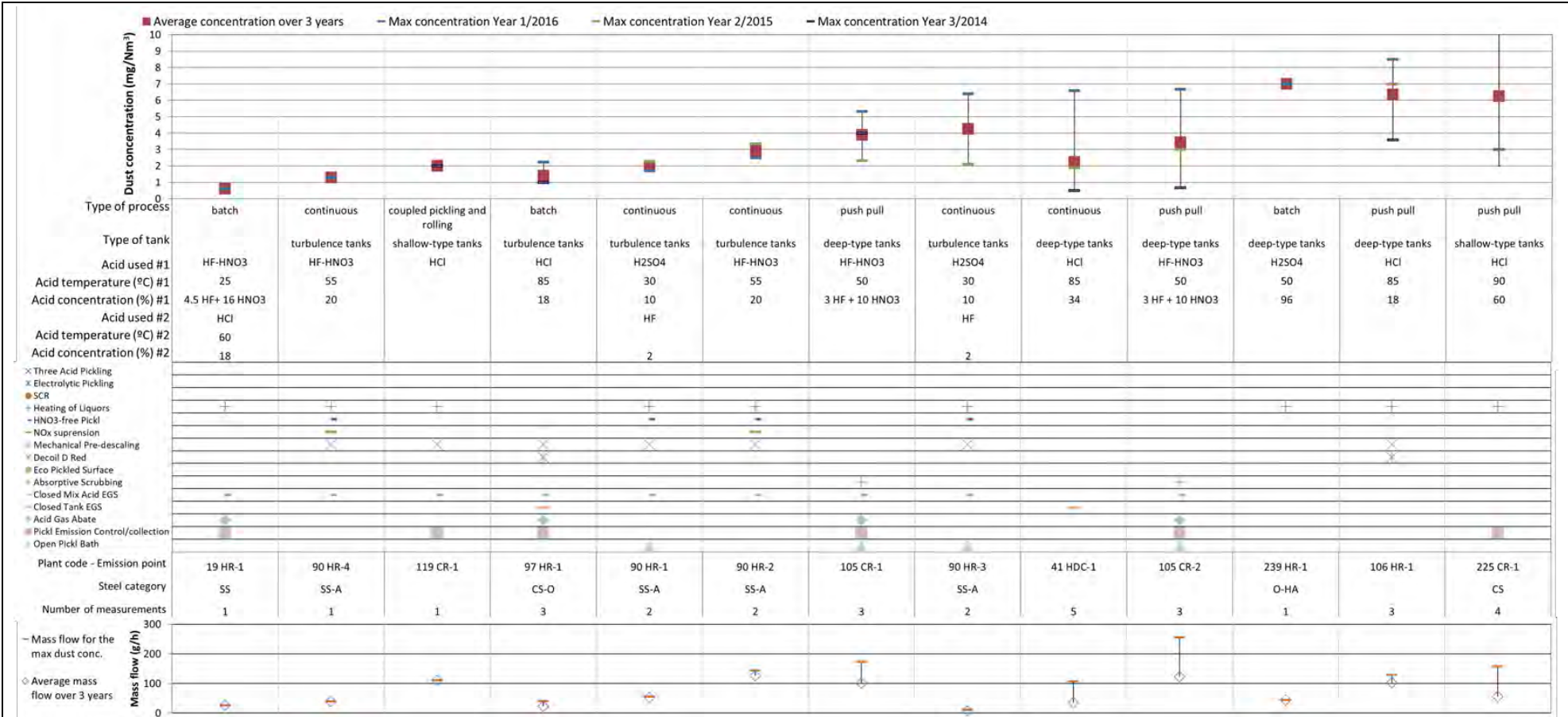
Source: [16, FMP TWG 2018]

Figure 3.45: CO emissions from feedstock heating (in mg/Nm³ at 3 % oxygen) using 100 % natural gas



Source: [16, FMP TWG 2018]

Figure 3.46: CO emissions from feedstock heating (in mg/Nm³ at 3 % oxygen) for fuels other than 100 % natural gas



Values too high for the scale of the figure:

Plant code - Emission Point	Average concentration over 3 years (mg/Nm³)	Max. concentration Year 1/2016 (mg/Nm³)	Max. concentration Year 2/2015 (mg/Nm³)	Max. concentration Year 3/2014 (mg/Nm³)
225 CR-1			18.0	

Source: [16, FMP TWG 2018]

Figure 3.47: Dust emissions from pickling (in mg/Nm³) in hot rolling, cold rolling and hot dip coating plants

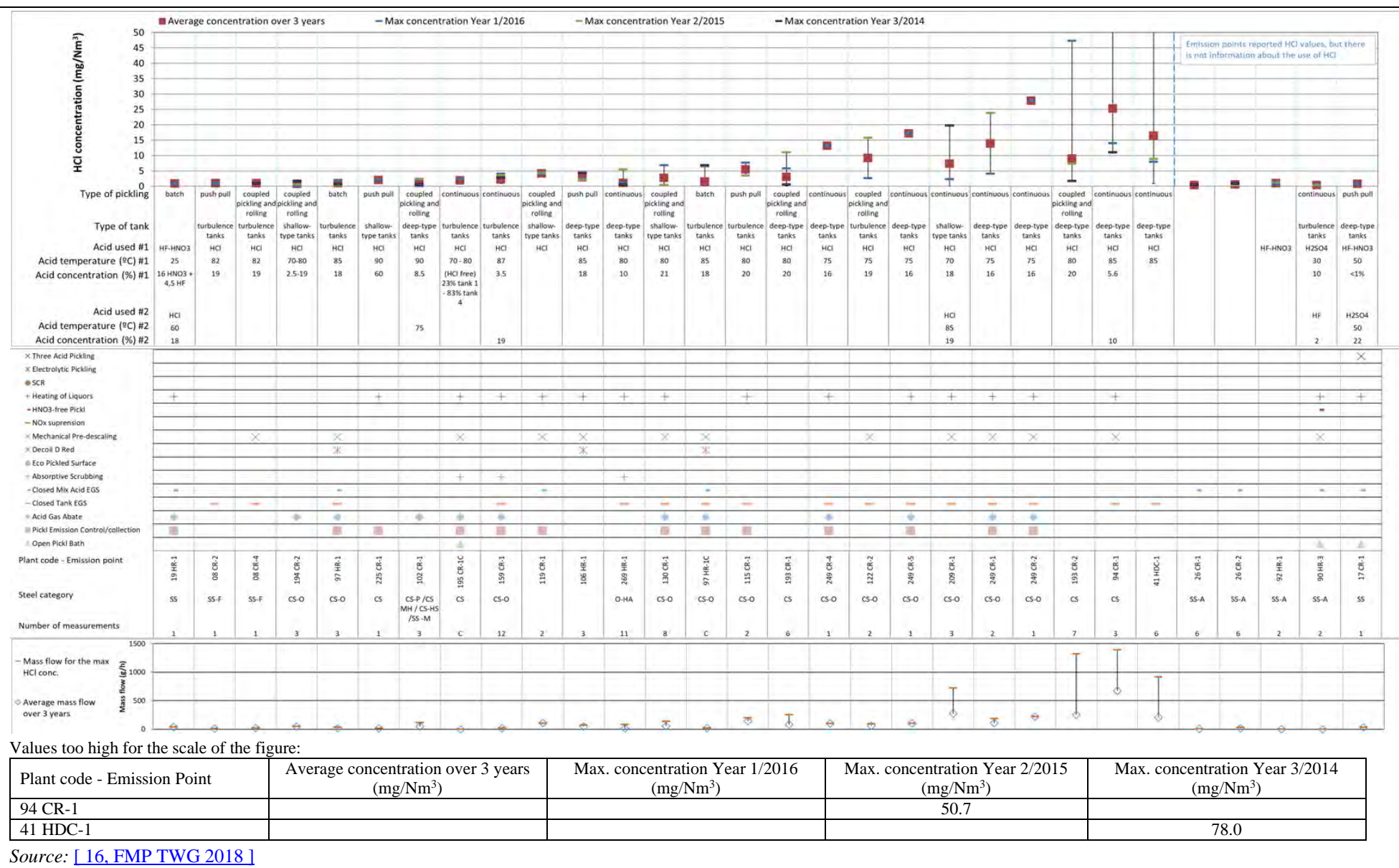


Figure 3.48: HCl emissions from pickling (in mg/Nm³) in hot rolling, cold rolling and hot dip coating plants

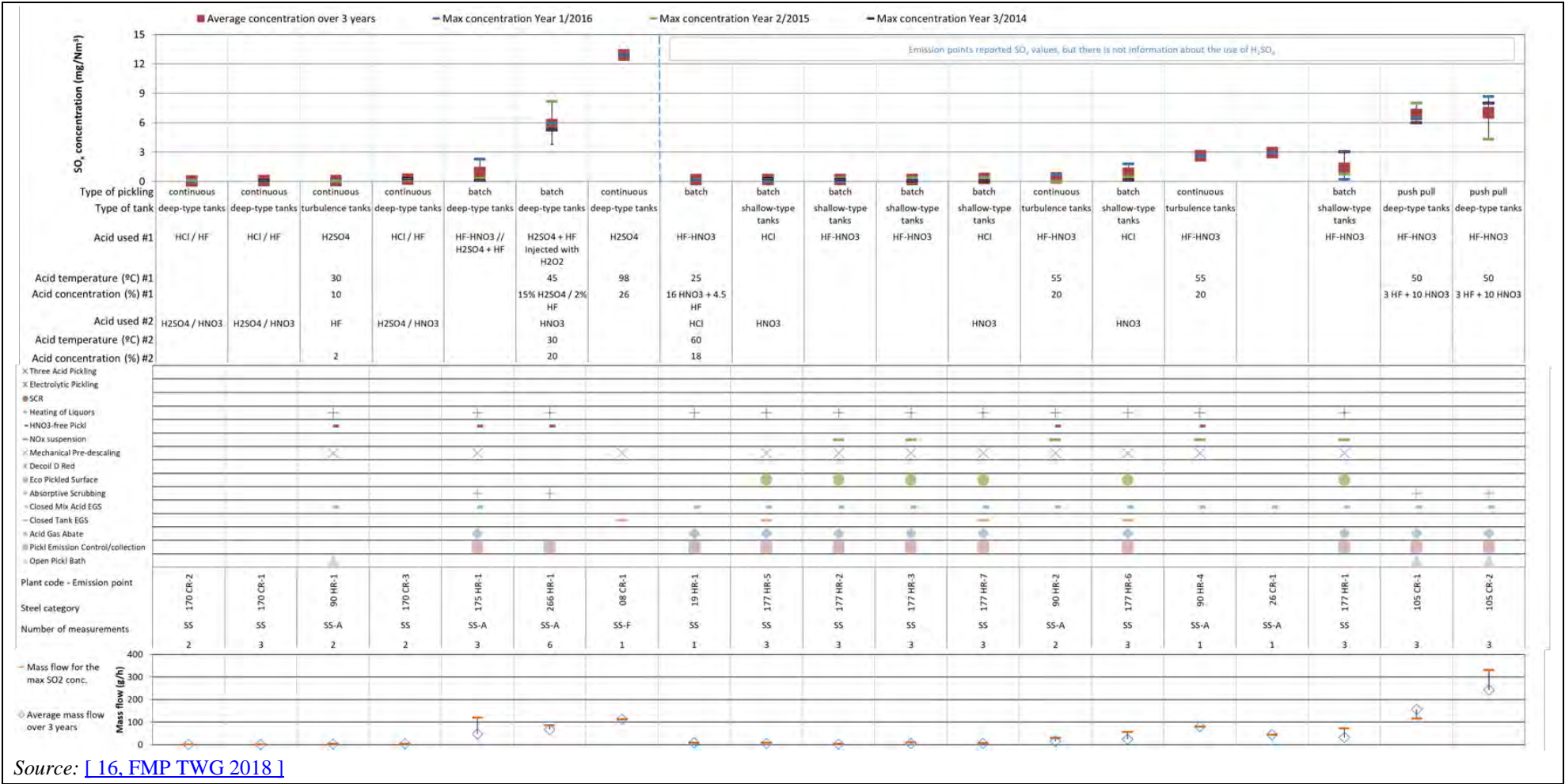
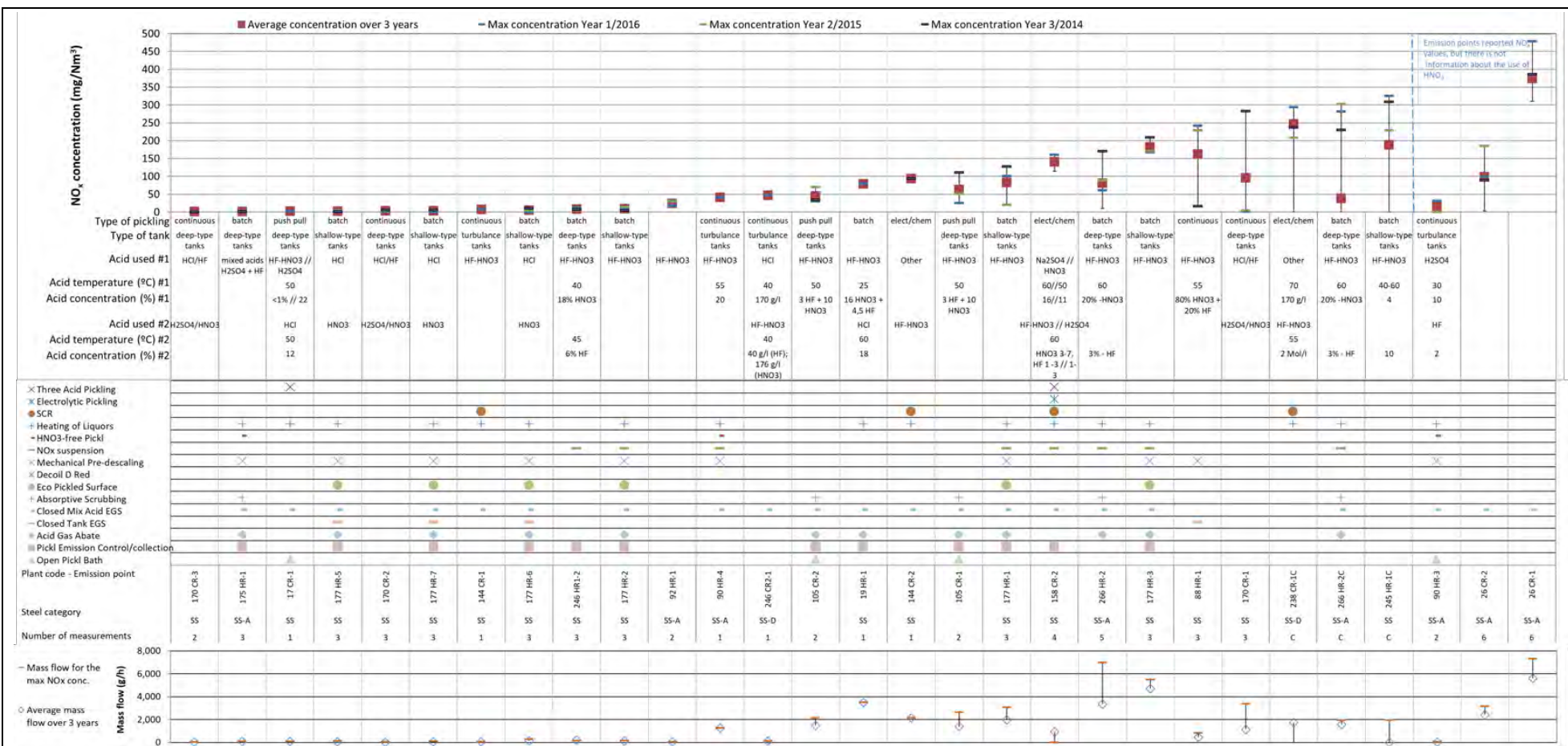
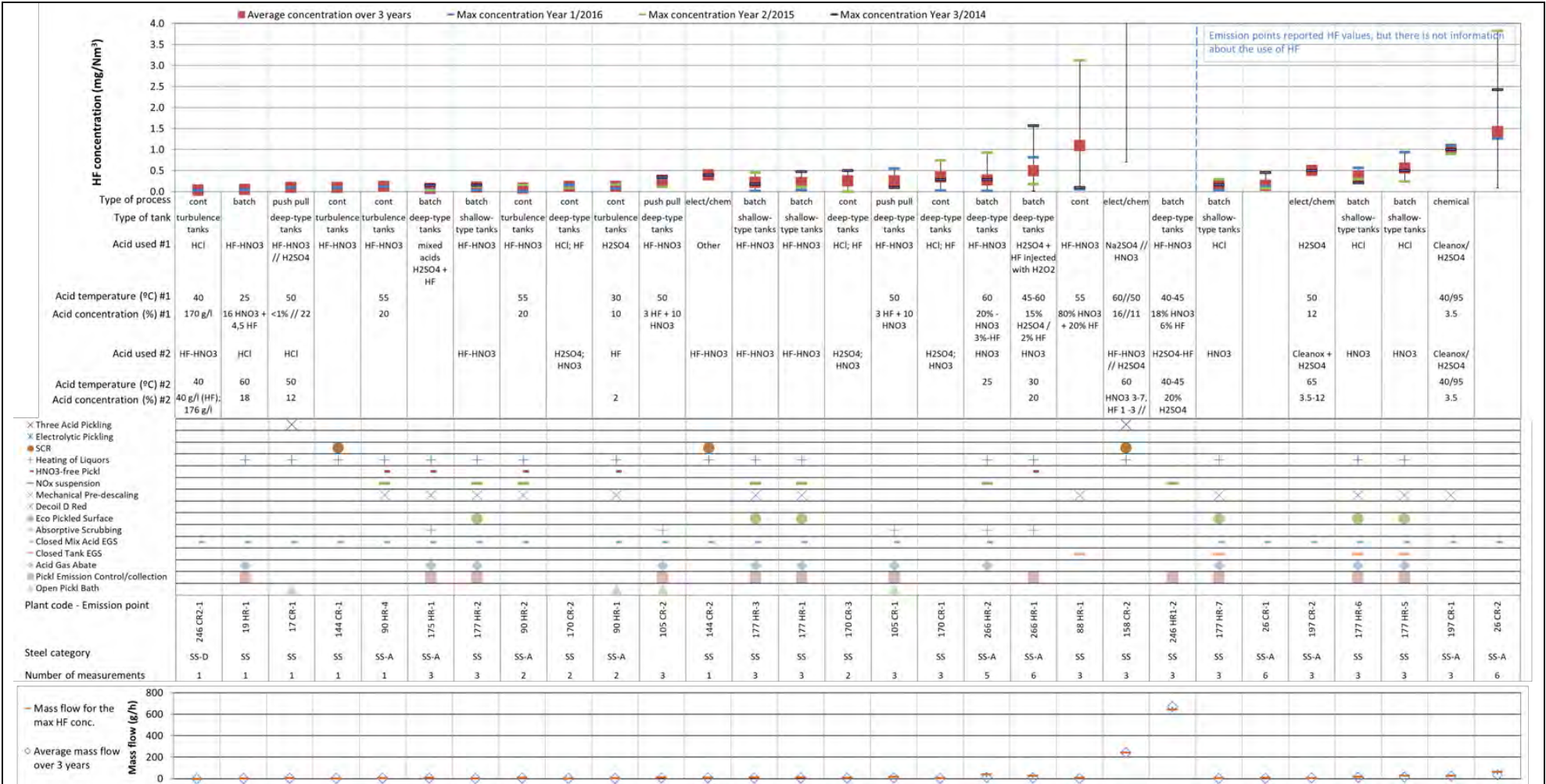


Figure 3.49: SO_x emissions from pickling (in mg/Nm³) in hot rolling and cold rolling plants



Source: [16, FMP TWG 2018]

Figure 3.50: NO_x emissions from pickling (in mg/Nm^3) in hot rolling and cold rolling plants



Values too high for the scale of the figure:

Plant code - Emission Point	Average concentration over 3 years (mg/Nm ³)	Max. concentration Year 1/2016 (mg/Nm ³)	Max. concentration Year 2/2015 (mg/Nm ³)	Max. concentration Year 3/2014 (mg/Nm ³)
158 CR-2	10.9	29.9		
246 HR1-2	29.3	46.0	22.0	20.0

Source: [16, FMP TWG 2018]

Figure 3.51: HF emissions from pickling (in mg/Nm³) in hot rolling and cold rolling plants

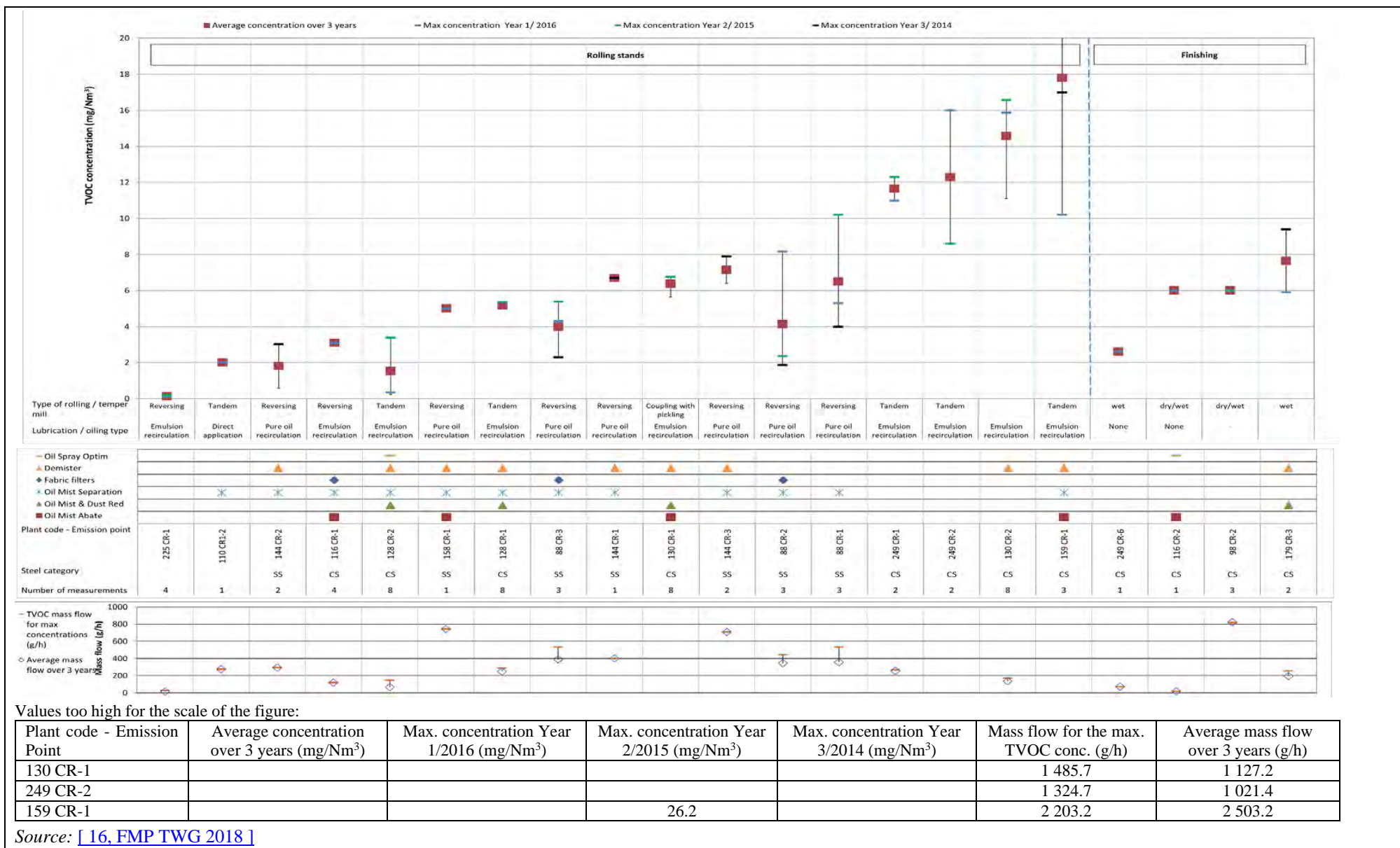


Figure 3.52: TVOC emissions from rolling stands and finishing (in mg/Nm³)

3.3.6 Emissions to water

All the data related to emissions to water from CR processes are presented in Section 7.2.1 of the document where figures depicting emissions to water for all sectors are presented in a merged format.

3.3.7 Residues

Table 3.6, Table 3.7 and Table 3.8 show the reported data on the specific generation of oil-containing residues, scale and steel scrap for 3 operating years in the cold rolling plants that participated in the FMP data collection.

Table 3.6: Specific generation of oil-containing residues

Plant code	Steel product	Steel grade	Specific amount of oil-containing residues (kg/t)			Recycle in plant	EWC code	Classification
			2016	2015	2014			
225 CR	Other	CS-O	0.09	0.15	0.14	NI	19 02 07	Hazardous
232 CR	Stainless	SS-A, SS-D	3.81	3.67	4.31	No	NI	NI

NB: NI = No information.
 CS-O = CS-other (non-alloy/low-alloy).
 SS-A = SS-Austenitic.
 SS-D = SS-Duplex.
 Source: [16, FMP TWG 2018]

Table 3.7: Specific generation of scale residues

Plant code	Steel product	Steel grade	Specific amount of scale (kg/t)			Recycle in plant	EWC code	Classification
			2016	2015	2014			
170 CR	Stainless	SS-A, SS-F	3.10	2.92	3.09	NI	NI	NI
232 CR	Stainless	SS-A, SS-D	8.80	9.30	10.72	No	10 02 10	Non-hazardous
238 CR	Stainless	SS-D	4.58	4.63	3.50	Yes	10 02 10	Non-hazardous

NB: NI = No information.
 SS-A = SS-Austenitic.
 SS-D = SS-Duplex.
 SS-F = SS-Ferritic.
 Source: [16, FMP TWG 2018]

Table 3.8: Specific generation of steel scrap

Plant code	Steel product	Steel grade	Specific amount of steel scrap (kg/t)			Recycle in plant	EWC code	Classification
			2016	2015	2014			
225 CR	Other	CS-O	67.44	74.23	75.73	NI	Yes	19 12 02 12 01 01
232 CR	Stainless	SS-A, SS-D	3.70	2.40	1.34	No	Yes	17 04 07
238 CR	Stainless	SS-D	261.49	276.25	228.44	Yes	No	NI

NB: NI = No information.
 CS-O = CS-other (non-alloy/low-alloy).
 SS-A = SS-Austenitic.
 SS-D = SS-Duplex.
 Source: [16, FMP TWG 2018]

3.4 Techniques to consider in the determination of BAT for cold rolling

This section describes techniques (or combinations thereof), and associated monitoring, considered to have the potential for achieving a high level of environmental protection in the activities within the scope of this document. The techniques described will include both the technology used and the way in which the installations are designed, built, maintained, operated and decommissioned.

It covers environmental management systems as well as process-integrated and end-of-pipe techniques. Waste prevention and management, including waste minimisation and recycling procedures, are also considered, as well as techniques that reduce the consumption of raw materials, water and energy by optimising use and reuse. The techniques described also cover the prevention or limiting of the environmental consequences of accidents and incidents. They also cover the prevention or reduction of emissions under other than normal operating conditions (such as start-up and shutdown operations, leaks, malfunctions, momentary stoppages and the definitive cessation of operations).

Annex III to the Directive lists a number of criteria for determining BAT, and the information within this chapter will address these considerations. As far as possible, the standard structure in Table 2.15 is used to outline the information on each technique, to enable a comparison of techniques and the assessment against the definition of BAT in the Directive.

This chapter does not necessarily provide an exhaustive list of techniques that could be applied in the sector. Other techniques may exist, or may be developed, which could be considered in the determination of BAT for an individual installation.

In Chapter 8, general techniques (i.e. those used that are commonly used) are discussed which might also be applicable to cold rolling. These techniques are normally not repeated in this section, unless information specific for this sector was made available.

3.4.1 Pickling

3.4.1.1 Laser welding machine

Description

A laser welding machine is used in the input section of a continuous pickling line, or in the input section of a coupled pickling and tandem cold rolling mill¹ for welding the edges (head and tail) of successive coils being processed.

Technical description

The welding process, using laser technology, is based on the phenomenon of localised melting of the steel at the point of impact of the laser beam. The principle of generation and operation of the laser is essentially based on three phases:

- Absorption: phase during which it is necessary to externally provide a certain amount of energy to excite electrons of the chemical species which originates from the laser.
- Emission: process associated with subsequent electron excitement that causes a certain amount of energy that is released and goes to excite in turn other neighboring atoms.
- Amplification: through the adoption of a system of reflective mirrors which facilitates the process of spontaneous emission.

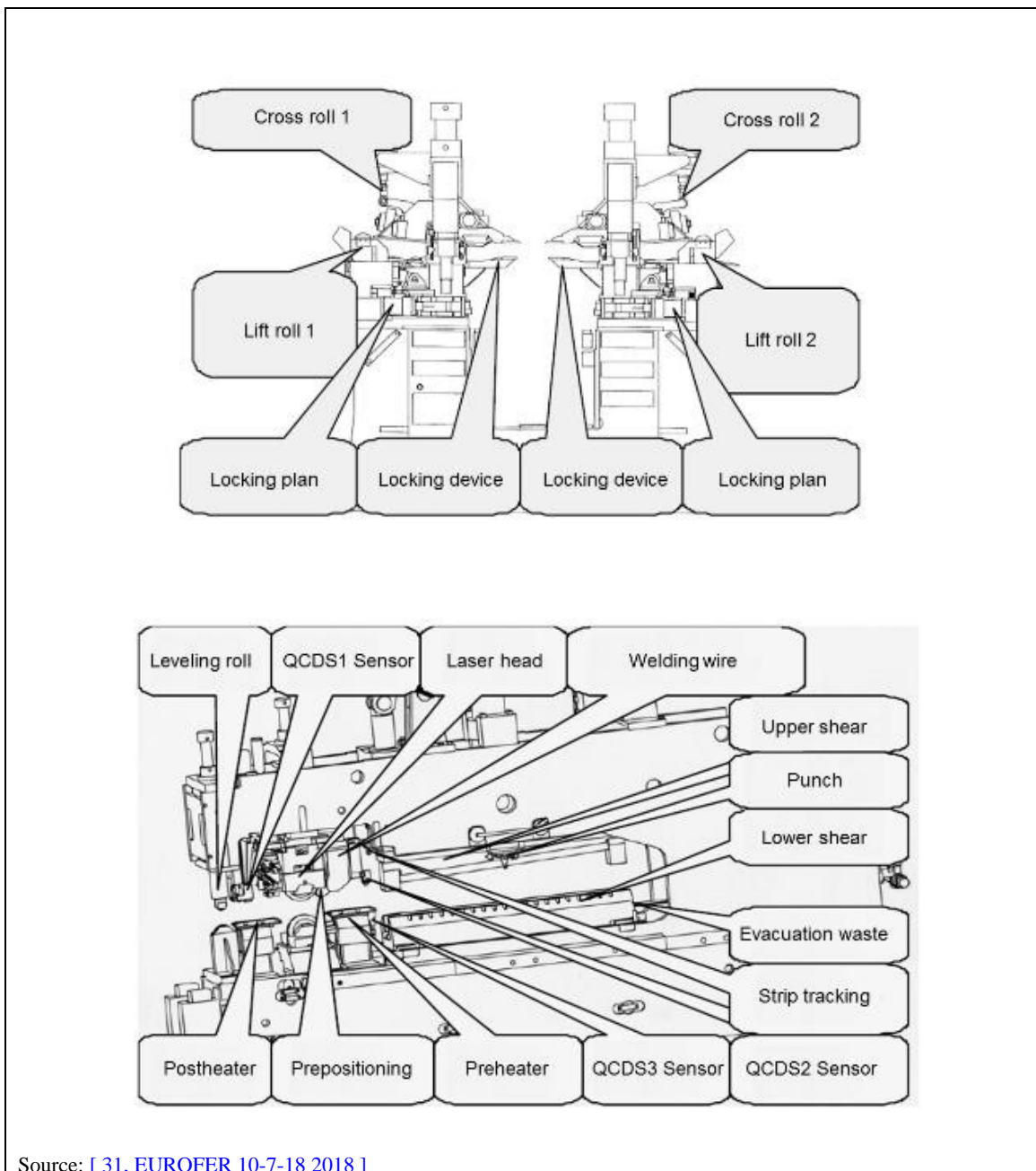
The laser welding is a process with high energy density that can be obtained by adjusting the focal point of the optical system. Part of the base material vaporises, forming a zone which contains the vapors which are generated called “keyhole”. The molten material subsequently cools rise to the weld bead.

Laser welding was originally proposed as an alternative to flash butt welding in order to improve welding reliability and reduce emissions into the air. The main advantages of the adoption of this technique are:

- Good level of penetration due to the high energy density;
- High welding speed;
- Small heat affected zone and heat diffusion;
- Good repeatability;
- More limited deformations;
- Weldability of a wide range of steel grades (mild , micro-alloyed and alloyed steels);
- Weldability of heterogeneous joints.

From a structural point of view, the welder is characterised by an input section and an output section which are symmetrical and constituted by the same main elements. A laser welding machine is shown in Figure 3.53 and the purposes of the main elements of the machine are summarised below:

- Lift roll: It supports the strip and allows the centering and locking. This roll is also necessary to ensure that the strip is transported through the machine without touching its parts.
- Cross roll: It prevents that the loop created does not push the strip out of position.
- Locking plan: It allows to modify the position of the strip edge during the welding process.
- Locking device: It is necessary to lock the strips edges in order to have a perfect alignment during the welding process.
- Laser head: It guides the laser beam during welding and the laser head pressure produces a force that is applied over the edges to be welded.
- Pre/post heater: Depending on the class and quality of the material, it is necessary to heat the weld area immediately before/after the welding of the strip.
- Pre/post heater: Depending on the steel grade, it is necessary to heat the weld area immediately before/after the welding of the strip.
- Leveling roll: Immediately after welding, it is necessary to press the still hot weld bead with this roll in order to reduce the thickness of the weld bead.
- Punch: In order to control the weld bead, the punch is used to make a hole near it.
- Evacuation waste: After cutting the edges of the strips, the produced scrap is transported using a conveyor belt into a container.



Source: [31, EUROFER 10-7-18 2018]

Figure 3.53: Schematic of a laser welding machine (side view and upper view)

Since it is not possible to assess the quality of a weld only by optical evaluation, the welder is also equipped with a supervision system (Quality control data system QCDS) that receives input information from sensors on a number of relevant parameters (e.g. gap, penetration).

Achieved environmental benefits

- Reduction of dust emissions compared to conventional welding techniques such as flash butt welding.
- Improved material efficiency because improved weldability and improved reliability of the welding itself. In addition, it has to be noticed that no additional input of metal is required for welding.

Environmental performance and operational data

No information provided.

Cross-media effects

None reported.

Technical considerations relevant to applicability

Generally, there are no technical restrictions to the applicability of this technique.

Economics

No information provided.

Driving force for implementation

- Improved reliability of the welding process.
- Improved behaviour of the welded part in the successive processes (pickling and rolling).
- Improved yield.

Example plants

- Ilva plant in Genova: 194 CR
- Ilva plant in Novi Ligure: 195 CR
- ArcelorMittal Liège and Florange

Reference literature

[31, EUROFER 10-7-18 2018].

3.4.1.2 Air extraction as close as possible to the source for emissions from decoiling and mechanical pre-descaling

Description

Emissions from decoiling and mechanical pre-descaling are collected, for example using hood or lip extraction. The extracted air is treated by a fabric filter.

Technical description

Iron oxide dust which may contain heavy metals (e.g. nickel and lead) is formed by stretching the strip during the decoiling operation and during mechanical pre-descaling before pickling.

Where emissions are significant, especially in the processing of high-alloy steel, the decoilers and the pre-descaling machines are equipped with suction hoods, which lead the air containing iron oxide dust directly to the fabric filters. The cleaned air is emitted via the chimney. The fabric filters are cleaned using backwashing with pressurised air. The iron oxide dust is collected at the bottom of the fabric filter using rotary valves. [25, EUROFER 2018]

Achieved environmental benefits

- Prevention of dust emissions in the surrounding workplace area.
- Reduction of dust emissions.
- Reduction of nickel and lead emissions.

Environmental performance and operational data

Table 3.9: Operational data for a dry dedusting system installed at the decoilers (Voestalpine cold rolling mill)

Suction capacity	40 000 m ³ /h
Number of tube filters	240
Rotary valves	2
Maximum filter loading	100 m ³ /m ² /h
Residual dust content	max. 5 mg/m ³
<i>Source: [25, EUROFER 2018]</i>	

Cross-media effects

- Additional consumption of energy.
- The filter dust requires disposal or pretreatment prior recycling.

Technical considerations relevant to applicability

Generally, there are no technical restrictions to the applicability of this technique.

Economics

Investment costs were reported to be EUR 280 000 for an exhaust system equipped with fabric filter (for a 3 Mt/yr plant). [[18, CITEPA 1994](#)]

Driving force for implementation

- Environmental legislation.
- Health and safety considerations.

Example plants

- Decoiling: 08 CR3, 102 CR2, 244 CR1.
- Mechanical predestaling: Widely used (e.g. 08 CR2, 26 CR2, 193 CR1, 193 CR2, 238 CR1,)

Reference literature

[[18, CITEPA 1994](#)], [[25, EUROFER 2018](#)].

3.4.1.3 Hydrochloric acid regeneration by spray roasting

Description

The pickling solutions are injected via spray nozzles in the pyrohydrolytic reactor at high temperature where they react with oxygen and water to form a highly valuable iron oxide solid product. The hydrochloric acid is recovered using an adiabatic column where rinse water from the pickling line is used as absorption water.

Technical description

See Section 8.6.5 for a technical description of the spray roasting regeneration process.

Achieved environmental benefits

- Reduced consumption of fresh acid (from 12–17.5 kg/t to 0.7–0.9 kg/t; HCl concentration 33 %).
- Reduced waste water volume and sludge.

Environmental performance and operational data

Table 3.10 presents data on consumption and material outputs associated with HCl spray roasting.

Table 3.10: Consumption, emission levels and material outputs for HCl spray roasting

Input / Consumption Level		
Spent acid	0.7 - 0.9	kg/t
Cooling water (in)	0.07 - 0.09	m ³ /t
Industrial + demineralised water	0.09 - 0.15	m ³ /t
Energy:		
Electrical energy	4 - 15	MJ/t
Caloric energy (natural gas)	102 - 119	MJ/t
Output / Emission Level		
	Specific Emission	
Solid by-product: Fe ₂ O ₃	5.1-5.4 (5.6 ArcelorMittal Ghent)	kg/t
Recycled acid (20 %)	23 - 40	kg/t
Cooling water (out)	0.07 - 0.09	m ³ /t
Waste gas	24 -38	m ³ /t
Waste water (discharge)	0.04 - 0.07	m ³ /t
<i>Source: [89, EUROFER, TG Cold Rolling 1998]</i>		

Table 3.11 presents a summary of the emissions data reported in the data collection for HCl spray roasting plants.

Table 3.11: Emissions to air from HCl spray roasting (combined data from cold rolling and hot rolling plants)

Substance	Concentrations reported over 3-year period - (mg/Nm ³)					Number of plants / number of measurements
	Average	Median	90 th percentile	Min.	Max.	
Dust	9.8	8.8	19.4	0.05	28.0	18 / 70
HCl	7.2	3.6	20.2	0.05	44.6	13 / 91
SO ₂	2.3	0.6	7.9	0.1	8.0	6 / 25
NO _x	115.3	120.0	179.4	16.9	229.6	15 / 53
<i>Source: [16, FMP TWG 2018]</i>						

Cross-media effects

- Additional consumption of energy and water.
- Generation of emissions to air (combustion product and acid), which have to be reduced by e.g. wet scrubbers.

Technical considerations relevant to applicability

Generally, there are no technical restrictions to the applicability of this technique.

Economics

Depending on site circumstances, the high acid consumption and amounts of waste acid generated and the savings generally obtained from regeneration may justify the investment in a regeneration plant.

The iron oxide produced has a commercial value and can be traded directly on the market. [25, EUROFER 2018]

Driving force for implementation

Reduced costs due to increased material efficiency.

Example plants

Used by a significant number of CR plants (See Figure 7.1).

Also used at several HRPO plants (e.g. 12 HR1; 37 HR1, 106 HR2).

Reference literature

[25, EUROFER 2018], [96, Kladnig 2008].

3.4.1.4 Hydrochloric acid regeneration by fluidised bed

Description

The spent pickle liquor is fed into a fluidised bed reactor, where it is thermally decomposed at high temperature in the presence of water vapour and oxygen into hydrochloric acid and iron oxide. Off-gases from the reactor are cooled and fed to an absorber, where HCl is absorbed by rinse liquor and fresh water.

Technical description

See Section 8.6.5 concerning the technical description of the fluidised bed regeneration process.

Achieved environmental benefits

- Reduced consumption of fresh acid.
- Reduced waste water volume and sludge.

Environmental performance and operational data

Table 3.12 presents a summary of the emissions data reported in the data collection for plants operating a fluidised bed reactor for HCl recovery.

Table 3.12: Emissions to air from HCl recovery plants using a fluidised bed reactor

Substance	Concentrations reported over 3-year period - (mg/Nm ³)				Number of plants / number of measurements
	Average	Median	Min.	Max.	
Dust	12.3	9.3	0.6	34.0	3 / 15
HCl	2.2	0.9	0.3	13.2	3 / 20
SO ₂	6.7	5.3	1.4	18.6	1 / 8
NOx	43.3	42.0	32.6	60.0	1 / 7

Source: [16, FMP TWG 2018]

Cross-media effects

Additional consumption of energy and water.

Technical considerations relevant to applicability

Generally, there are no technical restrictions to the applicability of this technique.

Economics

The economics of a modern pickling plant with the fluidised bed process involve the following factors:

- raw acid consumption;
- utilisation of rinse and scrubber water;
- production of clear, iron-free hydrochloric acid;
- production of iron oxide which can be used in different industries.

Generally, the capital costs of a pickling plant, including the fluidised bed process, are favourable compared with the operation costs and resulting benefits. Overall economics will vary from one installation to another, due to local differences in acid cost, waste pickle liquor regeneration cost and the cost involved in modernising existing facilities or constructing new facilities. [97, Rituper 1995]

Driving force for implementation

Reduced consumption of acid.

Example plants

Plants from the data collection: 179 CR1, 194 CR1, 195 CR lines 2 and 3.

Reference literature

[96, Kladnig 2008], [97, Rituper 1995].

3.4.1.5 Effluent-free HCl strip pickling plant**Description**

An effluent-free HCl strip pickling plant enables complete regeneration of the spent pickle liquor using a fluidised bed recovery process with complete recycling of the rinse water (e.g. no water emissions) and extremely low acid consumption.

Technical description

In an effluent-free HCl strip pickling plant, the spent pickle liquor is completely regenerated in a recovery system using a fluidised bed process. The pickle liquor recycled between the pickling tanks and regeneration unit results in nearly zero consumption apart from small evaporation losses. The rinse water is completely reused. This makes an effluent-free operation of the pickling plant possible. [97, Rituper 1995]

Since the fluidised bed process operates at approximately 850 °C, additional rinse and scrubber water from the pickle line can be utilised in the regeneration plant. In accordance with the energy balance of the venture scrubber, a certain amount of water is necessary for cooling the reactor off-gas by evaporation. [97, Rituper 1995]

The quantity of rinse and scrubber water, which can be utilised in the fluidised bed process, depends on the iron content of pickle liquor. An example of rinse water utilisation is shown in Figure 3.54. A portion of the rinse water is used for absorption, with the remainder directly added to the venturi scrubber. [97, Rituper 1995]

In the example shown in Figure 3.54, a total of 5 943 l/h of rinse water can be used for the absorption of HCl. Depending on the iron content of the pickle liquor, approximately 500 l/h of rinse water at 105 g/l Fe⁺⁺ and approximately 1 750 l/h of rinse water at 130 g/l Fe⁺⁺ can be used in addition.

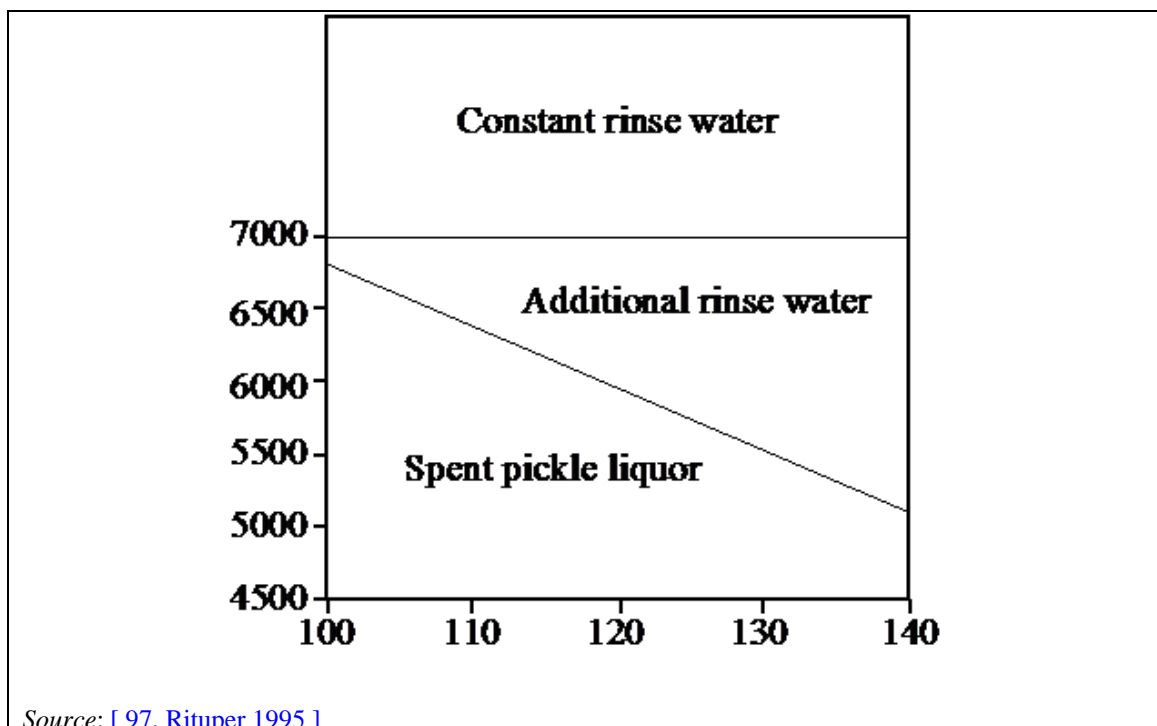


Figure 3.54: Dependence of rinse water utilisation on iron content

This example shows that an economical effluent-free pickling line operation can be achieved considering spent pickling liquor as well as rinse water quantities and concentrations.

Achieved environmental benefits

No water discharge/pollution.

Environmental performance and operational data

This process is capable of operating a completely closed, effluent-free pickling plant and has already been installed in several modern facilities. These facilities are operating with hydrochloric acid consumption of less than 0.2 kg acid/tonne of pickled material. One example of an effluent-free strip pickling line in operation is illustrated in Figure 3.55. [97, Rituper 1995]

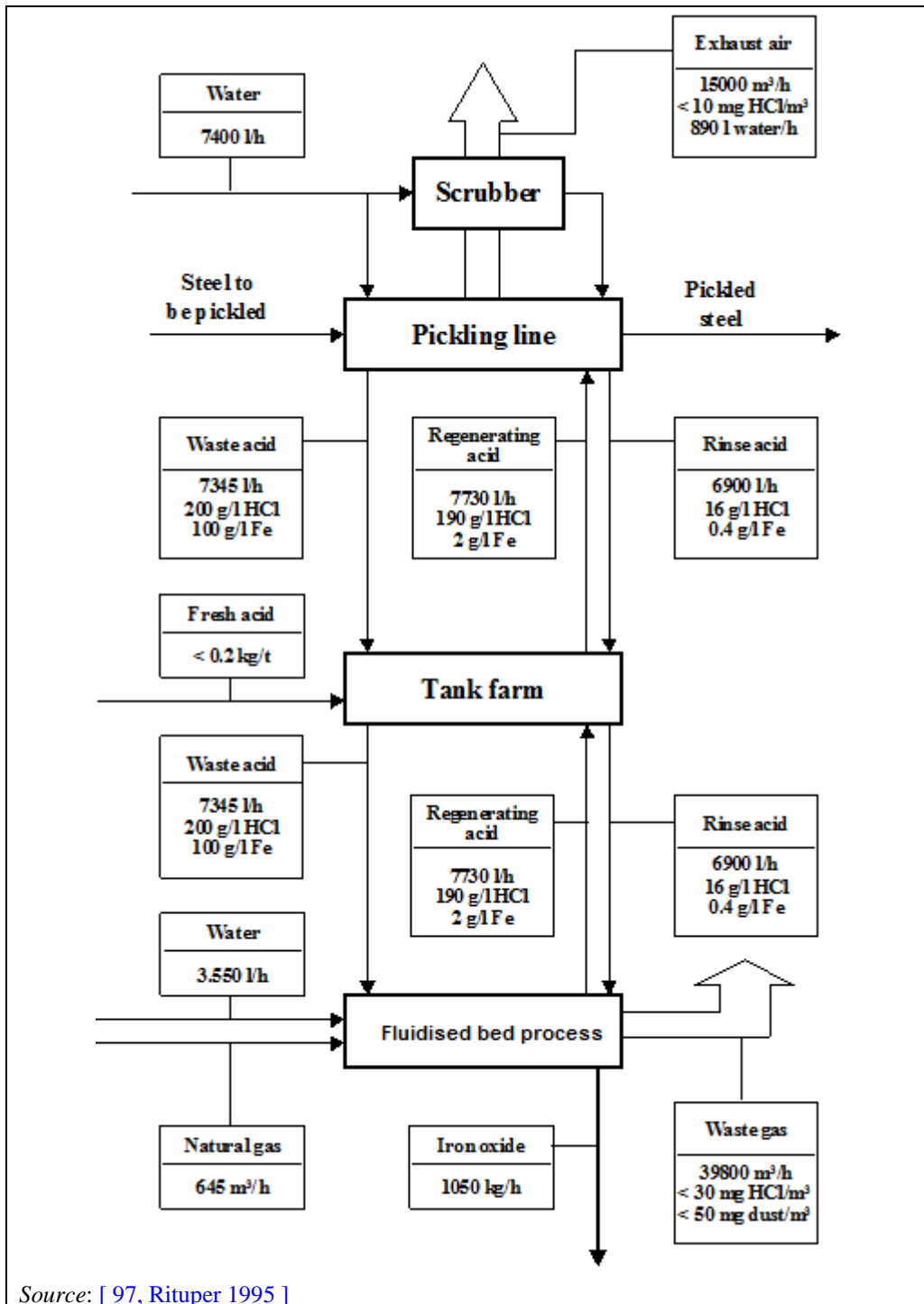


Figure 3.55: Example of effluent-free HCl pickling and acid regeneration

Cross-media effects

Additional consumption of energy and water.

Technical considerations relevant to applicability

Generally, there are no technical restrictions to the applicability of this technique.

Economics

Reduced production costs because of low acid consumption.

Driving force for implementation

- Environmental legislation.
- Savings in acid consumption.

Example plants

[97, Rituper 1995].

Reference literature

[97, Rituper 1995].

3.4.1.6 Sulphuric acid recovery by crystallisation**Description**

The ferrous sulphate accumulated in the acid is crystallised and removed as a ferrous sulphate heptahydrate material. The crystallisation is achieved using indirect cooling, a cyclone treatment or by decompression evaporation under vacuum.

Technical description

See Section 8.6.5 for the technical description of the sulphuric acid recovery process by crystallisation.

Achieved environmental benefits

- Reduced consumption of fresh acid.
- Reduced waste water volume and sludge.

Environmental performance and operational data

Table 3.13 and Table 3.14 present data on consumption and emissions associated with H₂SO₄ vacuum crystallisation.

Table 3.13: Consumption and outputs for H₂SO₄ vacuum crystallisation

Input / Consumption Level		
Spent acid	7 - 10	kg/t
Cooling water (in)	2 - 3.5	m ³ /t
Industrial + demineralised water	0.2 - 0.4	m ³ /t
Energy:		
Electrical energy	1 - 20	MJ/t
Caloric energy	100 - 200	MJ/t
Output / Emission Level		
	Specific Emission	
Solid by-product: Fe-sulphate	26 - 30	kg/t
Recycled acid (20 %)	0 - 10	kg/t
Cooling water (out)	2 - 3.5	m ³ /t
Waste gas	70 - 90	m ³ /t
Waste water (discharge)	0.2 - 0.4	m ³ /t
Source: [89, EUROFER, TG Cold Rolling 1998]		

Table 3.14: Emissions to air from H₂SO₄ vacuum crystallisation

	Concentration [mg/Nm ³]	Specific Emission [g/t product]	Reduction rate ¹ [%]	Method of analysis
SO ₂	8 – 20	0.5 – 1.5	> 95	Infrared
H ₂ SO ₄	5 – 10	0.3 – 0.6	> 95	Titration

Source: [89, EUROFER, TG Cold Rolling 1998]

¹ Reduction rate based on mass flow of constituent before/after abatement measure

Cross-media effects

- Increased energy consumption.
- Emissions to air from recovery.

Technical considerations relevant to applicability

Generally, there are no technical restrictions to the applicability of this technique.

Economics

No information provided.

Driving force for implementation

Reduced consumption of acid.

Example plants

No plants reported the use of this acid recovery technique in the 2018 FMP data collection.

Reference literature

[89, EUROFER, TG Cold Rolling 1998].

3.4.1.7 Mixed acid (HNO₃ and HF) regeneration by spray roasting

Description

The pickling solutions are injected via spray nozzles in the pyrohydrolytic reactor at high temperature where they react with oxygen and water to form a highly valuable iron oxide solid product. The acid is recovered using a two-stage isothermal adsorption unit followed by a selective catalytic reduction unit to reduce NO_x emissions.

Technical description

See Section 8.6.5 for a technical description of the spray roasting regeneration process.

Achieved environmental benefits

- Reduction in fresh acid consumption (from 2.5–7 kg/t HF and 3–10 kg/t HNO₃ down to 0.8–1.2 kg/t HF), reduction of new acid to be produced (supplier). [98, Karner 1999]
- Reduction of neutralisation sludge. [98, Karner 1999]

Environmental performance and operational data

Table 3.15 presents data on consumption and outputs of mixed acid regeneration by spray roasting.

Table 3.15: Consumption and emission outputs of mixed acid regeneration by spray roasting

Input/Consumption Level		
Spent acid	25 - 100	kg/t
Cooling water (in)	1.5 - 9	m ³ /t
Urea (for DeNO _x)	0.4 - 1	kg/t
Caustic soda		
Energy:		
Electrical energy	5 - 20	MJ/t
Caloric energy (natural gas)	60 - 230	MJ/t
Output/Emission Level		
Solid by-product: mixed oxide	1.7 - 5	kg/t
Recycled acid (HF 6 %, HNO ₃ 10 %)	26 - 108	kg/t
Cooling water (out)	1.5 - 9	m ³ /t
Waste gas:	25 - 100	m ³ /t
Waste water	0.003 - 0.01	m ³ /t
<i>Source: [98, Karner 1999], example Pyromars</i>		

Table 3.16 presents a summary of the emissions data reported in the data collection for plants using the spray roasting for mixed acid recovery.

Table 3.16: Emissions of NO_x to air from mixed acid recovery plants using spray roasting

Substance	Concentrations reported over 3-year period - (mg/Nm ³)				Number of plants / number of measurements
	Average	Median	Min.	Max.	
NO _x	140.3	119.3	93.8	218.2	2 / 6
<i>Source: [16, FMP TWG 2018]</i>					

Cross-media effects

- Consumption of energy and chemicals.
- Generation of air emissions which have to be reduced/controlled.
- Generation of waste water which has to be treated.
- Generation of usable by-product mixed oxide. [98, Karner 1999]

Technical considerations relevant to applicability

Generally, there are no technical restrictions to the applicability of this technique.

Economics

The produced iron oxide has a commercial value and can be traded directly on the market. [25, EUROFER 2018], [96, Kladnig 2008]

The economic advantage calculated for a steelworks producing 350 000 tonnes of hot rolled mild steel is estimated to be EUR 800 000 per year in chemicals and work. [96, Kladnig 2008]

Driving force for implementation

Besides the environmental benefits of reducing the overall acid consumption and waste water emissions, the spray roasting technology allows the recovery of iron oxide which can be recycled in the smelting process or commercially traded on the market. [25, EUROFER 2018]

Example plants

Example plants from the data collection: 88 CR1 and 238 CR2 from. See also Figure 7.4.

Reference literature

[25, EUROFER 2018], [96, Kladnig 2008], [98, Karner 1999].

3.4.1.8 Mixed acid (HNO₃ and HF) recovery by ion exchange**Description**

Pickling solutions are treated using a side-stream acid purification unit which utilises filters and an ion exchange resin to selectively adsorb metallic salts from the pickling acid. Once the purification unit is saturated, the free acid is desorbed by backwashing with water and recycled to the pickling process.

Technical description

In the mixed acid pickling of stainless steel, metals are continuously dissolved in the pickling solution. When the dissolved metals reach high concentrations, technical problems such as salt precipitation with formation of sludges start to occur. To prevent this, the pickling liquor is treated using special resins which have the ability to separate the dissolved metals (e.g. iron, nickel, chrome and others) from the free pickling acid. Once the purification unit is saturated, the free acid is desorbed by a fresh water stream and recycled to the pickling process. [25, EUROFER 2018], [99, Agrawal et al. 2009]

Achieved environmental benefits

Reduced acid consumption.

Environmental performance and operational data

Table 3.17: Consumption and emission levels for mixed acid recovery by ion exchange

Input / Consumption Level		
Spent mixed acid	0.05 - 0.2	m ³ /t
Water	0.05 - 0.2	m ³ /t
Energy:		
Electrical energy	2 - 5	MJ/t
Output / Emission Level		
Specific Emission	0.05 - 0.2 m ³ /t	
Recovered mixed acid		
Free HF recovery rate:	75 - 85 %	
Free HNO ₃ recovery rate:	80 - 85 %	
Metals removal rate:	50 - 55 %	
Metal containing weak acid solution	0.05 - 0.2	m ³ /t
Source: [89, EUROFER, TG Cold Rolling 1998]		

Cross-media effects

Increased energy consumption.

Technical considerations relevant to applicability

Generally applicable at stainless steel plants. [25, EUROFER 2018]

Economics

Savings made due to reduced consumption of acids. [25, EUROFER 2018]

Driving force for implementation

Reduction of acid consumption.

Example plants

Outokumpu Germany Krefeld.

Reference literature

[25, EUROFER 2018], [99, Agrawal et al. 2009].

3.4.1.9 Mixed acid (HNO₃ and HF) recovery by diffusion dialysis**Description**

A positively charged membrane is used to separate the spent pickle liquor to be regenerated from fresh water. The membrane allows diffusion of the acid to the fresh water side while the metal salts remain in the spent liquor side, resulting in high recovery of the acid.

Technical description

See Section 8.6.5 concerning the technical description of the mixed acid recovery process by diffusion dialysis.

Achieved environmental benefits

Reduction of waste and fresh acid consumption.

Environmental performance and operational data

A diffusion dialysis plant was installed at a Swedish Plant in 1989 for regeneration of stainless steel pickling acid with a capacity of 300 l/h. [100, Deutsche 1993]. The recycling rate of free acid is about 80–85 %. The diffusion dialysis plant is simple to operate and requires little supervision. Although the process is not entirely selective, less than 5 % of metal salts are present in the regenerated mixed acid solution after treatment. [101, Dahlgren 2010]

A pretreatment of the spent pickling liquor is required to prevent the surface of the membrane from becoming clogged. [101, Dahlgren 2010]

Cross-media effects

Increased energy consumption.

Technical considerations relevant to applicability

Generally, there are no technical restrictions to the applicability of this technique.

Economics

The investment cost for a diffusion dialysis plant with a capacity of 1 m³/h mixed acid is about SEK 1.5 million. [101, Dahlgren 2010]

Driving force for implementation

Regeneration of mixed acid.

Example plants

Outokumpu Avesta (Sweden).

Reference literature

[100, Deutsche 1993], [101, Dahlgren 2010], [102, Luo et al. 2011].

3.4.1.10 Mixed acid (HNO₃ and HF) recovery by evaporation

Description

In a vacuum evaporator, the mixed acids are driven off and condensed prior to being recycled to the main pickling tank whereas sulphate metal salts are formed, precipitated in a crystalliser as slurry and neutralised to form hydroxide sludge.

Technical description

See Section 8.6.5 concerning the technical description of the mixed acid recovery process by evaporation.

Achieved environmental benefits

- Reduction of fresh acid consumption by recycling both free and bounded HNO₃ and HF.
- Significant reduction of nitrates in waste waters.
- No dust emissions. [\[103, FI, TWG member 2000 \]](#)

Environmental performance and operational data

In Outokumpu (Tornio, Finland, plant 158 CR in the FMP data collection), three evaporation regeneration units have been installed for mixed acid regeneration. The recycling rate for HNO₃ is 98 % and 99 % for HF. [\[25, EUROFER 2018 \]](#), [\[101, Dahlgren 2010 \]](#)

Table 3.18: Consumption and emission levels for mixed acid recovery by evaporation

Input/Consumption Level	
Spent acid	15 – 30 litres / t
H ₂ SO ₄ (95 %)	4.0 – 6.0 kg / t
Cooling water	3.8 – 5.8 kg / t
Energy:	
Electricity	2.3 – 3.5 MJ / t
Steam	16 – 24 kg / t
Propane	3.2 – 4.8 MJ / t
Output/Emission Level	
Cooling water	3.8 – 5.8 kg / t
Recycled acid:	14 – 20 litres / t
130 g/l HNO ₃	
55 g/l HF	
Metal sulphate:	5.0 – 7.6 kg / t
Fe	0.6 – 0.8 kg / t
Cr	0.09 – 0.13 kg / t
Ni	0.08 – 0.12 kg / t
SO ₄	1.9 – 2.9 kg / t
H ₂ SO ₄	1.7 – 2.5 kg / t
Waste gas:	
Dust	None
HF	< 2 mg / l
NO ₂	< 100 mg / l
The data above is based on measurements during plant operation.	
Source: [103, FI, TWG member 2000]	

Table 3.19: Emissions to air from mixed acid recovery plants using evaporation recovery

Substance	Concentrations reported over 3-year period - (mg/Nm ³)				Number of plants / number of measurements
	Average	Median	Min.	Max.	
Dust	7.6	8.0	6.0	9.0	1 / 5
SO ₂	0.5	0.4	0.2	1.0	2 / 3
NO _x	37.5	-	8.9	66.0	1 / 2
<i>Source:</i> [16, FMP TWG 2018]					

Cross-media effects

- Consumption of energy to evaporate acids. [25, EUROFER 2018]
- Generation of metal sulphates, which can be neutralised to metal hydroxides. [103, FI, TWG member 2000]
- HF and NO_x emissions. [25, EUROFER 2018]

Technical considerations relevant to applicability

Generally, there are no technical restrictions to the applicability of this technique.

Economics

- Savings due to reduced consumption of acids.
- Easy to maintain constant composition of pickling acids.
- No need for acid neutralisation. [103, FI, TWG member 2000]

Driving force for implementation

Total regeneration of mixed pickling acids. [103, FI, TWG member 2000]

Example plants

- Outokumpu Tornio (Finland) : 158 CR
 - Regeneration plant 1, capacity 1.5 m³/h, start year 1984.
 - Regeneration plant 1, capacity 3.0 m³/h, start year 1997.
 - Regeneration plant 3, capacity 6.0 m³/h, start year 2003.
- ArcelorMittal Galati (Roumania): 111 CR1

Reference literature

[25, EUROFER 2018], [101, Dahlgren 2010], [103, FI, TWG member 2000], [205, Nyman et al. 1986].

3.4.1.11 Magnetic pumps (low-alloy and alloy steel)**Description**

Magnetic drive pumps are employed instead of mechanical pumps to reduce water consumption and prevent leakages of fluids.

Technical description

Mechanical pumps need a constant gland water flow on the mechanical seals. Substitution of mechanical by magnetic pumps reduces the water needs. In addition, magnetic drive pumps are sealless pumps which do not use packing or mechanical seals to isolate the process fluid. Accordingly, magnetic drive pumps prevent leakages of fluids.

Achieved environmental benefits

- Reduction of water consumption.
- Prevention of leakages of fluids.

Environmental performance and operational data

No information provided.

Cross-media effects

None.

Technical considerations relevant to applicability

Generally, there are no technical restrictions to the applicability of this technique.

Economics

No information provided.

Driving force for implementation

Reduced water consumption.

Example plants

Widely used.

Reference literature

No reference literature provided.

3.4.1.12 Treatment of acidic waste water

Description

Where acidic water blowdown from the system cannot be avoided, acidic waste water is neutralised and metals are precipitated and separated by sedimentation. The metal sludge is dewatered in filter presses and disposed of.

Technical description

Acidic waste water from rinsing and from fume absorbers of the pickling tank exhaust system, if it cannot be used in the pickling tanks, and the waste water from flushing (plant cleaning) require treatment prior to discharge. The waste water is neutralised (e.g. with alkaline waste waters from other plant operations), dissolved metal ions are transformed into hydroxides or sparingly soluble salts and subsequently eliminated by sedimentation, in many cases by adding flocculants. The precipitated metal sludge is dewatered in filter presses and disposed of.

Achieved environmental benefits

Reduction of volume and contaminant load to water.

Environmental performance and operational data

Table 3.20: Pollutant concentrations at cold rolling plants employing neutralisation followed by sedimentation for treatment of acidic waste water.

Substance	Concentrations reported over 3-year period			Reference plants
	Average	Min.	Max.	
Total suspended solids (mg/l)	3.9	1.3	30.0	110 CR2, 88 CR, 244 CR
Fe (mg/l)	0.2	0.03	4.2	110 CR2, 225 CR, 244 CR
Zn (mg/l)	0.05	0.02	0.24	225 CR, 88 CR, 110 CR2
Ni (mg/l)	0.14	0.02	0.92	110 CR2, 88 CR
Pb (µg/l)	7.7	3.0	21.0	110 CR2
Cr (mg/l)	0.08	0.01	0.46	225 CR, 88 CR, 110 CR2
Cd (µg/l)	5.0	5.0	5.0	110 CR2
HOI (mg/l)	0.23	0.10	2.20	244 CR

Source: [16, FMP TWG 2018]

Cross-media effects

- Generation of a large quantity of sludge.
- The sludge, mainly consisting of iron hydroxide and water, can be recycled for iron production as long as it is not contaminated by unacceptable metals (e.g. zinc) or by other constituents. Care should be taken to avoid mixing of waste water streams or sludges which can make recycling difficult.
- Neutralisation can also create large amounts of neutral salts (e.g. NaCl, CaCl₂, Na₂SO₄, CaSO₄), most of which are very soluble in water and are discharged with the treated water. Removal is only possible by very special, and in most cases uneconomical, treatment (reverse osmosis, electrodialysis or evaporation followed by ion exchange and concentrate evaporation with salt drying). Even if these salts are removed, their mixed composition limits reuse and disposal to landfill may be restricted by their solubility.

Technical considerations relevant to applicability

Generally, there are no technical restrictions to the applicability of this technique.

Economics

No information provided.

Driving force for implementation

Environmental legislation.

Example plants

Plants from the data collection: 88 CR, 110 CR2, 225 CR, 244 CR.

Reference literature

[16, FMP TWG 2018].

3.4.1.13 Three-acid pickling for stainless steel

Description

In the three-acid pickling technique, nitric acid is partially substituted with sulphuric acid for pickling stainless steel products, reducing the consumption of nitric acid.

Technical description

Conventional pickling in stainless steel production is usually performed using mixed acid (HF/HNO₃). In the three-acid pickling technique, the nitric acid is partially substituted with sulphuric acid and used in combination with HF. The price of nitric acid is higher than the price of sulphuric acid; accordingly, substantial economic savings can be made with this technique. In addition, three-acid pickling results in a significant reduction in waste water emissions of nitrates.

In conventional mixed acid pickling, HNO₃ concentrations typically ranges from 180 g/l to 380 g/l while HF concentrations ranges from 10 g/l to 40 g/l. [[104, Dustou et al. 2017](#)]

In three-acid pickling, the nitric acid concentrations are reduced to 40–90 g/l depending on the type of product and H₂SO₄ concentrations are within the range of 50–160 g/l. [[31, EUROFER 10-7-18 2018](#)]

In stainless steel pickling plants, the acid regeneration process leads to emissions to water of nitrates, particularly during the neutralisation process. With three-acid pickling, these emissions can be reduced since the quantities of nitric acid employed are substantially reduced. [[31, EUROFER 10-7-18 2018](#)]

Achieved environmental benefits

- Significant reduction of nitrate emissions.
- Reduction of nitric acid consumption.

Environmental performance and operational data

The three-acid pickling technique is currently implemented at Outokumpu Tornio (Finland). The use of this technique is restricted to pickling plants employing an evaporation process for regeneration of the acid because the presence of sulphuric acid would cause issues in other types of acid regeneration processes (See Section 8.6.5). The pickling liquor is first mixed with sulphuric acid before entering the evaporator. The evaporation takes place under vacuum at 80 °C and at a pressure of 5 kPa which vaporises HF and HNO₃. These are then condensed and recirculated back to the pickling bath. The slurry is led to a crystallisation tank for precipitation of different metal sulphates. After thickening, the metal sulphate slurry is separated from the excess sulphuric acid, which is recirculated to the evaporator. [[101, Dahlgren 2010](#)]

Reductions of nitrate emissions of between 25 % and 70 % can be achieved depending on the level of nitric acid substitution. Metals in the pickling bath are precipitated mainly as sulphates instead of fluorides, resulting also in a reduction of about 10 % in HF consumption. [[31, EUROFER 10-7-18 2018](#)]

The acid neutralisation process is more difficult to control when using sulphuric acid, resulting sometimes in difficulties to maintain the concentrations of the suspended solids in waste water emissions from the neutralisation plant at < 20 mg/L. [[31, EUROFER 10-7-18 2018](#)]

Cross-media effects

None.

Technical considerations relevant to applicability

- The use of this technique is restricted to stainless steel pickling plants employing an evaporation process for regeneration of the mixed acid because the presence of sulphuric acid causes issues for other types of acid regeneration processes.
- In some cases, three-acid pickling might not be suitable for the production of special steel grades.

Economics

The price of H₂SO₄ is lower than the price of HNO₃, making the three-acid pickling technique financially viable.

Driving force for implementation

Reduction of nitrate waste water emissions.

Example plants

Outokumpu Tornio (Finland): 158 CR.

Reference literature

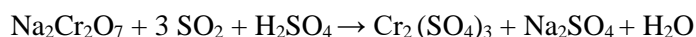
[31, EUROFER 10-7-18 2018], [101, Dahlgren 2010], [104, Dustou et al. 2017].

3.4.1.14 Chemical reduction of hexavalent Cr(VI) with sulphur dioxide**Description**

The rinsing waters and solids from the electrolytic prepickling baths which contain Cr(VI) generated during the electrolytic prepickling of high-alloy steel are treated in acidic conditions to reduce their Cr(VI) concentrations using sulphur dioxide as the reducing agent. After the chemical reduction process, the solution is fed into the neutralisation step of the waste water treatment plant together with acidic rinsing waters from the mixed acid pickling.

Technical description

The suspensions to be treated are first stored in a mixing tank to level concentration differences of different feed streams. Sulphuric acid is fed into the mixing tank to lower the pH of the solution. Indeed, a low pH value increases the rate of the Cr(VI) reduction reaction. Furthermore, the chemical reaction also consumes sulphuric acid so it must be fed into the mixing tank before the actual reduction reaction takes place. After mixing, the solution is pumped into a feeding tank. It is also possible to control the pH value of the solution at this point. From the feeding tank, the solution is pumped into a first reduction reactor that overflows into a second reduction reactor. In total, two reactors in series are used and SO₂ is fed into both reactors. The reduction reaction of Cr(VI) is as follows:



The reduction of Cr(VI) is monitored through pH and redox-potential values. An automated analyser continuously analyses the Cr(VI) concentration in the feeding tank and adjusts the rate of sulphur dioxide addition accordingly. The controller also uses the feed rate and the redox-potential value as inputs for the calculation of required SO₂ addition. After the reduction process, the solution is fed into the neutralisation process together with acidic rinsing waters from the mixed acid pickling. [31, EUROFER 10-7-18 2018], [42, Lantz et al. 2008]

An alternative is to reduce Cr(VI) with NaHSO₃ in acidic conditions using spent acids (e.g. spent HCl) as acidifiers.

Achieved environmental benefits

Reduction of Cr(VI) emissions to water in stainless steel pickling plants.

Environmental performance and operational data

Cr(VI) concentrations < 0.1 mg/l can be achieved.

Cross-media effects

The use of SO₂ as a reducing chemical requires special safety considerations in the workplace. [[31, EUROFER 10-7-18 2018](#)]

Technical considerations relevant to applicability

Generally, there are no technical restrictions to the applicability of this technique.

Economics

Sulphur dioxide is a more effective reducing agent than the more widely used sodium metabisulphate (Na₂S₂O₅). As a result, the use of sulphur dioxide enables the use of smaller reactor sizes and decreases the investment costs. [[42, Lantz et al. 2008](#)]

Driving force for implementation

Minimisation of Cr(VI) emissions to water.

Example plants

Outokumpu Tornio.

Reference literature

[[31, EUROFER 10-7-18 2018](#)], [[42, Lantz et al. 2008](#)].

3.4.2 Rolling

3.4.2.1 Continuous rolling for low-alloy and alloy steel

Description

Continuous rolling (e.g. using tandem mills) is employed instead of conventional discontinuous rolling (e.g. using reversing mills), allowing for stable feed and less frequent start-ups and shutdowns.

Technical description

Continuous rolling is employed in the production of low-alloy and alloy steel as it presents many advantages compared to discontinuous rolling (e.g. stable feed, reduced start-ups and shut-downs, improvement in quality and yield).

Discontinuous rolling using, for example, a conventional reversing mill offers high process flexibility and enables a number of variations in the product mix. Reversing mills can be easily stopped and restarted, meaning that rolling parameters can be quickly changed for each coil. Reversing mills are particularly suitable for the production of small batches of different product types. However, reversing mills have drawbacks such as the need for high-power coilers and uncoilers and time-consuming work necessary for removing coils which results in higher energy consumption and a decrease in the overall productivity of the rolling mill. On the other hand, continuous rolling using a tandem mill for instance presents significant advantages including an important reduction in energy consumption because of the use of less powerful coilers/uncoilers but also a significant increase in productivity since there is no need to interrupt the rolling process to change coils.

Achieved environmental benefits

- Reduction in oil consumption.
- Reduction of electricity consumption.

Environmental performance and operational data

- Improvement of the material yield due to the better control of gauge for coil ends.
- Improvement on quality yield.
- Reduction in roll change frequencies.

Cross-media effects

None.

Technical considerations relevant to applicability

- Only applicable to new plants and major plant upgrades.
- Applicability may be restricted due to product specifications.

Economics

No information provided.

Driving force for implementation

Improved quality and increased yield.

Example plants

- Reversing mills: 88 CR2, 88 CR3, 116 CR1, 144 CR2, 144 CR3, 158 CR1, 225 CR1.
- Tandem mills: 110 CR1 line 2, 128 CR2, 249 CR1.

Reference literature

[\[16, FMP TWG 2018 \]](#).

3.4.2.2 Pickling plant coupled with the tandem mill**Description**

Pickling lines are coupled with a tandem cold rolling mill to increase the production throughput and minimise the amounts of defects (e.g. scrap).

Technical description

Coupling pickling lines with tandem cold rolling mills enables high rolling yield and efficiency, a significant reduction of the processing time and the possibility to achieve narrower thickness tolerances. Also, coupled pickling lines and tandem cold rolling mills minimise the amounts of defects (e.g. scrap). [\[105, Bos et al. 2006 \]](#)

Achieved environmental benefits

Reduced scrap (minimisation of defects).

Environmental performance and operational data

No information provided.

Cross-media effects

None.

Technical considerations relevant to applicability

Only applicable to new plants and major plant upgrades.

Economics

This technique reduces operational processing costs (labour and maintenance costs).

Driving force for implementation

Reduced processing time, minimisation of defects, increased yield.

Example plants

Plants from the data collection: 08 CR, 37 CR, 102 CR, 122 CR, 130-CR1, 179 CR, 180 CR1, 193 CR, 194 CR, 195 CR.

Reference literature

[\[16, FMP TWG 2018 \]](#), [\[105, Bos et al. 2006 \]](#).

3.4.2.3 Optimal choice of rolling oil and emulsion system

Description

Rolling oil and emulsion systems are carefully selected to provide the optimum performance for a given process and product. Relevant characteristics to be considered are, for example:

- good lubrication;
- potential for easy separation of contaminants;
- stability of the emulsion and dispersion of the oil in the emulsion;
- non-degradation of the oil over a long idling time.

Technical description

In cold rolling, the proper choice of a tandem or reversing mill oil/emulsion is important for quality reasons (lubricant effect in the roll gap, good distillation properties, easy removal in degreasing lines). Besides that, to limit the oil consumption, a tandem mill oil must satisfy a number of performance criteria:

- Good lubrication characteristics to allow a decrease in the oil consumption and reduced friction between rolls and strip. [[25, EUROFER 2018](#)]
- An easy separation of contamination caused by accidental leakages from the hydraulic system or from the Morgoil roller bearings is necessary. If separation is not possible, a partial or a complete renewal of the emulsion is necessary.
- The actual process parameters (cold reduction, gauge, rolling forces, speed, roughness) and the available emulsion preparation station determine the requirements on the stability of the emulsion and on the dispersion of the oil in the emulsion.
- The quality of the oil has to remain unaffected by longer periods of line stop conditions (stability of the emulsion, formation of bacteria) in order to avoid a need for the premature disposal of the emulsion.
- Supplier and user are generally developing together the rolling oil/emulsion system tailored to the specific mill conditions. [[25, EUROFER 2018](#)]
- Incoming hot strip which is pickled and oiled should be adapted to the emulsion system. [[25, EUROFER 2018](#)]

Achieved environmental benefits

- Reduction in oil consumption.
- Reduced disposal of waste emulsion.

Environmental performance and operational data

No information provided.

Cross-media effects

None.

Technical considerations relevant to applicability

Generally, there are no technical restrictions to the applicability of this technique.

Economics

No information provided.

Driving force for implementation

Material efficiency.

Example plants

Widely used.

Reference literature

[[25, EUROFER 2018](#)]

3.4.2.4 Reduction of the rolling friction**Description**

Rolling oils are carefully selected. Pure oil and/or emulsion systems are used to reduce the friction between the working rolls and the feedstock and to ensure minimal oil consumption.

Technical description

Rolling oils are carefully selected to provide optimum performance for rolling (See Section 3.4.2.3). Rolling oils are supplied to the roll gap via nozzles in order to reduce the friction between material and roll, to lower the drive power requirements, to decrease rolling forces and to improve the surface quality of rolled material.

Achieved environmental benefits

- Reduction in oil consumption.
- Reduced disposal of waste emulsion.
- Reduction in energy consumption by optimising friction. [[25, EUROFER 2018](#)]

Environmental performance and operational data

No information provided.

Cross-media effects

Contamination of water system with rolling oils.

Technical considerations relevant to applicability

Generally, there are no technical restrictions to the applicability of this technique.

Economics

No information provided.

Driving force for implementation

Material and energy efficiency.

Example plants

Widely used.

Reference literature

[[16, FMP TWG 2018](#)], [[25, EUROFER 2018](#)].

3.4.2.5 Monitoring and adjustment of the rolling emulsion quality**Description**

Important characteristics of the rolling emulsion (e.g. oil concentration, pH, emulsion droplet size, saponification index, acid concentration, concentration of iron fines, concentration of bacteria) are monitored regularly or continuously to detect anomalies in the emulsion quality and take corrective action, if needed.

Technical description

The quality of the emulsion can be downgraded by a lot of accidents, which are difficult to monitor: carry-over of acid from the pickling line, contamination from the emulsion cooling water, contamination with hydraulic or Morgoil oil, destruction of the emulsion properties by

bacteria, or concentration of iron fines. These accidents very often result in the need for a partial or a complete renewal of the tandem emulsion.

A regular or, if possible, continuous measurement of the important emulsion characteristics (oil concentration, pH, saponification index, acid concentration, concentration of possible pollutants, concentration of iron fines droplet size, bacteria population, etc.) offers the possibility to detect and to remedy anomalies in the emulsion quality. [25, EUROFER 2018]

In addition, the measurements generate data which allow additions of oil and water to compensate the drag-out and keep the parameters as constant as possible. [25, EUROFER 2018]

Achieved environmental benefits

- Reduction in oil/emulsion consumption.
- Reduction of waste emulsion to be treated and disposed of.

Environmental performance and operational data

No information provided.

Cross-media effects

None.

Technical considerations relevant to applicability

Generally, there are no technical restrictions to the applicability of this technique.

Economics

Cost reduction and increased yield. [25, EUROFER 2018]

Driving force for implementation

- Reduction of waste emulsion through long lifetime. [25, EUROFER 2018]
- Reduction of oil use. [25, EUROFER 2018]
- Cost reduction through long lifetime. [25, EUROFER 2018]

Example plants

Widely used.

Reference literature

[16, FMP TWG 2018], [25, EUROFER 2018].

3.4.2.6 Prevention of contamination of the rolling emulsion

Description

Contamination of the rolling emulsion is prevented by techniques such as:

- regular control and preventive maintenance of the hydraulic system and the emulsion circulation system;
- reducing bacterial growth in the rolling emulsion system by regular cleaning and/or operating at low temperatures.

Technical description

In the cold rolling of carbon steel, it is very important to protect the rolling emulsion from any sources of pollution. [25, EUROFER 2018]

Contamination of the rolling emulsion can occur from different sources including:

- leakages of hydraulic oil or Morgoil oil;
- incompatible oil from oiled hot strip as well as acid residues from pickling;
- cleaning system in the circulation with filters and separators not working correctly;
- deposits and settlements in the piping and tanks as well as deposits from the mill stands;
- growth of bacterial population;
- contaminated water for emulsion set-up / water addition.

Preventive maintenance of the entire system helps to extend the lifetime of the emulsion as does regular cleaning of the roll stands: [\[25, EUROFER 2018 \]](#)

- Regular control of seals and piping helps to prevent leakages and contamination of the rolling emulsion with hydraulic oil or Morgoil oil. Preventive maintenance where seals and piping are changed on a regular basis is not unusual.
- Make the incoming oiled hot strip as compatible as possible and keep acid level in the rinse of the pickling under control.
- Regular maintenance of the circulation system with the filters, magnetic separator for proper functioning.
- Regular cleaning of the tanks, piping and mill stands to prevent bacterial growth.
- Beside the use of fungicides, a regular heat treatment kills bacteria. Running the emulsion with low temperatures and heat treatment can keep bacterial growth under control without the need to use fungicides.
- Fresh deionised set-up water prevents unexpected contamination.

Achieved environmental benefits

- Reduced emulsion consumption.
- Reduced waste water treatment and discharge.

Environmental performance and operational data

No information provided.

Cross-media effects

None.

Technical considerations relevant to applicability

Generally, there are no technical restrictions to the applicability of this technique.

Economics

No information provided.

Driving force for implementation

Long lifetime of the emulsion without unexpected disposal. [\[25, EUROFER 2018 \]](#)

Example plants

Widely used.

Reference literature

[\[16, FMP TWG 2018 \]](#), [\[25, EUROFER 2018 \]](#).

3.4.2.7 Minimisation of oil/rolling emulsion consumption

Description

The consumption of oil/rolling emulsion is minimised by using techniques such as:

- limiting the oil concentration to the minimum required for lubrication;
- limiting carry-over of emulsion from the previous stands (e.g. by separating the emulsion cellars, shielding of the mill stands);
- using air knives combined with edge suction to reduce the residual emulsion and oil on the strip.

Technical description

The residual oil concentration left on the strip leaving the mill, which is responsible for the major part of the oil consumption, is a function of the oil concentration in the last stand in tandem mills. Therefore, oil concentration in the last stand should be limited to the minimum required for lubrication. In addition, the carry-over of emulsion from the previous stands, where the oil concentration is higher, should be lower than the minimal working concentration. The possible measures (e.g. separating the emulsion cellars, shielding of the mill stands) are specific for each installation. An efficient working air knife combined with edge suction reduces the residual oil/emulsion on the strip leaving the mill. [\[25, EUROFER 2018 \]](#)

Achieved environmental benefits

Reduction of oil consumption.

Environmental performance and operational data

No information provided.

Cross-media effects

None.

Technical considerations relevant to applicability

Generally, there are no technical restrictions to the applicability of this technique.

Economics

No information provided.

Driving force for implementation

Reduction of oil use.

Example plants

Widely used.

Reference literature

[\[16, FMP TWG 2018 \]](#), [\[25, EUROFER 2018 \]](#).

3.4.2.8 Cleaning and reuse of the rolling emulsion

Description

Particulate matter (e.g. dust, steel slivers and scale) contaminating the rolling emulsion is removed in a cleaning circuit (usually based on sedimentation combined with filtration and/or magnetic separation) in order to maintain the emulsion quality and the treated rolling emulsion is reused. The degree of reuse is limited by the content of impurities in the emulsion.

Technical description

In cold rolling, the lubricant plays an essential role for reducing the friction at the strip/work roll contact field, reducing the work roll wear; and achieving a good final strip surface quality. Oil-

in-water emulsions are widely used due to their good characteristics as lubricants and coolants. They provide both good lubricity and cooling properties in high-speed rolling conditions.

The strip surface defect is a key issue in the rolling process. A poor strip surface quality after cold rolling may have a significant impact on the downstream processes such as annealing, galvanising and painting. The effect of the lubricating property of emulsion is therefore essential in the mechanism of surface defect evolution in rolling.

General surface defects of cold rolled strips are watermark defects, black spot defects, heat scratches and corrosion defects. Indentations and pimples can also be caused by surface defects of the work roll.

The characteristics and quality of the emulsion have a strong effect on avoiding surface defects to reach the desired quality of the products and fulfill the product specifications. This is the base for selection and preparation of an emulsion and must also be considered for the reuse of a recirculated emulsion.

Degradation and impurities lower the performance of the rolling emulsions. Over time, the emulsion is degraded by mechanical and thermal stress in the rolling process and/or is contaminated by iron fines, by the presence of microorganisms, by acid from the preliminary stripping lines or by the oils used in the process or other parts of the rolling mill.

Deterioration by thermal or chemical reactions in cold rolling can cause staining on steel strips. Lubrication and cooling properties of the emulsion as a complex dispersed system are due to its grade of emulsion stability which is affected as well. The fracture of the lubrication film on the strip is possible as a result of degraded emulsions. This defect on lubrication can cause local overheating and interaction issues between rolls and the sheet surface. For example, heat scratches on the sheet can destroy the desired surface properties of the sheet. Local overheating can produce microweldings between the working rolls and the sheet. Their subsequent demolition causes deformations on both the surfaces of the rolls and the sheets. Wrinkling of the sheet is also an unwanted effect of poor lubrication which makes the sheet unusable. Indentations are depressions observed on the strip which occur periodically and are caused by foreign bodies on working rolls or rollers. Pimples are periodical ‘high spots’ caused by small cavities in the work roll surface.

Operators seek to minimise as much as possible the consumption of pure oil (in the case of stainless steel production) or emulsions (in the case of carbon steel production). This is done, in particular, by removing the impurities and recirculating the oil/emulsion. Nevertheless, as the quality of the oil/emulsion gradually decreases, a complete or partial replacement will become necessary to maintain the quality to achieve the product requirements. [[29, EUROFER 2021](#)]

When quality requirements allow for the recirculation of the rolling emulsion, particulate matter (e.g. dust, steel slivers and scale) contaminating the rolling emulsion is removed in a cleaning circuit (usually based on sedimentation combined with filtration and/or magnetic separation) in order to maintain the emulsion quality and the treated rolling emulsion is reused. The degree of reuse is limited by the content of impurities in the emulsion. Indeed, rolling emulsions have an effect on product quality and therefore product quality requirements need to be checked before allowing for the right level of recirculation. Otherwise, a low-quality rolling emulsion could lead to surface defects (e.g. heat scratches or unintentionally deepenings of the material). [[3, EUROFER 2020](#)]

Achieved environmental benefits

- Reduced consumption of new cold rolling emulsion.
- Reduced waste water volume.

Environmental performance and operational data

No information provided.

Cross-media effects

None.

Technical considerations relevant to applicability

Applicability may be restricted due to product specifications.

Economics

No information provided.

Driving force for implementation

Material efficiency.

Example plants

Widely used.

Reference literature

[3, EUROFER 2020], [16, FMP TWG 2018], [29, EUROFER 2021].

3.4.2.9 Treatment of spent rolling emulsion

Description

The partial flow of the emulsion circuit cleaning system that is discarded is de-oiled in an emulsion splitting plant into oil sludge and water, and the purified water is then discharged. The separated, oil-containing sludge may be used in the blast furnaces or coke oven batteries in an integrated steelworks. [25, EUROFER 2018]

Technical description

Treatments available comprise:

- thermal: by evaporation and splitting with chemical additions;
- chemical: acid splitting, salt splitting, combined dosage of coagulants and polyelectrolytes;
- flotation;
- adsorption;
- electrolytical;
- membrane filtration (ultrafiltration, reverse osmosis).

See Section 8.9 for additional information on these techniques.

Achieved environmental benefits

Reduced emissions to water.

Technical considerations relevant to applicability

Generally, there are no technical restrictions to the applicability of this technique.

Thermal treatment

Environmental performance and operational data

No information provided.

Cross-media effects

- High energy consumption.
- Waste gas treatment required.
- Little COD in effluent. [106, R. Woll, ZF-Getriebe GmbH 1995]

Economics

No information provided.

Driving force for implementation

No information provided.

Chemical treatment**Environmental performance and operational data**

No information provided.

Cross-media effects

- Generation of additional oil-containing neutralisation sludges. [82, DE, TWG member 1999]
- Consumption of chemicals. [106, R. Woll, ZF-Getriebe GmbH 1995]
- COD in effluent. [106, R. Woll, ZF-Getriebe GmbH 1995]

Economics

No information provided.

Driving force for implementation

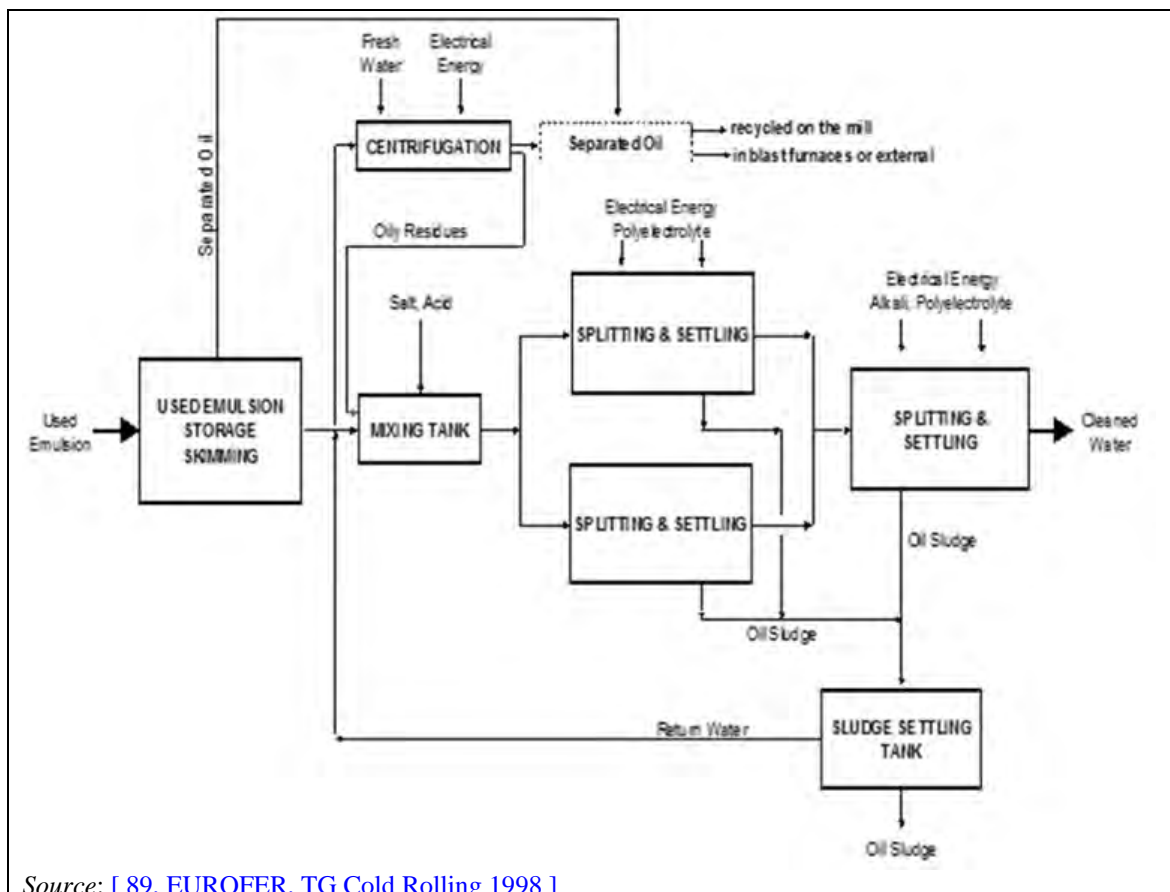
No information provided.

Reference literature

[16, FMP TWG 2018], [25, EUROFER 2018], [82, DE, TWG member 1999], [106, R. Woll, ZF-Getriebe GmbH 1995].

Electrolytic treatment**Environmental performance and operational data**

Figure 3.56 shows an example of an emulsion splitting system using electrolytic splitting.



Source: [89, EUROFER, TG Cold Rolling 1998]

Figure 3.56: Spent emulsion splitting system

Table 3.21: Operational data for electrolytic emulsion splitting

Input / Consumption Level				
	Tandem Mill		Reversing Mill	
Spent emulsion	5 - 13	kg/t	0.06	m ³ /t
Industrial water	0.5 - 1	kg/t	NI	
Salt	0.025 - 0.05	kg/t	0.125 (NaCl)	kg/t
Polyelectrolyte	0.003 - 0.005	kg/t	0.012	kg/t
Al-Anodes	0.003 - 0.006	kg/t	0.012	kg/t
Electrical energy	5 - 10	MJ/t	3 - 3.5	MJ/t
Output / Emission Level				
Purified waste water	5 - 13	kg/t	0.06	m ³ /t
Water (-> coke plant)	NI		NI	
Oily sludge (disposal)	0.1 - 0.3	kg/t	1.9	kg/t
Oily sludge (internal recycling)	2.5 - 3.5	kg/t	NI	
Oil (+/- 20 % water, → blast furnace)	1.3 - 2	kg/t	NI	
	Concentration [mg/l]	Specific Emission [kg/t product]	Reduction rate ¹ [%]	Method of analysis
Settleable solids	7 - 10	5.8 - 8 E -5	> 90	DIN 38409-H9
Σ Hydrocarbons	6 - 18	5.2 - 18 E -5	> 90	DIN 38409-H18
Chlorides	800 - 1400	6.7 - 10 E -3	NI	DIN 38405-D1
Sulphide	0.004 - 0.4	3.3 - 330 E -8	NI	DIN 38405-D26
NO ₂ ⁻	8 - 10	8 - 9 E -5	NI	DIN 38405-D19
Pb total	0.03 - 0.3	2.65 - 27 E -7	> 90	DIN 38406
As total	0.075 - 0.1	6.2 - 7.5 E -7	> 90	DIN 38406
Zn total	0.08 - 1.6	6.6 - 132 E -7	> 90	DIN 38406
Ni total	0.4 - 0.5	3.3 - 4 E -6	> 90	DIN 38406
Cr total	0.008 - 0.4	6.6 - 2500 E -8	> 90	DIN 38406
Cu total	0.06 - 0.4	5 - 33 E -7	> 90	DIN 38406
AOX	0.1 - 0.4	8.3 - 32 E -7	NI	DIN 38409-H14
BTX	0.02 - 0.08	1.7 - 6.6 E -7	NI	DIN 38407-F9
Temperature	28 °C	NI	NI	Thermometer
pH	7.6	NI	NI	DIN 38405-C5
Notes:				
- Source: [89, EUROFER, TG Cold Rolling 1998]				
- Data based on weekly, volume proportional 24-h sampling				
NI = No information provided.				

Cross-media effects

All of the oil contained in the emulsion has to be removed as sludge.

Economics

No information provided.

Driving force for implementation

No information provided.

Ultrafiltration**Environmental performance and operational data**

- No chemical addition required. [107, SIDMAR 1999]
- No oily sludge is generated. [107, SIDMAR 1999]
- Nearly 100 % oil removal efficiency, independent of influent oil content. [107, SIDMAR 1999]

Cross-media effects

No information provided.

Economics

Cost reduction.

Driving force for implementation

No information provided.

Example plants

ArcelorMittal Ghent. [25, EUROFER 2018]

General list of plants reporting any of the treatment of spent rolling emulsion techniques: 08 CR, 45 CR, 94 CR, 102 CR, 110 CR1, 110 CR2, 116 CR, 128 CR, 158 CR, 159 CR, 179 CR, 180 CR1, 193 CR, 194 CR, 195 CR, 201 CR, 225 CR, 244 CR, 249 CR,.

Reference literature

[16, FMP TWG 2018], [25, EUROFER 2018], [107, SIDMAR 1999].

3.4.2.10 Air extraction as close as possible to the source for emissions from rolling

Description

Emissions from rolling are collected, for example using hood or lip extraction. Separators containing baffle packing, impingement plates or mesh pads are used to separate the oil from the extracted air.

Technical description

Rolling emulsion or rolling oil fumes from the mill stands are extracted and passed through separators for cleaning. Eliminators containing baffle packing and impingement plates or mesh pads to separate the oil from the extracted airflow and in some cases electrostatic precipitators are used. The separated emulsion/oil can be returned to the emulsion/oil system. [25, EUROFER 2018]

Achieved environmental benefits

- Reduction of emulsion fumes, efficiency > 90 %.
- Reduction of oil mist emissions from cold rolling. [25, EUROFER 2018]

Environmental performance and operational data

In general, TVOC emissions of less than 10 mg/Nm³ can be achieved as an annual average. [25, EUROFER 2018]. Table 3.23 summarises emissions data of TVOC for tandem and reversing mills in the FMP data collection.

Table 3.22: TVOC emission concentrations in tandem and reversing mills

Substance	Concentrations reported over 3-year period - (mg/Nm ³)				Number of plants / number of measurements
	Average	Median	Min.	Max.	
Reversing mills					
TVOC	4.0	3.5	0.1	10.2	5 / 20
Tandem mills					
TVOC	4.8	5.1	0.2	12.3	4 / 27
<i>Source: [16, FMP TWG 2018]</i>					

Cross-media effects

Oil recovered from the separators may be recirculated, although in some cases the return of the oil from the emulsion filters might be impossible due to the poor quality of the oil (bacteria). [26, Hot Rolling Shadow Group 1999]

Technical considerations relevant to applicability

Generally, there are no technical restrictions to the applicability of this technique.

Economics

No information provided.

Driving force for implementation

Reduction of oil mist to air. [\[25, EUROFER 2018 \]](#)

Example plants

- Outokumpu Tornio reversing mill (158 CR), mechanical separators and electrostatic filters are both applied.
- Other reversing mills: 88 CR, 116 CR, 144 CR, 225 CR.
- Tandem mills: 110 CR, 128 CR, 130 CR, 249 CR.

Reference literature

[\[16, FMP TWG 2018 \]](#), [\[25, EUROFER 2018 \]](#).

3.4.3 Annealing

3.4.3.1 Reverse cascade degreasing

Description

Degreasing is carried out in two or more baths in series where the feedstock is moved from the most contaminated degreasing bath to the cleanest.

Technical description

The degreasing step is important for the quality of a final annealed strip because minor quantities of oil or emulsion residues can lead to undesirable discolouration of the strip surface and reduce the quality of the final product.

The degreasing operation before annealing and coating removes oil residues and iron fines left on the strip after cold rolling. Usually, for degreasing, the strip is uncoiled and undergoes several steps including pre-degreasing, brushing, electrolytic degreasing, rinsing and drying (see Figure 3.57). At the end of these processes, the strip is coiled again. The reuse of the electrolyte solutions reduces the total liquid flow to be treated. Typically, this is carried out with bath cascades where the fresh electrolyte used in the electrolytic section is reused in the preceding brushing and pre-degreasing sections. [\[108, EUROFER 19-6-17 2017 \]](#)

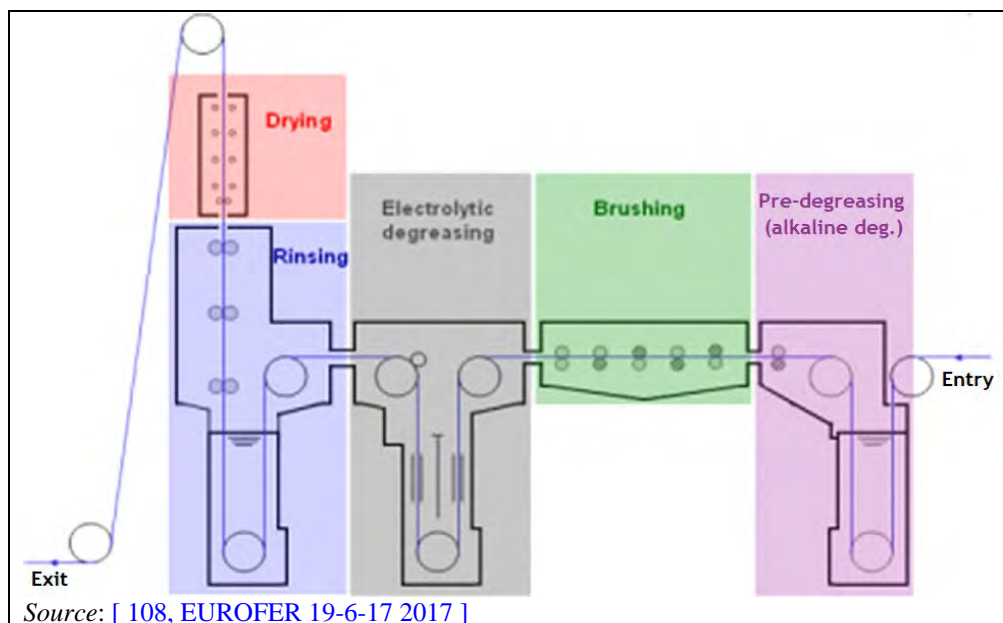


Figure 3.57: Classical degreasing process

Achieved environmental benefits

Reduction of the generation of spent degreasing solution.

Environmental performance and operational data

No information provided.

Cross-media effects

None.

Technical considerations relevant to applicability

Generally, there are no technical restrictions to the applicability of this technique.

Economics

No information provided.

Driving force for implementation

Reduced costs due to increased material efficiency.

Example plants

Plants from the data collection: 88 CR, 144 CR, 158 CR.

Reference literature

[16, FMP TWG 2018], [108, EUROFER 19-6-17 2017].

3.4.3.2 Hot water pre-degreasing

Description

Pre-degreasing is carried out using hot water to eliminate oily and iron dust residues from the surface of the final strip product.

Technical description

Hot water pre-degreasing is a pretreatment step which serves to eliminate most of the oily residues, thus decreasing the subsequent use of degreasing soda. It consists of removing from the steel surface residual oil and iron dust particles originating from prior processing steps,

before the steel enters the annealing furnace. Indeed, oil or iron dust can adversely affect the furnace and the furnace rolls. This can lead to major quality defects, e.g. the appearance of pick-ups on the furnace rolls. [[108, EUROFER 19-6-17 2017](#)]

Usually, degreasing with hot water is done at temperatures between 60 °C and 80 °C. [[108, EUROFER 19-6-17 2017](#)]

The water may be heated, e.g. by a boiler, using the exhaust gases of continuous annealing furnaces of HDG. [[108, EUROFER 19-6-17 2017](#)]

Achieved environmental benefits

No information provided.

Environmental performance and operational data

About 99 % of the residual oil is removed.

Cross-media effects

None.

Technical considerations relevant to applicability

Generally, there are no technical restrictions to the applicability of this technique.

Economics

No information provided.

Driving force for implementation

No information provided.

Example plants

Plant from the data collection: 158 CR.

Reference literature

[[16, FMP TWG 2018](#)], [[108, EUROFER 19-6-17 2017](#)].

3.4.3.3 Regenerative or recuperative burners for annealing furnaces

Description

Annealing furnaces are equipped with regenerative or recuperative burners for preheating the combustion air.

Technical description

See Sections 8.5.4.3 for a detailed technical description.

Achieved environmental benefits

Reduction in energy consumption.

Environmental performance and operational data

Continuous annealing

Based on 8 plants equipped with recuperators or recuperative burners, the energy consumption observed in the FMP data collection ranged from 657 MJ/t to 1422 MJ/t, with a mean value of 984 MJ/t.

Batch annealing

Based on 11 plants equipped with recuperators or recuperative burners, the energy consumption observed in the FMP data collection ranged from 583 MJ/t to 1724 MJ/t, with a mean value of 882 MJ/t.

Cross-media effects

Potential increased NO_x emission level (concentration).

Technical considerations relevant to applicability

Generally applicable within the constraints related to the need to control NO_x emissions.

Economics

No information provided.

Driving force for implementation

Improved energy efficiency.

Example plants

Plant from the data collection: 144 CR, 158 CR.

Reference literature

[16, FMP TWG 2018].

3.4.3.4 Low-NO_x burner for annealing furnaces**Description**

The technique (including ultra-low-NO_x burners) is based on the principles of reducing peak flame temperatures. The air/fuel mixing reduces the availability of oxygen and reduces the peak flame temperature, thus retarding the conversion of fuel-bound nitrogen to NO_x and the formation of thermal NO_x, while maintaining high combustion efficiency.

Technical description

See Section 8.8.2.8 for a detailed technical description.

Achieved environmental benefits

Reduced NO_x emissions.

Environmental performance and operational data

Table 3.23: Emission concentrations of NO_x and CO in batch annealing furnaces

Substance	Concentrations reported over 3-year period (mg/Nm ³)				Fuel used	Number of plants / number of measurements
	Average	Median	Min.	Max.		
NO _x	204	193	34	315	100% NG	3 / 11
CO	29	19	3	88	100% NG	3 / 8
NO _x	370	194	68	1260	100% BFG	1 / 9
CO	209	162	25	540	100% BFG	1 / 8

All the plants in this data set used air preheating.
Source: [16, FMP TWG 2018]

Table 3.24: Emission concentrations of NO_x and CO in continuous annealing furnaces

Substance	Concentrations reported over 3-year period (mg/Nm ³)				Fuel used	Number of plants / number of measurements
	Average	Median	Min.	Max.		
NO _x	323	349	82	488	100% NG	5 / 23
CO	120	93	3	290	100% NG	4 / 8
NO _x	277	274	256	308	100% COG	1 / 8

All the plants in this data set used air preheating.
Source: [16, FMP TWG 2018]

Cross-media effects

No information provided.

Technical considerations relevant to applicability

Applicability may be restricted at existing plants by design and/or operational constraints.

Economics

No information provided.

Driving force for implementation

Environmental legislation.

Example plants

Batch annealing plants: 08 CR4, 08 CR5, 115CR1, 193 CR1, 193 CR2.

Continuous annealing plants: 08 CR3, 37 CR5, 94 CR1, 98 CR1, 130 CR1, 130 CR2.

Reference literature

[[16, FMP TWG 2018](#)], [[18, CITEPA 1994](#)].

3.4.3.5 Selective catalytic reduction (SCR) in continuous annealing lines

Description

The SCR technique is based on the reduction of NO_x to nitrogen in a catalytic bed by reaction with urea or ammonia at an optimum operating temperature of around 300–450 °C. Several layers of catalyst may be applied. A higher NO_x reduction is achieved with the use of several catalyst layers.

Technical description

A general description of the SCR technique is presented in Section 8.8.2.13.

Waste gases from the radiant tube burners in the heating furnace of the continuous annealing line are passed through a SCR plant to reduce the NO_x content. The flow rate, temperature and NO_x concentrations in the waste gases depends on the type of strips produced and can change very rapidly. Before the waste gases reach the SCR plant, the waste gases pass a preheating furnace section where the hot gases heat up the incoming cold strip. Any oil on the strip will evaporate and be also entrained with the waste gases through the SCR plant. [[31, EUROFER 10-7-18 2018](#)]

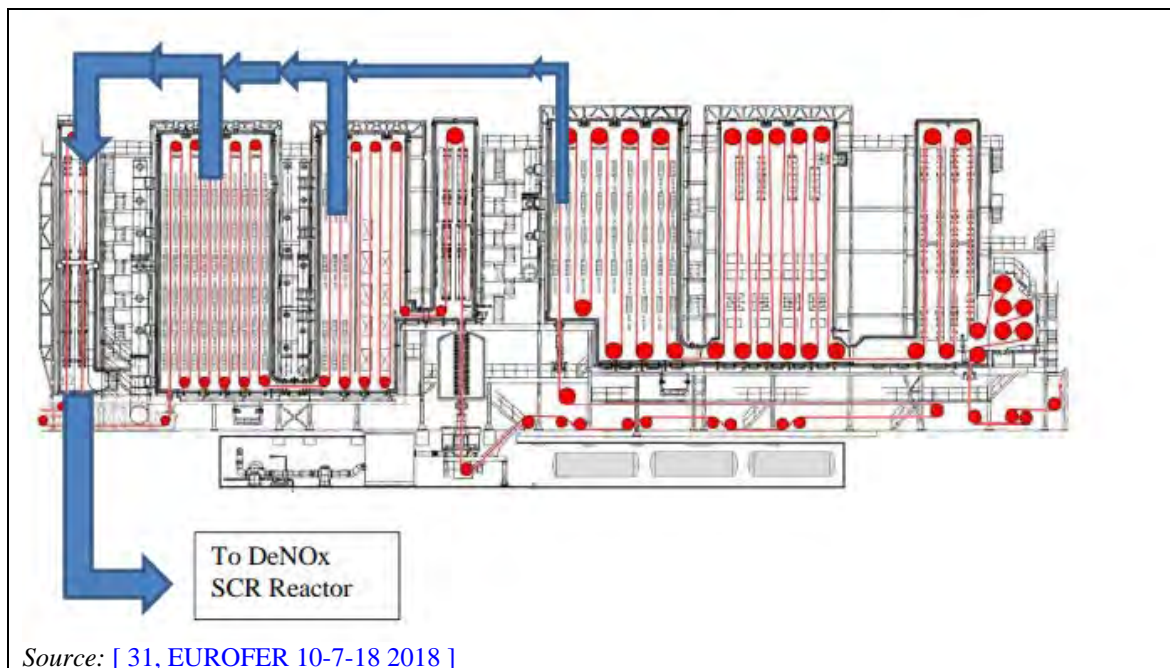


Figure 3.58: Overview of the continuous annealing line at SSAB Borlänge cold rolling mill (Sweden)

In the SCR reactor, the reaction takes place between three catalyst layers (V_2O_5 and TiO_2) where a solution containing 25 % NH_3 is injected in the waste gases. Since the working temperature of the catalyst is between $160^\circ C$ and $400^\circ C$, the injection of NH_3 solution will only be done when the waste gas temperature is within this range. In the case of very high temperatures, an air cooling fan is used to maintain the temperature within these limits. Below $100^\circ C$ or above $400^\circ C$, the waste gases are going through a by-pass system in order to protect the catalyst. The best performance is achieved when the waste gas temperatures are within the range $160^\circ C$ to $400^\circ C$ with stable flow rates.

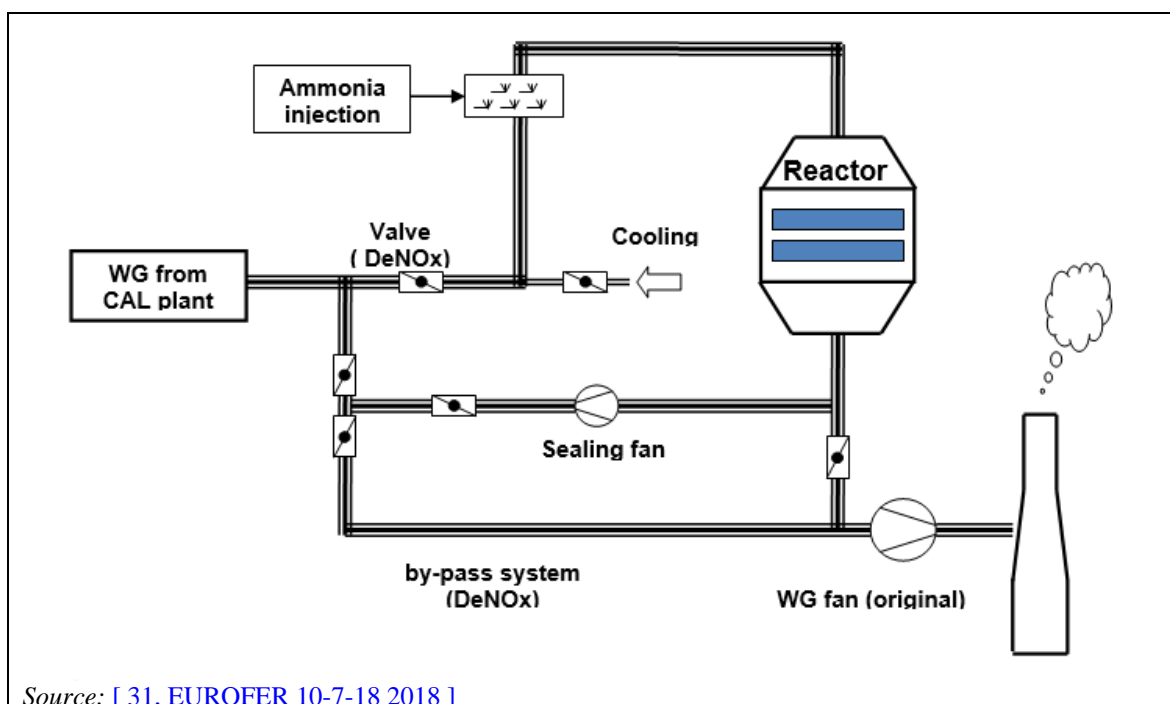


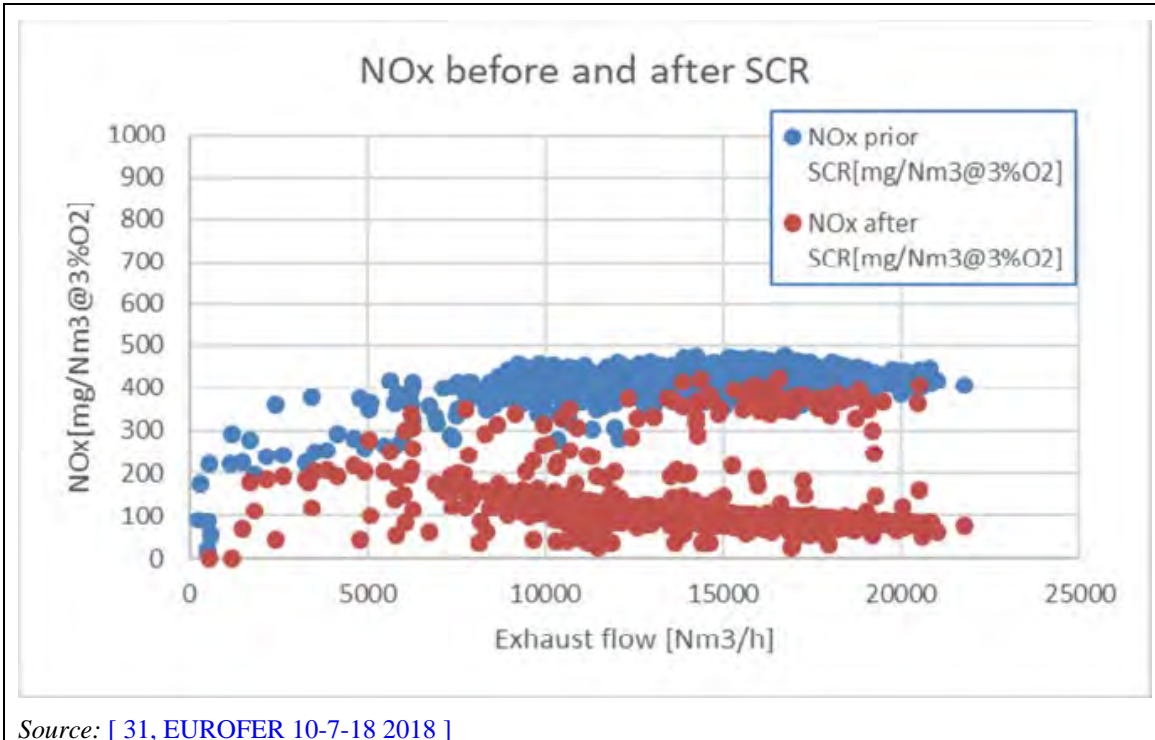
Figure 3.59: Schematic of the treatment using SCR of waste gases from the continuous annealing line at SSAB Borlänge cold rolling mill (Sweden)

Achieved environmental benefits

Reduced NO_x emissions.

Environmental performance and operational data

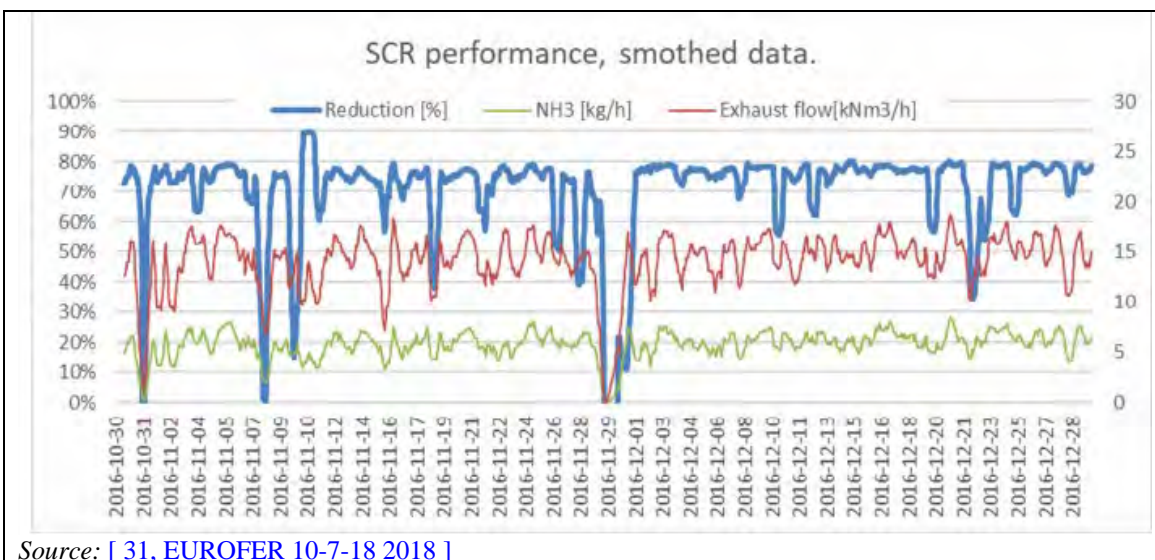
In 2016, plant 244 (SSAB Borlänge cold rolling mill – Sweden) in the FMP data collection reported NO_x emission concentrations within the range 80 to 200 mg.Nm³ with a mean value of 113 mg / Nm³, and an average exhaust gas flow rate of 12 500 Nm³/h.



Source: [31, EUROFER 10-7-18 2018]

Figure 3.60: NO_x emission concentrations at SSAB Borlänge cold rolling mill (Sweden) before and after the SCR abatement system

Figure 3.61 summarises the abatement efficiency of the SCR system together with the ammonia consumption and the exhaust gas flow rates at SSAB Borlänge cold rolling mill. An abatement efficiency of 75% is generally achieved.



Source: [31, EUROFER 10-7-18 2018]

Figure 3.61: Abatement efficiency of the SCR system (%), ammonia consumption expressed in kg/h and exhaust gas flow rates expressed in kNm³/h at SSAB Borlänge cold rolling mill (Sweden)

Cross-media effects

This technique requires the injection of an ammonia solution (25%) with potential environmental and safety aspects related to the media. This will generate an ammonia slip with unreacted ammonia passing through the SCR process. Measured NH₃ during the the first years of operation at SSAB showed that emission concentrations in the range 2-3 ppm NH₃.

Technical considerations relevant to applicability

An SCR system built as an independent unit requires significant space. When retrofitting existing plants, in certain cases this may result in constraints. Therefore, applicability to existing plants may be restricted by a lack of space.

Economics

Total costs for the reduction of NO_x by catalytic reduction has to include the investments costs, running costs and maintenance. Based on SSAB Borlänge cold rolling mill, the total costs of this technique are estimated to be around 13 Euro per kg reduced NO_x.

Driving force for implementation

Environmental legislation.

Example plants

SSAB Borlänge – Plant 244 CR.

Reference literature

[16, FMP TWG 2018], [31, EUROFER 10-7-18 2018].

3.4.3.6 Heat recovery for heating the degreasing bath**Description**

The heat in the exhaust gases of the annealing furnaces is recovered and used for heating the degreasing baths. [108, EUROFER 19-6-17 2017]

Technical description

In annealing lines, the waste heat can be used not only to preheat combustion air but also to heat the degreasing baths. In this case, it is important to consider that steam production is influenced by the product mix (and no steam production occurs when the line stops). For this reason, this source of energy must be integrated in the plant steam network to ensure constant pressure/flow. The possibility of hot water or steam production is related to the temperature of exhaust gases; this is possible with recuperative burners but it is not possible in the case of regenerative burners. This technique can be used both for continuous or batch annealing and hot dip coating lines. [108, EUROFER 19-6-17 2017]

Achieved environmental benefits

Reduced energy consumption.

Environmental performance and operational dataContinuous annealing

Energy consumptions within the range 945 MJ/t to 1200 MJ/t are reported in the data collection.

Batch annealing

An energy consumption of 584 MJ/t is reported by one plant of the data collection using this technique.

Cross-media effects

None.

Technical considerations relevant to applicability

Generally, there are no technical restrictions to the applicability of this technique.

Economics

No information provided.

Driving force for implementation

Energy efficiency.

Example plants

CBI.

Reference literature

[16, FMP TWG 2018], [108, EUROFER 19-6-17 2017].

3.4.4 Tempering

3.4.4.1 Optimisation of wet temper rolling emulsion application systems

Description

In the wet temper rolling process, temper emulsions are applied onto the strip surface using spray nozzles to minimise atomisation and the spray patterns are optimised to the width of the strip in order to reduce oil emissions and consumption.

Technical description

Wet temper rolling consists of applying an emulsion (e.g. temper fluid) onto the annealed strip prior to and during the rolling step. Temper rolling is necessary to attain the required metallurgical properties such as hardness, yield strength of the surface and elongation. The way temper rolling emulsions are applied onto the surface of the strip is optimised in order to reduce both oil emissions and consumption.

In practice, the following measures are taken:

- **Use of low-pressure sprays for the emulsion:**
Atomisation of the temper rolling emulsion has to be minimised by the use of the appropriate type of spray nozzles at the appropriate pressure.
- **Adapt the number of emulsion jets to the width of the strip:**
Since the temper rolling emulsion is not recycled, optimisation of the spray patterns reduces emulsion consumption.

Achieved environmental benefits

- Reduced oil emissions.
- Reduced oil consumption.

Environmental performance and operational data

No information provided.

Cross-media effects

None.

Technical considerations relevant to applicability

Generally, there are no technical restrictions to the applicability of this technique.

Economics

No information provided.

Driving force for implementation

Material efficiency.

Example plants

Plants from the data collection: 08 CR, 37 CR, 45 CR, 88 CR, 102 CR, 105 CR, 110 CR2, 115 CR, 116 CR, 122 CR, 128 CR, 130 CR, 144 CR, 159 CR, 179 CR, 180 CR1, 193 CR, 194 CR, 201 CR, 209 CR, 225 CR, 244 CR, 246 CR1, 249 CR.

Reference literature

[[16, FMP TWG 2018](#)].

3.4.4.2 Dry tempering and low-volume lubrication in wet tempering**Description**

In dry tempering, no water or lubricants are used for tempering.

In wet tempering, low-volume lubrication systems are employed to supply precisely the amount of lubricants needed for reducing the friction between the working rolls and the feedstock.

Technical description

Tempering (e.g. skin-pass milling) is a post-processing step of steel strips after annealing for recrystallisation purposes. Skin-pass milling is carried out to achieve the following goals: fine-adjusting of the mechanical properties, improving the strip flatness and applying a defined surface fine-structure. Skin-pass mills can be operated in the wet or dry mode. There are applications where only the wet temper application (e.g. especially with higher extensions) are used and other applications where wet tempering cannot be applied.

Skin-pass mills exist as stand-alone facilities or are installed after the continuous furnace in hot dip galvanising continuous annealing lines for in-line treatment of the annealed steel strip. Depending on the type of products, skin-pass mills can be configured as a duo, four-high stand, six-high stand or X-high mill. In the case of a four-high stand configuration, a very common layout at the time of writing this document, there are two back-up rolls and two working rolls. The working roll diameter and surface structure can be chosen depending on steel grade, strip dimension and customer requirements. [[70, EUROFER 31-5-17 2017](#)]

Dry tempering

In the dry mode, no water or any kind of fluid medium is used for lubrication. [[70, EUROFER 31-5-17 2017](#)]

If processing uncoated steel (e.g. during in-line skin-pass milling in a continuous annealing line), operating the skin-pass mill in a 'dry mode' will be favoured. This means that no water or any other kind of fluid is used to clean the back-up or working rolls. Although the dry mode is very efficient to avoid rust points, unfortunately it increases the amount of particles which can cause surface defects. In particular, this occurs when dust originating from the wear of rolls and strip is not removed sufficiently from the skin-pass mill due to the absence of a cleaning medium. [[70, EUROFER 31-5-17 2017](#)]

Recent developments concerning (dry) skin-pass milling focus on processing steels with increasing strength (e.g. the so-called advanced high-strength steels, AHSS), avoiding quality defects (e.g. dirt on the steel surface) and fulfilling specifications regarding steel surface appearance for high-quality applications (e.g. automotive outer panel parts). Therefore, existing stand-alone or in-line skin-pass mills have to be modernised continuously. Additionally, the surface fine-structure of the working rolls used underlies an ongoing development regarding new texturing methods and/or improved surface properties of the steel strip to be processed. [[70, EUROFER 31-5-17 2017](#)]

Low-volume lubrication in wet tempering

New developments in wet skin-pass mills operation also include the use of low-volume lubrication systems and liquid nitrogen for cleaning the strip surface and work rolls. Using a low-volume lubrication system, the lubricant is applied in the skin-pass stand entry, it reduces the friction in the roll gap and improves the flatness while minimising oil consumption. [[109, Holz et al. 2010](#)]

With regard to tempering of stainless steel, the aim is two-fold: to improve the band flatness after the last annealing step and to increase the brightness in order to obtain a glassy aspect (2B finish) or mirror finish (2R bright annealed finish). This is mostly carried out using a 2-high reversing mill under dry conditions since the thickness reduction per pass is very small and the process is athermal. Another option is to integrate the temper mill at the exit end of the continuous annealing line in the form of two bridge roll sets. For these lines, tempering may involve the use of a mixture of water and additives. However, this technique may only be used with limitations due to quality and finishing requirements of stainless steel. [29, EUROFER 2021]

Achieved environmental benefits

- Prevention of oil mist / TVOC emissions to air.
- No oil consumption in the case of dry skin-pass mills.
- Reduced oil consumption in the case of skin-pass mills equipped with low-volume lubrication systems.

Environmental performance and operational data

No information provided.

Cross-media effects

- Dry tempering generates emissions to air.
- Dry tempering requires an exhaust system and generates waste (filter dust).

Technical considerations relevant to applicability

- Dry tempering is not applicable to tinplate packaging products and other products with high elongation requirements.
- In the case of low-volume lubrication in wet tempering, applicability may be restricted due to product specifications in the case of stainless steel.

Economics

No information provided.

Driving force for implementation

- Prevention of oil mist / TVOC emissions to air.
- Increased material efficiency.

Example plants

- Thyssenkrupp Steel Europe AG - Dortmund, Four-high stand with low-volume lubrication and liquid nitrogen (Plant 130 CR in the data collection).
- Other example plants in the data collection: 17 CR, 37 CR, 98 CR2, 116 CR2.

Reference literature

[29, EUROFER 2021], [70, EUROFER 31-5-17 2017], [109, Holz et al. 2010].

3.4.4.3 Cleaning of temper mill emulsion

Description

Temper mill emulsions containing only a few volume percent of oil are used as lubricant and roll coolant in sheet temper mills. The emulsions are treated after use to separate oil from water. [25, EUROFER 2018]

Technical description

Temper mill emulsions as well as high pressure roll cleaning water are collected together in a sump located underneath the skin pass mill. From the sump, the water oil is pumped to an oil separator. This new solution consisting of high pressure cleaning water, temper mill emulsion

and zinc particles is sent to waste water cleaning. For treatment, different techniques are available, mainly: [\[25, EUROFER 2018 \]](#)

- mechanical (e.g. centrifugation);
- chemical (e.g. emulsion splitting).

Achieved environmental benefits

Reduced emissions to water.

Environmental performance and operational data

The volume of waste can be reduced by 10% to 20%. Typically, an emulsion containing 5% oil can be concentrated into a sludge containing more than 90% pure oil.

The required purity of the water for high pressure cleaning is very high. Clogging can be expected if the skin pass mill waste water is reused. [\[25, EUROFER 2018 \]](#)

Cross-media effects

Energy and raw material consumption.

Technical considerations relevant to applicability

Generally, there are no technical restrictions to the applicability of this technique.

Economics

High investment costs and medium operation costs.

Driving force for implementation

- Environmental requirements.
- Cost requirements.
- Yield increase and quality requirements.
- The concentrated oil can be easily used in primary installation (e.g. blast furnaces, sinter plants, coke ovens) to increase coke bulk density. [\[25, EUROFER 2018 \]](#)

Example plants

Plants from the data collection: 08 CR-L1, 37 CR-L1, 45 CR-L1, 105 CR-L1, 110 CR1-L1, 110 CR2-L1, 115 CR-L1, 116 CR-L1, 122 CR-L1, 128 CR-L1, 130 CR-L1, 158 CR-L1, 159 CR-L1, 179 CR-L1, 193 CR-L1, 194 CR-L1, 195 CR-L1, 209 CR-L1, 225 CR-L1, 244 CR-L1, 246 CR1-L1, 246 CR2-L1, 249 CR-L1.

Reference literature

[\[16, FMP TWG 2018 \]](#), [\[25, EUROFER 2018 \]](#).

3.4.4.4 Air extraction as close as possible to the source for emissions from wet tempering

Description

Emissions from wet tempering are collected, for example using hood or lip extraction. The waste gases are treated using a demister and/or an oil mist separator.

Technical description

Oil mist in wet tempering is extracted as close as possible to the source via an exhaust system, e.g. using hood or lip extraction. Oil mist is treated using a demister and/or an oil mist separator.

Achieved environmental benefits

Reduction of hydrocarbon emissions to air. [\[25, EUROFER 2018 \]](#)

Environmental performance and operational data

Based on emissions data reported by two plants from the FMP data collection, TVOC emissions were within the range 2.3 to 9.4 mg / Nm³, with a mean value of 5.4 mg /Nm³. [\[16, FMP TWG 2018 \]](#)

Cross-media effects

- Increased energy consumption. [\[25, EUROFER 2018 \]](#)
- Generation of sludge residues, which have to be recycled or disposed of externally. [\[25, EUROFER 2018 \]](#)

Technical considerations relevant to applicability

Generally, there are no technical restrictions to the applicability of this technique.

Economics

No information provided.

Driving force for implementation

Reduction of oil mist emissions.

Example plants

Plants from the data collection: 179 CR3, 249 CR6.

Reference literature

[\[18, CITEPA 1994 \]](#), [\[25, EUROFER 2018 \]](#).

3.4.4.5 Air extraction and abatement in dry tempering

Description

Emissions are extracted as close as possible to the source, e.g. using hood or lip extraction The extracted air is treated by a fabric filter.

Technical description

Dust from dry temper mills is extracted as close as possible to the source via an exhaust system, e.g. using hood or lip extraction. Dust is abated by a fabric filter.

Achieved environmental benefits

Reduction of dust emissions to air. [\[25, EUROFER 2018 \]](#)

Environmental performance and operational data

Based on emissions data reported by two plants operating dry temper mills in the FMP data collection, a mean value of 6 mg/Nm³ was reported for TVOC emissions. [\[16, FMP TWG 2018 \]](#)

Cross-media effects

- Increased energy consumption. [\[25, EUROFER 2018 \]](#)
- Generation of dry residues, which have to be recycled or disposed of externally. [\[25, EUROFER 2018 \]](#)

Technical considerations relevant to applicability

Generally, there are no technical restrictions to the applicability of this technique.

Economics

No information provided.

Driving force for implementation

No information provided.

Example plants

Plants from the data collection: 98 CR2, 116 CR2.

Reference literature

[16, FMP TWG 2018], [18, CITEPA 1994], [25, EUROFER 2018].

3.4.5 Finishing**3.4.5.1 Air extraction as close as possible to the source****Description**

Oil mist emissions from spray oiling finishing operations are extracted as close as possible to the source, using for example hood or lip extraction, and are treated using a demister.

Technical description

Oil emissions that arise from spraying oil mist on strips for conservation purposes can be reduced by extraction hoods or lip extraction, followed by a demister and electrostatic precipitator. The oil captured in the mist eliminator can be recirculated into the oiling process. Nevertheless, spray oiling is used less frequently and electrostatic oiling is applied instead.

Achieved environmental benefits

- Reduction of fugitive oil mist emissions.
- Reduced oil consumption.

Environmental performance and operational data**Example**

By the described measure it is possible to capture the mist arising from oiling almost completely (visual judgement: all visible emissions are captured). The mist eliminator efficiency was reported to be 72 %. Measurements of the waste gas showed concentrations of oil droplets after the mist eliminator, but before the EP, of up to 296 mg/m³ (average 104 mg/m³). The maximum concentration measured after the EP was 6.3 mg/m³ with an average emission of 3.0 mg/m³. The efficiency of the EP was between 97 % and 98 %. The carbon contents of the unabated waste gas was measured 17.5–21.3 mg/m³; after the EP around 10.6–11.9 mg/m³. [75, Batisch et al. 1996]

Cross-media effects

None.

Technical considerations relevant to applicability

Generally, there are no technical restrictions to the applicability of this technique.

Economics

No information provided.

Driving force for implementation

No information provided.

Example plants

Plants using capture and abatement of oil mists: 115 CR and 244 CR.

Plants using electrostatic oiling: 08 CR, 94 CR, 110 CR2, 111 CR, 115 CR, 128 CR, 159 CR, 195 CR.

Reference literature

[75, Batisch et al. 1996].

3.4.5.2 Air extraction as close as possible to the source for emissions from levelling and welding

Description

Emissions from levelling and welding are collected, for example using hood or lip extraction. Particulate emissions are abated using fabric filters.

Technical description

Particulate emissions from welding and levelling are captured by hoods and abated by fabric filters. [\[18, CITEPA 1994 \]](#)

Achieved environmental benefits

Reduction of emissions to air, especially fugitive dust.

Environmental performance and operational data

- Dust emissions from welding reported by one plant (ArcelorMittal Ghent, BE) using a fabric filter ranged between 0.3 mg/Nm³ and 3.4 mg/Nm³. [\[16, FMP TWG 2018 \]](#)
- Another plant producing welded mesh (Alfa Acciai S.p.A., IT) reported dust emissions between 0.2 mg/Nm³ and 5.4 mg/Nm³. This plant also used a fabric filter. [\[16, FMP TWG 2018 \]](#)

Cross-media effects

- Increased energy consumption.
- Generation of waste (filter dust).

Technical considerations relevant to applicability

May not be applicable for welding in the case of low levels of dust generation e.g. below 50 g/h. In the case of welding, the data collection showed that three CR plants reported very different dust mass flows (i.e. Plant 37-CR1: 20 g/h, Plant 94-CR1: 14 g/h and 37-CR2: 97 g/h). Generally, dust emissions from welding in CR are relatively low (in terms of concentrations and mass flows) but, in some cases, more significant emissions may occur. Therefore, it was considered appropriate to include a mass flow threshold of 50 g/h above which extraction and abatement is used to control dust emissions. Dust emissions in cold rolling can be lowered using laser welding (See Section 3.4.1.1), in this case, abatement may not be necessary provided that the dust mass flows are below 50 g/h.

Economics

Fabric filter bags are changed when they start presenting cracks. This change takes about 50 man-hours and requires a stop of the pickling line of at least two shifts – the estimated cost is about EUR 10 000. [\[110, Vanroosbroeck 1999 \]](#)

Driving force for implementation

No information provided.

Example plants

Plants from the data collection 37 CR and 202 CR.

Reference literature

[\[16, FMP TWG 2018 \]](#), [\[18, CITEPA 1994 \]](#), [\[110, Vanroosbroeck 1999 \]](#).

3.4.6 Roll shop

3.4.6.1 Cleaning and reuse of grinding emulsion

Description

Grinding emulsions are treated using lamellar or magnetic separators or using a sedimentation/clarification process in order to remove the grinding sludge and reuse the grinding emulsion.

Technical description

The main function of the grinding emulsion is cooling during the grinding operation and the removal of the grinding sludge containing the residue from the grinding process (grinding stone and metallic roll abrasion). The circulation of the tailor-made water-based emulsion with additives passes the cleaning sections to ensure a residue-free reapplication for the grinding process. To avoid contamination from the rolling emulsion, the rolls are usually cleaned in advance. To maintain the grinding emulsion over a long time in the circulation system, different techniques can be used for cleaning of grinding emulsions in order to remove the grinding sludge. [\[25, EUROFER 2018 \]](#)

The main techniques available for cleaning grinding emulsions are described below:

Lamellar separator

The high solid concentration in the clarifier influences each individual particle, with the result that the sedimentation speed is similar for all particles. Separated particles are discharged intermittently via an automatic sludge conveyor, making manual tank cleaning unnecessary. The settling height in the clarifier is reduced due to the inclined settling surfaces. These surfaces form individual ducts extending across the full width of the sedimentation compartment. The ducts are 20 mm high and are self-cleaning. While the cleaned medium rises to the top of the duct, the separated particles sink into the sludge conveyor. [\[25, EUROFER 2018 \]](#)

Magnetic separators

Magnetic separators can be used in a recirculation system to recover the grinding sludge. However, bacterial contamination can shorten their lifetime. Accordingly, antibacterial additives are employed. A smarter solution can be to treat the cleaned grinding emulsion with UV light in a bypass to keep the bacterial population to a low level which reduces the need for antibacterial agents and improves workplace hygiene. [\[25, EUROFER 2018 \]](#)

Bandex system

The grinding sludge is recovered in a three-step process:

1. pre-sedimentation and venting;
2. sedimentation;
3. clarification. [\[25, EUROFER 2018 \]](#)

Achieved environmental benefits

Environmental protection and work hygiene. [\[25, EUROFER 2018 \]](#)

Environmental performance and operational data

No information provided.

Cross-media effects

Consumption of energy and water. [\[25, EUROFER 2018 \]](#)

Technical considerations relevant to applicability

Generally, there are no technical restrictions to the applicability of this technique. [\[25, EUROFER 2018 \]](#)

Economics

No information provided.

Driving force for implementation

Work hygiene and environment. [\[25, EUROFER 2018 \]](#)

Example plants

Plants from the data collection: 37 CR, 45 CR, 88 CR, 94 CR, 102 CR, 110 CR2, 115 CR, 116 CR, 122 CR, 128 CR, 130 CR, 158 CR, 159 CR, 180 CR1, 193 CR, 194 CR, 195 CR, 197 CR, 242 CR, 244 CR, 246 CR2, 249 CR.

Reference literature

[\[16, FMP TWG 2018 \]](#), [\[25, EUROFER 2018 \]](#).

3.4.6.2 Texturing of work rolls

Description

Surface texturing of working rollers is carried out in dedicated booths equipped with collection hoods. For shot blast texturing, dust emissions are abated using fabric filters while for hard chromium plating, dust emissions are treated using a wet scrubber.

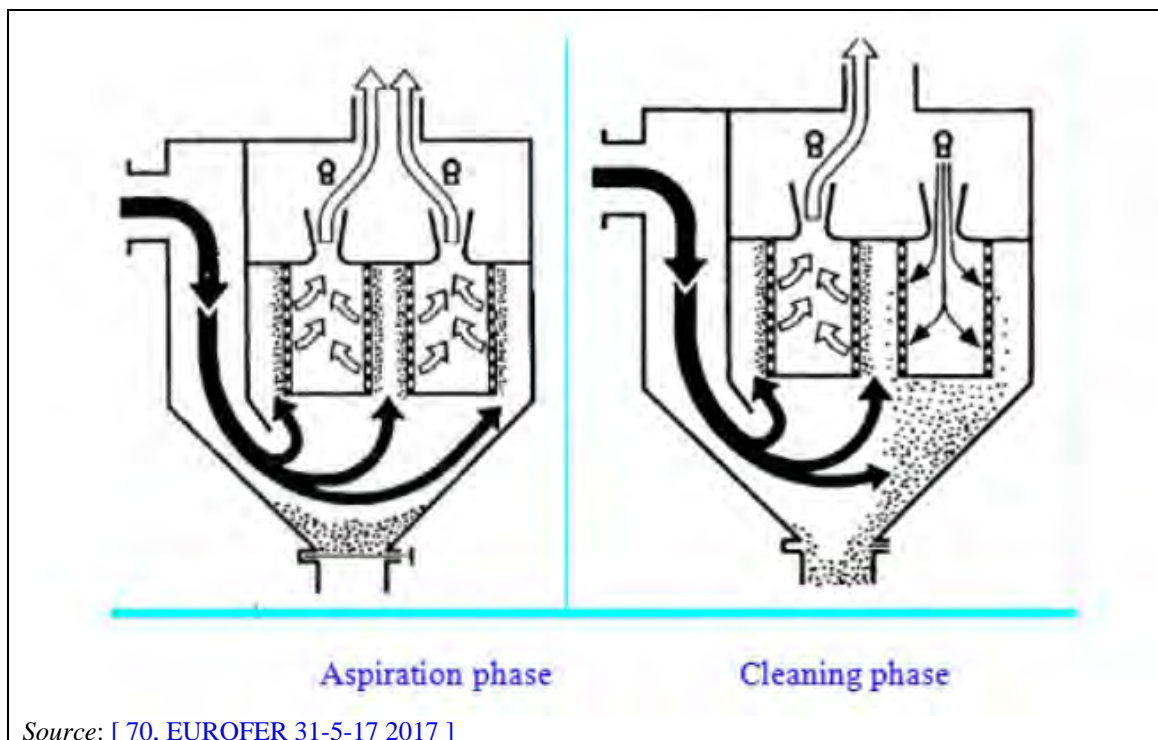
Technical description

Working rollers in cold rolling mills are subjected to surface treatments in order to create specific topography at the surface of the rollers which can be transferred to the steel sheet during rolling operations and gives the final product a new kind of roughness. Surface texturing of rollers can provide good protective paint finishing because the presence of microcavities with small dimensions can minimise the roughness amplitude and increase smoothness after the painting operation. Also, texturing can provide a desirable uniform matte appearance which is of particular interest to the car industry. [\[111, Mello et al. 2013 \]](#), [\[112, Gorbunov et al. 2009 \]](#)

Several methods are employed for texturing of work rolls:

- Shot blast texturing (SBT): In SBT, incisions at the surface of the work rolls are created by shot blasting steel spheres at the surface of the rolling rolls. [\[112, Gorbunov et al. 2009 \]](#)
- EDT (Electrical Discharge Texturing): Electrodes are placed close to the surface of the rotating roller, resulting in an electrical discharge pulse inducing an electrical breakdown. A small section of the roller surface melts and a gas bubble forms. When the pulse is switched off, the bubble breaks down under the action of the external pressure, with splashing of the molten metal. [\[112, Gorbunov et al. 2009 \]](#)
- EBT (Electron Beam Texturing): An electron beam is used to form craters after surface melting of the roller. Some of the molten metal evaporates, while the vapour pressure facilitates the formation of a ring of melt around the crater. The roller turns in a vacuum chamber and moves along an axis. [\[112, Gorbunov et al. 2009 \]](#)
- Laser Tex (Laser Texturing): A laser beam is focused on the roller surface which melts a small area. As a result of the pressure of plasma and inert gas, the melt forced out gathers in a protuberance around the crater or collects at the sides and solidifies. To ensure the required microtopography, the process is regulated by changing the laser power, the radial and axial roller speed, and the modulator speed. [\[112, Gorbunov et al. 2009 \]](#)
- Hard chromium plating: This process consists of coating the work rolls using chromium plating to change the surface topography. In addition, it also helps sustain the surface texture for longer periods. The roller is placed in a chrome-plating electrolyte, within a reactor. A uniform electric field is generated between an electrode and the roller surface. The electrolyte is electrolysed; its content of chromium ions is reduced, and solid chromium is deposited on the roller. [\[112, Gorbunov et al. 2009 \]](#)

For SBT, enclosures and dedicated booths are applied, equipped with collection hoods and dust abatement for the extracted air by fabric filters. [70, EUROFER 31-5-17 2017]



Source: [70, EUROFER 31-5-17 2017]

Figure 3.62: Dust abatement for shot blast texturing operations

The machines are equipped with dust capture and replaceable bag filters. This system is automatic, suitable to treat dry air exhibiting low levels of humidity or oil. The process follows distinct phases as shown in Figure 3.62:

- The waste air enters the first part of the filter and a first settling occurs.
- The air is forced into the hopper in the lower part of the filter and undergoes a second settling to remove the heaviest particles.
- The air goes through the filter and the dust is removed.
- The clean air is expelled to atmosphere. [70, EUROFER 31-5-17 2017]

In hard chromium plating, the plating process is fully enclosed and fitted with an exhaust gas system using a wet scrubber. The whole process operates without effluent discharge because of evaporative losses. [70, EUROFER 31-5-17 2017]

Achieved environmental benefits

Reduction of dust emissions.

Environmental performance and operational data

No information provided.

Cross-media effects

No information provided.

Technical considerations relevant to applicability

No information provided.

Economics

No information provided.

Driving force for implementation

No information provided.

Example plants

Salzgitter Flachstahl GmbH (Germany) – Hard chromium plating.

Plants from the data collection: 37 CR, 45 CR, 116 CR, 122 CR, 128 CR, 158 CR, 159 CR, 244 CR, 246 CR2.

Reference literature

[\[16, FMP TWG 2018 \]](#), [\[70, EUROFER 31-5-17 2017 \]](#), [\[111, Mello et al. 2013 \]](#), [\[112, Gorbunov et al. 2009 \]](#).

3.5 Emerging techniques for cold rolling

3.5.1 Organic Rankine Cycle (ORC) – Heat recovery from excess energy from coils in batch annealing furnaces

Description

The excess energy from coils heated up to 700 °C in a bell-type batch annealing plant is recovered to generate electricity using an ORC system.

Technical description

In a cold rolling batch annealing plant, heated-up coils contain approximately 70 % of the energy input required for the heating to annealing temperatures. During the cooling phase, this heat stored in the coils is normally not recovered. With an annealing base operating with a 100 % hydrogen atmosphere as inert gas, it is possible to extract the heat from the coils in order to heat up a thermal oil using a special bypass cooling system. The thermal oil is used to generate electricity in an ORC system. [113, Schmidt 2016]

Essentially, the energy recovery during the coil cooling phase takes place in two steps. First, hot hydrogen (350-700 °C) is extracted from the annealing base hood. Using a special bypass cooler, the hydrogen heats up a working fluid to a maximum temperature of 270 °C. The heated working fluid is used to evaporate ethanol in an ORC system where electricity is generated using a steam expansion engine. [114, Zwickel et al. 2015]

Achieved environmental benefits

Increased energy efficiency.

Environmental performance and operational data

At Bilstein GmbH batch annealing plant, the ORC system generates 350 kWh of electricity in every annealing heating cycle. In 2014, a total of 1.5 million kWh of energy was recovered. [113, Schmidt 2016]

Cross-media effects

None identified.

Technical considerations relevant to applicability

Generally, there are no technical restrictions to the applicability of this technique.

Economics

The capital investment for this technique is relatively high which necessitates a minimum of 12-15 annealing bases to be equipped in order to have a reasonable pay-back time of approximately 5 to 7 years.

Driving force for implementation

Supply of electricity to the plant distribution network.

Example plants

Bilstein GmbH cold rolling mill, Hagen-Hohenlimburg, Germany.

Reference literature

[113, Schmidt 2016], [114, Zwickel et al. 2015].

4 WIRE DRAWING

4.1 General information on wire drawing

The European Union has the world second largest wire drawing industry after China. It produces about 6 million tonnes of wire per year. When including the various wire products, such as e.g. barbed wire, grill, fencing, netting, nails, the production of the sector reaches more than 7 million tonnes per year. The European wire drawing industry is characterised by a large number of medium sized, specialised companies with an average of around 100 employees. The industry's output, however, is dominated by a few large producers.

Independent wire drawing companies are increasingly vertically integrated. Downstream wire drawing and producing finished wire products have shown a high degree of integration, but also upstream there has been some integration between the steelmaking and wire rod producing industries and wire drawing.

The two largest steel wire producers are Germany and Italy followed by Spain, France, the Czech Republic, Slovakia and Belgium. Other Member States which have a smaller wire drawing industry are e.g. Sweden, the Netherlands, Greece and Portugal. The distribution of wire drawing installations in the EU, their size and the number of plants in each individual Member States is given in Table 4.1. [\[212, Steve Andrews 2022 \]](#)

Table 4.1: Wire drawing industry in Europe

	Wire production [thousand t]	Wire products [thousand t]	Number of plants (Wire drawing)	Number of plants (Wire Products)	Average number of employees per plant
Austria	3 000		3	39	54
Belgium	227 000	200 000	3	18	92
Czech Republic	348 000	236 000			
Finland	2 000				37
France (*)	500 000		23		72
Germany	1 671 000		152	315	144
Greece (*)	100 000		13	119	52
Italy (*)	1 600 000		160	604	
Netherlands	100 000		140 (both)		21
Portugal	67 571	126 000			
Slovakia	253 000				
Spain (*)	900 000		80	293	18
Sweden(*)	120 000		15	130	
Total	5 891 571				
(*) Tonnage is estimated. Source: [212, Steve Andrews 2022]					

4.2 Applied processes and techniques in wire drawing

4.2.1 Wire drawing process overview

Wire drawing is a process in which wire rods/wires are reduced in size by drawing them through cone-shaped openings of a smaller cross section, so-called dies. The input is usually wire rod of diameters ranging from 5.5 mm to 16 mm obtained from hot rolling mills in the form of coils. A typical wire drawing process line comprises the following steps:

- pretreatment of the wire rod (mechanical descaling, pickling);
- dry or wet drawing (usually several drafts with decreasing die sizes);
- heat treatment (continuous/discontinuous annealing, patenting, oil hardening);
- finishing.

Wire is manufactured in different grades of steel: low-carbon steel with a carbon content of up to 0.25 %, high-carbon steel with a carbon content of over 0.25 %, stainless and other alloy steel. Non-alloy steel wire can be uncoated or coated with zinc, copper, brass, tin, nickel, chrome, plastic or varnish. Wire is sent in coil form to further processing, like coating and manufacturing of finished products (e.g. cable, mesh, barbed wire, wire fencing, grill, springs, nails). [7, COM 1997], [117, N.V. Bekaert S.A. 1994]

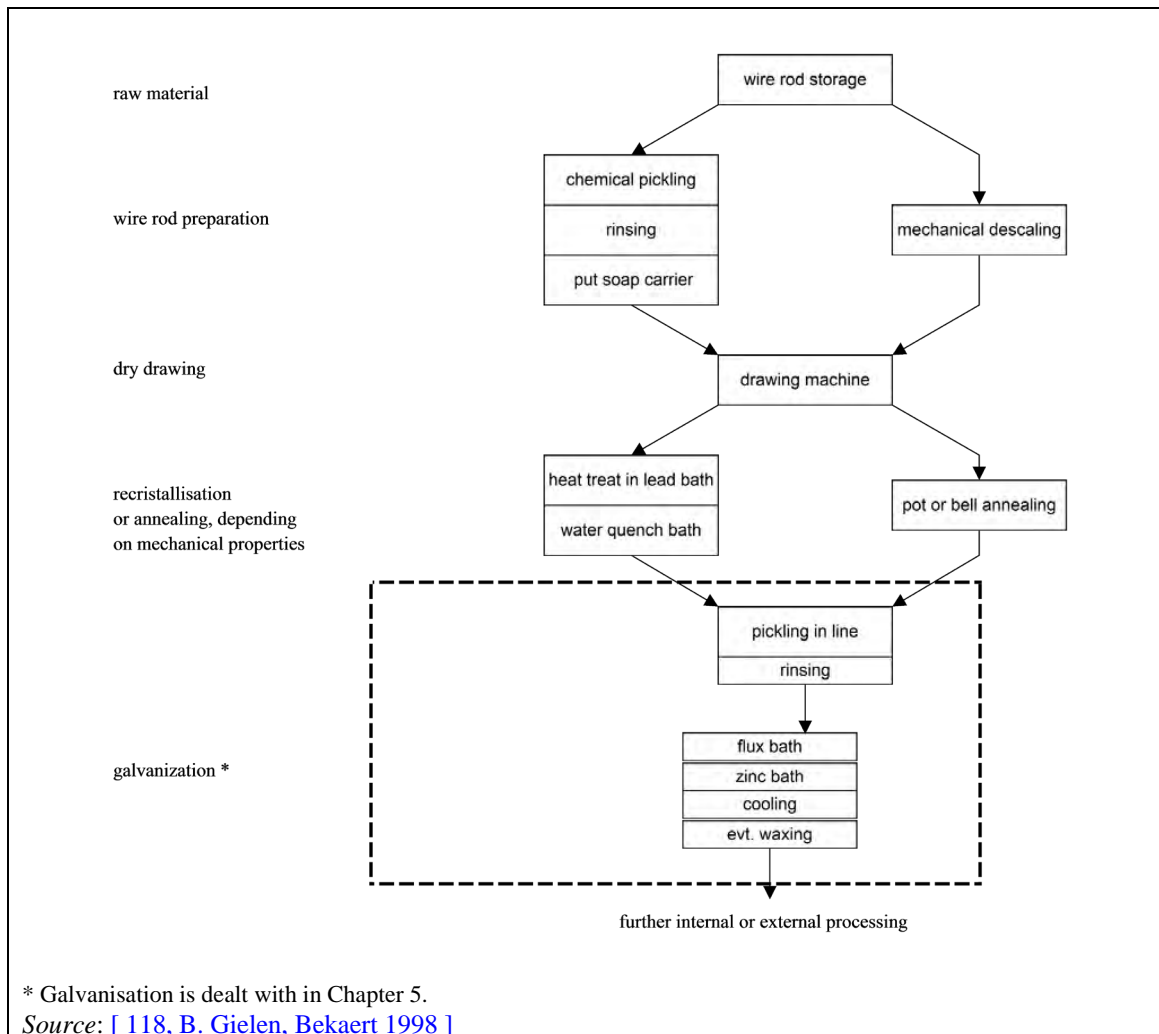


Figure 4.1: Production of low-carbon galvanized wire

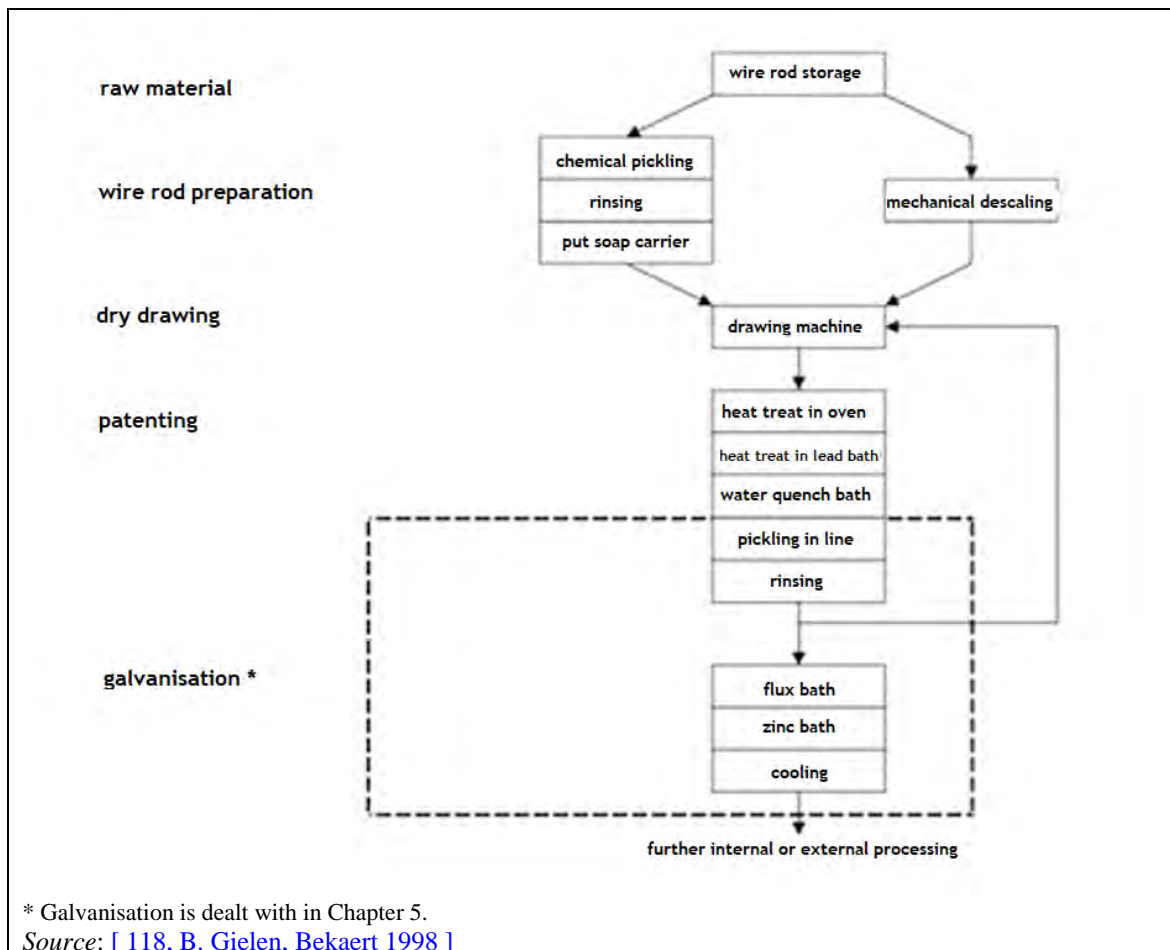


Figure 4.2: Production of high-carbon galvanised wire

Because of the huge variety of wire products, many different processing schemes exist, dictated by the wire diameter and required mechanical and other quality specifications. The process schemes shown in Figure 4.1 and Figure 4.2 cover the majority of galvanised wire that is produced in Europe (and worldwide). A fraction is sold as such but another fraction is processed further by wet drawing or by processes that fall outside the scope of this document, such as welding, electroplating, weaving, cabling, bunching, painting, plastic coating, cutting to length, etc.

4.2.2 Wire rod preparation

Air-cooling after rolling produces an iron oxide layer (scale) on the wire rod surface. This layer is very hard, brittle and not deformable and must therefore be removed before any further processing can take place. In most cases, this is done by the wire industry. For stainless steel however, this is typically done by the steel mill.

Two techniques for descaling wire rods are applied: mechanical descaling and chemical pickling. Some categories of end products can only be produced from mechanically descaled wire at a reduced drawing speed (needing more drawing machine capacity, meaning higher investment costs). The decision on the descaling technique is therefore taken by each individual plant, based on product qualities and economic considerations.

4.2.2.1 Mechanical descaling of wire rod

For the most common mechanical descaling method applied (i.e. wire bending), the wire is bent to cause the brittle scale to peel off. Other descaling techniques, like sanding, brushing or shot blasting, are used as a finishing step after wire bending to remove loose scale or are used as standalone techniques.

Batch shot blasting is a common technique for mechanical descaling of large-diameter wire rod (e.g. used for cold heading applications). However, mechanical descaling is generally done in a continuous way.

Depending on the finish of the wire rod and the quality requirements of the product, descaling by reverse bending is completed or possibly replaced by an abrasive method such as sanding, brushing, shot blasting or stream descaling. By combining reverse bending with one of these auxiliary methods, complete removal of the oxide layer can be achieved, reaching a similar surface cleanliness as with chemical pickling. [\[119, Gielen 2000 \]](#)

Compared to chemical pickling of wire rod, mechanical descaling has the advantage that one production step is eliminated as the descaling unit is normally coupled directly to the drawing machine. However, it is difficult to obtain the same level of drawability with mechanical descaling. [\[118, B. Gielen, Bekaert 1998 \]](#)

4.2.2.2 Chemical descaling (pickling) of wire rod

In chemical descaling, the mill scale is removed by dissolution in acid. Acids used are:

- sulphuric or hydrochloric acid for low-carbon wire;
- hydrochloric acid for high-carbon wire.

Pickling is mostly done in a batch process. Each roll of wire rod is immersed in the acid bath. The acid slowly dissolves the oxide layer by transforming it into iron chlorides or sulphates. When pickling in HCl, an H₂-inhibitor is used to suppress the reaction: $2 \text{HCl} + \text{Fe} \rightarrow \text{FeCl}_2 + \text{H}_2$ and reduce the unwanted loss of iron.

After pickling, the wire rod coils are rinsed in water. This is usually done in cascade rinsing (e.g. rinsing three times) to achieve maximum rinsing efficiency and minimum water consumption. [\[117, N.V. Bekaert S.A. 1994 \]](#), [\[120, B. Gielen 1998 \]](#)

4.2.2.3 Application of soap (lubricant) carrier

In some cases, soap carrier is applied to enhance the adhesion of the lubricant to the wire. A wide range of soap carriers is available. Selection is made on an economic basis and based on required properties in downstream processes. Traditional soap carriers include lime, borax and zinc phosphate. Modern soap carriers are typically mixtures of soluble salts, e.g. sodium and potassium sulphate, chloride, borax, phosphate or silicate. They are adapted to a particular soap and a particular drawing situation.

Soap carrier is applied before drawing by dipping the wire in a watery soap carrier solution. This can be done in a batch process, usually associated with chemical descaling, or continuously in association with mechanical descaling.

4.2.3 Drawing

4.2.3.1 Dry drawing of wire

Dry drawing is typically used to draw wire rod (> 5.5 mm) to a product diameter of 1–2 mm and sometimes even lower. The diameter of the wire is reduced by passing it through a series of dies with diminishing diameters. Before entering the dies, the wire is passed through a dry lubricant. In most cases, soap-based lubricants are used with the soap formulation depending on the choice of fats from which the soap is produced, choice of fillers or choice of additives. In exceptional cases (e.g. special steels, wire with special metal coatings), other lubricants like pastes or oils can be used.

The drawing operation heats both (wire and drawing die) through friction of the wire. Cooling is done indirectly, by cooling the capstans in contact with the wire with water.

4.2.3.2 Wet drawing of wire

Wet drawing is typically used to draw wire with an intermediate product diameter of 1–2 mm to the final diameter. The wire is also passed through a series of dies with diminishing diameters, but wire, dies and capstans are immersed in a lubricant liquid that provides lubrication and cooling. Typically, soap or oil emulsions (for some applications plain oil) are used. The heat resulting from the drawing operation is taken up by the lubricant, which is cooled indirectly with water.

4.2.4 Heat treatment of wire

Heat treatment of wire has different goals. Therefore different types of heat treatment are available depending on the type of steel (low-carbon / high-carbon / stainless) and the final use (desired ductility and strength). Heat treatment also thermally removes soap and lubricant residues.

A considerable percentage of the output of the wire industry does not need any heat treatment. The heavy deformation of the metal crystal structure caused by drawing is mostly a positive property, as it increases the hardness and the strength of the wire in the axial direction.

4.2.4.1 Batch annealing of low-carbon steel wire

Drawing profoundly deforms the shape of the metal crystals of the wire. Annealing is one of the different methods to reobtain a suitable crystal shape. Batch annealing, typically used for low-carbon steel wire to obtain a very soft and ductile end product, is done in bell or pot furnaces.

Batch annealing is done by putting coils of drawn wire in chambers (called ‘pots’ or ‘bells’), filled with a protective gas. The protective gas is either neutral or reducing. The most common protective gases are nitrogen, hydrogen, nitrogen/hydrogen mixtures and partly oxidised natural gas (or similar fuel). The chambers are heated from outside, typically by gas or fuel. The warming up from room to peak temperature (roughly 700 °C) takes several hours; cooling down again also takes several hours. In order to keep an over-pressure in the ‘pots’ or ‘bells’, a fraction of the protective gas is continuously purged.

In some cases, the wire is oiled immediately after annealing.

4.2.4.2 Continuous (in-line) annealing of low-carbon steel wire

Continuous annealing or strand annealing has a similar goal to batch annealing: restore a suitable crystal texture to the steel in the wire after drawing. But the desired crystal shape and metal properties are different to those that are desired when batch annealing is applied. Continuous annealing is a typical heat treatment method for low carbon products.

Strand annealing is a fast continuous process. The wire is heated up to the recrystallisation temperature (500–700 °C), kept at this temperature for a few seconds, and cooled down again by quenching in a water bath.

A typical line is equipped for 15–50 wires and is characterised by a particular $v \times d$ (wire speed \times wire diameter). This means that wires of different diameters can be processed together at the same line, but the greater the diameter of a wire, the lower its speed. Modern lines have a $v \times d$ of 100–200 m/min \times mm (in other words, a 1 mm wire is processed at speeds of 100–200 m/min). For specialities, lines with a few or only one wire and/or operating at a lower $v \times d$ are used. Strand annealing is often combined in one production line with other unit processes, e.g. with hot dip coating.

Commonly, the wire is heated by passing through a molten lead bath. A fast heat-up is essential for strand annealing. Due to the very high heat transfer coefficient of lead (3 000 W/m².K), equilibrium between the wire and lead bath temperature is reached after a few seconds. Other methods such as an oven or inductive heating are alternatives, only in some niches, e.g. one-wire lines, lines operating at low speed or lines designed to run with only one diameter at a time.

After the heat treatment, the wire is generally quenched in water. This can be followed by in-line pickling with warm or cold HCl to remove oxides which also partly dissolves the potentially dragged lead. Other acids or electrolytically assisted pickling can be used as well. Pickling is followed by a rinsing cascade. At some plants, pickling is done as the first operation of the next process step. Often pickling is omitted after heat treatment under a protective atmosphere.

4.2.4.3 Continuous (in-line) annealing of stainless steel wire

Stainless and high-alloy steel wire is continuously annealed to obtain suitable metal crystal properties for (further) drawing operations. For stainless steel, the heat treatment is done under a protective gas atmosphere. If no protective atmosphere was used, the stainless steel wire would be oxidised; removal of these oxides would require pickling with special acids such as HNO₃, HNO₃/HF, etc. (compare with production of stainless steel strip). The temperature profile used varies with the type (content of Ni, Cr or other alloying elements) of stainless steel that is processed (700–1 100 °C).

The wire is passed through tubes or a muffle, under a protective gas. The purge of protective gas is similar to what is described for batch annealing. The first part of the tubes or muffle is placed in an oven (indirect heating of the wire); the second part is cooled indirectly, e.g. by cooling with water. The heating can be done by electricity (resistance heating, inductive heating) or by combustion. [118, B. Gielen, Bekaert 1998]

4.2.4.4 Patenting

Patenting is a heat treatment method typically used for high-carbon and alloy steel products to create a special crystal structure, which allows easy further deformation. In contrast to annealing where iron and iron/carbon compounds tend to be separated, patenting yields a structure where the carbon is homogeneously distributed in the iron.

Patenting is done by heating the wire to 850–1 000 °C, then cooling fast to 450–600 °C and keeping the wire at this temperature for a while, and finally quenching in water. Patenting is usually done continuously and often combined with other unit processes, e.g. hot dip coating.

Heating to 850–1 000 °C is done in an oven where the wire is in contact with the combustion gases. Intermediate cooling and keeping the wire at 450–600 °C is done in a lead bath. For small lines designed for specialities (e.g. fine diameters or mono-wire lines), other heating methods such as heating under a protective gas atmosphere and electric ovens can be used. For the patenting of thick diameters, sometimes a molten salt bath is used.

In the fuel-fired oven, a slight substoichiometric mixture is used in the burners. In this way, all O₂ is excluded from the oven atmosphere, in order to minimise the formation of iron oxides at the wire surface. Excessive formation of iron oxide leads to high losses of wire material and to excessive consumption of pickling acid, and leads to excessive drag-out of lead.

Final cooling is done by quenching in a water bath followed by the same procedure as in continuous annealing.

4.2.4.5 Oil hardening and tempering (oil tempering)

Oil hardening and tempering creates a special crystal structure in the steel with a high percentage of martensite, resulting in increased hardness and wear resistance combined with good toughness. First, the wire is heated to 850–1 000 °C, followed by rapid cooling.

Heating is typically done under a protective atmosphere using electricity (radiation, inductive heating) or combustion. The purge of protective gas is similar to what is described for batch annealing. Quenching is traditionally done in oil, but other quenching media can also be used such as water or water with additions. (Note: although it is not unusual to quench in other media than oil, the normal way of referring to this process step is still oil hardening).

Oil hardening is always followed by a tempering or stress-relieving step, in order to remove the stresses caused by the extremely fast cooling. This is done by heating the wire again to 300–500 °C. Typically a normal oven is used, with electrical heating or direct heating with a typical combustion gas, but inductive heating can also be used.

4.2.4.6 Stress-relieving

The goal of stress-relieving is to remove internal stresses in the wire caused by previous processing steps, without changing the shape and structure of the steel crystal. The internal stresses can be caused by deformation (mechanical stresses) or by fast cooling (thermal stresses). Stress-relieving as a stand-alone heat treatment step is a typical process step for the production of PC strand (wire for prestressed concrete).

Stress-relieving can be done at various temperatures (200–500 °C), dependent on the desired characteristics of the final product. Typically a normal oven is used, with electrical heating or direct heating with a typical combustion gas, but inductive heating can also be used. After stress-relieving, the wire is cooled relatively slowly in air or water. [118, B. Gielen, Bekaert 1998]

4.2.5 In-line pickling

In-line pickling is a typical operation after heat treatment and/or before hot dip coating of wire. It is used to clean the wire and to remove metal oxides. The wire is passed continuously through one or more acid baths. The most common acid is HCl, but other acids can be used. The

pickling takes place in a very short time (a few seconds); therefore the acid is often heated and/or used in concentrated form. After pickling, the wire is rinsed in water.

Finishing of wire includes the application of metallic or non-metallic coatings. Galvanising of wire and in-line pickling of wire are covered in Chapter 5 of this document.

4.3 Current consumption and emission levels for wire drawing

4.3.1 Mass stream overview

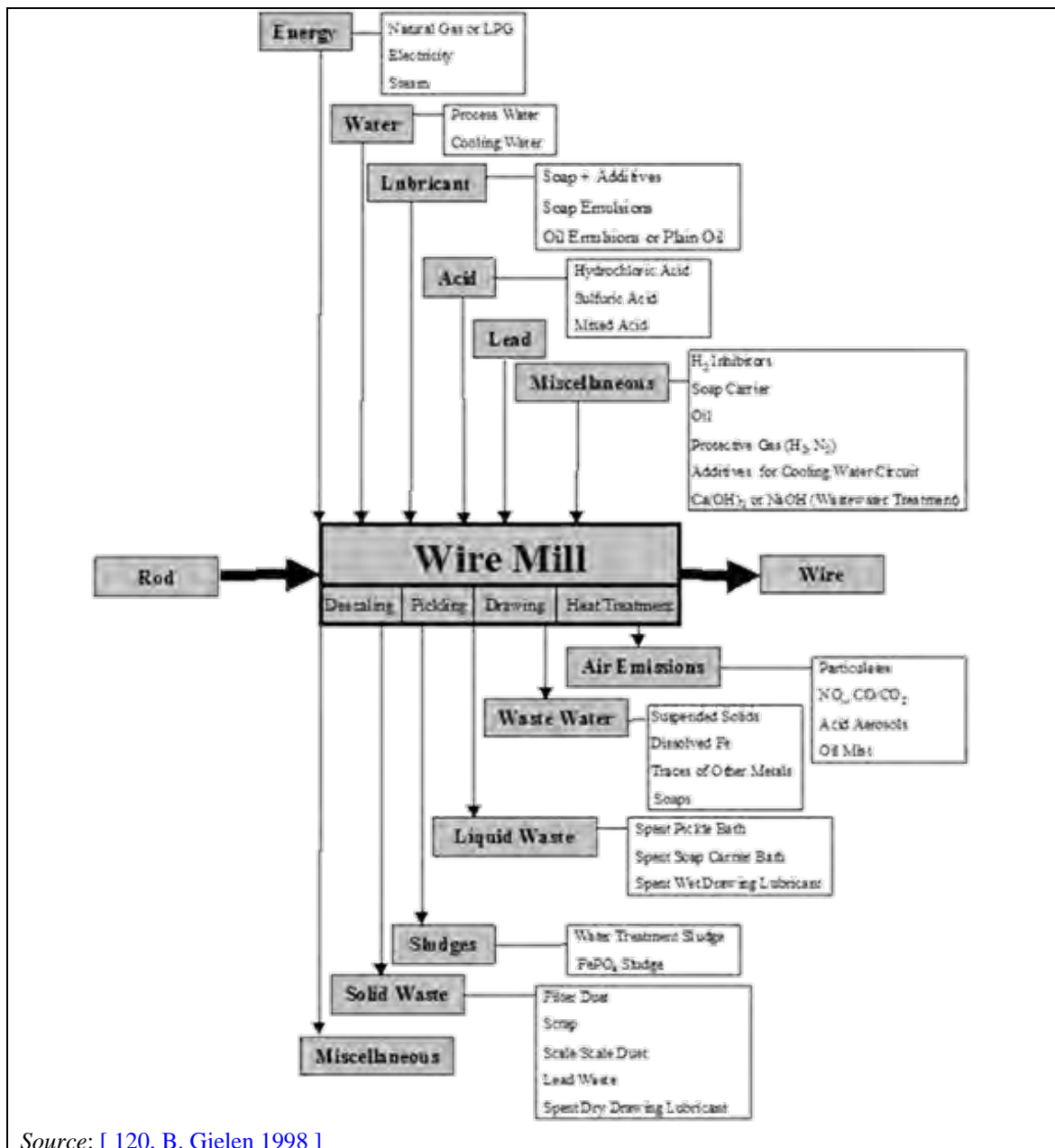


Figure 4.3: Input/output balance for a wire drawing mill

The following sections present the consumption and emission data reported by the wire production plants (wire rod preparation, drawing, heat treatment process steps) across the EU that took part to the 2018 FMP data collection (in total 7 plants). The plants from the data collection are listed in Section 11.1.

4.3.2 Energy consumption

During the data collection, information was reported about the specific energy consumption (i.e. MJ of energy consumed per total amount of feedstock processed expressed in t/year). This section focuses in particular on the energy consumption for wire drawing. For wire drawing, 5 plants provided data on the specific energy consumption in their respective production lines. The specific energy consumption data ranged from 39 MJ/t to approximately 1 062 MJ/t. Figure 4.4 shows the reported yearly specific energy consumption for wire drawing for each production line.

4.3.3 Material consumption

4.3.3.1 Consumption of acids

In total, only 2 plants reported data on the specific HCl consumption for three operating years in wire drawing plants. The values reported were below 0.5 kg of 33-wt% acid per m² of treated (pickled) surface.

4.3.4 Water consumption

Figure 4.5 shows the data reported on the specific water consumption, at plant level, for three operating years in wire drawing plants of the data collection. The specific water consumption ranged from 0.1 m³/t to 6.0 m³/t for these 5 plants. A definition of the specific water consumption can be found in Section 9.4.4.2.

4.3.5 Emissions to air

4.3.5.1 Emissions to air from dry drawing

Dust emissions

From the drawing activity, soap dust arises, which can be controlled by proper encapsulation and filtering of the extracted air. [120, B. Gielen 1998]. The reported data on dust emissions to air from dry drawing are shown in Figure 4.6. The figure shows the measurements reported by 3 plants over the three reporting years. The emissions of dust were reported for 13 emission points in total. The emission concentrations ranged from 0.4 mg/Nm³ to 61.8 mg/Nm³ and the emission loads ranged from 0.002 kg/h to 0.6 kg/h.

4.3.5.2 Emissions to air from heating

In a wire drawing plant, three types of furnaces may generate emissions to air including annealing furnaces (batch and continuous) and patenting furnaces.

Batch annealing

Emissions from batch annealing furnaces comprises the combustion products from the firing and a small flow of the protective atmosphere (purge) containing decomposition products of the lubricant. These are formed by pyrolysis/cracking of the lubricant molecules; typical decomposition products are low molecular weight olefins and alkanes.

Continuous annealing

Continuous annealing in a lead bath is composed of a lead bath followed by quenching in water. Emissions to air occur in form of dust (bath cover material, including small amounts of Pb) and soap pyrolysis products (VOC, CO, etc.). [\[121, Gielen 1999 \]](#)

Patenting

For a patenting line consisting of a furnace with direct contact between wire and combustion gases, a lead bath and a quench bath, wastes and emissions are as follows:

Air emissions arise from the furnace. The furnace is heated to 850 – 1 000 °C using natural gas (or a similar sulphur-free fuel) and with a slight O₂-shortage. Fresh air is mixed with the hot exhaust gas of the oven in order to convert CO into CO₂, prior to emission into the atmosphere. NO_x and SO₂ are negligible in this stream: reducing atmosphere/fuel is free of sulphur. The lead bath is used for cooling; in contrast to a lead bath used for annealing, there is no burning of residual lubricant, so the emissions to air are limited to dust (bath cover material, containing traces of Pb). [\[121, Gielen 1999 \]](#)

Dust emissions

The reported data on dust emissions to air from feedstock heating (annealing) are shown in Figure 4.7. The figure shows the measurements at 3 % O₂ level, reported by 2 plants over the three reporting years. The emissions of dust were reported for 3 emission points in total. The dust emission concentrations ranged from 4.0 mg/Nm³ to 35.2 mg/Nm³ and the emission loads ranged from 1.1 kg/h to 19.1 kg/h. [\[16, FMP TWG 2018 \]](#)

SO₂ emissions

The reported data on SO₂ emissions to air from feedstock heating (annealing) are shown in Figure 4.8. The figure shows the measurements at 3 % O₂ level, reported by 1 plant over the three reporting years. The emissions of SO₂ were reported for 2 emission points in total. The emission concentrations values reported were 2.0 mg/Nm³ and 4.3 mg/Nm³ and the emission loads were 1.0 kg/h to 4.0 kg/h, respectively. [\[16, FMP TWG 2018 \]](#)

NO_x and CO emissions

The reported data on NO_x and CO emissions to air from feedstock heating (annealing) are shown in Figure 4.9. The figure shows the NO_x and CO measurements at 3 % O₂ level, reported by 3 plants over the three reporting years. For Plant 301 WD1 (patenting furnace), very low NO_x emissions were reported (below 10 mg/Nm³) and CO emissions range from 190 mg/Nm³ to 240 mg/Nm³. For plants 24 WD and 301 WD2 (batch annealing), NO_x emissions ranged from 140 to 260 mg/Nm³ and CO emissions ranged from 160 mg/Nm³ to 240 mg/Nm³. [\[16, FMP TWG 2018 \]](#)

4.3.5.3 Emissions to air from pickling**HCl emissions**

Aerosols (small HCl or H₂SO₄ particles) can form mechanically when the wire rod is allowed to drip off. Furthermore, fumes evaporate from the HCl bath and H₂ can form unless suppressed by an inhibitor. Acid fumes from the baths are evacuated. Sometimes scrubbing is needed, depending on the type of acid and concentration. [\[120, B. Gielen 1998 \]](#)

Continuous annealing in a lead bath is followed by continuous pickling in a HCl bath. Due to the short residence time, heated and concentrated HCl is used. HCl fumes are removed by scrubbing from the gaseous outlet streams of the HCl bath. [\[120, B. Gielen 1998 \]](#), [\[121, Gielen 1999 \]](#)

The reported data on HCl emissions to air from pickling of wire rod are shown in Figure 4.10. The emissions of HCl were reported for 4 emission points in total, with a total of 27

measurements. The emission concentrations ranged from 1.3 mg/Nm³ to 24.4 mg/Nm³ and the emission loads ranged from 0.05 kg/h to 0.3 kg/h. [\[16, FMP TWG 2018 \]](#)

4.3.6 Emissions to water

Continuous annealing and patenting

Waste waters arise from rinsing water from the rinsing cascade after the HCl bath and from the scrubber. [\[120, B. Gielen 1998 \]](#), [\[121, Gielen 1999 \]](#)

When molten lead baths are used for patenting or continuous annealing of steel wires in the wire drawing sector, the generation of an acidic wastewater stream containing relatively high concentrations of lead is unavoidable. Essentially, small quantities of lead are dragged out from the lead bath, even when a technique aiming at minimising the carry-over of lead (See Section 4.4.6.2) is fully implemented. As a result, lead concentrations ranging from 0.5 to 5 mg/l in the downstream pickling bath and spent hydrochloric acid solutions are observed. Further drag out of pickling solutions with the wires to the rinsing cascade generally results in an acidic wastewater with lead concentrations ranging from 10 to 100 mg/l at flow rates ranging from 100 to 1000 l/h, depending on the number of wires and wire diameters. These acidic wastewaters are treated together with all other acidic wastewaters in a common wastewater treatment plant. Typically, the removal of lead (and other trace metals) is done by adjusting the pH value of the wastewater to values ranging from 8 to 10 in order to precipitate the lead (and other trace metals) as hydroxides, which also have a relatively low solubility at this pH range.

In the data collection, lead emissions to water coming from wire drawing processes where lead is used (i.e. lead baths) have been reported by plant 301WD and plant 24WWP, with a range of lead concentrations from 3 up to 200 µg/l and from 9 to 96 µg/l, respectively.

For wire drawing plants using lead baths, the use of alkaline chemicals such as NaOH or Ca(OH)₂ can typically reduce the concentration of lead to 200 – 300 µg/l, but, in combination with excess coagulants, this concentration can be further reduced to 20 – 40 µg/l. [\[122, R. Grommen 2020 \]](#)

Cooling water

When dry drawing is applied, traces of soap may contaminate the cooling tower blow down, if the drawing machine is not well maintained. [\[120, B. Gielen 1998 \]](#) Cooling water contamination occurs much less frequently with wet drawing machines than with dry drawing machines. The cooling water from batch annealing is not contaminated and can be used for cooling of some parts of the furnace. [\[118, B. Gielen, Bekaert 1998 \]](#), [\[120, B. Gielen 1998 \]](#)

All the data related to emissions to water from WD processes are presented in Section 7.2.1 of the document where figures depicting emissions to water for all sectors are presented in a merged format.

4.3.7 Residues

Mechanical descaling

Mechanical descaling generates solid waste: scale, mainly consisting of iron oxide (FeO and Fe₃O₄) plus traces of other metal oxides, depending on the alloy elements and impurities in the wire rod. The most common wire descaling technique (i.e. wire bending) generates a relatively coarse scale with only negligible amounts of dust.

Sanding, brushing and shot blasting equipments generate a relatively fine scale and are fitted with a filter system to capture scale dust. When shot blasting is used, the scale is mixed with the fraction of the shot blasting media that is not recovered.

Scale is not contaminated with oil or water, in contrast to what is generally the case in the strip industry. Very fine scale (e.g. filter dust) represents a fire or explosion hazard.

Chemical descaling/pickling

In chemical descaling liquid waste is generated in the form of spent HCl or H₂SO₄ acid [120, B. Gielen 1998] Liquid waste generated are spent acids, partially converted to metal salts and contaminated by iron, lead, traces of other metals and inorganic suspended solids. [120, B. Gielen 1998], [121, Gielen 1999]

Application of soap carrier

When Zn-PO₄ coating is used, a thick FePO₄ sludge or cake is formed containing traces of zinc, soluble phosphates and chlorate or nitrite coming from the Zn-PO₄ bath. Also, spent soap carrier may arise as liquid waste. [120, B. Gielen 1998]

Dry drawing

Dry drawing activities leave spent lubricant, mainly consisting of the drawing soap itself (typically alkali-salt of natural fatty acid + additives) contaminated by degradation products, caused by heating of lubrication in the dies, soap carrier and metal particles, like Fe or Zn depending on the surfaces of the wire). Furthermore, waste arises in from broken dies. [120, B. Gielen 1998]

Wet drawing

Wet drawing is done in a watery emulsion of soap or oil. This emulsion is gradually contaminated by dragin of various products from previous process steps, by dissolution or abrasion of metal from the wire surface (Fe or other metals if the wire is coated in a previous step), and by thermal or biological degradation. The result is that the wet drawing lubricant needs to be replaced from time to time; the replacement frequency can be lowered by continuous removal of some of the contaminants by decantation or filtration.

Other waste streams are broken dies and cooling tower blowdown, which could be contaminated by traces of emulsion if the heat exchanger is not properly maintained.

Continuous annealing

Continuous annealing in a lead bath is composed of a lead bath followed by quenching in water. This process leads to solid wastes in the form of lead oxides and lead contaminated bath cover material. Waste water is formed as overflow of the quench bath; this stream contains some of Pb. Emissions to air occur in form of dust (bath cover material, including small amounts of Pb) and soap pyrolysis products (VOC, CO, etc.). [121, Gielen 1999]

Patenting

In patenting, a solid waste is generated by the lead bath as lead oxides and spent bath cover material. [121, Gielen 1999]

Table 4.2 shows the reported data on the specific generation of spent HCl, scale and scrap for three operating years in wire drawing plants.

Table 4.2: Specific generation of residues in wire drawing plants

Residue	Specific generation in kg/t
Spent pickling liquor HCl	41-47
Scale	2.4
Scrap	1.8
<i>Source:</i> [16, FMP TWG 2018]	

4.3.8 Figures with consumption and emission levels

Energy, material and water consumption data were considered confidential business information (CBI) by the plant operators. In order to maintain data confidentiality, plant names are not directly mentioned in the graphs but are replaced by anonymised and randomly attributed CBI codes. In addition, no contextual information (e.g. process parameters or techniques applied) is included as this could reveal the identity of the plants. All the consumption figures are presented in ascending order of the maximum specific energy consumption values.

The figures related to emissions to air which are presented here are composed of several sections. The upper part of the figure shows all the measurements reported by the plants over the three reporting years and the corresponding mass flows. For combustion processes, the plotted concentration values always refer to an oxygen reference level of 3 %. Below the x-axis, additional contextual information is included such as for example the emission point code, the frequency of monitoring, the steel category, the drawing speed, the temperature of annealing. Information on the BAT candidates used is also included in the graphs. For combustion processes (annealing), the type of fuel used is included when available. In the case of figures related to NO_x emissions, the corresponding emissions of CO are also plotted. In all cases, the figures are sorted in ascending order of the maximum concentration values for the three operating years. The explanations for the abbreviations used in the graphs can be found in the glossary.

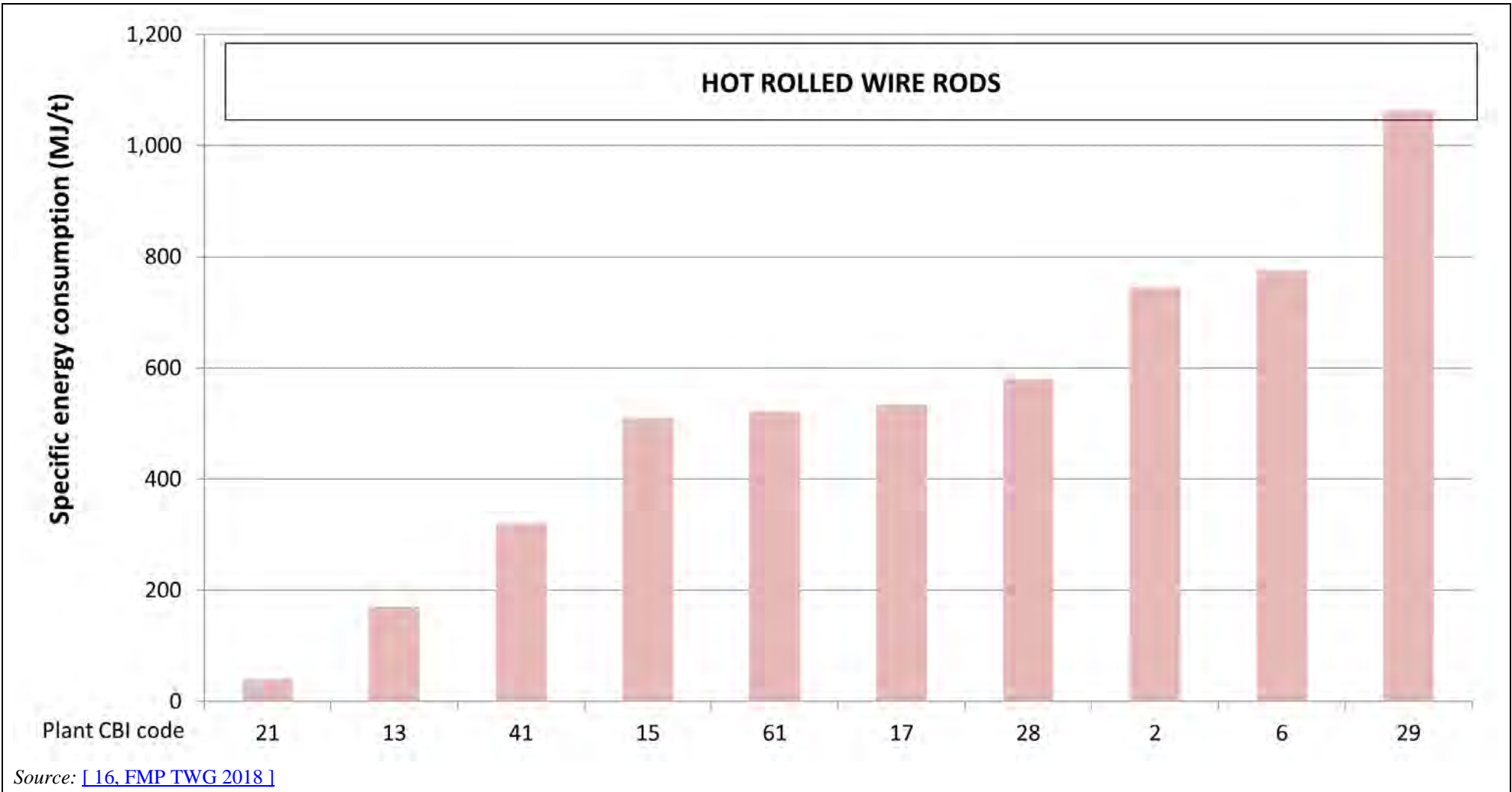


Figure 4.4: Specific energy consumption (MJ/t of feedstock processed) for wire drawing

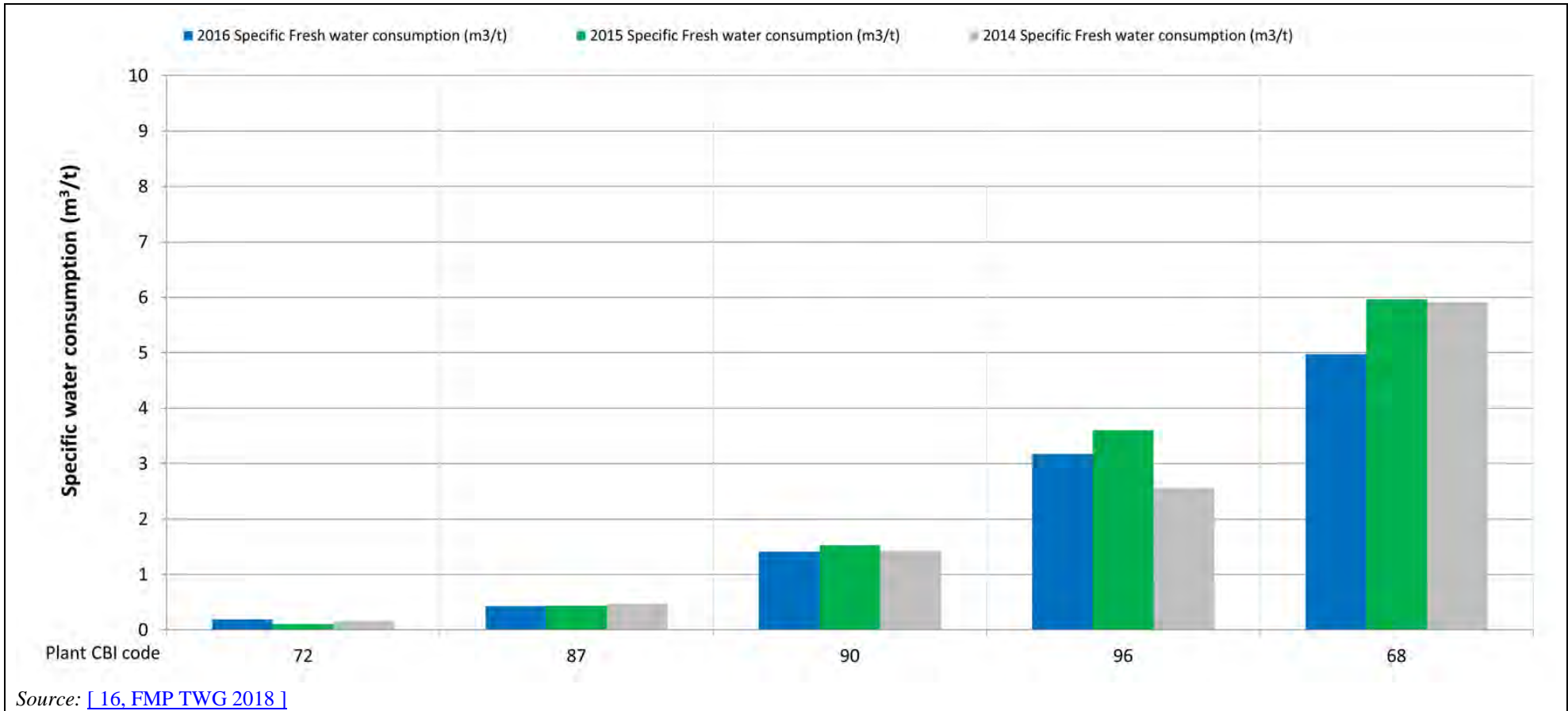


Figure 4.5: Specific water consumption (m³/t of production) in wire drawing plants

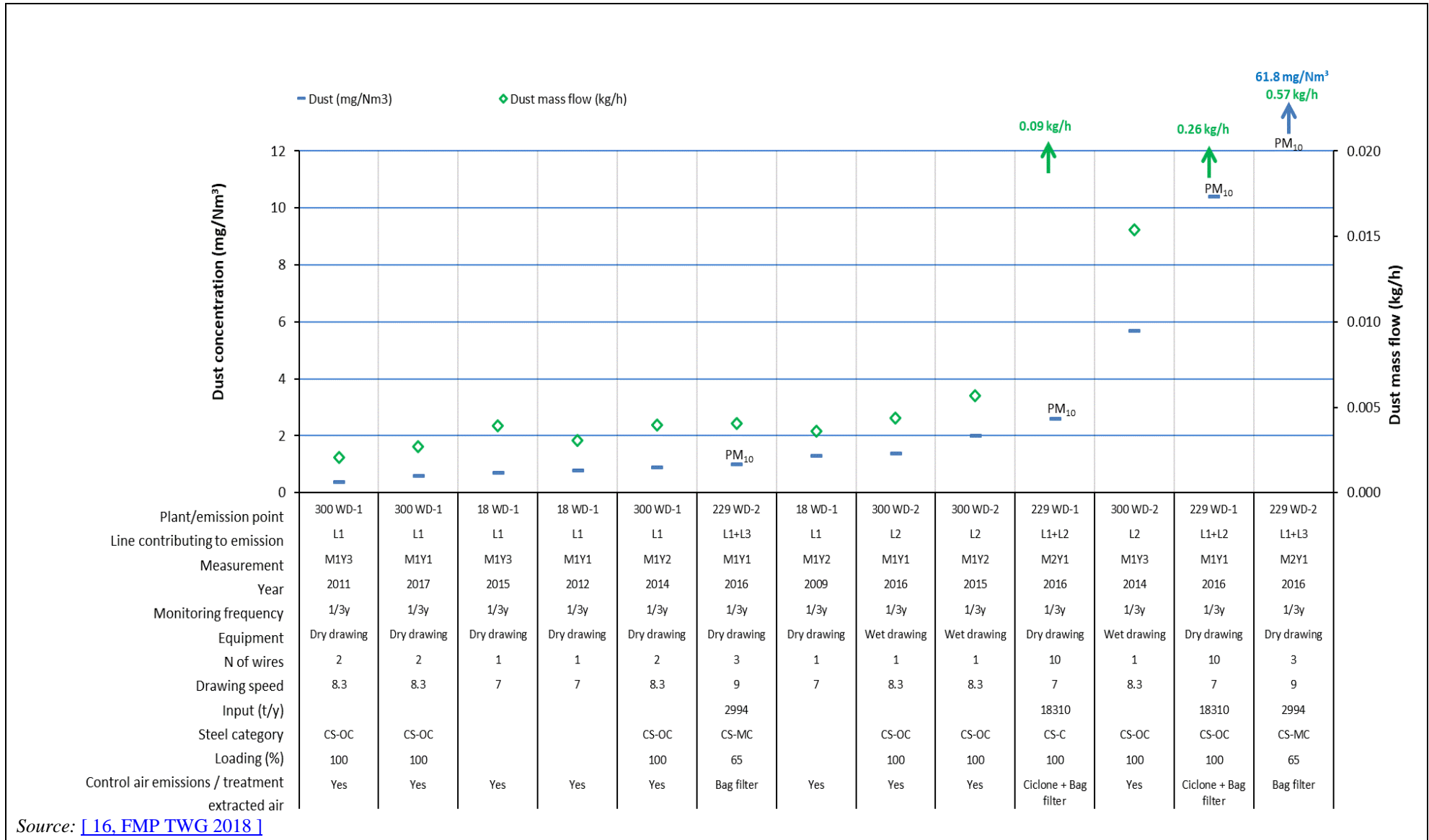


Figure 4.6: Dust emissions from wire drawing (wet and dry drawing)

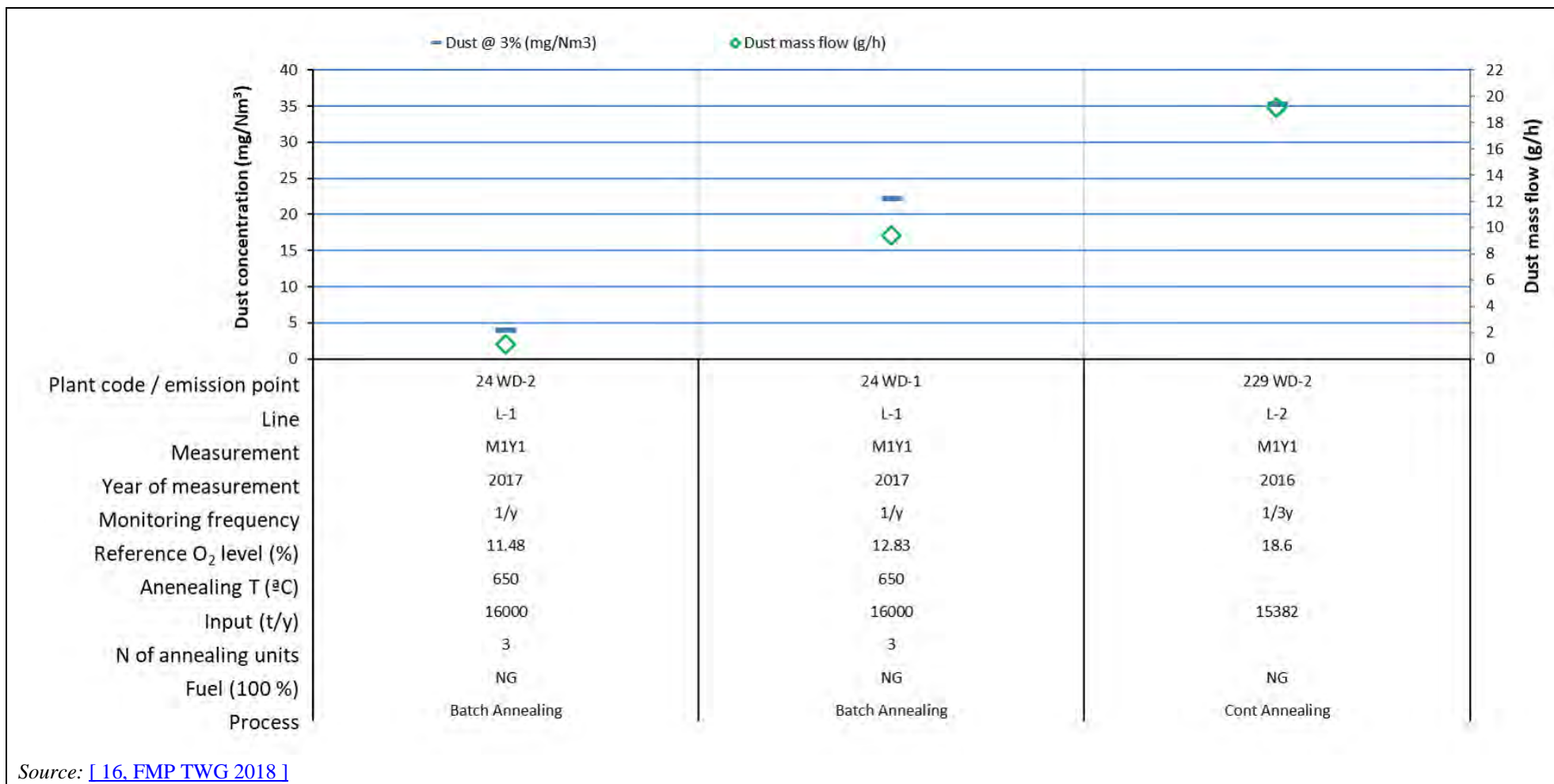


Figure 4.7: Dust emissions from feedstock heating

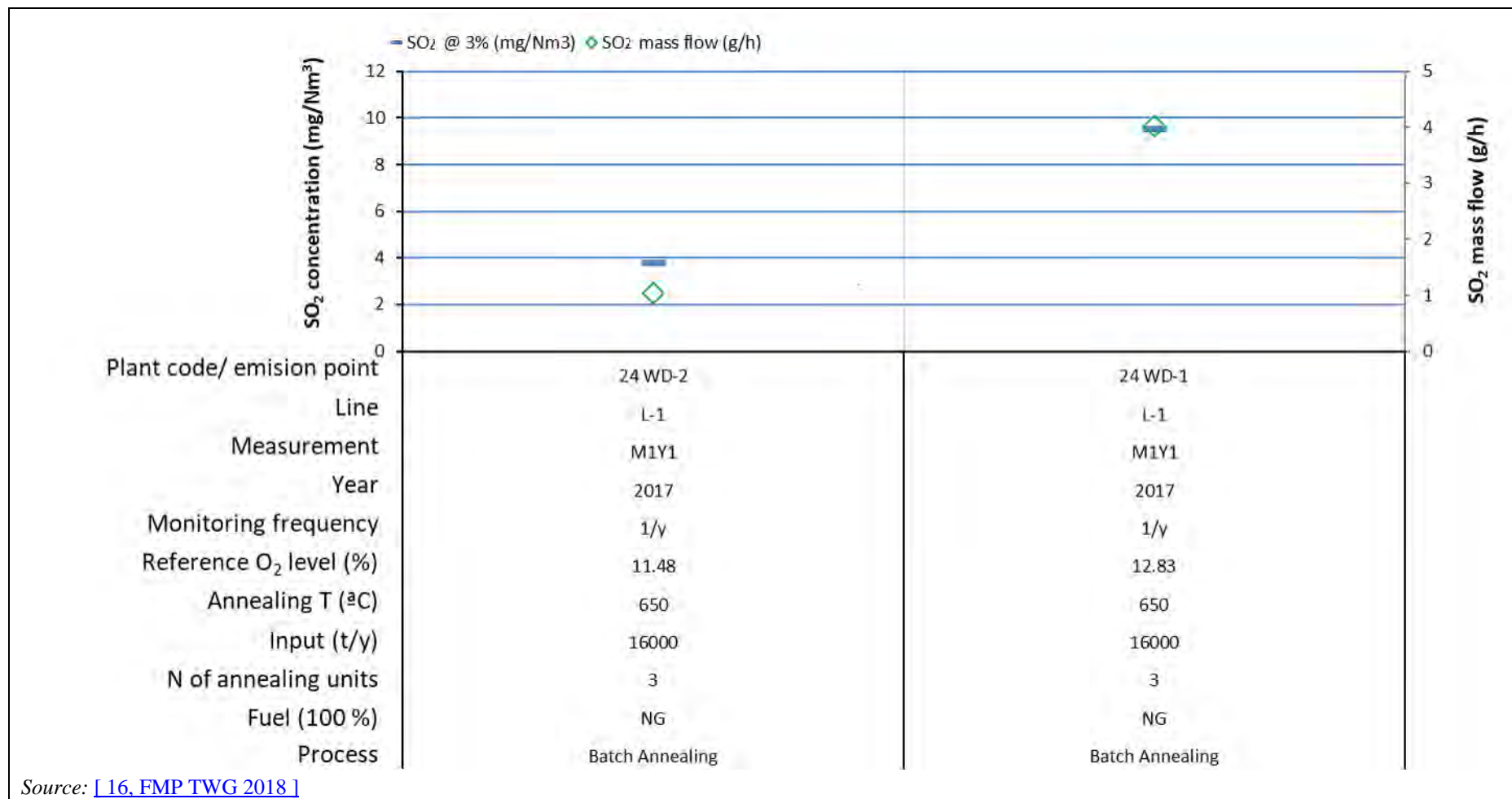


Figure 4.8: SO₂ emissions from feedstock heating

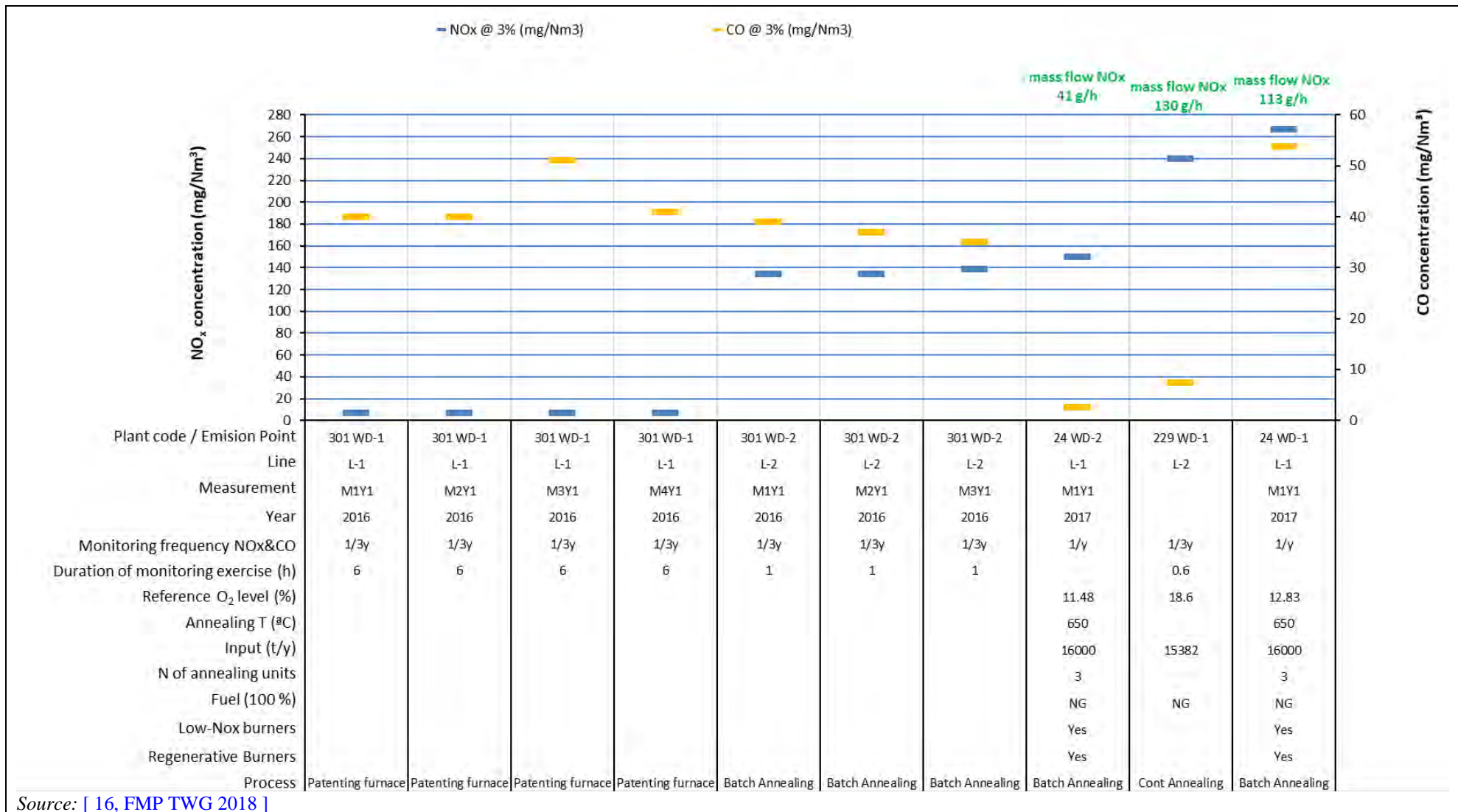
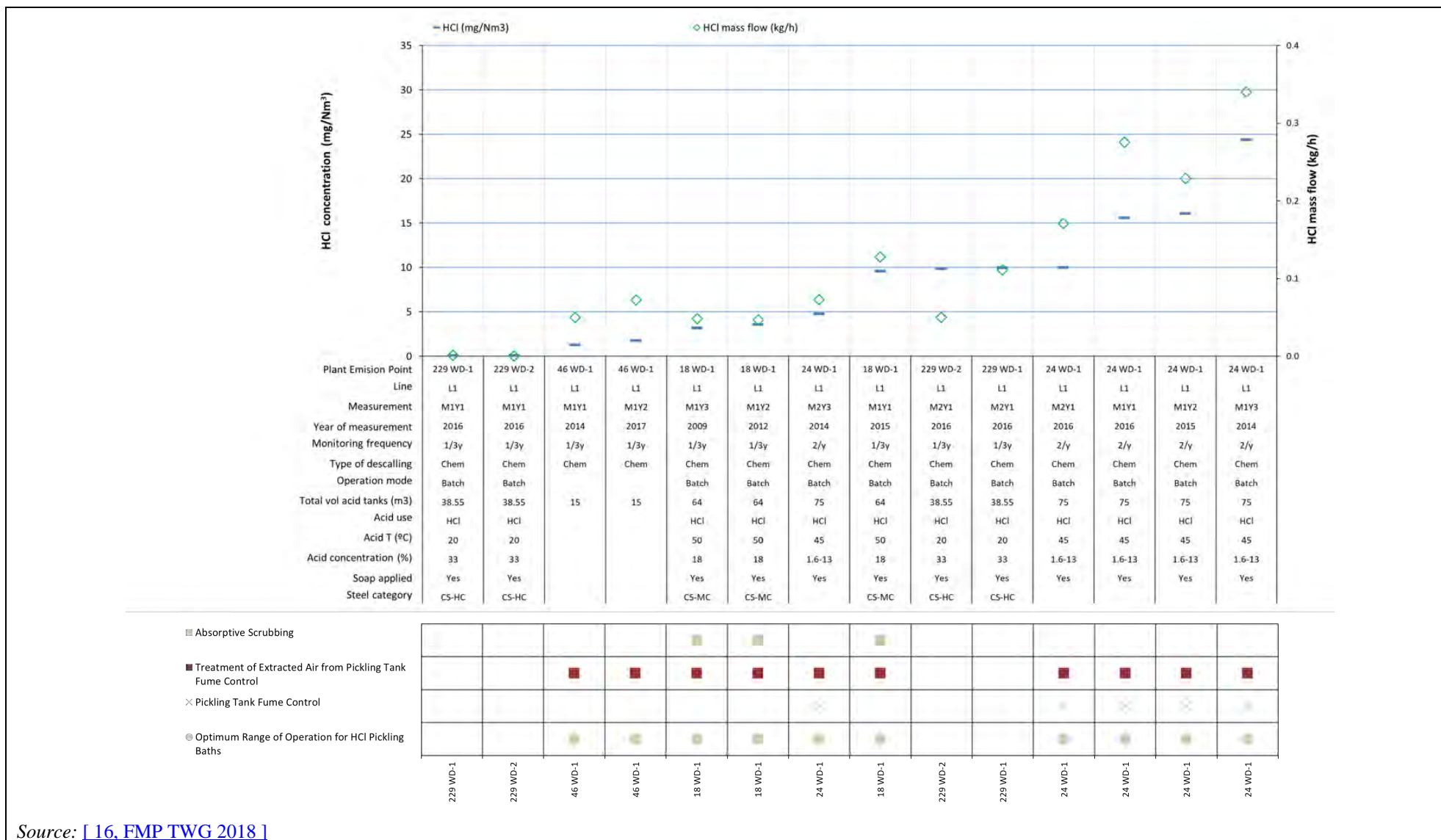


Figure 4.9: NOx and CO emissions from feedstock heating



Source: [16. FMP TWG 2018]

Figure 4.10: HCl emissions from pickling of wire rod (in mg/Nm³) in wire drawing plants

4.4 Techniques to consider in the determination of BAT for wire drawing

This section describes techniques (or combinations thereof), and associated monitoring, considered to have the potential for achieving a high level of environmental protection in the activities within the scope of this document. The techniques described will include both the technology used and the way in which the installations are designed, built, maintained, operated and decommissioned.

It covers environmental management systems as well as process-integrated and end-of-pipe techniques. Waste prevention and management, including waste minimisation and recycling procedures, are also considered, as well as techniques that reduce the consumption of raw materials, water and energy by optimising use and reuse. The techniques described also cover the prevention or limiting of the environmental consequences of accidents and incidents. They also cover the prevention or reduction of emissions under other than normal operating conditions (such as start-up and shutdown operations, leaks, malfunctions, momentary stoppages and the definitive cessation of operations).

Annex III to the Directive lists a number of criteria for determining BAT, and the information within this chapter will address these considerations. As far as possible, the standard structure in Table 2.15 is used to outline the information on each technique, to enable a comparison of techniques and the assessment against the definition of BAT in the Directive.

This chapter does not necessarily provide an exhaustive list of techniques that could be applied in the sector. Other techniques may exist, or may be developed, which could be considered in the determination of BAT for an individual installation.

In Chapter 8 general techniques (i.e. those used that are commonly used) are discussed which might also be applicable to wire drawing. These techniques are normally not repeated in this section, unless information specific for this sector was made available.

4.4.1 Mechanical descaling

4.4.1.1 Recycling of scale

Description

Scale collected during mechanical descaling by reverse bending is recycled to the iron and steel production to recover the iron content; scale from shot blasting requires separation of scale and shot blast material before recycling (see Section 4.4.1.2).

Technical description

The bulk of descaling in the wire industry is done by reverse bending, leading to a scale which consists mainly of metal oxides and which is oil- and water-free. Due to bending and torsion of the wire, the scale breaks down and drops into collection containers. All wire companies can keep the scale separated from other waste streams to allow recovery of the iron content by recycling to the primary iron and steel industry. Whether recycling is done or not depends to a large extent on the interest of the local steel industry, which has little to gain by the recycling of this small amount of rather difficult to handle secondary raw material. [\[118, B. Gielen, Bekaert 1998 \]](#)

In some exceptional cases where abrasives are used (e.g. shot blasting, sanding), scale gets mixed with other products. Recovery of shot blasting media from scale is a common practice with both economical (less consumption) and environmental (less waste) benefits. Infinite recovery is not possible and not desired (quality loss, higher degree of dust formation).

[\[118, B. Gielen, Bekaert 1998 \]](#)

Achieved environmental benefits

Reduction of waste. [\[118, B. Gielen, Bekaert 1998 \]](#)

Environmental performance and operational data

No information provided.

Cross-media effects

None.

Technical considerations relevant to applicability

- Generally, there are no technical restrictions to the applicability of this technique.
- Technically possible for all scale from mechanical descaling of wire (rod).
- Limitation of recycling not due to technical factors, but due to acceptance by the potential recycler. [\[118, B. Gielen, Bekaert 1998 \]](#)

Economics

No information provided.

Driving force for implementation

Increased material efficiency.

Example plants

Plant from the data collection: Plant 300 WD.

Reference literature

[\[16, FMP TWG 2018 \]](#), [\[118, B. Gielen, Bekaert 1998 \]](#).

4.4.1.2 Recovery and reuse of shot blast media

Description

Where mechanical descaling is carried out by shot blasting, the shot blast media are separated from the scale and reused.

Technical description

Shot blasting is possible as in-line or bulk processing. It involves the propulsion of thousands of steel shot particles per second, towards the surface of the material. This causes the scale to break and fall off the base metal. The shot blast or blast cleaning system consists of the following:

- a cabinet to house and contain the descaling operation;
- a series of blast wheels of varying power depending on required line speeds, production requirements, etc.;
- a reclaim system to return used shot or media to a recycling system;
- a recycling system where media is cleaned and small particles of dust and scale are removed;
- a storage area within the system where shot is stored before being distributed once again to the blast wheels;
- a dust collection system.

The blast cabinet is a confined enclosure where the blast descaling operation takes place. A series of blast wheels are mounted to the cabinet and propel the media, usually steel shot, by centrifugal force towards the wire.

The reclaim system provides a means to retrieve the used shot and dust from the descaling operation and brings it to the recycling system.

Recycling of the shot media involves separating the good reusable media from the contaminants and dust gathered in the mix. By passing the collected media through an air wash separator, the fine dusts and smaller contaminants are drawn from the system by a vacuum effect, leaving the cleaned shot particles to be returned to a storage system. From this storage system, the media will be distributed through a series of controls or valves back to the blast wheels. By synchronising the entire system, a continuous flow of media is directed toward the wire to achieve the desired results in the fastest and most expedient manner.

Stream descaling

This method involves predescaling of wire rod by bending and torsion and fluidisation of the scale obtained in this descaling. In a special chamber the fluidised scale is then blown onto the wire rod surface by means of jet pumps and compressed air. The rod is descaled to its metallic surface. The scale is transported to a dust collection system (cyclone, cloth filter) by the compressed air. Coarse scale is returned to the jet pumps and used again. The fine scale is utilised as a component in the production of paints.

This method is reported to be applicable to low-carbon steel wire rod and high-carbon steels. Another advantage is that no other media as shot or grit is needed.

Achieved environmental benefits

- Scale is collected separately and can be reused.
- Consumption of shot blasting media is reduced.

Environmental performance and operational data

No information provided.

Cross-media effects

None.

Technical considerations relevant to applicability

Generally, there are no technical restrictions to the applicability of this technique.

Economics

Initial investment costs and space requirements are reported to be very low.

Driving force for implementation

Material efficiency.

Example plants

Stream descaling: Wire Factory in Gliwice, Poland application low-carbon wire, reduced production costs.

Reference literature

No reference literature provided.

4.4.2 Chemical descaling / Pickling of wire rod

4.4.2.1 Control of pickling emissions

Chemical pickling of wire rod is mostly done in batch operation. In some cases, in-line pickling is also carried out.

In the case of batch pickling, the general techniques to control acid emissions from pickling tanks that are described in Section 8.8.4 apply including:

- batch pickling in tanks equipped with lids or enclosing hoods combined with fume extraction (Section 8.8.4.1);
- wet scrubbing followed by a demister (Section 8.8.4.3).

In the case of continuous pickling, the general techniques to control acid emissions from pickling tanks that are described in Section 8.8.4 apply including:

- closed pickling tanks combined with air extraction (Section 8.8.4.2);
- wet scrubbing followed by a demister (Section 8.8.4.3).

4.4.2.2 Acid recovery

Pickling acids used in the wire drawing sector can be recovered using the general techniques described into more details in Section 8.6.5 including:

- crystallisation for H_2SO_4 ;
- evaporative recovery for HCl;
- pyrohydrolysis via spray roasting for HCl.

4.4.2.3 Reuse of spent acid as secondary raw material

Description

Spent acid can be used by the chemical industry as a secondary raw material for the production of $FeCl_3$ and, to a minor extent, for pigments.

Technical description

The chemical industry uses spent acid as a secondary raw material for the production of $FeCl_3$ and, to a minor extent, for pigments. The possibility to recycle spent acid for the production of valuable chemicals is available in many regions in Europe. Some contractors impose or have to impose strict limits for some metal impurities in the spent acids. A few contractors have recently developed and patented special processes to remove Zn or Pb for example from some types of spent acid. [[118, B. Gielen, Bekaert 1998](#)]

Achieved environmental benefits

Reduction of acidic waste.

Environmental performance and operational data

No information provided.

Cross-media effects

No information provided.

Technical considerations relevant to applicability

Generally, there are no technical restrictions to the applicability of this technique.

Economics

No information provided.

Driving force for implementation

Reduction of spent acid sent for disposal.

Example plants

Not reported in the FMP data collection.

Reference literature

[118, B. Gielen, Bekaert 1998]

4.4.3 Dry drawing

4.4.3.1 Enclosed drawing machine combined with air extraction and abatement

Description

The entire drawing machine is enclosed in order to avoid dispersion of dust and air is extracted and treated by a fabric filter.

Technical description

An enclosure or cover is installed above parts of the drawing machine that are in contact with the wire. The enclosure or cover needs to be designed in such a way that it can be removed easily for frequent tasks, such as threading a wire through the machine, fixing a broken wire, adjusting or replacing a die or adding soap. The air within the cover is extracted.

The extracted air is treated by a fabric filter to capture soap dust.

Achieved environmental benefits

Reduction of emissions to air, especially of fugitive soap dust. [118, B. Gielen, Bekaert 1998]

Environmental performance and operational data

A number of plants reported dust emission below 2 mg /Nm³ (e.g. 300 WD1, 18 WD1, 229 WD2). [16, FMP TWG 2018]

Cross-media effects

None.

Technical considerations relevant to applicability

Applicability to existing plants may be restricted by the plant layout.

Economics

No information provided.

Driving force for implementation

The goal is to limit the spread of lubricant-dust over the area around the drawing machine. Total elimination of soap dust is impossible (e.g. soap dust leaving the drawing machine with the drawn wire). This is mainly done to improve the working environment. [118, B. Gielen, Bekaert 1998]

Example plants

Plants from the data collection: 18 WD, 229 WD, 300 WD.

Reference literature

[118, B. Gielen, Bekaert 1998].

4.4.3.2 Air extraction as close as possible to the emission source for emissions from the drawing machine

Description

Emissions from the drawing machine are collected, for example using hood or lip extraction. The extracted air is treated by a fabric filter.

Technical description

When an enclosure cannot be fitted to the drawing machine, in order to collect and abate the emissions, hoods or lip extraction are used as close as possible to the emission source. The extracted air is treated by a fabric filter to capture soap dust.

Achieved environmental benefits

Reduction of emissions to air, especially of fugitive soap dust. [[118, B. Gielen, Bekaert 1998](#)]

Environmental performance and operational data

No information provided.

Cross-media effects

None.

Technical considerations relevant to applicability

Generally, there are no technical restrictions to the applicability of this technique.

Economics

No information provided.

Driving force for implementation

The goal is to limit the spread of lubricant-dust over the area around the drawing machine. Total elimination of soap dust is impossible (e.g. soap dust leaving the drawing machine with the drawn wire). This is mainly done to improve the working environment. [[118, B. Gielen, Bekaert 1998](#)]

Example plants

No information provided.

Reference literature

[[118, B. Gielen, Bekaert 1998](#)].

4.4.3.3 Closed loop for cooling water

Description

Water that is used to cool the dies and the wire is circulated in a closed loop, equipped with a wet cooling tower, an air cooler or similar device.

Technical description

The drawing operation heats both the wire and drawing die through friction of the wire. So both the dies and the wire (indirectly, through cooling of the capstans in contact with the wire) are water-cooled. In order to reuse the cooling water, the water circuit is equipped with a wet cooling tower, an air cooler or similar device. [[118, B. Gielen, Bekaert 1998](#)]

Achieved environmental benefits

Reduced water consumption.

Environmental performance and operational data

No information provided.

Cross-media effects

None.

Technical considerations relevant to applicability

Generally, there are no technical restrictions to the applicability of this technique.

Economics

No information provided.

Driving force for implementation

Reduced water consumption.

Example plants

Widely used.

Reference literature

[[16, FMP TWG 2018](#)], [[118, B. Gielen, Bekaert 1998](#)].

4.4.3.4 Use of low-borax drawing soaps

Description

Low-borax drawing soaps are used as an alternative to the classical borax drawing soaps.

Technical description

Low-borax drawing soaps, with a borax content of 6.5 wt-% or lower, are used to increase the drawing speed while minimising lubricant consumption and reducing borate emissions to water. After pickling and rinsing, the wire coils or ferrous rods are submerged in a hot bath, a 'borax bath', to acquire a protective coating. To ensure that the coating formed is composed of borax pentahydrate, the bath temperature is maintained at about 90 °C. The residence time should be kept sufficiently long to allow the wire to heat thoroughly. After this, the borate coating is either air dried or flash baked at operating temperatures around 290 °C. To extend the lifetime of the borax bath, it is important to avoid that acids from the upstream cleaning process end-up in the borax bath. Sufficient rinsing of the coils and rods after pickling is therefore essential. [[123, Van Den Abeele L. 2017](#)]

Achieved environmental benefits

Reduction of losses of borates and emissions of borate to waste water.

Environmental performance and operational data

No information provided.

Cross-media effects

Increased water consumption for rinsing before the borax bath.

Technical considerations relevant to applicability

- Generally, there are no technical restrictions to the applicability of this technique.
- The low-borax drawing soaps can be used in most of the wire drawing processes.

Economics

The prices of low-borax drawing soaps is comparable with the traditional drawing soaps.

Driving force for implementation

The low-borax soaps are outside the scope of the REACH legislation.

Example plants

Bekaert wire drawing plant (Belgium): Plant 24 WD.
Plant 301 WD.

Reference literature

[\[16, FMP TWG 2018 \]](#), [\[123, Van Den Abeele L. 2017 \]](#).

4.4.4 Wet drawing**4.4.4.1 Closed loop for cooling water****Description**

Heat is generated during drawing. Most of the heat is transferred to the lubricant which is cooled using cooling water.

Technical description

The drawing operation heats both the wire and drawing die through friction of the wire. This heat is taken up by the lubricant. The lubricant in turn is cooled; often this is done indirectly with cooling water. [\[118, B. Gielen, Bekaert 1998 \]](#)

Achieved environmental benefits

Reduced water consumption.

Environmental performance and operational data

No information provided.

Cross-media effects

None.

Technical considerations relevant to applicability

Generally, there are no technical restrictions to the applicability of this technique.

Economics

No information provided.

Driving force for implementation

Reduced water consumption.

Example plants

Plant from the data collection: 300 WD2.

Reference literature

[\[16, FMP TWG 2018 \]](#), [\[118, B. Gielen, Bekaert 1998 \]](#).

4.4.4.2 Cleaning of drawing lubricant / coolant**Description**

A cleaning circuit, e.g. with filtration and/or centrifugation, is used to clean the wire-drawing lubricant for reuse.

Technical description

Wire drawing lubricants, water-miscible oil emulsions or straight oils accumulate metal fines during operation. As the contents of fines increases, operational problems develop, such as wire-drawing breaks, capstan wear and poor quality of wire, requiring replacement of the lubricant. Media filtration and/or centrifuges are used to clean the lubricant and to prolong the lifetime. [\[124, El-Hindi et al. 1999 \]](#)

Achieved environmental benefits

Reduction of waste drawing lubricant. [\[124, El-Hindi et al. 1999 \]](#)

Environmental performance and operational data

Cleaning of drawing lubricant can improve the operational behaviour as it reduces wire-drawing breaks and improves the wire quality (thus also reducing operational problems downstream). [[124, El-Hindi et al. 1999](#)]

Cross-media effects

Generation of waste filter media. [[124, El-Hindi et al. 1999](#)]

Technical considerations relevant to applicability

Generally, there are no technical restrictions to the applicability of this technique.

Economics

No information provided.

Driving force for implementation

Increased material efficiency.

Example plants

Widely used.

Reference literature

[[16, FMP TWG 2018](#)], [[124, El-Hindi et al. 1999](#)].

4.4.4.3 Treatment of waste drawing lubricant: oil and oil emulsions

Description

The organic phase is separated from the aqueous phase, e.g. by skimming or by emulsion splitting with suitable agents, evaporation or membrane filtration. The organic phase may be used for other purposes (e.g. as a fuel).

Technical description

See Section 8.9.14.

Achieved environmental benefits

- Reduced disposal volume.
- In case of incineration, thermal utilisation of waste.

Environmental performance and operational data

Reduced waste disposal costs.

Cross-media effects

None.

Technical considerations relevant to applicability

Generally, there are no technical restrictions to the applicability of this technique.

Economics

No information provided.

Driving force for implementation

Reduction of waste water contamination.

Example plants

Widely used.

Reference literature

No reference literature provided.

4.4.4.4 Treatment and disposal of waste drawing lubricant: soap emulsions

Description

If the quantities are small, the spent lubricant is mixed with other waste waters. If the quantities are comparably significant, the spent lubricants are treated separately by coagulation and precipitation, coagulation and flotation, membrane filtration, evaporation or any other suitable methods.

Technical description

For soap emulsions based on a fatty acid alkali soap, the treatment depends on the amount of waste lubricant. If the quantities are small compared to other waste waters of the plant, the spent lubricant is mixed with other waste waters. The soaps are bounded in the filter cake during almost all existing water treatment methods for acidic waste waters. If a biological treatment is used, the fatty acid soaps are easily biodegradable. [[118, B. Gielen, Bekaert 1998](#)]

If the quantities are comparably big, the spent lubricants are treated separately by coagulation and precipitation, coagulation and flotation, membrane filtration, evaporation or other suited methods. [[118, B. Gielen, Bekaert 1998](#)]

Achieved environmental benefits

Reduced emissions to water.

Environmental performance and operational data

No information provided.

Cross-media effects

Generation of sludge and filter cake from water treatment.

Technical considerations relevant to applicability

Generally, there are no technical restrictions to the applicability of this technique.

Economics

No information provided.

Driving force for implementation

Reduction of waste water contamination.

Example plants

No information provided.

Reference literature

[[118, B. Gielen, Bekaert 1998](#)].

4.4.5 Batch annealing of wire

4.4.5.1 Burn purge of protective gas

Description

The fraction of the protective gas that is continuously purged contains decomposition products of the lubricants and in some types of protective gases combustible components, which are converted to less harmful products in an open flame.

Technical description

In order to keep an over-pressure in the 'pots' or 'bells', a fraction of the protective gas is continuously purged. This gas stream contains, apart from the components of the actual

protective gas, decomposition products of the lubricant. These are formed by pyrolysis/cracking of the lubricant molecules; typical decomposition products are low molecular weight olefins and alkanes.

These volatile organic components and the combustible components in some types of protective gases (CO, H₂) should be converted to less harmful products. As the purge is a very small flow of combustible gas, this is simply done in an open flame. [[118, B. Gielen, Bekaert 1998](#)]

Achieved environmental benefits

Reduced emissions to air.

Environmental performance and operational data

No information provided.

Technical considerations relevant to applicability

Generally, there are no technical restrictions to the applicability of this technique.

Cross-media effects

No information provided.

Economics

No information provided.

Driving force for implementation

Environmental legislation.

Example plants

Widely used.

Reference literature

[[118, B. Gielen, Bekaert 1998](#)]

4.4.6 Continuous (in-line) annealing of low-carbon wire

4.4.6.1 Floating protective layers or tank covers on the surface of the lead baths

Description

Floating protective layers and tank covers on the surface of the lead baths are used to minimise heat losses lead oxidation and reduce emissions to air.

Technical description

A floating protective layer (particulate material) or cover is maintained on the surface of the lead bath to minimise loss of lead by oxidation, drastically reduce energy losses of the bath and reduce emissions to air of dust and lead.

Achieved environmental benefits

- Increased energy and material efficiency.
- Reduction of dust and lead emissions.

Environmental performance and operational data

No information provided.

Cross-media effects

None.

Technical considerations relevant to applicability

Generally, there are no technical restrictions to the applicability of this technique.

Economics

No information provided.

Driving force for implementation

Reduction of lead emissions in the workplace.

Example plants

Widely used.

Reference literature

[118, B. Gielen, Bekaert 1998].

4.4.6.2 Minimisation of carry-over of lead**Description**

Techniques include the use of anthracite gravel to scrape off lead and the coupling of the lead bath with in-line pickling.

Technical description

- Prevent formation of dust while removing impurities from the lead bath.
- Minimise drag-out of lead with the wire by maintaining a suitable surface condition on the half-product (both economically and environmentally attractive).
- Minimise drag-out of lead with the wire by using an anthracite gravel wipe or similar immediately after the lereverad bath.
- Apply a method that minimises/eliminates the spread of lead dust that is possibly dragged out with the wire. In many production lines, this is done by coupling the in-line heat treatment to in-line pickling. Other methods include coating of the wire with a suitable product or adapted packaging of the wire. [118, B. Gielen, Bekaert 1998]

Achieved environmental benefits

Increased material efficiency.

Environmental performance and operational data

See Section 4.3.6.

Cross-media effects

When molten lead baths are used for patenting or continuous annealing of steel wires in the wire drawing sector, the generation of an acidic waste water stream containing significant concentrations of lead is unavoidable, even if the technique described in this section is implemented in combination with the two following techniques (minimisation of drag-out of pickling acid (see Section 8.6.2.9) and reverse cascade rinsing (see Section 8.7.5) [122, R. Grommen 2020]. More information on the treatment of the acidic wastewater stream containing lead is described in Section 4.3.6.

Technical considerations relevant to applicability

Generally, there are no technical restrictions to the applicability of this technique.

Economics

No information provided.

Driving force for implementation

Reduction of lead emissions in the workplace and carry-over towards subsequent production process.

Example plants

Widely used.

Plant 301 WD (direct and indirect discharges) reported lead emissions of 200 µg/l and 38 µg/l both on the same emission point 1. [[122, R. Grommen 2020](#)]

Reference literature

[[118, B. Gielen, Bekaert 1998](#)], [[122, R. Grommen 2020](#)].

4.4.6.3 Air extraction as close as possible to the source and treatment of lead bath emissions

Description

Emissions from the lead bath are collected, for example using hood or lip extraction, and are treated using a fabric filter.

Technical description

Lead bath emissions are extracted, using lip or hood extraction, and treated using fabric filter (See Section 8.8.1.3).

Achieved environmental benefits

Reduced emissions from lead bath (Pb from the bath itself, CO and TOC from incomplete burning of residues on the wire). [[118, B. Gielen, Bekaert 1998](#)]

Environmental performance and operational data

No information provided.

Cross-media effects

None.

Technical considerations relevant to applicability

Generally, there are no technical restrictions to the applicability of this technique.

Economics

No information provided.

Driving force for implementation

Environmental legislation.

Example plants

No information provided.

Reference literature

[[118, B. Gielen, Bekaert 1998](#)].

4.4.6.4 Closed-loop operation of quench bath and waste water treatment

Description

Quench baths are operated using low-quality recovered water or in a closed water loop configuration. Waste water from quenching is treated in such a way that insoluble $\text{Pb}(\text{OH})_2$ and PbCO_3 is removed prior to discharge.

Technical description

As the water quality requirements for quench baths are generally low, it is possible to use recovered water for this purpose or to operate the quench bath in closed loop. [[118, B. Gielen, Bekaert 1998](#)]

Waste water from a quench bath is treated in such a way that contamination (mainly contamination with insoluble $\text{Pb}(\text{OH})_2$ and PbCO_3) is removed prior to discharge. [118, B. Gielen, Bekaert 1998]

There are several configurations possible for the treatment of quenching water in wire drawing plants:

- Each site has to determine its own waste water treatment facility in such a way that it can handle a mix of waste waters that originates at that site. This mix is different for each site and is highly dependent on the product range of that site (use of acid or not, availability of recycling services for spent acid or not, use of wet drawing emulsions or not, use of plating baths or not and type of plating baths, etc.) and on the local environmental requirements.
- If a heat treatment without protective atmosphere is used (e.g. a heat treatment involving the use of a molten Pb bath), then also acid pickling is used. In this case, at least spent rinsing water containing acid and iron has to be treated. To do this, wire plants use a traditional physico-chemical waste water treatment, in other words neutralisation with lime milk followed by precipitation of Fe and Pb and other heavy metals, followed by decantation and filter-pressing of the cake. [125, Gielen 1999]

Achieved environmental benefits

Reduced lead emissions to water.

Environmental performance and operational data

No information provided.

Cross-media effects

Generation of waste/sludges from waste water treatment.

Technical considerations relevant to applicability

Generally, there are no technical restrictions to the applicability of this technique.

Economics

No information provided.

Driving force for implementation

Environmental legislation.

Example plants

Widely used.

Reference literature

[118, B. Gielen, Bekaert 1998], [125, Gielen 1999].

4.4.7 Patenting

4.4.7.1 Optimised operation of the oven

Description

A slightly substoichiometric mixture is used in the burners to exclude O_2 from the oven atmosphere, in order to minimise the formation of iron oxides at the wire surface. Excess CO is then converted to CO_2 by adding air in a controlled way to the hot exhaust of the oven.

Technical description

A slightly substoichiometric mixture is used in the burners. In this way, all O₂ is excluded from the oven atmosphere, in order to minimise the formation of iron oxides at the wire surface. Excessive formation of iron oxide leads to high losses of wire material and to excessive consumption of pickling acid, and leads to excessive drag-out of lead. [118, B. Gielen, Bekaert 1998]

Excess CO must be converted to CO₂ by adding air in a controlled way to the hot exhaust of the oven. The CO content of the oven atmosphere and the exhaust gas must be controlled regularly, e.g. after every major change in the product mix or at least every month. Because of the heating method, NO_x formation is not an issue. [118, B. Gielen, Bekaert 1998]

Achieved environmental benefits

- Reduced consumption in the following process steps (e.g. acid).
- Reduced CO content.

Environmental performance and operational data

No plants reported reported the use of this technique in the FMP data collection.

Cross-media effects

No information provided.

Technical considerations relevant to applicability

Generally, there are no technical restrictions to the applicability of this technique.

Economics

No information provided.

Driving force for implementation

Reduced consumption of acid in pickling.

Example plants

No example plants included in the FMP data collection.

Reference literature

[118, B. Gielen, Bekaert 1998].

4.4.8 Oil hardening and tempering

4.4.8.1 Burn purge of protective gas

Refer to Section 4.4.5.1.

4.4.8.2 Air extraction as close as possible to the emission source for emissions from oil quench baths

Description

Emissions from oil quench baths are collected, for example using lateral hood or lip extraction and are abated using a demister.

Technical description

Evacuation of the oil mist and removal of the oil mist from the extracted air.

Achieved environmental benefits

Reduction of fugitive emissions to air, especially oil emissions.

Environmental performance and operational data

No information provided.

Cross-media effects

None.

Technical considerations relevant to applicability

Generally, there are no technical restrictions to the applicability of this technique.

Economics

No information provided.

Driving force for implementation

Environmental legislation.

Example plants

No information provided.

Reference literature

No reference literature provided.

4.4.9 Heat treatment of wire (different processes)**4.4.9.1 Inductive heating of wire****Description**

The wire to be heated is guided through a coil. In this coil, a magnetic field is generated which induces an electric current in the wire. The wire is heated through the Joule effect of the induced current.

Technical description

The wire to be heated is guided through a coil in which a magnetic field is generated. Typically, applied frequencies are 5–50 kHz (mid-frequency heating). Exceptionally, high-frequency heating (well above 50 kHz) is used. This magnetic field induces an electric current in the wire which is heated through the Joule effect of the induced current. The induced current is mainly in a small layer towards the outside of the wire section; this phenomenon is called the ‘skin-effect’.

The applicability of inductive heating is highly dependent on the wire material, wire diameter and required temperature increase:

- Material is preferably magnetic.
- Steel and certain steel alloys are magnetic. Most types of stainless steel are non-magnetic. Most metal coatings are non-magnetic.
- Wire diameter is preferably high, e.g. above 2–3 mm.
- The smaller the diameter, the higher the frequency should be in order to maintain a sufficient skin-effect.
- Above the ‘Curie-temperature’, a magnetic material loses its magnetic properties. Steel loses its magnetic properties at approximately 760 °C.

Applications outside this range are available. However, expensive high-frequency equipment has to be used and energetic efficiency is on average lower.

The vast majority of the applications of inductive heating are found in single wire lines. Induction heating in a single wire line concept can be used for austenitising and tempering. Austenitising is the first step of several thermal treatment operations: patenting (see Section 4.4.7), oil hardening and tempering (see Section 4.4.8).

An exact control of the wire temperature is a necessity for these thermal treatments.

Induction heating in a multi-wire line concept can be used for preheating of the wires (e.g. to the Curie-temperature). Another application is diffusion of Cu and Zn coatings on a steel wire in order to obtain a brass-coated wire.

Achieved environmental benefits

Emissions to air from combustion are avoided in the plant.

Environmental performance and operational data

Typical electrical energy efficiencies of mid-frequency inductive heating are in the range of 60–85 %. The typical energy efficiency of a NG-based heating method for similar applications is 25–45 %. Taking into account the efficiency of NG-based electricity generation, e.g. a STAG reaching 50–55 %, one can conclude that there is hardly any difference in primary fuel consumption.

Cross-media effects

Consumption of fuel (typically NG or LPG) is replaced by consumption of electricity. When taking into account the fuel consumption of electricity generation, this cross-media effect is negligible.

Cooling water is needed to cool the induction coil.

Technical considerations relevant to applicability

The applicability of inductive heating in a single wire line concept is quite wide and includes applications where exact temperature control is required.

Use of inductive heating in a multi-wire line concept is limited to applications where exact temperature control is not an issue, e.g. preheating.

Applicability is dependent on wire properties. See above.

Economics

No information provided.

Driving force for implementation

No information provided.

Example plants

No information provided.

Reference literature

No reference literature provided.

4.4.10 In-line pickling

See Section 5.2.4.1.

4.5 Emerging techniques for wire drawing

No techniques reported.

5 CONTINUOUS HOT DIP COATING

5.1 General information on continuous hot dip coating

The total number of continuous hot dip coating lines in the EU-27 and the United Kingdom in 2019 is 92 with a total nominal production capacity of 3 724 t/h. More specifically, the number of continuous hot dip coating lines depending on their nominal production capacity can be summarised as follows:

- 9 lines with nominal production capacities within the range 0 t/h to 19 t/h, for a combined nominal capacity of 102 t/h;
- 32 lines with nominal production capacities within the range 20 t/h to 39 t/h, for a combined nominal capacity of 955 t/h;
- 44 lines with nominal production capacities within the range 40 t/h to 59 t/h, for a combined nominal capacity of 2 191 t/h;
- 7 lines with nominal production capacities within the range 60 t/h to 79 t/h, for a combined nominal capacity of 476 t/h.

Table 5.1 gives the production of hot dipped metal coated sheets for a number of European countries in 2021.

Table 5.1: Production of hot dipped metal coated sheets in Europe in 2021

	Production of hot dipped metal coated sheets [thousand t]
Austria	2 216.7
Belgium	3 149.9
Bulgaria	0
Czech Republic	0
Denmark	0
Finland	802.0
France	3 852.1
Germany	6 024.9
Greece	0
Hungary	86.5
Italy	4 355.8
Luxembourg	447.9
Netherlands	1 204.3
Poland	839.9
Portugal	238.3
Romania	207.0
Slovakia	534.0
Slovenia	0
Sweden	7.9
Spain	1 883.4
United Kingdom	840.3
Total	26 691.5
<i>Source: [1. EUROFER 2021]</i>	

5.2 Applied processes and techniques in continuous hot dip coating

5.2.1 Continuous hot dip coating process overview

In the hot dip coating process, the steel is continuously passed through molten metal. An alloying reaction between the two metals takes place, leading to a good bond between the coating and the substrate.

Metals suitable for use in hot dip coating are those which have a melting point low enough to avoid any thermal changes in the steel product, for example aluminium, lead and zinc.

The principal hot dip coatings for steel sheet are shown in Table 5.2. Wire is hot dip coated with zinc (galvanised) or tin. Zinc coating is mainly applied as corrosion protection. Tin gives the wire a shiny appearance and also provides a solder adhesive layer.

Table 5.2: Main hot dip coatings for steel sheet

Coating base	Bath	Coating	
		Type	Name
Zinc base	Zn-Al	99.8 % Zn, 0.2 % Al	GI
	Zn-Al	99.88 % Zn, 0.12 % Al	Galvannealed
	Zn-Al	99 % Zn, 1 % Al	Crackfree
	Zn-Al	95 % Zn, 5 % Al	Galfan
	Zn-Al-Mg	91-99.5 % Zn, 0.2-6 % Al, 0.5- % Mg	Zn-Al-Mg coating
	Zn-Mg	99.5-95 % Zn, 0.5-5 % Mg	ZM (various commercial names)
Aluminium base	Al-Zn	55 % Al, 43.5 % Zn, 1.5 % Si	Galvalume
	Al	Al	Type I
	Al-Si	90 % Al, 10 % Si	Alusi

Source: [3, EUROFER 2020], [91, EUROFER 2019], [126, EUROFER, TG Coating 1998], [127, Continuous Coating Shadow Group 1999]

In general, **continuous coating lines for sheet** comprise the following steps:

- surface cleaning by means of chemical and/or thermal treatment;
- heat treatment;
- immersion in a bath of molten metal;
- finishing treatments (e.g. skin pass, chromating, oiling).

Continuous wire galvanising plants involve the following steps:

- pickling;
- fluxing;
- galvanising;
- finishing.

5.2.2 Galvanising of sheet (zinc and zinc alloy coating)

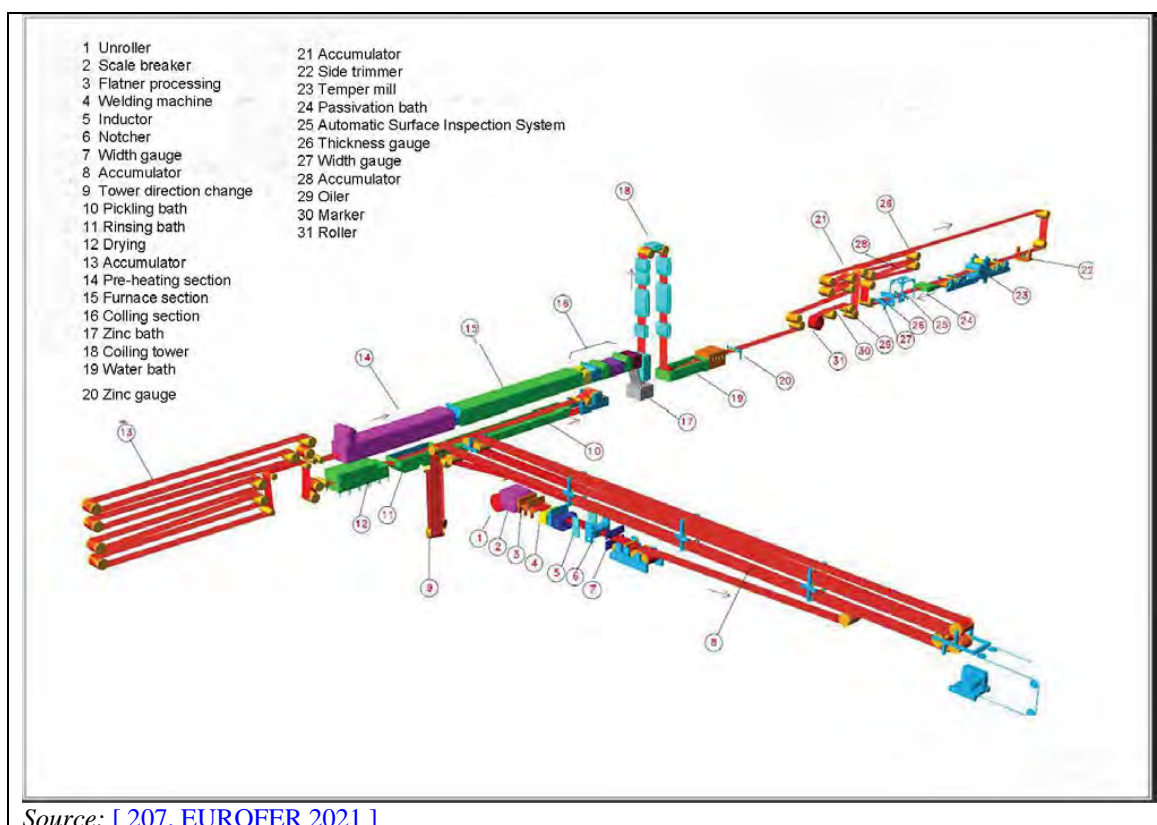
In continuous hot dip galvanising, steel strip is coated with a zinc or zinc alloy layer as corrosion protection. Plant layouts may vary in the design of the entry section (with/without pickling or alkaline degreasing), in the design of the annealing furnaces (vertical or horizontal) or the post-dipping treatment (galvannealing etc.)

Hot dip galvanising of cold rolled strip is more common than galvanising hot rolled strip. In both cases, the galvanising process is similar. However, in the case of hot rolled strip, additional pickling is necessary beforehand and lower temperatures are applied for heat treatment, as there is no need for annealing.

5.2.2.1 Pickling

Pickling for descaling is only necessary for galvanising hot rolled products to remove hot mill scale. This is done using hydrochloric acid, followed by rinsing. The technology is the same as the pickling process described in Chapter 3 of this BREF.

The general structure of a hot dip coating line coupled to a pickling section dedicated to the processing of hot rolled coils is shown in Figure 5.1. [207, EUROFER 2021]



Source: [207, EUROFER 2021]

Figure 5.1: General structure of a hot dip coating line dedicated to the processing of hot rolled coils coupled to a pickling section

5.2.2.2 Degreasing

It is essential that the surface of the steel coil is free of impurities such as grease, oil or abraded iron fines to ensure that the entire surface is exposed to the coating product and strong adherence is achieved. Degreasing may not be necessary with furnaces equipped with a direct flame furnace (DFF) section, but it can be applied in any case. The cleaning process involves several or all of the following steps:

- alkaline degreasing via immersion or by spraying; may be coupled with brushing;
- alkaline degreasing by an electrolytic system; may be coupled with brushing;
- rinsing with water with intermediate brushing between rinsing tanks;
- drying.

Figure 5.2 shows two possible layouts for modern degreasing lines.

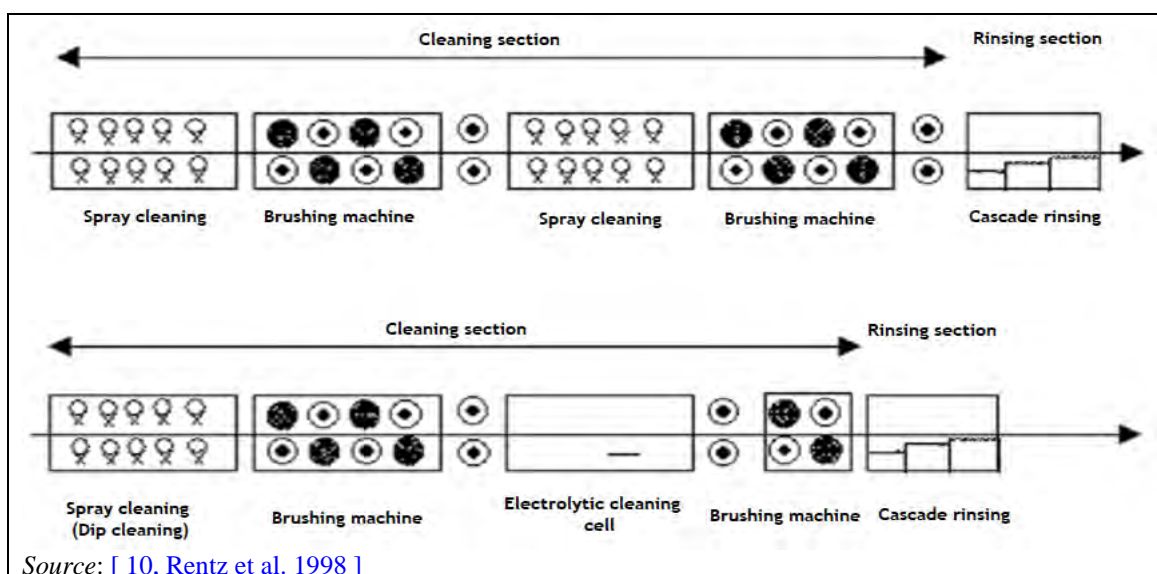


Figure 5.2: Degreasing line layouts

The degreasing agent is always a silicon-free alkaline solution with a concentration of around 25 g/l and a temperature between 70 °C and 95 °C. Aqueous systems are now standard and solvent degreasing is obsolete. [127, Continuous Coating Shadow Group 1999], [128, ERM 1995]

The same aqueous solution containing mainly sodium hydroxides, orthophosphates and surfactant compounds is used in spray degreasing and in electrolytic degreasing. Once the solution in the electrolytic degreasing section has reached a certain oil level, it is reused in the spraying section (cascade use). It is also possible that the solution is treated in an emulsion separation centre and then biologically treated. [127, Continuous Coating Shadow Group 1999] When the solution has reached the maximum oil content it is regenerated, usually off site. [126, EUROFER, TG Coating 1998]

Fumes generated in degreasing and brushing are collected and scrubbed prior to release, using water or caustic soda solution, and/or led through a demister for cleaning. [127, Continuous Coating Shadow Group 1999] Spent degreasing agent and waste water from the rinsing and brushing operations are sent to waste water treatment before release. [126, EUROFER, TG Coating 1998]

5.2.2.3 Heat treatment

Hot and cold rolled steel coil are passed through a furnace with controlled atmosphere prior to galvanisation to degrease and dry the surface, to improve the adhesive properties of the surface, to obtain the required mechanical properties of the steel and to allow the steel to reach the required temperature before dipping. The following types of furnaces are used:

Direct-flame furnace (DFF)

The direct-flame furnace (non-oxidising type) can be divided into different sections:

- a warming-up section where the strip is preheated using the gas flow coming from the furnace; the temperature raises from 20 °C to approximately 250 °C;
- the furnace itself, where the coil is heated directly by means of a naked flame, reaching a temperature between 560 °C and 800 °C;
- the annealing zone where radiant elements (e.g. radiant tubes, electrical resistances) heat the strip up to 850 °C and maintain this temperature under a reducing atmosphere (HN_x atmosphere, 3–20 % hydrogen);
- the soaking/equalising section operated with radiant elements;
- two cooling areas, with different cooling rates, where the temperature of the steel is reduced by jet cooling down to 450–480 °C;
- the exit area where the steel goes towards the galvanising bath.

This type of furnace cleans the coil surface and may not require any prior degreasing of the metal depending on the required surface qualities. Emissions to air are generated as the remaining oil from the surface is burnt. Furthermore, combustion products H₂ and N₂ arise from the furnace (fired by natural gas or desulphurised coke oven gas). [[126, EUROFER, TG Coating 1998](#)], [[127, Continuous Coating Shadow Group 1999](#)], [[129, EUROFER 2019](#)]

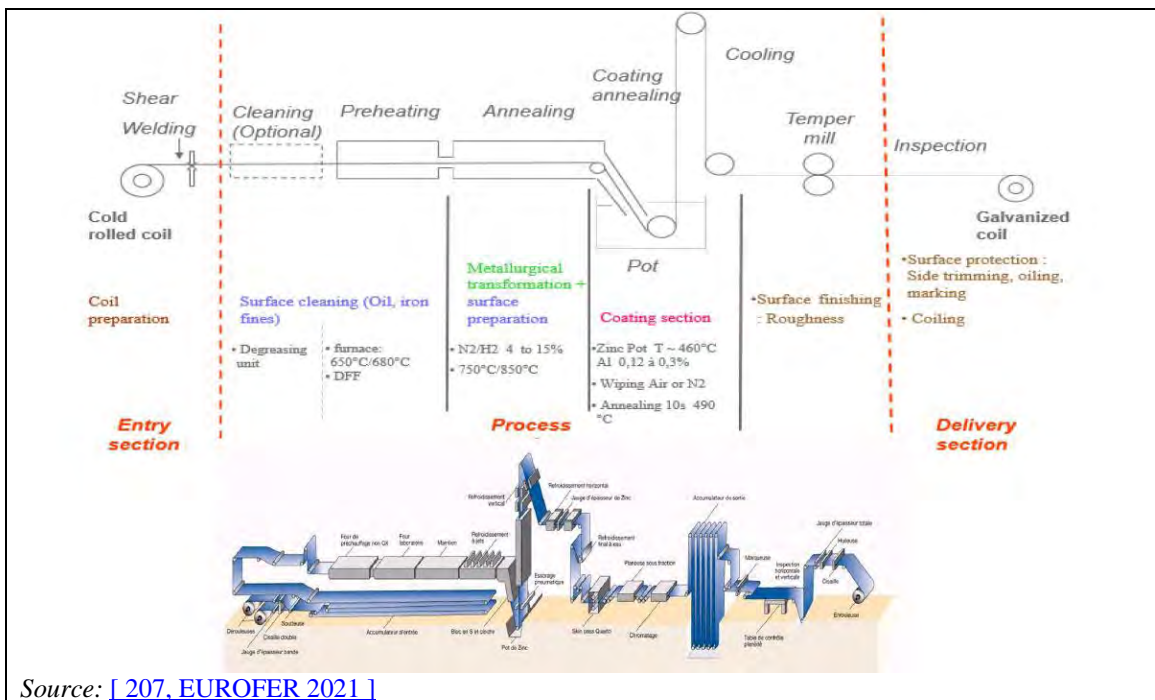
The general structure of a hot dip coating line equipped with a direct flame furnace for processing hot rolled coils and cold rolled coils is provided in Figure 5.3.

Radiant tube furnace (RTF)

The radiant tube furnace is a variation with indirect heating. The combustion gases circulate through radiant tubes and do not come into contact with the strip. The soaking zone can be fitted with radiant tubes or electric heating. Alkaline degreasing combined with radiant tubes or electric heating are required for very high quality standards and for improving the adherence of the metallic coating. The fast-cooling areas are similar to those of a DFF. [[126, EUROFER, TG Coating 1998](#)], [[127, Continuous Coating Shadow Group 1999](#)], [[130, Continuous Coating Shadow Group 2000](#)]

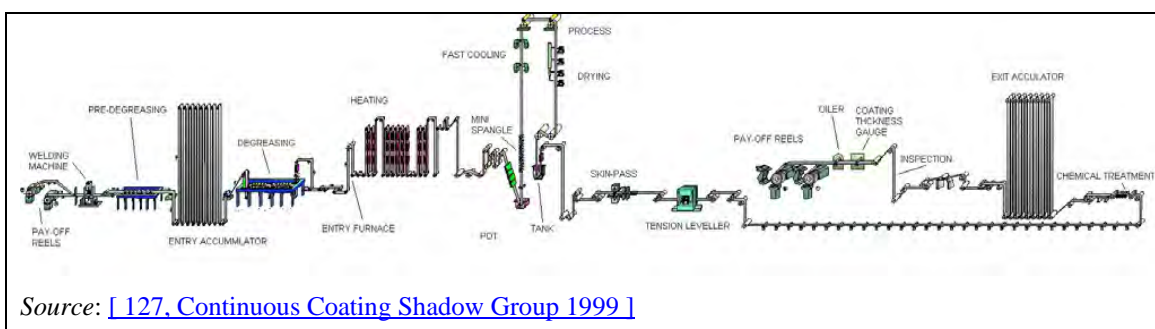
Fuels used are natural gas or desulphurised coke oven gas. Energy conservation is a primary consideration in modern furnace designs. Recuperative features, such as infrared waste gas preheaters, preheating of combustion air in direct-flame furnaces and radiant tube furnace burners, preheating of furnace atmosphere gas and installation of waste heat boilers are generally incorporated when feasible.

The general structure of a hot dip coating line equipped with a degreasing section and a radiant tube furnace for processing cold rolled coils is shown in Figure 5.4.



Source: [207, EUROFER 2021]

Figure 5.3: General structure of a hot dip coating line equipped with a direct flame furnace for processing hot rolled coils and cold rolled coils



Source: [127, Continuous Coating Shadow Group 1999]

Figure 5.4: General structure of a hot dip coating line equipped with a degreasing section and a radiant tube furnace for processing typically cold rolled coils

5.2.2.4 Hot dipping (galvanising)

The galvanising bath consists of one or more tanks, insulated with ceramic (refractory) material. These pots, which can be either fixed or mobile, contain the molten metal at a temperature of 400-490 °C, through which the strip is passed. The bath contains zinc and any other required additive (i.e. aluminium or magnesium). The bath contains a sufficient amount of molten zinc in order to prevent the wide fluctuations in the operating temperature that may appear under maximum operating conditions. Most pots are heated by electrical induction systems. Electrical resistances are also used. [126, EUROFER, TG Coating 1998], [127, Continuous Coating Shadow Group 1999]

As the steel passes through the molten zinc bath, the surface is coated with an alloyed layer whose composition mostly reflects the composition of the molten bath. Coatings can be Zn-based as well Al-based. Other elements can be present such as Mg and Si. Coating thickness ranges from less than 100 g/m² (both sides) to over 800 g/m² (both sides). [3, EUROFER 2020]

Modern zinc baths are equipped with a three-roll system, whereby two of them are stationary and one roll is movable as shown in Figure 5.5.

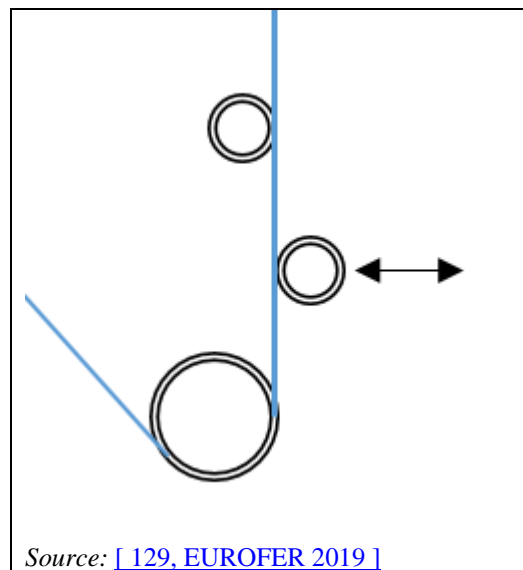


Figure 5.5: Detail of a three-roll system used in continuous hot dipping baths

Aluminium is generally added in small amounts (0.15-0.19 %) in order to make the alloy layer less brittle and thus improve the ability of the end user to form the product, while maintaining good adhesion of the coating during the forming operations. [131, ILZRO 2003]. Higher aluminium concentrations may result in spot weldability problems. [132, Dallin 2015]

Temperature control and the aluminium content of the bath are essential and optimised to meet the individual quality requirements of the final coated product. [3, EUROFER 2020]

The strip leaves the bath with some amount of liquid zinc on the surface. In order to achieve the exact thickness of coating required, the strip passes through a series of jets (air knives) placed above the surface of the bath. By blowing air or nitrogen, the excess zinc is removed from the steel. The system is usually controlled by an automatic gauge, which measures the thickness of the coating using X-ray measurement technology or a similar technique.

On leaving the bath, the strip is gradually cooled by air coolers, followed by a water quench tank and a dryer.

5.2.2.5 Galvannealing

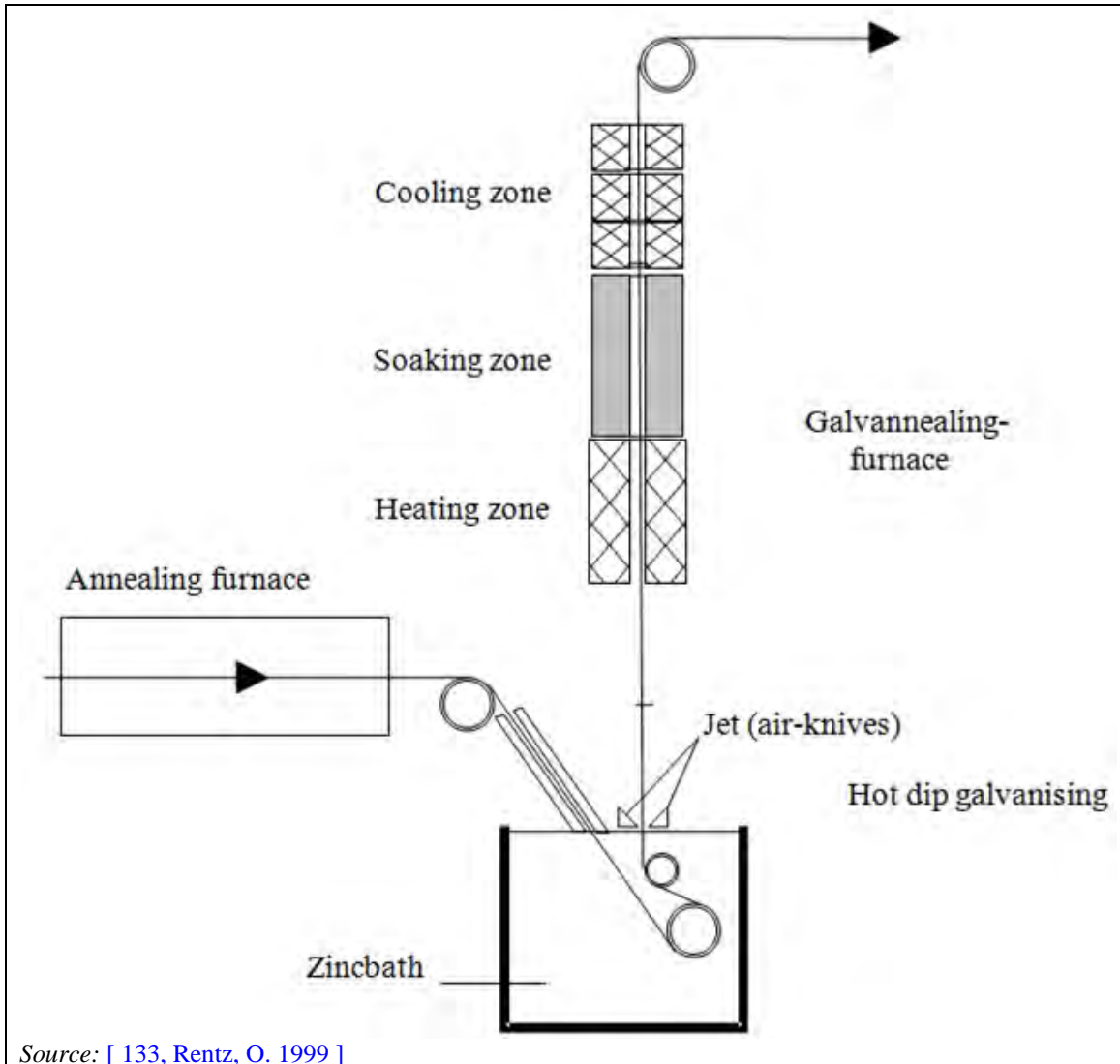
Galvannealing is a special post-treatment applied in some installations in which the strip, after galvanising, is heated to a temperature that allows the formation of a zinc-iron alloy (10 % iron). Galvannealing results in the product having a particularly smooth appearance.

Galvannealing is the alloying of the zinc layer by the diffusion of iron (Fe) from the steel substrate. The iron diffusion is obtained by maintaining the steel at a temperature of about 500 °C, for low-carbon steel, to a temperature of about 540 °C, for new-generation high strength steel, during a sufficient time. Such furnaces are divided in two zones: a heating zone and a soaking zone. The available space for the furnace is limited. For the same available surface, a very quick heating from the zinc bath temperature (460 °C) to the soaking temperature allows a longer soaking time to be applied. Some furnaces are equipped with an induction heating system in the heating zone and electrical elements or radiant tubes in the soaking zone. The induction heating technique is characterised by a short heating time, a short reaction time, and an accurate

regulation of the temperature and no emissions on the site. The alloying and surface qualities are improved.

Other galvannealing furnaces are equipped in the heating zone and in the soaking zone with radiant tubes characterised by a longer heating time. In that case, the site emissions and the energy consumption are improved by the use of low-NO_x burners and regenerative or recuperative burner systems. [130, Continuous Coating Shadow Group 2000]

Figure 5.6 shows the schematic of view of the coating section and the galvannealing furnace.



Source: [133, Rentz, O. 1999]

Figure 5.6: Schematic coating section of a galvannealing line

5.2.2.6 Finishing

To give the steel a special surface appearance, smoothness, flatness, etc. as required by the customers or to meet width tolerances, the following operations may be applied:

Skin pass / Temper rolling

Whether it is galvanising or galvannealing, many end uses require a surface that is more topographically uniform than obtainable directly off hot dip coating lines. The method most often used to make the surface more uniform is known as 'skin passing', 'temper passing' or 'temper rolling' and is done with a skin mill or a temper mill. The strip is skin-passed to obtain a textured surface, by means of a rolling machine. In-line temper rolling is an important part of producing exposed quality coated sheets. It eliminates an off-line operation that would increase

costs and imparts a carefully controlled surface finish, mechanical property control, and good flatness.

The four-high design is common and incorporates tension bridge rolls before and after the temper mill to allow extensions up to 2 % to achieve the required surface finish and mechanical properties. Work roll bending is incorporated for optimum shape control.

With coated steel sheet, temper rolling is generally performed with work rolls having a blasted surface finish (texture). The roll finish is partially imparted to the sheet surface and has the effect of reducing the metallic sheen of bright hot dip coatings to a uniform dull appearance. Skin pass treatment can be performed in different ways: dry or wet (only water or with water and detergent). A wet rolling practice prevents surface contamination and zinc pick-up. The 'temper mill' solution generated in the latter process must be collected and sent to a waste water treatment plant when it is spent.

On most lines, load rather than extension usually controls the temper mill. The small amount of cold work imparted to the steel by temper rolling to smooth the surface finish has the added benefit of eliminating the yield point phenomenon exhibited by low-carbon steel (if not temper rolled, levelling of the sheet also accomplishes this). Usually, a typical modern configuration consists of three bridges, with a skin pass installed between the first and the middle bridge and a tension leveller between the middle and the third bridge. [129, EUROFER 2019], [132, Dallin 2015]

Tension levelling

A tension leveller, located immediately after the temper mill, provides superior flatness while maintaining precise control of elongation. The presence of intermediate bridge rolls between the temper mill and leveller permits control of elongation, independent of the temper mill mode. Extensions of up to 1.5 % are attainable with the leveller. The tension leveller eliminates unevenness such as waviness, bows or longitudinal and latitudinal curves. This ensures an even final product. [129, EUROFER 2019], [132, Dallin 2015]

Edge cutting

For certain applications, edge cutting must be done in order to obtain the width tolerance needed and to avoid little dog bone defects. There are two places to realise this process:

- in the pickling line before cold rolling;
- in the hot dip coating process (sidetrimmer at line exit).

A perfect product schedule tries to reduce this process to the minimum to increase the line yield. [127, Continuous Coating Shadow Group 1999]

5.2.2.7 Post-treatments

Following the coating, the steel strips are usually subjected to post-treatment in order to prevent surface damages and flaws, like white rust caused by water condensation in the case of insufficient air access. Voluminous corrosion products such as zinc hydroxides (white rust) affect further processing, e.g. painting. The formation of condensate during transportation and storage is to be generally prevented. Resistance against white rust is considerably increased by the application of a post-treatment, like oiling, passivation, phosphating, organic coating or a combination of such treatments. [127, Continuous Coating Shadow Group 1999]

Anti-fingerprint: wringer rolls treatment of a polymer base coating on the strip surface. A coat weight (after drying) of < 1.5 g/m² per side is applied.

Oiling

To apply a wet film of oil on the surface of the strip electrostatic oiling machines are usually used or, less frequently, dip spray or wingrolls. The oiling coat is between 0.25 g/m²/side and 3 g/m²/side. [127, Continuous Coating Shadow Group 1999]

Passivation

Chemically passivated steel strips from the steelmaking industry are produced inline in a galvanising line. This means that the passivation solution is applied through a spray header onto the top and bottom sides (superfluous wet film is squeezed off by means of hard rubber rollers) or supplied with a chemcoater on the bare galvanised strip. The wet film is subsequently dried (e.g. hot air dryer, infrared dryer).

Passivation techniques

There are many possibilities, which depend on the chemical passivation ingredients (non-exhaustive list as follows):

- I. Cr (VI) passivation (although this is not considered as BAT due to environmental issues);
- II. Cr-free passivation one; e.g. consisting of types of manganese, zinc, titanium fluoride, phosphates and molybdates;
- III. Cr-free passivation two; with an organic system, e.g. consisting of acrylic and carboxylatic polymers and phosphates;
- IV. Cr (III) - passivation; e.g. consisting of types of Cr (III) fluorides.

The use of chromium (VI) compounds is subject to authorisation under REACH because these compounds are included on the authorisation list of the REACH Regulation (1907/2006) (Annex XIV). The sunset date for the use of chromium (VI) compounds on this list was 21/09/2017. An authorisation is necessary for operators to continue using Cr (VI) compounds after this date; otherwise, it is not possible to use this passivation technique anymore.

More information on Cr-free and Cr (III) passivation techniques may be found in Section 5.4.1.5.6.

Phosphating

In phosphating, a phosphate coat of approximately 1–1.8 g/m² is applied. The phosphating procedure is more or less a precipitation reaction of zinc phosphate crystals at the surface of the metal coat caused by an increase in the pH value at the metal surface due to a pickling reaction. The tri-cation phosphation process could be used (the hopeite crystal $Zn_3(PO_4)_2 \cdot 4 H_2O$ incorporates approximately 1 % nickel and 5 % manganese). Thus, this process forms the same chemical structure of the phosphate coat as the high-quality phosphating processes for cars and household appliances do. [\[127, Continuous Coating Shadow Group 1999 \]](#)

5.2.2.8 Cooling water circuits

In coating plants, cooling water is required to discharge excessive heat from furnaces. Part of the heat energy is emitted directly to the air (with the waste gases), via the coated strip or the shop air. The rest is transferred to the cooling water. The main cooling water consumers are the furnace (roll bearings) and final cooling of the strip.

A coating plant is supplied with cooling water recirculated from central cooling water systems. In these systems, pumps convey the cooling water to the consumers; the heated water is returned and recooled again in plate heat exchangers with industrial water (e.g. from the river).

Due to the insertion of the closed recooling water circuits, the industrial water, even in the event of the leakage of a cooler, does not come into contact with the equipment of the consumers; so the entry of chemicals or oil into the industrial water and pollution of the sewage system are prevented.

There are several variants of recooling; two of them are:

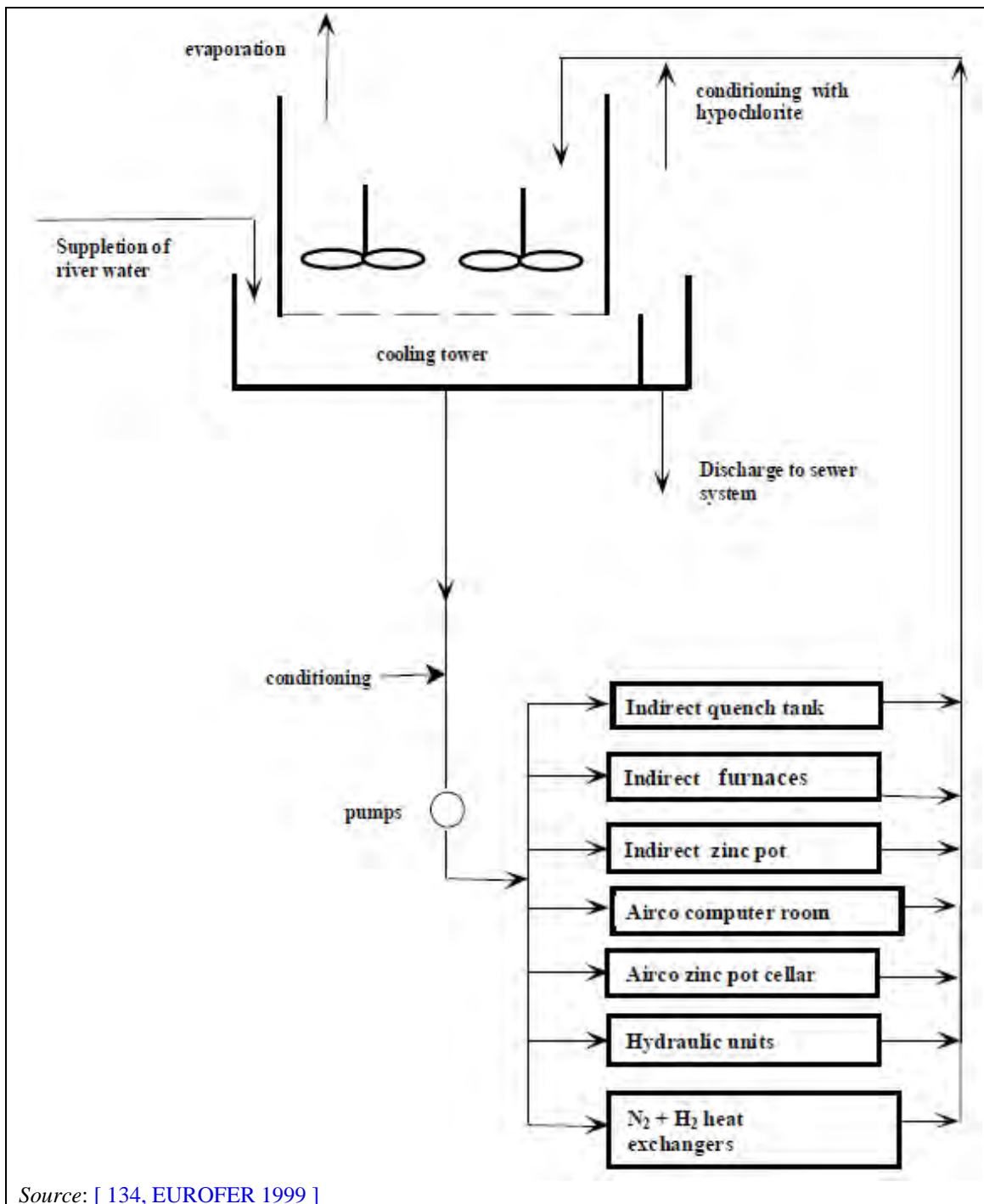
- recooling with industrial water in heat exchangers;
- recooling by evaporation in cooling towers.

Compared to recooling in towers, recooling in plate exchangers offers the advantage that considerable amounts of chemicals for cooling water treatment (such as corrosion inhibitors, hardness stabilisers, dispersants and biocides) can be saved, and are not discharged into the sewage system. Another advantageous feature is that it is not necessary to discharge partial flows with a high salt content caused by the evaporation, as was the case of cooling towers. [[126, EUROFER, TG Coating 1998](#)]

Typical configuration of a cooling loop with cooling towers

The little discharge that is necessary for keeping a low salt concentration in the water sent to the sewer system is mostly carried out continuously. Algaecide (for avoiding the saturation of the contact zone between the water and the air) is dosed. The frequency is variable depending on the weather (between one and three times a week).

Other chemicals could be necessary depending on the composition of the water used in the circuit (hardness, etc.).



Source: [134, EUROFER 1999]

Figure 5.7: Typical configuration of a cooling loop with cooling towers

Configuration for recycling water using a plate heat exchanger

Cooling water is recirculated in several closed cooling systems and heated by the heat expelled from the process (machine cooling, gas cooling, etc.). The cooling water is recooled by river water in heat exchangers. The river water on the secondary side of the heat exchanger is never in contact with the strip or harmful media and is therefore not contaminated. The water becomes only heat-loaded and can be drained back to the river. The main cooling water consumers are the preheating and annealing furnaces, the zinc pots, several roll coolings, the immersed water coolers, the activation section, the electrical equipment, the hydraulics and air conditioning.

All heat which is not removed by the cooling water has to be discharged either as waste gas or to the ambient air.

With this system, the addition of algacide and scale-preventer is avoided. The outlet water is only heat-loaded. This is advantageous if the system water does not come into contact with any contaminants.

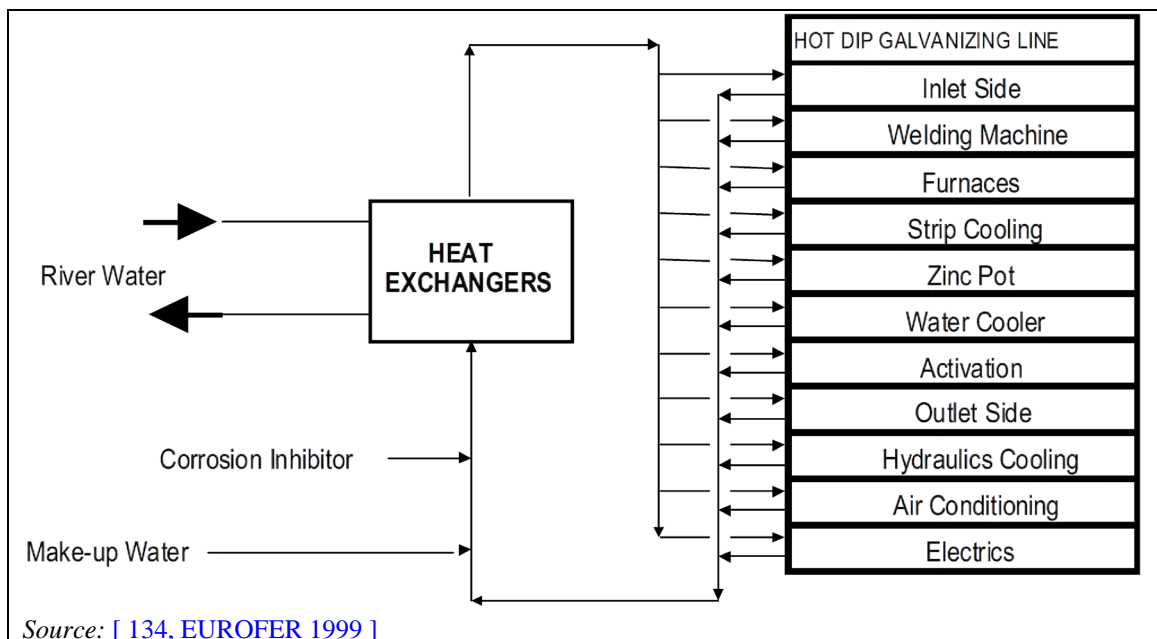


Figure 5.8: Cooling water system with heat exchangers

5.2.2.9 Water circuits / Water management

Process water is water which is used for make-up of chemical solutions or which is in direct contact with the strip (e.g. water for direct strip cooling). It may be contaminated by the process and has then to be treated as waste water. The following process water streams are used at galvanising lines and are finally discharged as waste water:

- Make-up water (usually deionised water) for concentrate preparation of the chemical strip treatment sections (pretreatment, electrolytic treatment, post-treatment). The different concentrates are sprayed onto the strip or the strip is run through the concentrate bath or the different concentrates are applied with chemcoaters. [3, EUROFER 2020] The concentrates are usually recirculated by pumps. They are clarified or filtered in recycling plants during recirculation. Only a small flow is discharged to the water treatment plant.
- Waste water from rinsing and brushing operations in degreasing where the strip, even if not yet coated, comes in contact with process water in the degreasing section.
- Rinsing water (usually deionised water) for chemical treatment sections (pretreatment, electrolytic treatment, post-treatment). The rinsing water is used for removal of the remaining concentrate from the strip. The water is sprayed onto the strip in a cascade of rinsing sections, with the water flowing countercurrently to the strip. It is finally discharged as low concentrated waste water to the water treatment plant.
- Make-up water for the water cooler. In the water cooler, the strip is cooled first by recirculated spray water and finally by being run through a water bath with an immersed turn back roll. The water will be contaminated by abrasion dust and has to be discharged from time to time to the skin-pass mill water treatment plant.
- Spray water for the skin-pass mill. The water is used for keeping the working rolls clean. It is sprayed onto the rolls and contaminated by Zn-containing abrasion dust and lubricating oil and is discharged to the skin-pass mill water treatment plant.

5.2.3 Aluminising of sheet

Most aluminium-coated steel coil is produced by some variation on the hot dip galvanising process. Figure 5.9 shows the schematic line of production for applying aluminium coatings. The production line usually includes a passivation section, which is either in-line or is off line in a separate process unit.

Due to the affinity of aluminium for oxygen, it is extremely important to ensure against the formation of an oxide layer which would prevent diffusion of the aluminium into the steel substrate. The formation of an oxide layer can then be prevented by using a number of methods, e.g. by passing the washed and pickled steel through a furnace with a hydrogen atmosphere to eliminate oxygen (the absorbed hydrogen further protects the substrate as it passes into the molten aluminium bath).

The aluminium bath is generally maintained at temperatures of about 690 °C. The coated coil can then be further heat-treated at 820–930 °C, which converts the aluminium coating completely to steel-aluminium alloy if required. [128, ERM 1995]

Following the coating, the strips may be subjected to post-treatment in order to prevent surface damage and flaws, such as white rust caused by condensation in the case of insufficient air access.

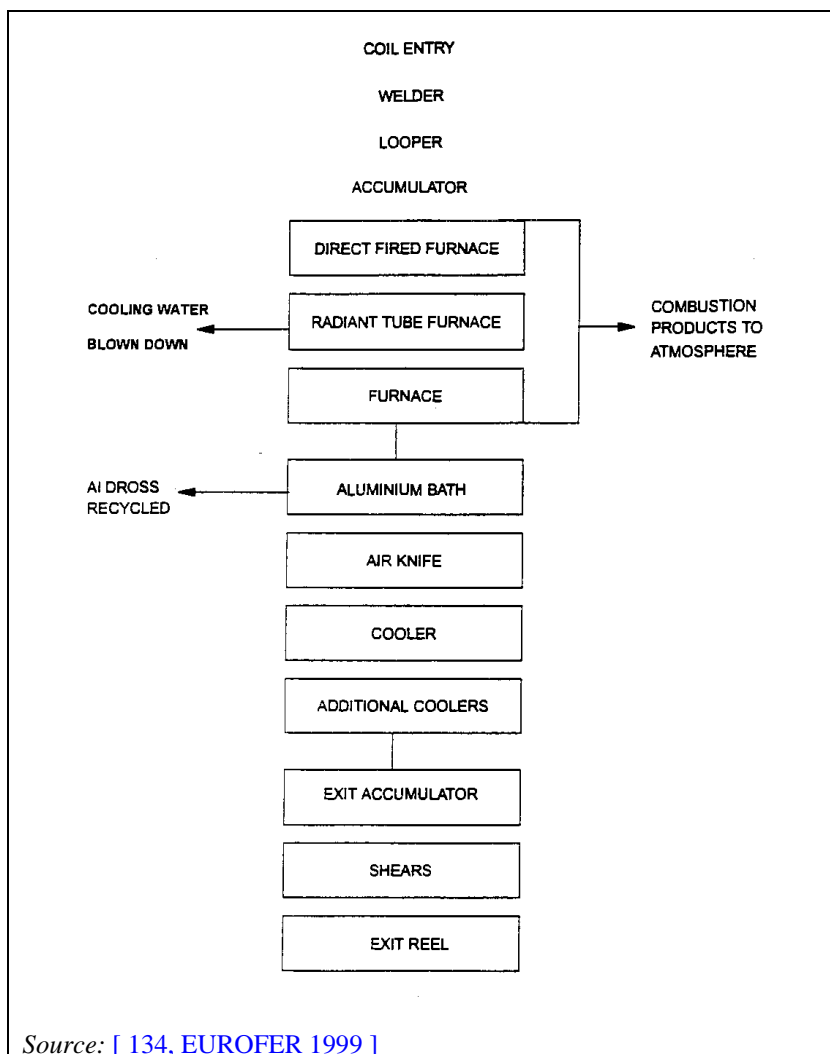


Figure 5.9: Aluminium coating process

5.2.4 Wire hot dip coating

Wire is hot dip coated mainly with zinc and zinc alloys (e.g. Galvan (95 % Zn, 5 % Al)); the main function of these types of coating is corrosion protection. Other coatings that are applied by hot dipping are tin and aluminium. Aluminium is used for some corrosion protection on niche products. Tin gives a shiny appearance and also provides a solder adhesive layer. The application processes for these hot dip coatings are basically the same.

A continuous hot dip coating line for wire consists of the following process steps: the wire is pickled, rinsed, dipped in a flux bath, dried, passed through the molten metal bath and cooled again. Finally, a water-based protective coating (so-called wax) can be applied after the hot dip coating step. [\[121, Gielen 1999 \]](#)

5.2.4.1 Continuous pickling of wire

After in-line pickling or as a starting step for hot dip coating, the wire is pickled to remove surface debris to improve its appearance or to prepare the surface for the application of coatings. This is usually done in-line either by immersing the wire in an acid bath or by subjecting it to a neutral salt bipolar electrolysis cell.

In acid pickling, the wire is cleaned by passing it continuously through one or more hydrochloric acid baths; sometimes H_2SO_4 is used. Due to the short residence times, the HCl acid is often heated (up to 60 °C) or is used in concentrated form. The type of impurities that are removed in this bath depend on the previous process step:

- For heat-treated wire: metal oxides, residues of soap carrier, possibly traces of lead.
For drawn wire: residues of soap, oil or other lubricants and traces of rust. Sometimes a degreasing agent is added to the HCl bath to enhance removal of these substances. [\[121, Gielen 1999 \]](#).

Faster pickling and higher wire speeds are realised by increasing the length of the bath, by increasing the temperature of the HCl, by increasing the concentration of the bath or by applying electrolytic assisted pickling. HCl fumes from the pickling baths are collected and removed by scrubbing.

After pickling, the wire is passed through a rinsing cascade. [\[121, Gielen 1999 \]](#)

5.2.4.2 Fluxing

For good adhesion of the zinc coating, the wire is passed through a flux bath, a heated watery solution of $ZnCl_2$ and NH_4Cl (pure $ZnCl_2$ is used for tin coating). Excess flux is removed from the wire by wiping. Prior to coating, the wire is dried; this can be done in a furnace or with the internal heat of the wire. With high wire diameters and/or efficient wipers, the internal heat of the wire (due to the heating in the flux bath) is sufficient to secure a dry wire. The wire must be dry before entering the flux bath to prevent squirting at the inlet of the zinc bath.

The same flux media are used as for batch galvanising; however, the concentration is generally much lower. For zinc coatings, usually a $ZnCl_2/NH_4Cl$ mixture is used (pure $ZnCl_2$ is used for tin coating). [\[121, Gielen 1999 \]](#)

5.2.4.3 Hot dipping (galvanising of wire)

The wire is passed through a molten zinc bath (430–470 °C). In the zinc bath, an iron-zinc diffusion layer is formed, consisting of sublayers of several Fe-Zn alloys. A zinc layer is formed on top of this at the moment the wire leaves the zinc bath. Galvanising can be divided into heavy (vertical) galvanising (high coating thickness; coating mainly consists of the withdrawn zinc) and regular (horizontal) galvanising (low coating thickness; the coating is mainly an iron-zinc alloy layer). [[119, Gielen 2000](#)]

Most zinc baths are heated through the bottom and the side walls with natural gas or other fuel. Exceptionally, electric heating is used and/or heating is done from above the zinc bath.

A protective layer of particulate material or a bath cover can be applied on (a part of) the zinc bath, in order to minimise formation of zinc oxides and energy losses.

After the zinc bath, the wire is cooled to near ambient temperature using air and cooling water.

Hot dipping in other metals or alloys is done in the same way. [[121, Gielen 1999](#)]

5.2.4.4 Finishing of wire

Finally, a wax layer is applied for protection against formation of so-called white rust (superficial corrosion of the zinc layer).

5.3 Current consumption and emission levels for continuous hot dip coating

5.3.1 Continuous coating mass stream overview

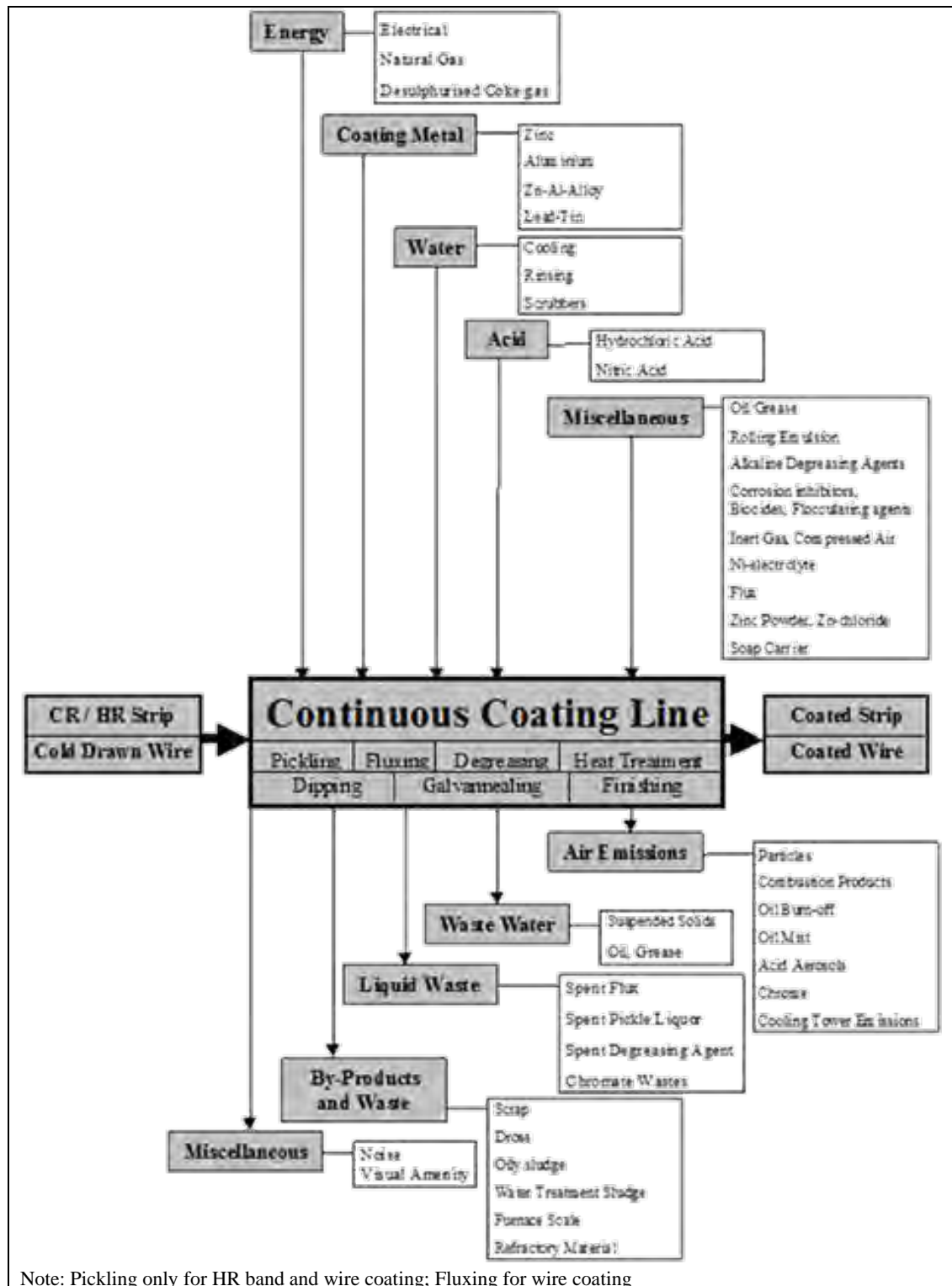


Figure 5.10: Input/output balance for continuous hot dip (sheet) coating lines

The following sections present the consumption and emission data reported by the HDC plants across the EU that took part in the 2018 FMP data collection (in total 30 plants). [16, FMP TWG 2018]. The plants from the data collection are listed in Section 11.1.

Handling of Confidential Business Information (CBI)

Energy, material and water consumption data were considered confidential business information (CBI) by the plant operators. In order to maintain data confidentiality, plant names are not directly mentioned in the graphs but are replaced by anonymised and randomly attributed CBI codes. In addition, no contextual information (e.g. process parameters or techniques applied) is included as this could reveal the identity of the plants. All the consumption figures are presented in ascending order of the maximum specific energy consumption values.

5.3.2 Energy consumption

During the data collection, information was reported about the specific energy consumption (i.e. MJ of energy consumed per total amount of feedstock processed expressed in t/year). This section focuses in particular on specific energy consumption for feedstock heating before hot dipping. For feedstock heating before hot dipping, specific energy consumption data were reported for 25 lines in total, energy consumption ranged from 731 MJ/t to 2 180 MJ/t. Figure 5.11 shows the data reported, per line (23 lines relate to hot dip coating of sheets and 2 lines are associated with hot dip coating of wires), on the yearly specific energy consumption for feedstock heating before hot dipping.

In the case of producing Advanced High-Strength Steels (AHSS) or Ultra High-Strength Steels (UHSS) in a continuous hot dip coating line, it is necessary to heat up the strip to temperatures higher than 850°C and sometimes up to 900°C in comparison with the usual range of 720°-850°C for standard steel grades. This concerns a wide range of steel grades such as Complex Phase, Dual Phase, TRIP (Transformation-induced plasticity), TWIP (Twinning-induced plasticity), or QP (Quenching and Partitioning-type steels). In the specific case of QP products, the strip is heated up up to 900°C. As a second step, the material is cooled down to around 230°C (quenching). Afterwards, the material is heated up a second time, up to about 460°C, followed by an averaging step, before final cooling. This partitioning process enables the diffusion of carbon in the product. Accordingly, the production of a significant share of such steel grades in the future in the product mix of a plant may lead to specific energy consumption higher than 1 100 MJ/t. [95, AT 2020], [207, EUROFER 2021]

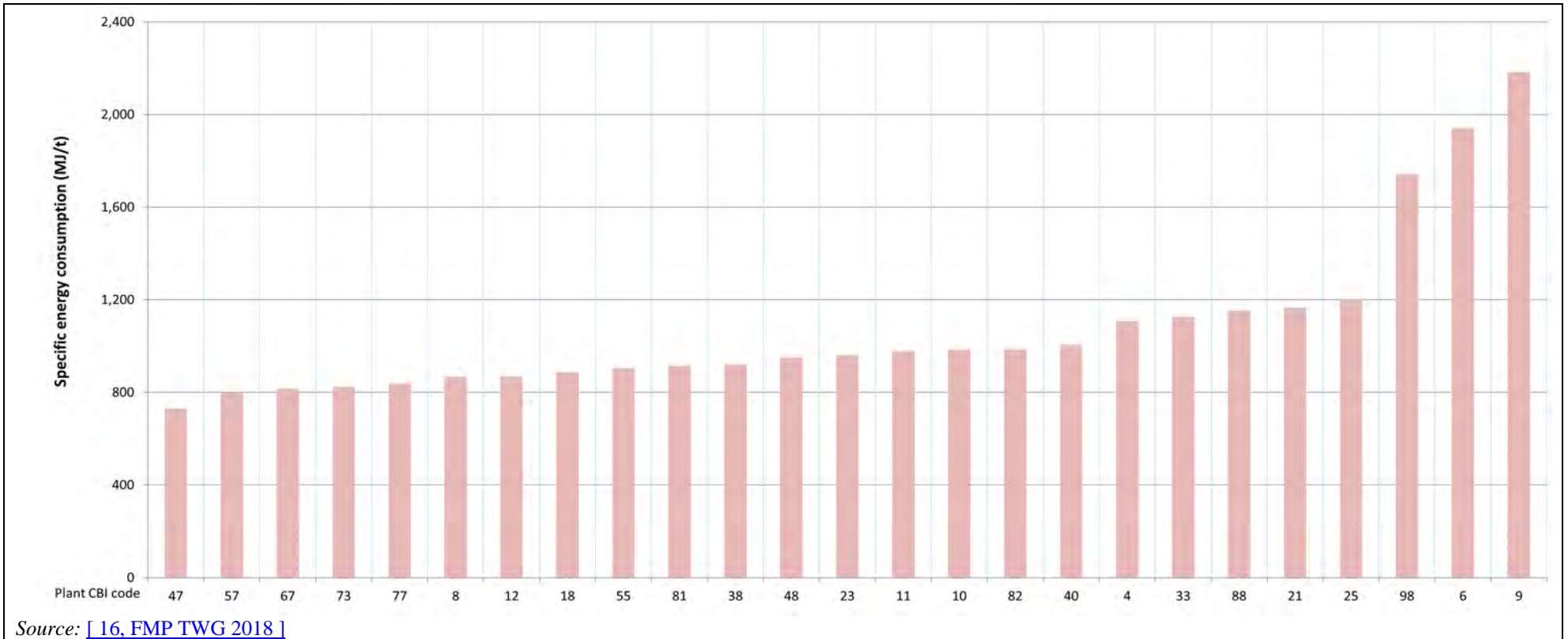


Figure 5.11: Specific energy consumption (MJ/t of feedstock processed) for feedstock heating before hot dipping of sheets and wire

5.3.3 Material consumption

5.3.3.1 Consumption of oils

Figure 5.12 shows the data reported on the specific oil consumption for three operating years, and the yearly average obtained, in hot dip coating plants. Oil consumption values typically ranged from 0.0015 kg/t to 0.43 kg/, except for two plants which reported very high consumption values over 100 kg/t. The data on oil consumption include all types of oils used in the plant (e.g. hydraulic systems oil, anticorrosive oil, emulsion oil).

5.3.3.2 Consumption of acids

In total, 2 plants reported data on the specific HCl consumption for three operating years in hot dip coating plants. The values reported were below 0.05 kg of 33-wt% acid per m² of treated (pickled) surface.

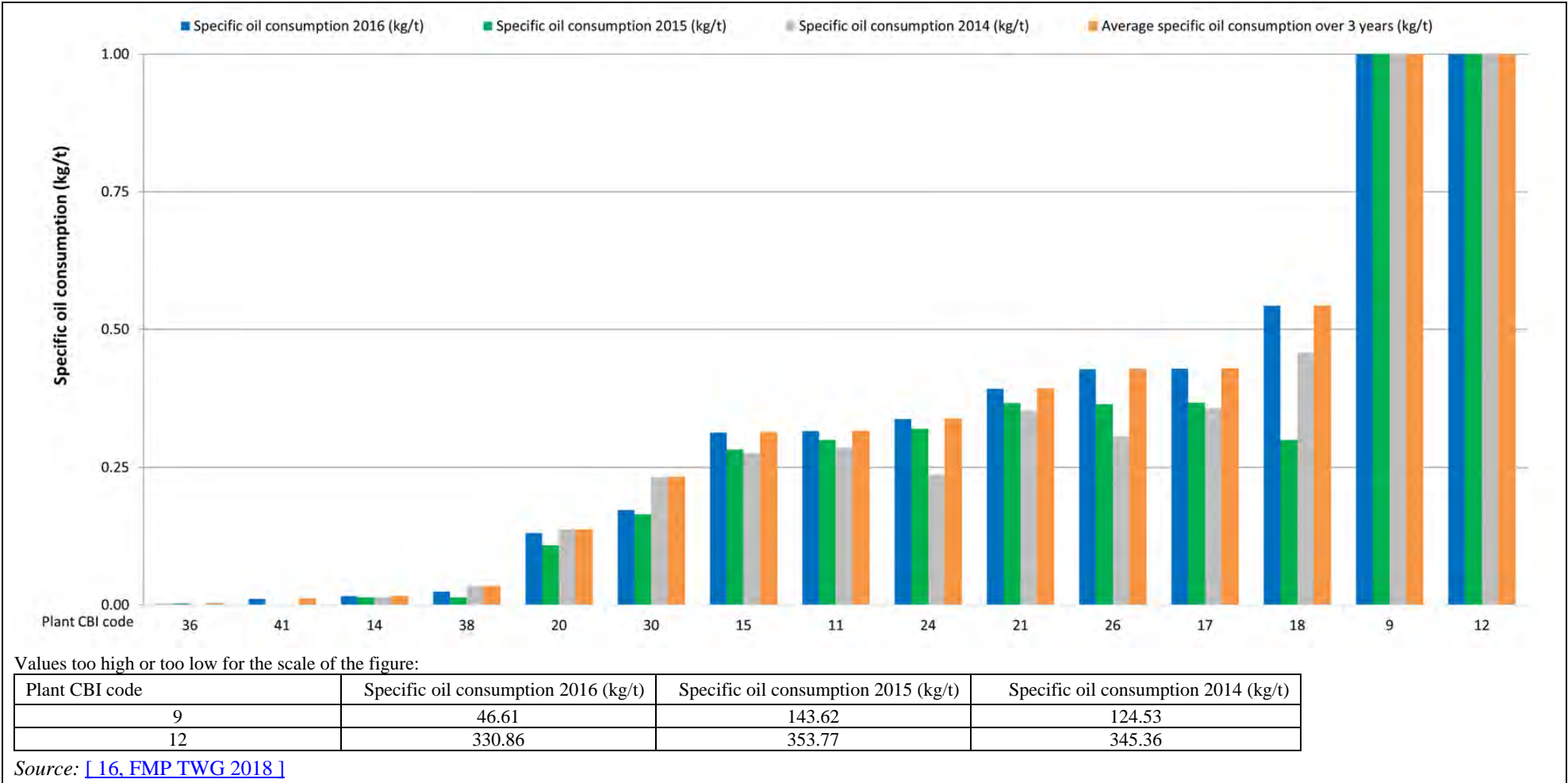


Figure 5.12: Specific oil consumption (kg/t of production) in hot dip coating plants of sheet and wire

5.3.4 Water consumption

Figure 5.13 shows the data reported on the specific water consumption for three operating years in hot dip coating plants. A definition of the specific water consumption can be found in Section 9.4.4.2. The specific water consumption ranged from 0.08 m³/t to 13.9 m³/t, based on data from 17 plants. More specifically, according to the data collection, among the 4 HDC plants that reported to be part of a much larger installation (i.e. integrated iron and steel works), a majority of the plants reported a specific consumption below 5 m³/t, except one plant which reported a very high consumption of 13 m³/t for the year 2016. This value is considered to be an outlier. Indeed, this plant reported specific water consumption below 5 m³/t in 2015 and 2014.

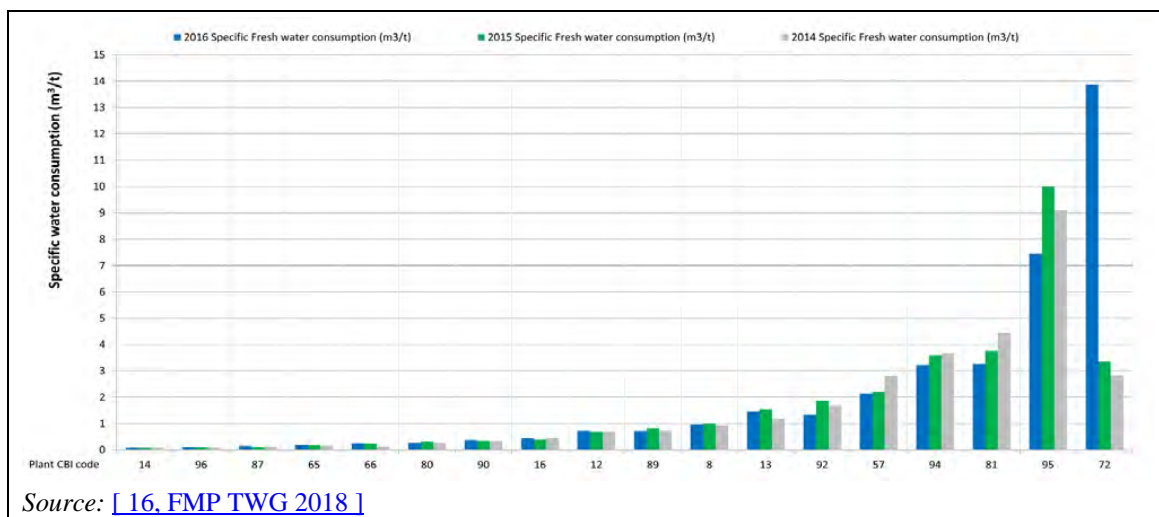


Figure 5.13: Specific fresh water consumption (m³/t of production) in hot dip coating plants of sheet and wire

5.3.5 Emissions to air

5.3.5.1 Emissions to air from heating

In hot dip coating plants, two types of furnace may generate emissions to air including direct flame furnaces (DFF) and radiant type furnaces (RTF). In addition, emissions from galvannealing and hot dipping may also arise if not electrically operated. The different source of emissions are summarised below.

Heat Treatment

- **Non-oxidising type furnaces (DFF):** Natural gas or coke oven gas, previously desulphurised in some cases, are used for firing. The naked flame in this type of furnace is directly heating the strip surface. The pollutants released are: CO₂, CO and NO_x. As the furnace is operated under reducing conditions using inert gases, the waste gas also contains H₂ and N₂. When using coke oven gas as fuel, SO₂ emissions arise, with variable concentrations depending on the sulphur content of the coke oven gas. In some cases, degreasing of the strip prior to heating may be omitted (depending on the required surface qualities). In these cases, the oil is burnt in the furnace and additional air emissions, apart from the fuel combustion products, are generated by the combustion of the oil. [129, EUROFER 2019]
- **Radiant type furnaces (RTF):** The radiant tube furnace is a variation with indirect heating using gas combustion or electric heating. The emissions to air mainly consist of CO₂/CO and NO_x from natural gas combustion. When using coke oven gas as fuel, SO₂ emissions also arise, with variable concentrations, depending on the sulphur content of the coke oven gas. [129, EUROFER 2019]

Galvannealing

In modern facilities, the strip is reheated in an induction furnace. When using conventional gas-fired furnaces, waste gases are generated. The emissions arising depend on the type of gas used. [[129, EUROFER 2019](#)]

Hot dipping (galvanising)

In modern facilities, the molten bath is heated by electric induction systems (in some cases electrical resistances). Older facilities using fuel-oil or gas produce the typical emissions (fumes corresponding to each different type of fuel), namely CO₂, CO, NO_x. When using fuel oil or coke oven gas, SO₂ emissions arise, depending on the sulphur content of the fuel. [[129, EUROFER 2019](#)]

A summary of the emissions of dust, SO₂, NO_x and CO from hot dip coating plants in the FMP data collection is given below.

Dust emissions

The reported data on dust emissions to air from feedstock heating of sheet (heat treatment before dipping and galvannealing) are shown in Figure 5.15. In total, 24 emission points reported the use of 100 % natural gas as fuel with dust emission concentrations ranging from 1.1 mg/Nm³ to 23.2 mg/Nm³ and dust emission loads ranging from 0.008 kg/h to 0.2 kg/h.

Only two plants in the data collection reported the use of iron and steel process gases instead of natural gas, namely plants 129 HDC1 (using 100 % BOF) and 37 HDC1 (using 100 % COG). For plant 129 HDC1, the reported dust emission concentration value was 1.5 mg/Nm³ whereas for plant 37 HDC1, the reported dust emission concentration was 27 mg/Nm³.

SO₂ emissions

The data reported on SO₂ emissions to air from feedstock heating of sheet (heat treatment before dipping and galvannealing) are shown in Figure 5.16. In total, for the plants using 100% natural gas (8 plants and 13 emission points in total), the SO₂ emission concentrations were typically within the range 2.1 mg/Nm³ to 39.3 mg/Nm³ and the emission loads ranged from 0.007 kg/h to 0.5 kg/h. In total, only two plants (4 emission points in total) reported the use of 100 % COG in the data collection, namely plants 179 HDC1 and 37 HDC lines 1, 2 and 3. For these plants, the reported SO₂ emission concentrations were within the range 0.1 mg/Nm³ to 250 mg/Nm³, with a sulphur content of the COG ranging from 15 to 340 mg/Nm³.

NO_x emissions

The effects of the air preheating temperature and burner power have been studied in a radiant tube pilot plant furnace operated by ArcelorMittal in Asturias (Spain). The relationship between the temperature of the preheated air, the burner power and the emissions of NO_x are shown in Figure 5.14. [[3, EUROFER 2020](#)]

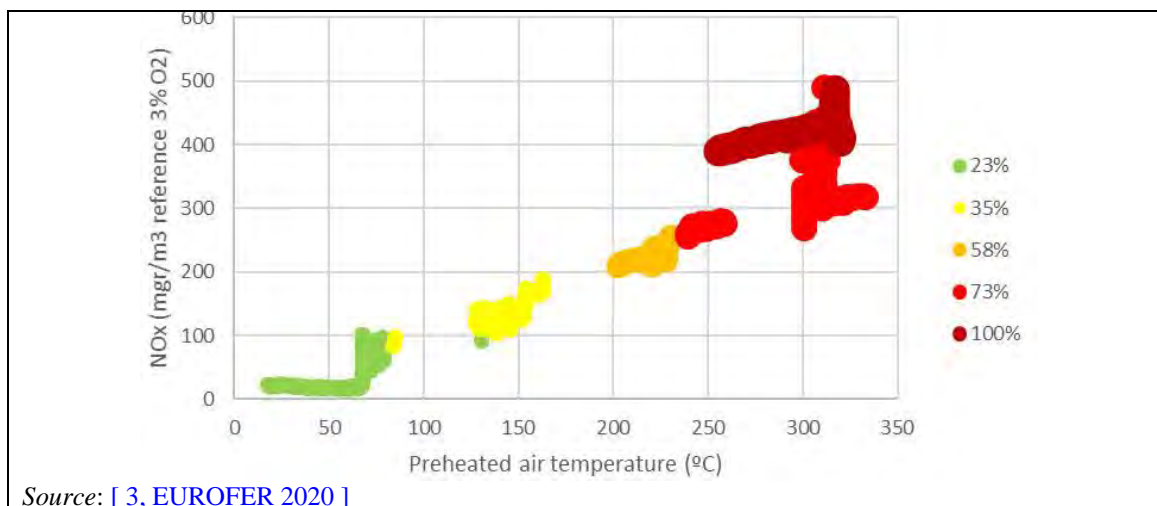


Figure 5.14: Correlation between air preheating temperature, burner power and NO_x emissions measured at a radiant tube pilot plant operated by ArcelorMittal (Asturias, Spain)

From the FMP data collection, the reported data on NO_x emissions to air from feedstock heating of sheet and wire hot dip coating plants (heat treatment before dipping and galvannealing) are shown in Figure 5.17. In total, 20 HDC plants (51 emission points in total) reported using 100% natural gas with NO_x emission concentrations ranging from 1.0 mg/Nm³ to 760.0 mg/Nm³ and emission loads ranging from 0.008 kg/h to 16 kg/h.

Only three plants in the data collection reported the use of iron and steel process gases instead of natural gas, namely plants 129 HDC1 (using 100% BOF), plants 37 HDC3 and 179 HDC1 (using 100% COG). For plant 129 HDC1, the reported NO_x emission concentrations were within the range 150 to 250 mg/Nm³ whereas for plant 37 HDC3 the NO_x emission concentrations ranged from 200 mg/Nm³ to 700 mg/Nm³. NO_x emissions from plant 179 HDC1 were somewhat higher within the range 300 mg/Nm³ to 1050 mg/Nm³.

To evaluate the potential influence of air-preheating temperatures on the observed concentration of NO_x emissions to air, additional figures have been prepared. Figure 5.18 and Figure 5.19 show the reported data on NO_x emissions to air from feedstock heating without air preheating and with air preheating, respectively.

CO emissions

The reported data on CO emissions to air from feedstock heating of sheet and wire hot dip coating plants (heat treatment before dipping and galvannealing) are shown in Figure 5.20. In total, 17 plants (37 emission points) reported using 100% natural gas and reported CO emission concentrations within the range 0.1 mg/Nm³ to 515 mg/Nm³ with emission load ranging from 0.006 kg/h to 6.0 kg/h.

Only two plants in the data collection reported the use of iron and steel process gases instead of natural gas, namely plants 129 HDC1 (using 100% BOF) and 37 HDC1 (using 100% COG). For plant 129 HDC1, CO emission concentrations ranged from 10 mg/Nm³ to 100 mg/Nm³ whereas for plant 37 HDC1, the reported CO emission concentrations were within the range 90 mg/Nm³ to 2 538 mg/Nm³.

5.3.5.2 Emissions to air from degreasing

Fumes generated in degreasing and brushing are collected and scrubbed, using water or sodium hydroxide (caustic soda) solution or led via a demister without scrubbing.

TVOC emissions

Data were reported on TVOC emissions to air from degreasing of sheet for one plant only in 2014 (with two emissions points), emissions are shown in Figure 5.21. For this plant, the TVOC emissions were within the range 2 mg/Nm³ to 18 mg/Nm³.

5.3.5.3 Emissions to air from pickling

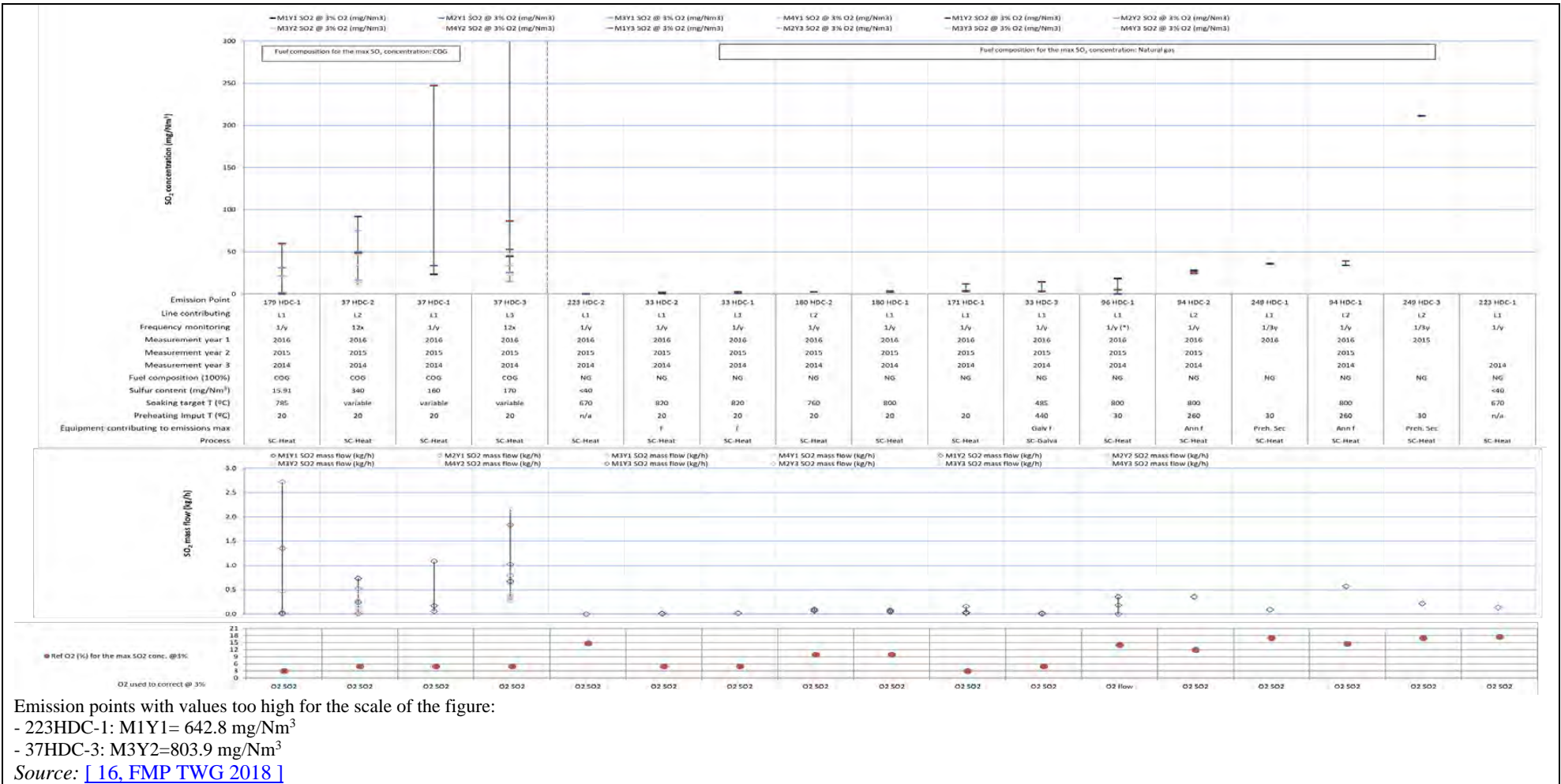
Reported data on dust and HCl emissions to air from pickling in hot dip coating can be found in the respective section for cold rolling see Section 3.3.5.3. Data are presented together because the processes are similar.

5.3.5.4 Figures with air emission levels

The emission concentrations presented in this section refers to emissions to air from feedstock heating (heat treatment before dipping and galvannealing). These figures are composed of several sections. The upper part of the figure always shows all the emission concentrations reported by the plants for each of the three reporting years. For combustion processes (heat treatment), the plotted concentration values always refer to an oxygen reference level of 3 %. Measurements reported without giving information about the oxygen level measured or the fuel composition used are not taken into account. Below the x-axis, additional contextual information is included such as for example the emission point code, the monitoring frequency, the year of measurements, the fuel composition (natural gas or other), information about air preheating including the air preheating temperature, the soaking temperature. Below the contextual information section of the figure, details on the applied BAT candidates for each line is provided. In the lower part of the figure, additional information may be also given such as the mass flow values, both for the maximum concentration obtained over the reporting period and the average mass flow over the three reporting years. Typically, cases where 100 % natural gas is used and cases where fuels other than 100 % natural gas are used are clearly indicated in the graphs. In the case of figures related to NO_x emissions, an additional graph showing the corresponding emissions of CO is provided in the lower part of the figure. In all cases, the figures are sorted in ascending order of the maximum concentration values for the three operating years. The explanations for the abbreviations used in the graphs can be found in the glossary.



Figure 5.15: Dust emissions from feedstock heating of sheet (in mg/Nm³ at 3 % oxygen)



Emission points with values too high for the scale of the figure:

- 223HDC-1: M1Y1= 642.8 mg/Nm³

- 37HDC-3: M3Y2=803.9 mg/Nm³

Source: [16, FMP TWG 2018]

Figure 5.16: SO₂ emissions from feedstock heating of sheet (in mg/Nm³ at 3 % oxygen)

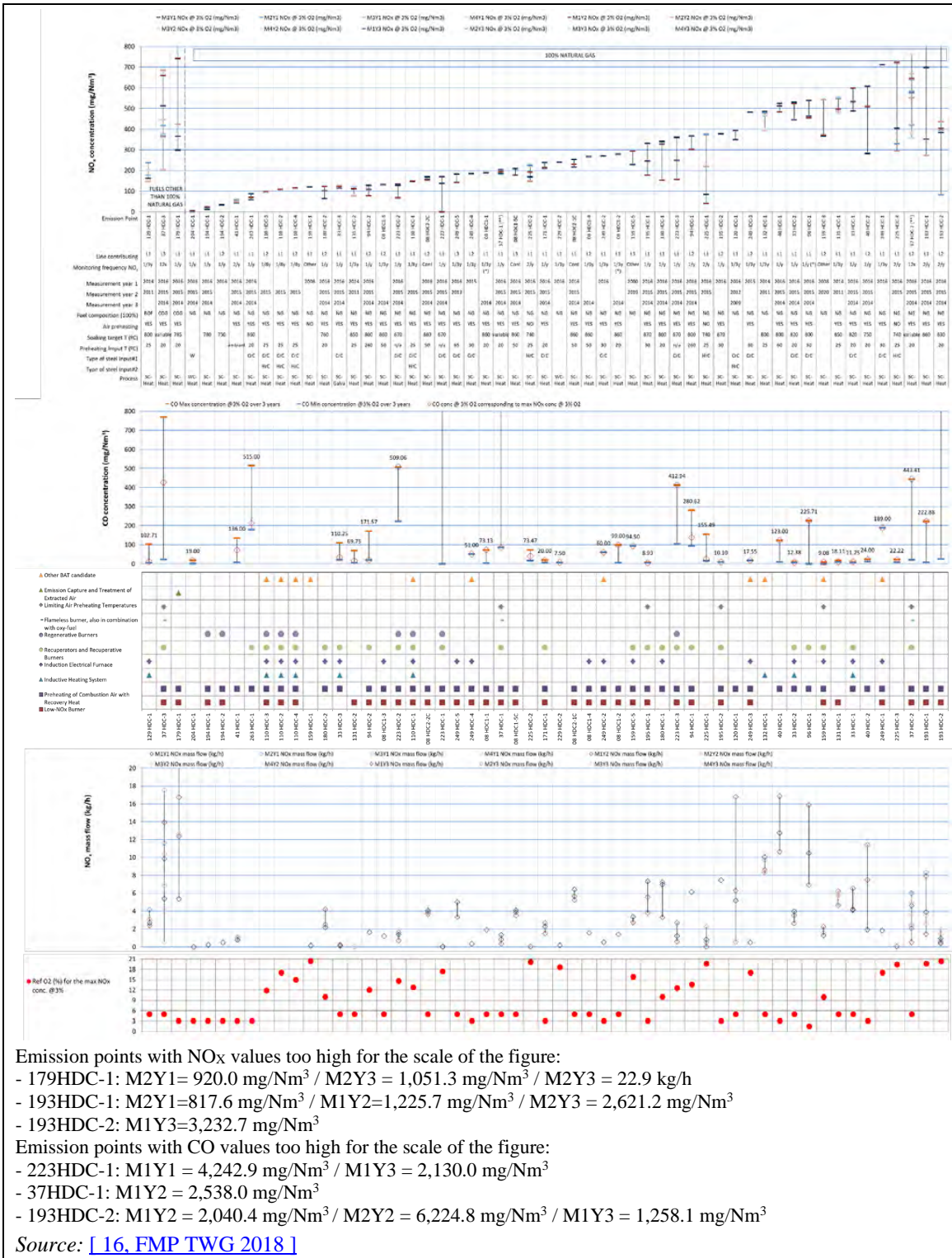
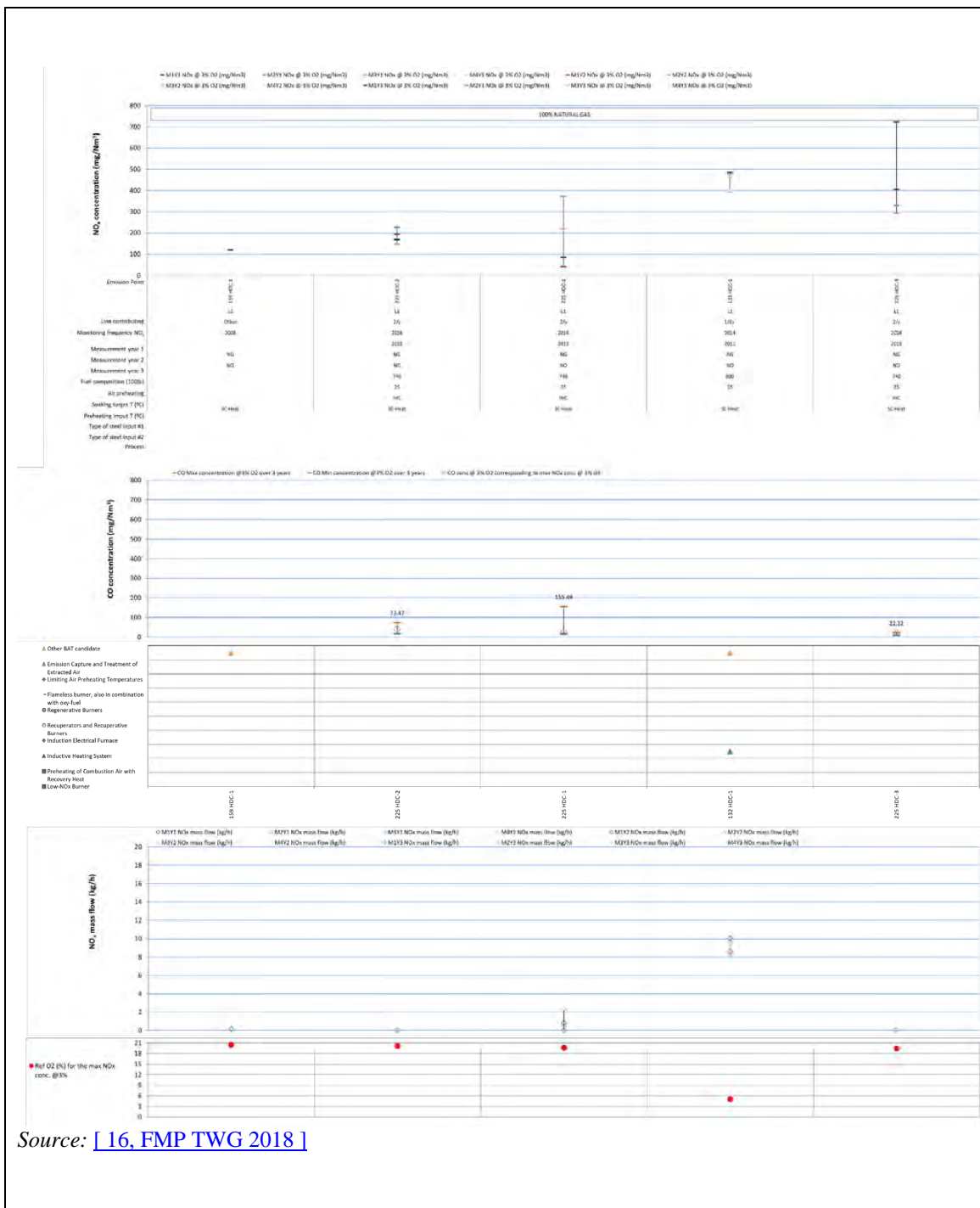


Figure 5.17: NO_x and CO emissions from feedstock heating of sheet and wire (in mg/Nm³ at 3% oxygen)



Source: [16, FMP TWG 2018]

Figure 5.18: NO_x and CO emissions from feedstock heating of sheet and wire without air preheating (in mg/Nm³ at 3 % oxygen)

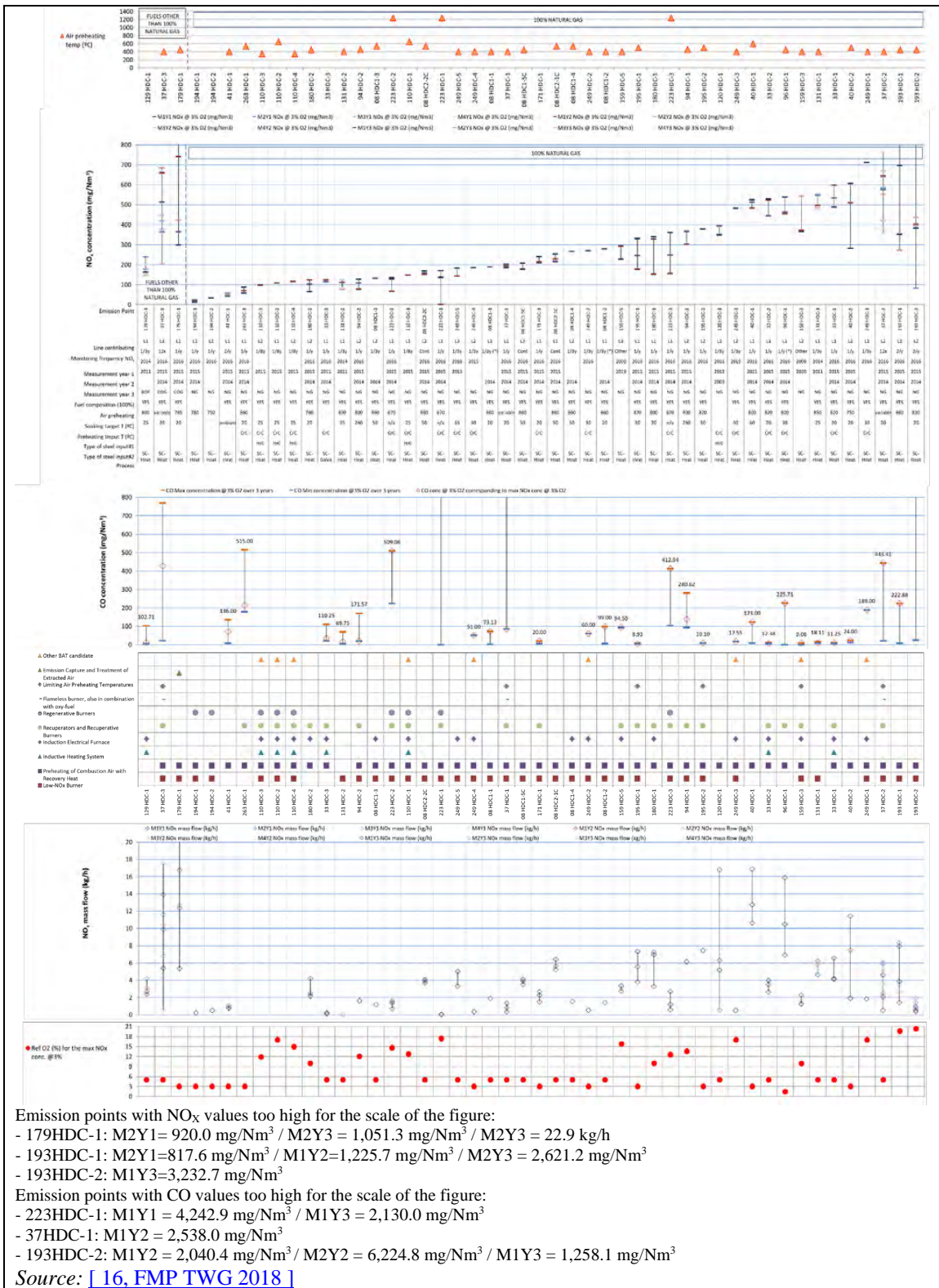


Figure 5.19: NO_x and CO emissions from feedstock heating of sheet and wire with air preheating temperature, feedstock inlet and target temperatures (in mg/Nm³ at 3 % oxygen)

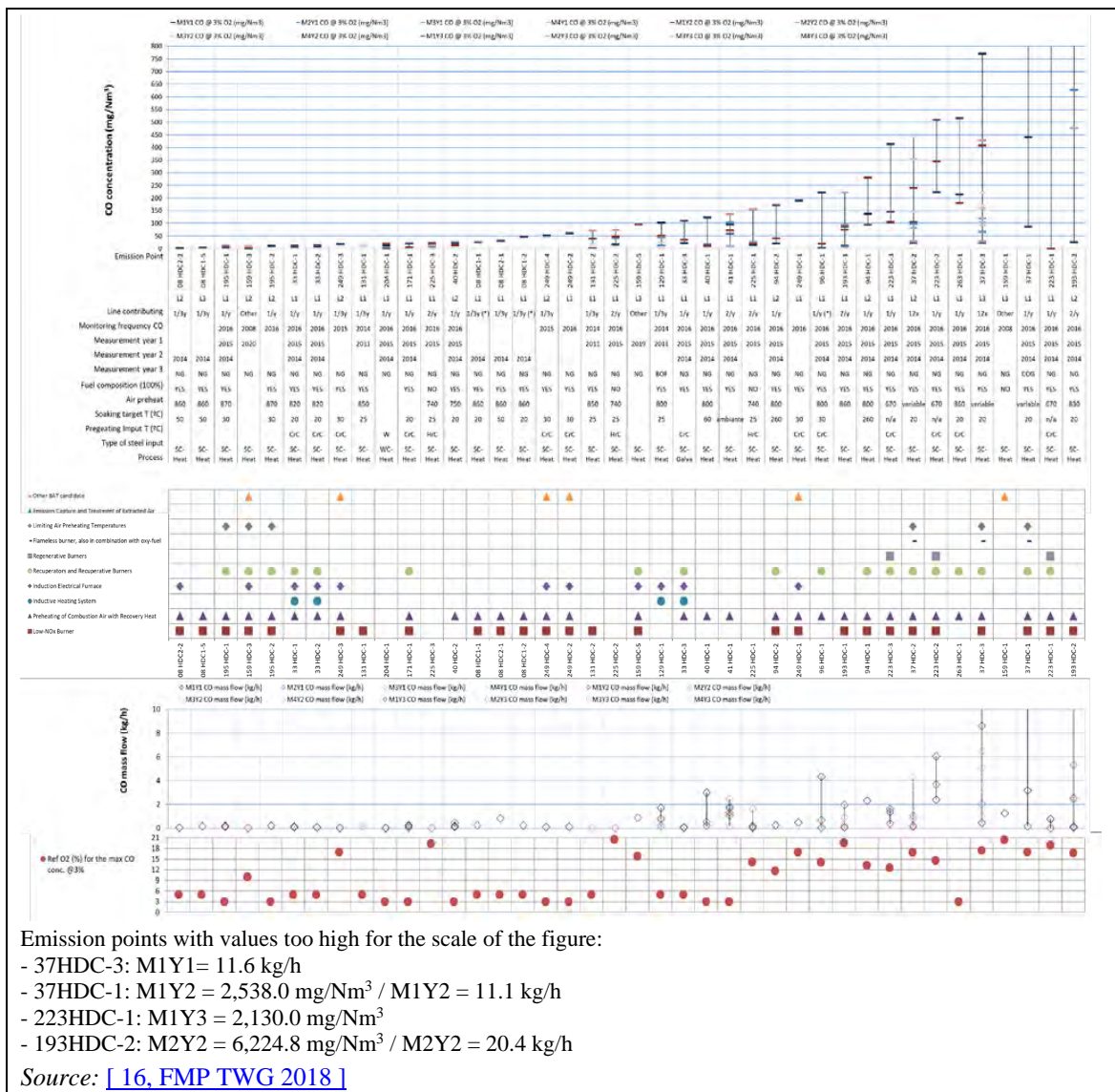
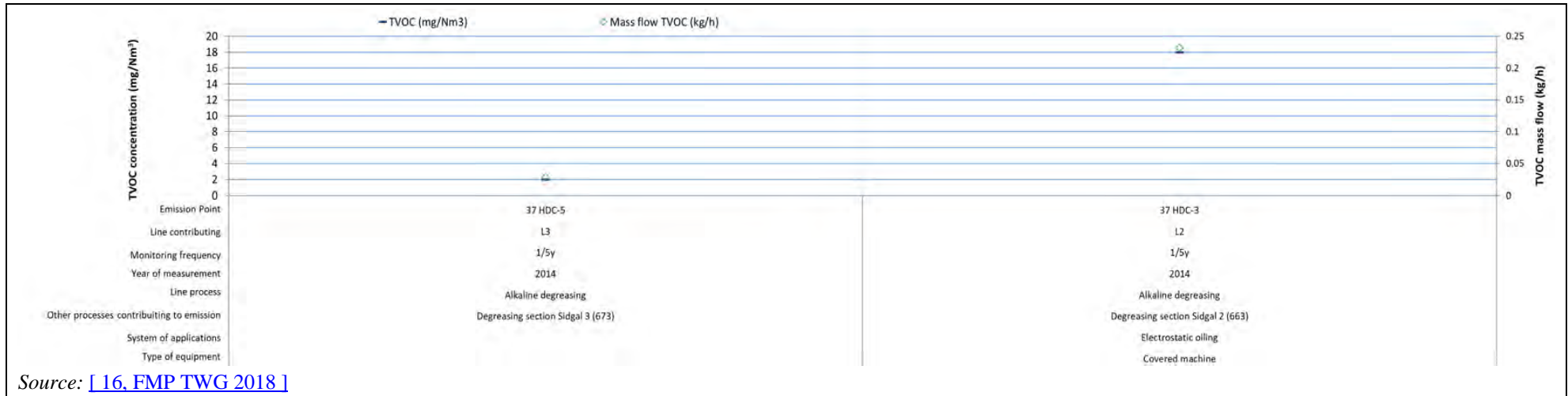


Figure 5.20: CO emissions from feedstock heating of sheet and wire (in mg/Nm³ at 3 % oxygen)



Source: [16, FMP TWG 2018]

Figure 5.21: TVOC emissions from degreasing of sheet

5.3.6 Emissions to water

All the data related to emissions to water from HDC processes are presented in Section 7.2.1 of the document where figures depicting emissions to water for all sectors are presented in a merged format.

5.3.7 Residues

Degreasing solutions are generally regenerated and recirculated to the degreasing baths. Oils are separated from the baths and the composition of the alkali solution is re-adjusted. Sometimes the solution is treated in an emulsion separation step and then biologically treated. [127, [Continuous Coating Shadow Group 1999](#)]

Oil separated from the alkali solution can be used as fuel for the production of heat.

Spent degreasing agent and waste water from the rinsing and brushing operation can also be regenerated and recycled back into the process. Therefore, magnetic filters are used to remove iron fines and ultrafiltration units are implemented for the oil phase separation. The permeate can be reused in the cascade degreasing process. The concentrate from ultrafiltration is further thickened and reused in a thermal utilisation or externally disposed of. [129, [EUROFER 2019](#)]

Waste generated by galvanising are bath splashes and dross formed in the bath.

Table 5.3 shows the reported data on the generation of hard zinc (zinc dross) for three operating years in hot dip coating plants of the FMP data collection.

Table 5.3: Zinc dross generation

Plant code	Type of product	Steel category	Specific amount of zinc dross (kg/t)			Recycle in plant	EWC code	Classification
			2016	2015	2014			
171 HDC	Galvanised	CS-C	3.54	4.10	3.66	No	11 05 01	Non-hazardous
225 HDC	Galvanised	CS-H	2.73	2.83	2.43	NI	11 05 01	Non-hazardous
229 HDC	Galvanised	CS-H	11.20	NI	NI	No	11 05 01	Non-hazardous

NB: NI = No information.
 CS-C = CS-Cold rolled products others than automotive.
 CS-H = CS-Hot rolled products.
 Source: [16, [FMP TWG 2018](#)]

5.4 Techniques to consider in the determination of BAT for continuous hot dip coating

This section describes techniques (or combinations thereof), and associated monitoring, considered to have the potential for achieving a high level of environmental protection in the activities within the scope of this document. The techniques described will include both the technology used and the way in which the installations are designed, built, maintained, operated and decommissioned.

It covers environmental management systems as well as process-integrated and end-of-pipe techniques. Waste prevention and management, including waste minimisation and recycling procedures, are also considered, as well as techniques that reduce the consumption of raw materials, water and energy by optimising use and reuse. The techniques described also cover the prevention or limiting of the environmental consequences of accidents and incidents. They also cover the prevention or reduction of emissions under other than normal operating conditions (such as start-up and shutdown operations, leaks, malfunctions, momentary stoppages and the definitive cessation of operations).

Annex III to the Directive lists a number of criteria for determining BAT, and the information within this chapter will address these considerations. As far as possible, the standard structure in Table 2.15 is used to outline the information on each technique, to enable a comparison of techniques and the assessment against the definition of BAT in the Directive.

This chapter does not necessarily provide an exhaustive list of techniques that could be applied in the sector. Other techniques may exist, or may be developed, which could be considered in the determination of BAT for an individual installation.

In Chapter 8 general techniques (i.e. those used that are commonly used) are discussed which might also be applicable to continuous hot dip coating. These techniques are normally not repeated in this section, unless information specific for this sector was made available.

5.4.1 Galvanising of sheet

5.4.1.1 Degreasing

5.4.1.1.1 Reverse cascade degreasing

Description

Degreasing is carried out in two or more baths in series where the feedstock is moved from the most contaminated degreasing bath to the cleanest.

Technical description

The solution is used in previous degreasing steps, for example the solution from the electrolytic degreasing section is reused in the spray section, once a certain oil level is reached. The spent degreasing solution of the spray section is sent away to be regenerated. The oil residues from the regeneration devices are incinerated off site, and the rinse waters are treated in the main water treatment plant. Leakages and splashes are collected and treated.

Achieved environmental benefits

- Reduced degreasing solution consumption (fresh water consumption).
- Reduction of waste water and sludge in the water treatment plant. [[127, Continuous Coating Shadow Group 1999](#)]

Environmental performance and operational data

A total of 15 m³/h of demineralised water is needed for a production yield of 68 t/h. [[127, Continuous Coating Shadow Group 1999](#)]

Cross-media effects

Increased energy consumption. [127, Continuous Coating Shadow Group 1999]

Technical considerations relevant to applicability

Generally, there are no technical restrictions to the applicability of this technique.

Economics

Investment costs are medium and operating costs are low. [127, Continuous Coating Shadow Group 1999]

Driving force for implementation

No information provided.

Example plants

Plants from the data collection: 08 HDC, 33 HDC, 37 HDC, 94 HDC, 96 HDC, 110 HDC, 123 HDC, 129 HDC, 159 HDC, 180 HDC, 193 HDC, 195 HDC, 249 HDC.

Reference literature

[16, FMP TWG 2018], [127, Continuous Coating Shadow Group 1999].

5.4.1.1.2 Cleaning and reuse of the degreasing solution**Description**

Physical treatment (e.g. magnetic separation, oil separation, micro- or ultrafiltration) is used to clean the degreasing solution for reuse.

Technical description

In general, fresh water is added against the travel direction of the strip. The amount of fresh water is added to make up the evaporation losses of water in the spray cleaning after the electrolytic cleaning section in such a way that a minimum of overflow into the electrolytic cleaning section is established. Thus this fresh water is added towards the two recirculation circuits (alkaline and electrolytic degreasing). About 25 % of the circulated degreasing solution is treated in a separate flow, e.g. by magnetic separation, oil separation, micro or ultrafiltration. Part of this flow is periodically sent to the waste water treatment plant. The rods of the magnetic separator are cleaned by a scrubbing robot. The resulting iron fines are collected separately.

Figure 5.22 shows an example of a degreasing solution circuit.

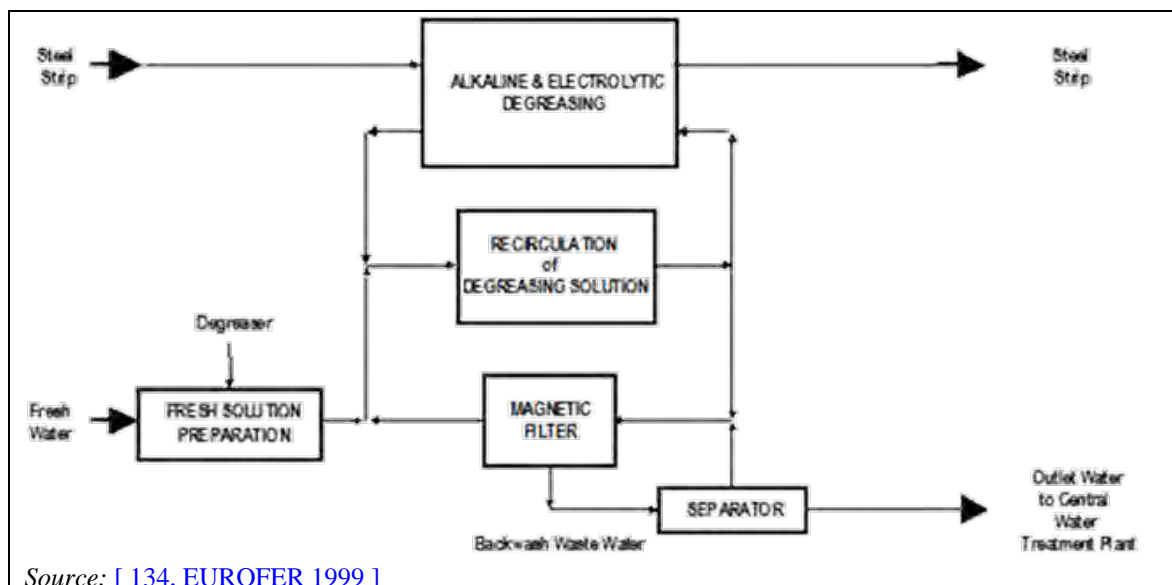


Figure 5.22: Example of a degreasing solution recycling system

For more detailed information see Section 8.6.1.5.

Achieved environmental benefits

- Reduction of alkaline chemical consumption. [[127, Continuous Coating Shadow Group 1999](#)]
- Reduction of water volume and sludge volume in the water treatment plant. [[127, Continuous Coating Shadow Group 1999](#)]

Environmental performance and operational data

Water consumption of 5 m³/h is needed for a production yield of 68 t/h. [[127, Continuous Coating Shadow Group 1999](#)]

Cross-media effects

Energy consumption. [[127, Continuous Coating Shadow Group 1999](#)]

Technical considerations relevant to applicability

Generally, there are no technical restrictions to the applicability of this technique.

Economics

High investment and operational costs. [[127, Continuous Coating Shadow Group 1999](#)]

Driving force for implementation

- Mainly product requirements.
- Quality of incoming coils (iron and oil residuals) can be also a driving element.

Example plants

Plants from the data collection: 08 HDC2, 33 HDC, 37 HDC, 40 HDC, 94 HDC, 96 HDC, 110 HDC, 123 HDC, 129 HDC, 132 HDC, 159 HDC, 179 HDC, 180 HDC, 193 HDC, 194 HDC, 195 HDC, 08 HDC1, 08 HDC2, 193 HDC, 194 HDC, 195 HDC, 249 HDC.

Reference literature

[[16, FMP TWG 2018](#)], [[25, EUROFER 2018](#)], [[127, Continuous Coating Shadow Group 1999](#)].

5.4.1.1.3 Use of a direct-flame furnace in the case of hot dip coating of steel sheets

Description

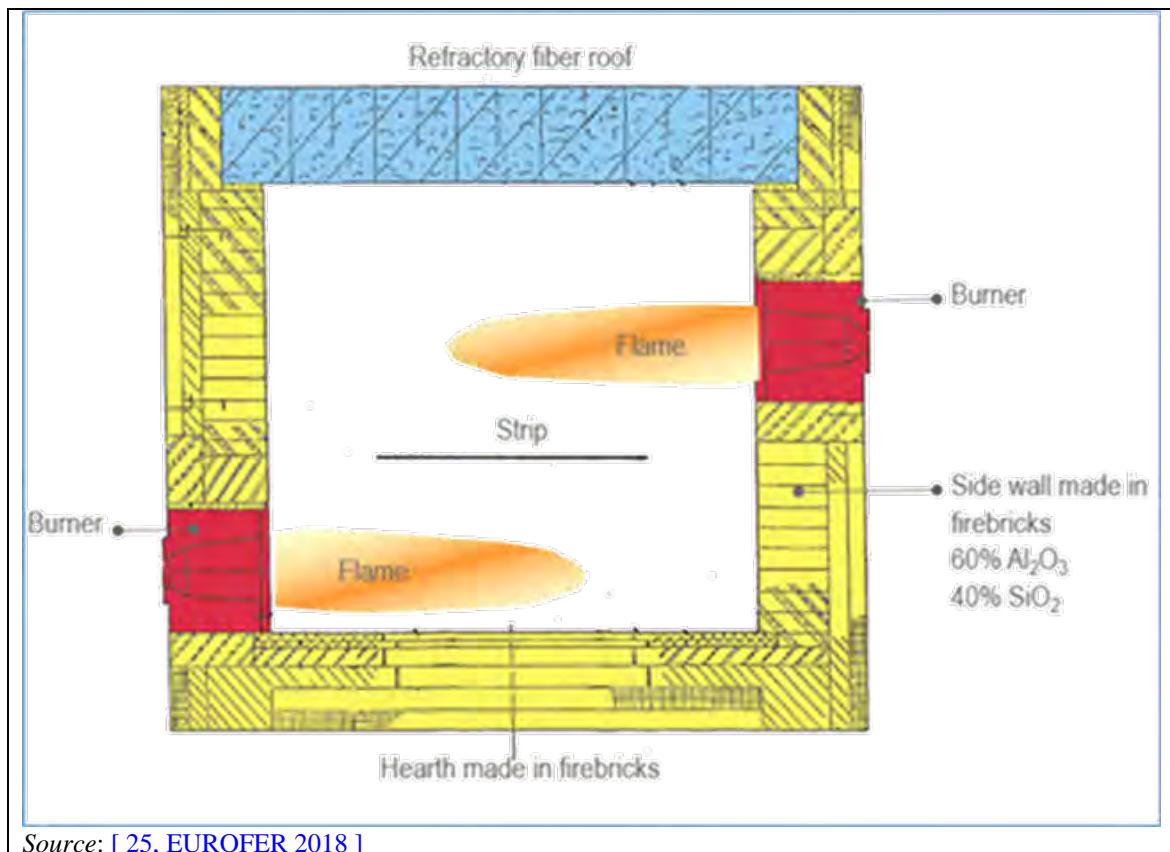
The oil on the surface of the steel sheet is burnt in a direct-flame furnace. Degreasing before the furnace may be necessary for some high-quality products or in the case of steel sheets with high residual oil levels.

Technical description

Annealing furnaces on galvanising lines equipped with a DFF (direct-flame furnace) have the additional function of cleaning the strip of surface contaminants (this occurs in the DFF section). In this specific furnace configuration, most of the heating occurs in the DFF where the gas is a mixture of natural gas and air with a super-stoichiometric air/gas ratio ($\Lambda < 1$). The gas burners in the DFF are normally arranged asymmetrically to ensure uniform heating of the strip surface (See Figure 5.23). The strip enters the DFF at room temperature or higher if there is a preheating section (normally preheating is achieved by counter flow of combustion fumes) and exits the DFF at temperatures in the range of 500–800 °C.

In summary:

- carbon residues are burnt (atmosphere even oxidising for iron);
- chemical degreasing can be used to ensure constant surface carbon; variable surface carbon may change the Fe oxidation kinetic, affecting the emissivity differently, and so the way the furnace is operating.



Source: [25, EUROFER 2018]

Figure 5.23: Schematic of a direct-flame furnace

Achieved environmental benefits

- No emissions to water. [127, Continuous Coating Shadow Group 1999]
- No generation of waste. [127, Continuous Coating Shadow Group 1999]

Environmental performance and operational data

In some cases, it might still be necessary to have a degreasing section before the furnace for some high-quality appliances or in the case of incoming coils with a high residual level of oil. The furnace is not as easy to control as a radiant tube furnace. Fumes from the furnace are normally used to preheat incoming gas and combustion air with a dedicated heat exchanger. [127, Continuous Coating Shadow Group 1999]

Cross-media effects

Emissions to air through the burning of oil. [127, Continuous Coating Shadow Group 1999]

Technical considerations relevant to applicability

Applicability may be limited if a very high level of surface cleanliness and zinc adhesion is required.

Economics

Investment and operating costs are reduced because there is no need for preceding sections. [204, ES, TWG member 1999]

It is cheap to operate and install. [127, Continuous Coating Shadow Group 1999]

Driving force for implementation

Cost (see economics above).

Example plants

Plants from the data collection: 110 HDC, 131 HDC, 158 HDC, 223 HDC, 249 HDC.

Reference literature

[127, Continuous Coating Shadow Group 1999].

5.4.1.1.4 Squeeze rolls

Description

Squeeze rolls are used before the steel strip leaves the treatment section to ensure minimal drag-out of solution into the next section.

Technical description

The remaining degreasing solution or rinse water on the steel strip is removed from the strip by squeeze rolls before leaving each treatment section. This will assure that drag-out of solution into the next section is minimised and loss of chemicals and contamination of rinse water are also minimised. [127, Continuous Coating Shadow Group 1999] Different types of squeeze rolls are available (e.g. non-woven, rubber). (EUROFER comments in [24, TWG 2019])

Figure 5.24 shows an example of a chemical pretreatment section of a hot dip galvanising line for sheet using squeeze rolls and cascade rinsing (for efficient rinse water use).

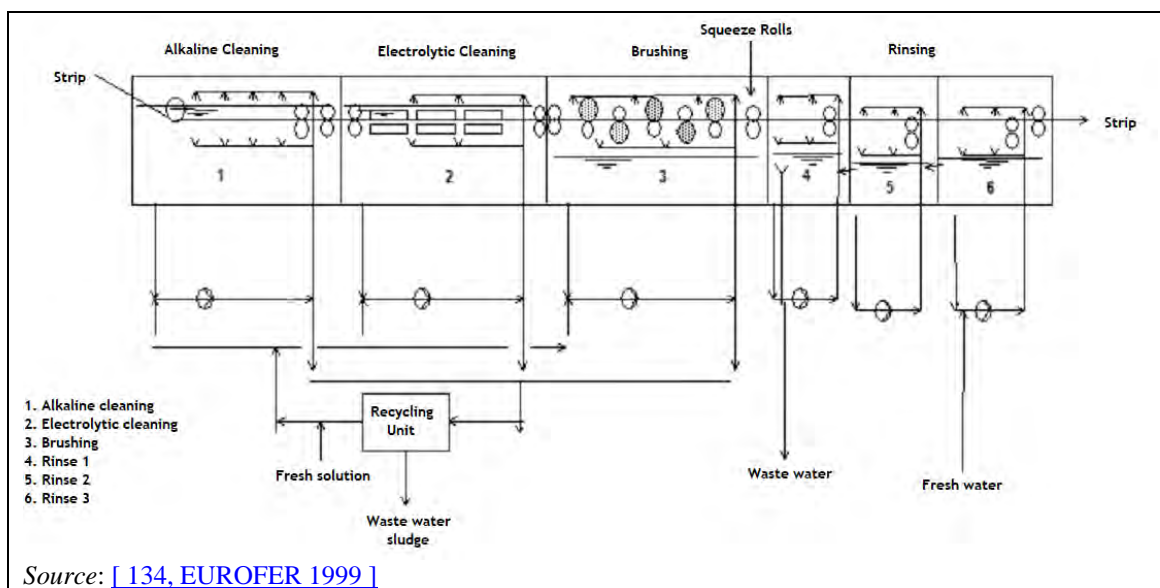


Figure 5.24: Chemical pretreatment section for a sheet hot dip coating line (example)

Achieved environmental benefits

- Reduction of raw materials consumption. [127, Continuous Coating Shadow Group 1999]
- Reduction of waste water volume and of sludge in the waste water treatment plant. [127, Continuous Coating Shadow Group 1999]

Environmental performance and operational data

Non-woven squeeze rolls are reported to have a longer lifespan than rubber rolls, resulting in reduced changeover frequency and reduced downtime. (EUROFER comments in [24, TWG 2019])

Technical considerations relevant to applicability

Generally, there are no technical restrictions to the applicability of this technique for flat products.

Cross-media effects

None. [\[127, Continuous Coating Shadow Group 1999 \]](#)

Economics

The initial investment is not high and the operating cost is low. [\[127, Continuous Coating Shadow Group 1999 \]](#)

Driving force for implementation

No information provided.

Example plants

Plants from the data collection: 08 HDC, 33 HDC, 37 HDC, 40 HDC, 94 HDC, 96 HDC, 110 HDC, 123 HDC, 129 HDC, 159 HDC, 180 HDC, 193 HDC, 194 HDC, 195 HDC, 249 HDC.

Reference literature

[\[16, FMP TWG 2018 \]](#), [\[127, Continuous Coating Shadow Group 1999 \]](#).

5.4.1.2 Heat treatment

See Section 8.5.3 and Section 8.8 for techniques related to energy efficiency and emissions to air, respectively.

5.4.1.2.1 Inductive heating system**Description**

Induction heating is used instead of gas burners for part of the heating pattern. [\[108, EUROFER 19-6-17 2017 \]](#)

Technical description

In a hot dip galvanising line, induction heaters can be installed as follows:

- At the entry of the annealing furnace in order to boost the heating process. Induction heaters increase the productivity and facilitate the temperature transients.
- After the melt pot and the air knives, in order to produce the galvannealing coating, in the case of automotive GA (galvannealed) products.
- Inside the furnace to increase the strip temperature again after the cooling section in the case of a particular annealing cycle (mainly AHSS).

The technology is composed of a solenoidal inductor with a longitudinal flux. The power supply is at very high frequency (400–450 kHz), using transistor-based inverters. The use of very high frequency, recently developed, offers the best electrical efficiency with uniform heating along the strip width.

Achieved environmental benefits

Reduction of emissions to air from gas combustion.

Environmental performance and operational data

When the inductor is placed before the furnace, the temperature is controlled in order to avoid the burning point of emulsion residuals being reached. In addition, a higher temperature is avoided to prevent massive oxidation of the strip.

In some cases, the inductor might be connected directly to the furnace (in that case it is located in a confined space with fume extraction and an inert atmosphere) but it adds technical complexity and cost and in this case the real advantage has to be evaluated.

It should also be highlighted that the efficiency of electrical heating systems depends, among others, on the temperature range.

Cross-media effects

In the event that electricity is produced by combustion, emissions to air are generated.

Technical considerations relevant to applicability

Generally, there are no technical restrictions to the applicability of this technique.

Economics

No information provided.

Driving force for implementation

No information provided.

Example plants

Galvannealing: Plants from the data collection: 33 HDC, 129 HDC, 180 HDC.

Annealing: Plants from the data collection: 129 HDC, 132 HDC.

Reference literature

[16, FMP TWG 2018], [108, EUROFER 19-6-17 2017].

5.4.1.3 Hot dipping (galvanising)

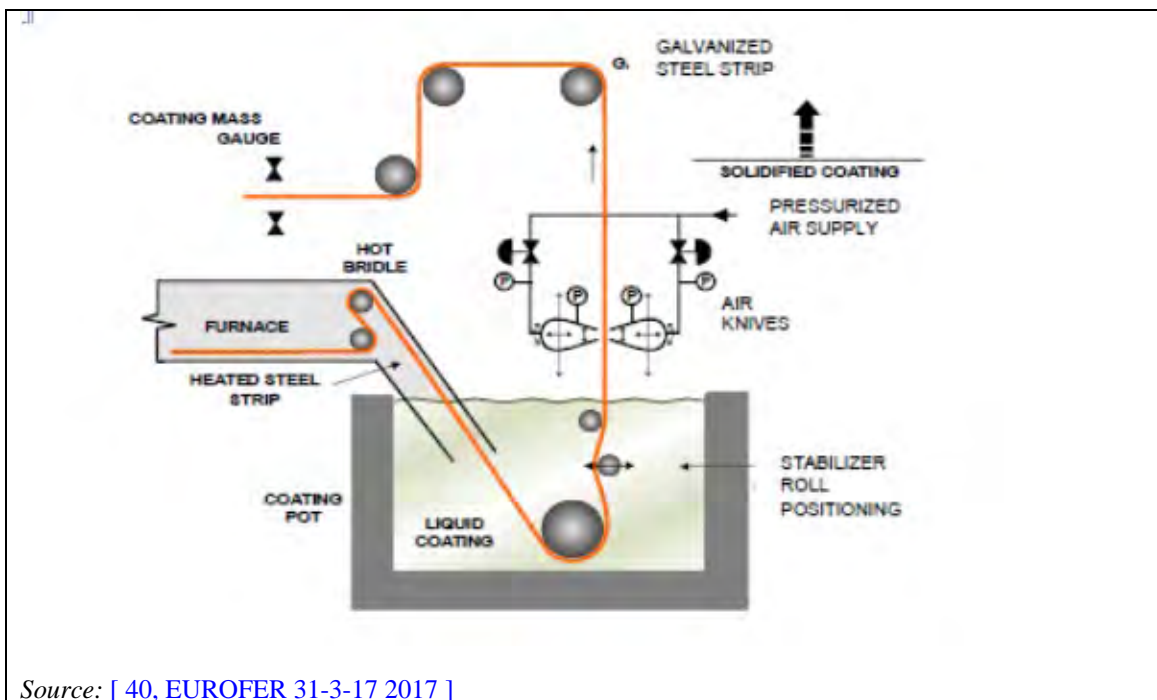
5.4.1.3.1 Air knives for coating thickness control

Description

After leaving the molten zinc bath, air jets stretching over the width of the strip blow the surplus coating metal off the strip surface back into the galvanising kettle.

Technical description

After being dipped in the molten zinc bath, the strip is blown on with the air knives.



Source: [40, EUROFER 31-3-17 2017]

Figure 5.25: Schematic of a hot dip galvanising line coating section with air knife actuators and a coating mass sensor

With a dedicated algorithm, the zinc thickness gauge feeds back the gap of the air knives to optimise the coating. This solution enables the nozzle skew movement to be adjusted automatically.

Achieved environmental benefits

Reduced consumption of coating material.

Environmental performance and operational data

No information provided.

Cross-media effects

Energy consumption.

Technical considerations relevant to applicability

Generally, there are no technical restrictions to the applicability of this technique.

Economics

No information provided.

Driving force for implementation

Improvement of the quality of the thickness of the metallic layer and therefore increase of the yield.

Example plants

Plants from the data collection: 08 HDC1, 08 HDC2, 33 HDC, 37 HDC, 40 HDC, 41 HDC, 94 HDC, 96 HDC, 110 HDC, 120 HDC, 123 HDC, 129 HDC, 131 HDC, 171 HDC, 179 HDC, 180 HDC, 193 HDC, 194 HDC, 195 HDC, 201 HDC, 204 HDC, 211 HDC, 223 HDC, 249 HDC, 263 HDC.

Reference literature

[[16, FMP TWG 2018](#)], [[127, Continuous Coating Shadow Group 1999](#)].

5.4.1.3.2 Stabilisation of the strip

Description

The efficiency of the excess coating removal by air knives is improved by limiting the oscillations of the strip, e.g. by increasing strip tension, using low-vibration pot bearings, using electromagnetic stabilisers.

Technical description

After being dipped in the molten zinc bath, the zinc-coated strip is blown on, with air knives. The electromagnetic stabiliser is applied to stabilise the strip using the electromagnetic field. The system is installed on the vertical section of the strip, after the air knives. It consists of electromagnetic actuators on both sides of the strip, installed in two specially designed housings. The number of actuators depends on the strip's width (approximately one actuator every 25 cm of width). When the strip passes between the actuators, its position is continuously measured. Every time the position deviates from the central reference position, it is corrected through specific actuators. It generates a tensile force on the strip in the active state. The strip is thus stabilised, reducing oscillations in the air knives section. Another major application for electromagnetic strip stabilisation is the installation in the cooling tower of a hot dip galvanising line. The cooling blowers may induce torsional vibration of the strip, which may result in strip contact with the blowers. Using a strip stabilisation system, these oscillations are almost completely eliminated and damage to the strip surface is actively prevented.



Source: [40, EUROFER 31-3-17 2017]

Figure 5.26: Schematic of an electromagnetic stabiliser

Achieved environmental benefits

Reduced consumption of coating material. [31, EUROFER 10-7-18 2018]

Environmental performance and operational data

Electromagnetic stabilisation comes as a last resort to improve strip stability. Many other technical aspects must be secured first, i.e. immersed bearings, pot hardware geometry, air wiping, strip tension, all of which strongly affect strip stability. The implementation of electromagnetic stabilisation cannot offset other issues, or only partially, and is therefore normally considered as the last step of the strip stability improvement plan. [3, EUROFER 2020]

The electromagnetic stabilisation implies increased maintenance efforts. In particular, if electromagnetic stabilisers are installed separately from the air knives (as shown above), the usual regular cleaning procedure of the air knives will be hindered and the cleaning efforts will increase. Integrated solutions (electromagnetic stabilisers directly combined with air knives) can avoid this drawback but require a complete system change, which is very cost-intensive.

Cross-media effects

Slightly increased energy consumption.
Increased maintenance efforts.

Technical considerations relevant to applicability

Generally applicable to strip coating.

Economics

High investment costs, especially for integrated solutions.

Driving force for implementation

The driving force for the implementation of this technique is mainly quality issues. It is especially relevant for applications with strict requirements for the zinc coating thickness.

Example plants

Thyssenkrupp Steel Europe AG Hot dip galvanising line 7.
Arcelor Mittal Sagunto - 96 HDC.
Arcelor Mittal Belgium Eurogal - 40 HDC.

Reference literature

[31, EUROFER 10-7-18 2018].

5.4.1.4 Galvannealing

5.4.1.4.1 Galvannealing treatment tower equipped with induction heating

Description

A galvannealing post-treatment process is carried out using a galvannealing treatment tower equipped with an induction furnace for reheating the cold rolled steel strip, followed by a soaking step using electrical furnaces and final cooling of the strip.

Technical description

In the galvanising process, the two faces of a cold rolled steel strip are coated with a thin layer of zinc by passing through a liquid zinc bath. The obtained zinc coating is composed of about 99.7% zinc and 0.3% iron. In the galvannealing process, it is possible to transform the initial zinc layer obtained after galvanising into an iron-zinc alloy coating containing between 8 to 12% iron.

The galvannealing process cycle consists in reheating the strip at around 500°C, for a duration of about fifteen seconds. This fast rise in temperature is achieved by passing through an induction furnace, followed by a holding furnace (usually electric). The strip is subsequently cooled down to about 150°C or below before water quenching. In the past, this was achieved using natural gas-fired galvannealing furnaces.

Figure 5.27 shows a schematic of a typical galvannealing treatment tower equipped with induction heating.

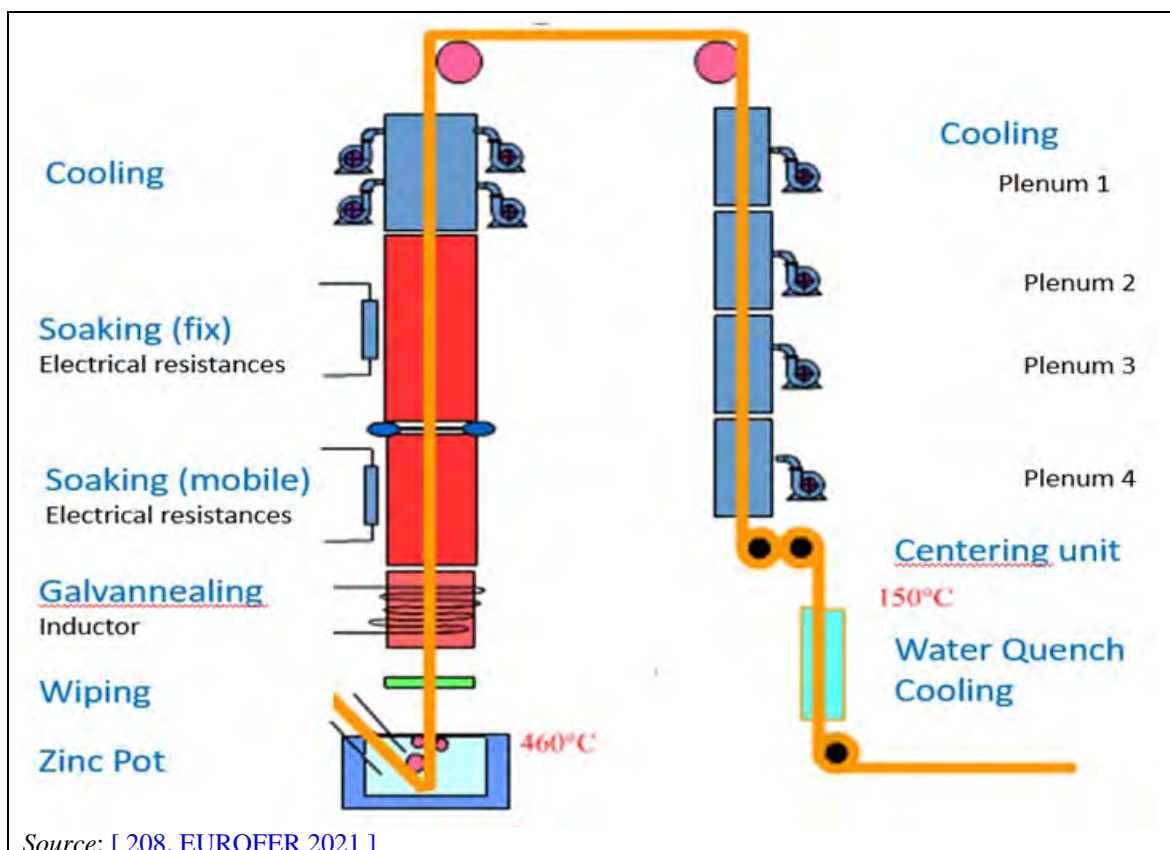


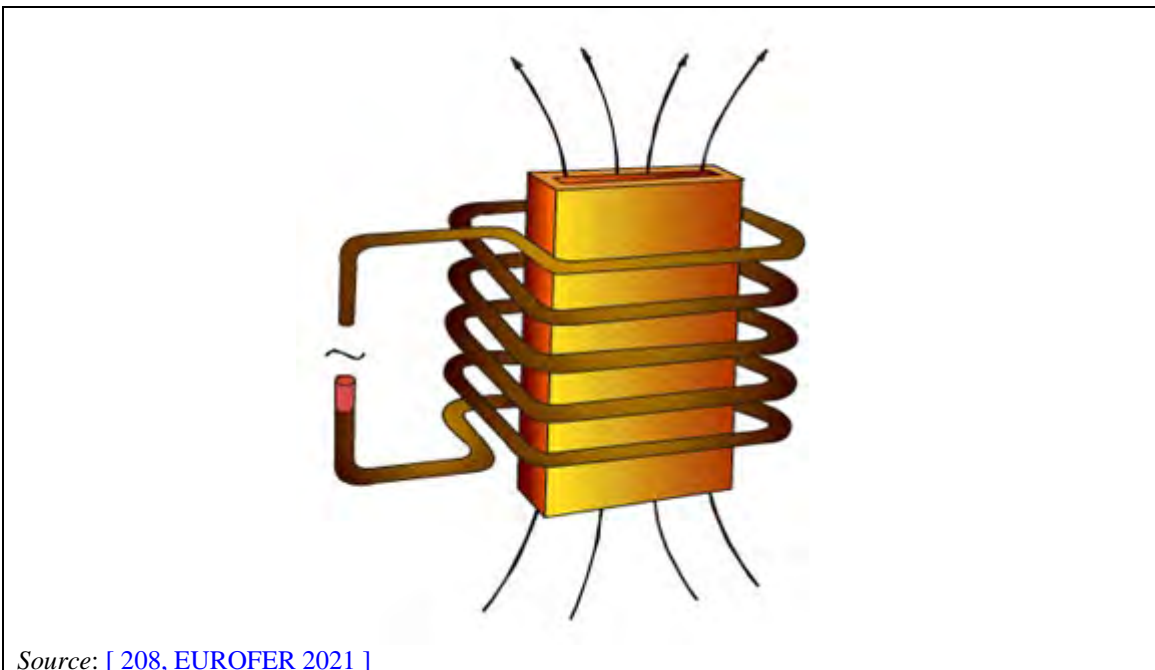
Figure 5.27: Schematic of a galvannealing treatment tower equipped with induction heating

Induction heating is achieved using a longitudinal flow induction furnace as shown in Figure 5.28. Induction heating provides an energy transfer from the inductor coil (solenoid) to the strip

to be heated using an electromagnetic field, which dissipate heat by Joule effect in the strip. Key parameters to control related to the induction furnace are:

- the frequency of the current;
- the nature of the material and its condition (temperature);
- the inductor field;
- the type of inductor and its geometric characteristics;
- the nature of the conductors used in the inductor.

In general, the higher the frequency is, the lower the skin thickness is (thickness on the surface of the metal sheet in which the current circulates). The inductor is usually made of electrolytic copper to minimise losses by Joule effects and is water-cooled. Induction furnaces are very sensitive to zinc dust which may trigger short circuits and therefore they need to be cleaned regularly. The coils are usually protected internally by insulating plates. The distance between the coil and the strip is between 100 and 200 mm.



Source: [208, EUROFER 2021]

Figure 5.28: Schematic of the galvannealing induction furnace

The galvannealing cycle allows, initially, the diffusion of zinc into the steel substrate in order to break an inhibition layer of Fe_2Al_5 . After breaking this layer, the iron can diffuse further into the zinc coating to form the required iron-zinc alloys (with about 10% iron content at the end of the cycle).

Galvannealed steel also holds a zinc coating that is stronger compared to many other types of galvanised steel which increases the product resistance to scratching. Also, galvannealed steels shows good formability and weldability compared to other types of galvanised steel.

Achieved environmental benefits

- Galvannealing induction furnaces are much more energy efficient than natural gas-fired galvannealing furnaces where heating is done by convection, and to a lesser extent radiation. The yield of such furnace is very poor (10 to 15% at most) because liquid zinc is very reflective (emissivity of the order of 0.1).
- Compared to induction furnaces, the heating speed of gas-fired furnaces is rather low and the furnace height is therefore quite high. The furnace height is generally limited to about 55 m to avoid problems of band vibration resulting in very short soaking times.

- Compared to induction furnaces, gas-fired furnaces have a significant inertia that does not allow frequent changes in settings.

Environmental performance and operational data

In total, three plants in the data collection reported information on the operation and environmental performance of the galvannealing process step.

Plant 33 HDC:

- Type of heating: Induction heating combined with direct flame burners (natural gas)
- Input temperature of strip (heating step): 440°C
- Target temperature of strip (Heating step): 485°C
- Input temperature of strip (Soaking step): 485°C
- Target temperature of strip (Soaking step): 485°C
- Input temperature of strip (Cooling step): 485°C
- Target temperature of strip (Cooling step): 50°C
- Emissions data: Dust (from 2.7 to 9.5 mg/Nm³), NO_x (from 102 to 110 mg/Nm³), SO₂ (from 2.6 to 12.8 mg/Nm³), CO (from 19 to 98 mg/Nm³)

Plant 129 HDC:

- Type of heating: Induction heating only
- Input temperature of strip (heating step): 450°C
- Target temperature of strip (Heating step): 550°C
- Input temperature of strip (Soaking step): 550°C
- Target temperature of strip (Soaking step): 550°C
- Input temperature of strip (Cooling step): 550°C
- Target temperature of strip (Cooling step): Not specified
- Emissions data: No emission data reported.

Plant 180 HDC:

- Type of heating: Induction heating only
- Input temperature of strip (heating step): 460°C
- Target temperature of strip (Heating step): 500°C
- Input temperature of strip (Soaking step): Not specified.
- Target temperature of strip (Soaking step): Not specified
- Input temperature of strip (Cooling step): 500°C
- Target temperature of strip (Cooling step): 300°C
- Emissions data: No emission data reported.

Cross-media effects

None reported.

Technical considerations relevant to applicability

Generally applicable.

Economics

No information provided.

Driving force for implementation

Energy efficiency.

Example plants

Plants from the data collection: 33 HDC, 129 HDC, 180 HDC.

Reference literature

[[208, EUROFER 2021](#)].

5.4.1.5 Post-treatments

5.4.1.5.1 Cleaning and reuse of the phosphating or passivation solution

Description

A cleaning circuit, for example with filtration, is used to clean the phosphating or passivation solution for reuse.

Technical description

The hot dip coating chemical post-treatment section is usually equipped with a preparation tank (large volume) and a working tank (small volume). In the preparation tank, the chemical mixture is prepared and checked. Then, a small part is sent to the working tank which is refilling the preparation tank regularly when the level is going down. Only the liquid in the working tank enters in contact with the strip and can become polluted. However, as it is continuously consumed, the level of contamination is very low. As a consequence, there is no real need for a complex system for cleaning the solution: simple filters are sufficient. [[3, EUROFER 2020](#)]

Phosphating solution

Generally, the phosphate solution is filtered through filters while recirculated. Only a small amount of exhausted solution is discharged from time to time and treated externally. The waste water from the rinsing section is also treated externally in the water treatment plant. This treatment may also be carried out off site. [[127, Continuous Coating Shadow Group 1999](#)]

Chemically phosphated steel strips are produced inline in a hot dip galvanising line. The phosphating solution is either (i) applied through a spray header onto the top and bottom sides (excess wet film is wiped off by means of hard-rubber rollers) or (ii) supplied with chemcoater of the bare hot dip galvanised strip. The wet film is subsequently dried in a hot-air dryer. [[25, EUROFER 2018](#)]

Passivation solution

The passivation solution is filtered through filters while recirculated. Occasionally, the exhausted solution is discharged and treated externally in the water treatment plant or off site. Chemically passivated steel strips are produced inline in a hot dip galvanising line. The passivation solution is either (i) applied through a spray header onto the top and bottom sides (excess wet film is wiped off by means of hard-rubber rollers) or (ii) supplied with chemcoater of the bare hot dip galvanised strip. The wet film is subsequently dried in a hot-air dryer. [[25, EUROFER 2018](#)]

The choice whether a hot dip galvanised steel strip is phosphated or passivated or remains untreated depends on the customer's product specification regarding paintability, weldability, formability, corrosion resistance. In the case of the automotive industry, usually the whole car body is phosphated before painting. [[25, EUROFER 2018](#)]

Achieved environmental benefits

- Reduction of phosphating and passivation chemical consumption. [[127, Continuous Coating Shadow Group 1999](#)]
- Reduction of water outlets and volume of sludge in the water treatment plant. [[127, Continuous Coating Shadow Group 1999](#)]

Environmental performance and operational data

For phosphating solutions, it is necessary to control the following process parameters: conductivity and/or the density of the phosphating bath. The layer thickness would be controlled off line using X-ray fluorescence methods or using wet chemical methods. In wet chemical analysis, the layer thickness is measured indirectly from the phosphorus content of the stripping solution. [[25, EUROFER 2018](#)]

For passivation solutions, it is necessary to control the following process parameters: conductivity and/or the density of the passivation bath. The layer thickness would be controlled off line using X-ray fluorescence methods or using wet chemical methods. In wet chemical analysis, the layer thickness is measured indirectly from a marker element of the stripping solution which depends on the passivation method used. [25, EUROFER 2018]

Cross-media effects

Energy consumption [127, Continuous Coating Shadow Group 1999]

Waste generation: Depositions may occur in the phosphating and passivation baths which needs to be disposed of. [25, EUROFER 2018]

Technical considerations relevant to applicability

Generally, there are no technical restrictions to the applicability of this technique.

Economics

The investment and operating costs are medium [127, Continuous Coating Shadow Group 1999]

Driving force for implementation

Reduced consumption of chemicals.

Example plants

Plants applying phosphating: 33 HDC, 129 HDC, 180 HDC.

Plants applying passivation: All five hot dip galvanising lines at Voestalpine Stahl GmbH - Plants 08 HDC1 and 08 HDC2.

Other plants in the FMP data collection applying passivation are: 37 HDC, 40 HDC, 41 HDC, 94 HDC, 96 HDC, 120 HDC, 129 HDC, 131 HDC, 132 HDC, 159 HDC, 180 HDC, 193 HDC, 194 HDC, 195 HDC, 223 HDC, 249 HDC, 263 HDC.

Reference literature

[3, EUROFER 2020], [16, FMP TWG 2018], [25, EUROFER 2018], [127, Continuous Coating Shadow Group 1999].

5.4.1.5.2 Air extraction as close as possible to the source from chemical baths or tanks in post-treatment (i.e. phosphating and passivation)

Description

Emissions from the chemical tanks and chemical baths are captured, e.g. by using one or a combination of the following techniques:

- lateral hood or lip extraction;
- tanks equipped with moveable lids;
- enclosing hoods;
- placing the baths in enclosed areas.

The captured emissions are then extracted and treated either by wet scrubbing or by demister.

Technical description

See Sections 8.8.1.1 and 8.8.1.7 for the descriptions of demister and wet scrubbing, respectively.

Achieved environmental benefits

- Prevention of fugitive releases of chemical fumes. [127, Continuous Coating Shadow Group 1999]
- Reduction in exhaust air volumes. [127, Continuous Coating Shadow Group 1999]
- Reduction of energy and water demand through lower evaporation and insulation.

Environmental performance and operational data

The control measures described above are employed for the reduction of emissions to air of volatile substances: substances capable of readily changing from a solid or liquid form to a vapour, having a high vapour pressure and a low boiling point (e.g. HCl). This includes volatile organic compounds as defined in Article 3(45) of Directive 2010/75/EU.

These measures are not necessary for the process baths if, for the post-treatment procedures, rolls, rinsing systems or dipping (soaking) baths are used instead of spraying systems and no volatile substances are used.

By using rolls, rinsing systems or dipping (soaking) baths and no volatile substances for the processes, there are no fugitive emissions because the formation of aerosols and vapours is not possible.

Cross-media effects

None.

Technical considerations relevant to applicability

- Not applicable when the storage temperature is low and when no volatile substances are used.
- Only applicable when the treatment is carried out by spraying or when volatile substances are used.

Economics

The investment and operating costs are medium. [[127, Continuous Coating Shadow Group 1999](#)]

Driving force for implementation

- Prevention and reduction of employee exposure to fugitive emissions of chemicals.
- Reduction of fugitive emissions to the environment.

Example plants

Voestalpine lines 2, 3, 4 and 5.

Plants from the data collection: 40 HDC, 41 HDC, 120 HDC, 132 HDC, 201 HDC.

Reference literature

[[31, EUROFER 10-7-18 2018](#)], [[127, Continuous Coating Shadow Group 1999](#)].

5.4.1.5.3 Closed tanks combined with air extraction in the case of continuous post-treatment

Description

Phosphating and passivation are carried out in closed tanks and the air is extracted from the tanks.

Technical description

Completely closed/sealed tanks where the material enters the phosphating or passivation tank through small openings are used in continuous processes.

See also Section 8.8.4.2.

Achieved environmental benefits

Reduction of emissions to air of volatile substances: substances capable of readily changing from a solid or liquid form to a vapour, having a high vapour pressure and a low boiling point

(e.g. HCl). This includes volatile organic compounds as defined in Article 3(45) of Directive 2010/75/EU.

Environmental performance and operational data information

No information provided.

Cross-media effects

No information provided.

Technical considerations relevant to applicability

Only applicable when the treatment is carried out by spraying or when volatile substances are used.

Economics

No information provided.

Driving force for implementation

Environmental legislation.

Example plants

Plants from the data collection: 96 HDC, 159 HDC, 223 HDC, 249 HDC.

Reference literature

No reference literature provided.

5.4.1.5.4 Minimisation of drag-out of chemical solution**Description**

The drag-out of chemical solution is minimised, e.g. by passing the strips through squeeze rolls or by allowing for sufficient dripping time for workpieces.

Technical description

The drag-out of chemical solution is minimised, e.g. by passing strips through squeeze rolls or by allowing for sufficient dripping time for workpieces. Metallic squeeze rolls (inox) may be used instead of rubber rolls. [\[24, TWG 2019 \]](#)

Achieved environmental benefits

Reduction of raw materials consumption. [\[127, Continuous Coating Shadow Group 1999 \]](#)

Environmental performance and operational data

No information provided.

Cross-media effects

None.

Technical considerations relevant to applicability

Generally applicable in plants using a passivation process. [\[127, Continuous Coating Shadow Group 1999 \]](#)

Economics

The initial investment is not high and the operating cost is low. [\[127, Continuous Coating Shadow Group 1999 \]](#)

Driving force for implementation

Material efficiency.

Example plants

Widely used.

Reference literature

[127, Continuous Coating Shadow Group 1999].

5.4.1.5.5 Use of roll coaters for strips

Description

Roll coaters are used to apply a passivation or a phosphate-containing layer on the surface of strips. This allows better control of the layer thickness and thus the reduction of the consumption of chemicals.

Technical description

Roll coaters are used to apply a thin passivation layer on galvanised steel strip. These passivation layers, e.g. of chromium, chromium-free or phosphate-containing medium, form a conversion layer which protects the underlying metal from corrosion. Phosphate-containing layers provide furthermore good sliding properties during cold forming.

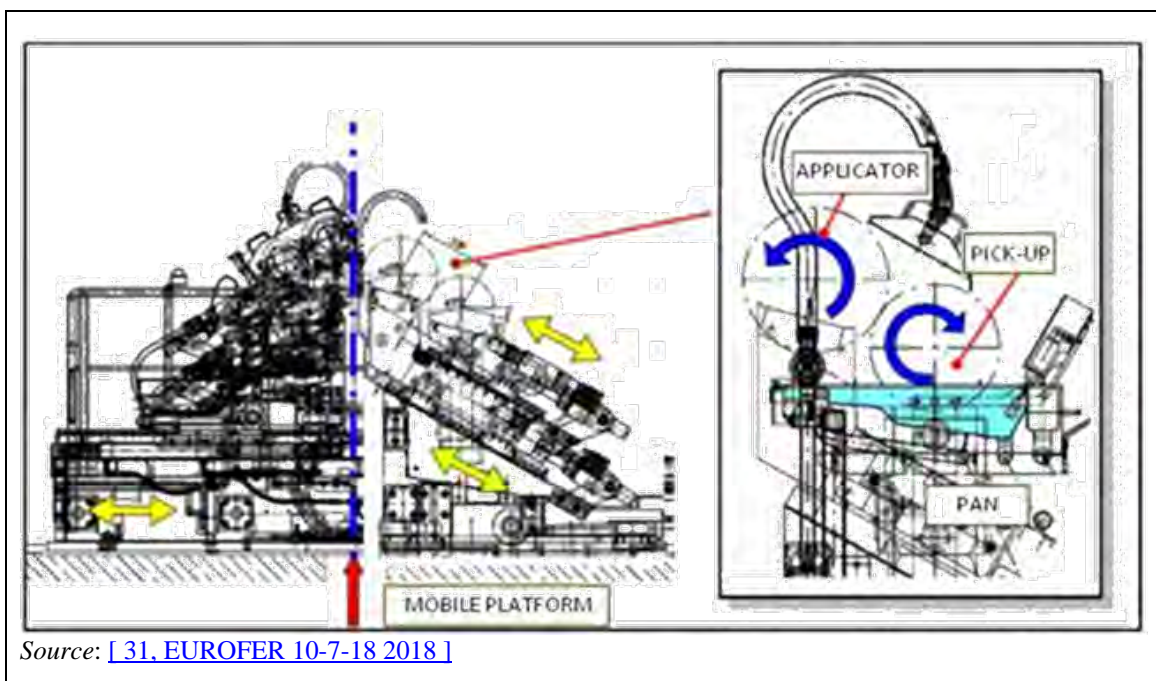
Especially thin organic coatings or chemical passivation solutions are applied by roll coaters. A roll coater enables to apply a precise metered amount of liquid chemical to both sides of strip although line speed varies in a big range.

The roll coater is located in hot dip galvanising lines as one of the last process steps, usually before an exit looper in order to prevent strongly fluctuating speeds during the coating.

In a galvanising line, the type of roll coater is normally a two-rolls coater which contains a pick-up roll and applicator roll. An individual coating head is used for the top side and bottom side. Both coating heads can be operated independently. The coater configuration can be horizontal or vertical. The application method can be forward or reverse, i.e. the applicator roll is rotated forward or against the strip movement.

A pick-up roll lifts liquid chemical from a coating pan. A pick-up roll is in contact with the applicator roll which sweeps the liquid from the pick-up roll and transfers it onto galvanised strip (see Figure 5.29).

The thickness of the layer is adjusted especially by the batch concentration and the mode of operation (rotating / contra-rotating operation and peripheral speed of the coating rolls). The main parameters in controlling the wet film thickness are the contact pressure between the pick-up and applicator roll and the roll speed. Normally the roll speed is controlled automatically and adjusted in relation to the strip speed. A uniform application is achieved by the adjustment of the filling level of the tub, the contact pressure of the scoop to the coating roll, as well as the setting force on the galvanised steel strip. After the coating process, the passivation layer is dried by a hot air dryer or similar (e. g. induction dryer, infrared dryer).



Source: [31, EUROFER 10-7-18 2018]

Figure 5.29: Roll coater

Achieved environmental benefits

More accurate passivation film thickness control reduces passivation chemical consumption. Especially with thick strip, heavy coating can be avoided at strip edges.

With the dip/spray squeeze method, it is necessary to use separate air nozzles at strip edges for thick material. This creates a lot of aerosol and dust which are safety risks. With a roll coater, this risk can be eliminated.

The amount of zinc dissolved into the passivation solution is estimated to be reduced by about 90 % compared to dip/squeeze or spray/squeeze methods. The need for cleaning the system and the amount of waste are decreased.

Environmental performance and operational data

The presetting of coating parameters can be made according to parameter tables. However, the final adjustments are made according to the measured film thickness of finished product. Therefore, a coating mass or thickness control is recommended.

A continuous wet film gauge can be placed after roll coaters. Normally passivation layer mass or thin organic coating film thickness is measured from coated samples. The coating mass is determined by the content of certain tracer elements in the chemical (Cr, Ti, P, Mn, etc.). Analysis is carried out with the XRF method or with a wet chemical method (AAS, ICP). TOC layer thickness can be measured by the beta backscatter method.

Regular cleaning of the roll coaters is necessary. Especially water-based acrylic easily sets on rolls. This causes quality problems and rejections of galvanised products. Cleaning procedures require extra manpower and waste water is created. However, the need for cleaning is related to chemical type used. In comparison to the traditional dip/spray squeeze method, the roll coater does not create significantly more waste water. In many cases, the waste water can be used to replenish new working solution.

The roll coating method is also commonly used in other types of production lines, e.g. in coil coating lines (similar equipment).

When acrylic resin is applied onto galvanised steel strip, a certain temperature is required for curing the coating. Depending on the galvanising line layout, the relatively high exit temperature (80–120 °C) might cause problems.

Roll coating is applicable for a wide range of liquid chemicals. Depending on the chemical, UV or IR curing can be used instead of hot air oven.

Cross-media effects

None.

Technical considerations relevant to applicability

The roll coating method is generally applicable to flat products.

Economics

The investment cost of a complete roll coating facility is around EUR 1.2 million. This contains two shuttle-type roll coaters, a working solution premixing and circulation system and a hot air oven for curing.

The operational costs excluding the chemical price are comparable to conventional spray bar squeeze roll systems. The total operational costs depend on application methods used: special engraved pick-up rolls are more expensive than polished rolls, reverse rotating applicator roll wear is faster, etc.

Driving force for implementation

Improved quality and versatility.

Example plants

- SSAB Hämeenlinna Site, hot dip galvanising line # 3, Finland.
- Thyssenkrupp Steel Europe AG, hot dip galvanising line no. 8.
- Liberty Piombino HDG 4.

Reference literature

[[135](#), [Dinter et al. 2006](#)].

5.4.1.5.6 Avoiding the use of hexavalent chromium compounds in passivation – use of other metal-containing solutions

Description

The use of chromium (VI) compounds in galvanising for passivation is not considered BAT due to environmental issues. Alternatively, other metal-containing solutions (e.g. containing manganese, zinc, titanium fluoride, phosphates and/or molybdates) are employed.

Technical description

Cr (VI) passivation is not considered BAT due to environmental issues.

Alternatively, other metal-containing solutions (e.g. containing manganese, zinc, titanium fluoride, phosphates and/or molybdates) are employed.

For example, Cr (III)-based passivations consists of types of Cr (III) fluorides.

The coating with chromium-free passivation has very little/fine structure and was proven to be completely amorphous with the aid of discontinuous X-ray fluorescence measurements. The protective properties of this coating formed by a conversion reaction are predominantly a function of a very effective barrier against corrosive ions and substances.

The corrosion protection of the chromium-free passivation coating as demonstrated in the saltwater spray test largely depends on the coating thickness. The coating thickness (an important quality criterion) is determined by the lead element, e.g. titanium, and by means of X-ray fluorescence analysis. If the coating thickness is too thin, corrosion protection will not be sufficient in the saltwater spray test. If the coating thickness is too thick, weldability and the metallic shine of the surface will be lost.

Cr (III) and Cr-free chemical passivation techniques are well established in several applications, but in continuous development. They are considered the state of the art for chemical passivation in Europe at the time of writing this document. In general, the choice of passivation solution depends on product specifications (e.g. surface quality, paintability, weldability, formability, corrosion resistance). For example, Cr-free solutions have disadvantages in terms of the formability and weldability of the final product but provides better paintability, in comparison with Cr (III) passivation solutions. [[40, EUROFER 31-3-17 2017](#)]

It should be noted that, at the time of writing the document, chromium III oxide is included in the Community rolling action plan (CoRAP) for substance evaluation under REACH. It is currently under evaluation for the following concerns: suspected reprotoxicity and suspected sensitizer.

Achieved environmental benefits

- Avoidance of Cr (VI) emissions to the environment.
- Avoidance of heavy metal, fluoride and waste emissions to the environment (that holds for the passivation solutions II and III – see Section 5.2.2.7).

Environmental performance and operational data

It is necessary to control the process parameters, e.g. conductivity, the concentration of titanium manganese or phosphate in the bath. The layer weight would be controlled by XRF methods or by wet chemical methods. With a mobile XRF device, the titanium or the phosphate layer weight (mg Ti/m²) is checked offline on the steel strip at the end of the hot dip galvanising plant. In wet chemical analysis, the layer thickness is measured indirectly from the chromium content of the stripping solution.

The amount of energy needed is the same as for the Cr (VI) passivation.

The amount of passivation solution needed is about 0.5–2.0 l/t Cr-free chemically passivated product.

Cross-media effects

Sometimes sediments build up in the passivation solution (Mn, Zn, Ti-phosphates or Cr(III) fluorides) which need to be disposed of.

Technical considerations relevant to applicability

Applicability may be restricted due to product specifications (e.g. surface quality, paintability, weldability, formability, corrosion resistance).

Chromium-free passivation is usually employed for the fabrication of final products necessitating good paintability rather than good weldability or formability. In contrast, chromium (III) passivation solutions are employed to obtain products with good weldability or formability rather than paintability.

Economics

No information provided.

Driving force for implementation

- Avoid the use of chromium (VI) for passivation.
- Employee safety and protection against workers' exposure to chromium (VI).

Example plants

Today, many hot dip galvanising plants have implemented the Cr(III)-based passivation technology (for example plants of Voestalpine Stahl GmbH); nevertheless, part of the production is done using the Cr-free passivation technology.

SSAB Europe Hämeenlinna Works HDG lines n°1 and n°3 in Finland use Cr (III) technology as well as AM HDC lines (for Example Aviles, Piombino).

Reference literature

[31, EUROFER 10-7-18 2018].

5.4.1.5.7 Avoiding the use of hexavalent chromium compounds in passivation – use of organic polymer solutions

Description

The use of chromium (VI) compounds in galvanising for passivation is not considered BAT due to environmental issues. Alternatively, organic polymer solutions (e.g. containing polyurethane or polyester) are employed. [40, EUROFER 31-3-17 2017]

Technical description

Thin Organic Coated (TOC) galvanised steel strips are produced in-line on a galvanising line. The solution is applied on the top and/or bottom side of a newly galvanised strip by a chem-coater (rollcoater), spray system, squeegee rolls and other coating techniques. The wet film is subsequently dried.

TOC is a film-forming coating based on polymers such as acrylic, epoxy, ethylene, polyurethane or polyester. The dry-film thickness is usually 0.5–3 µm. The coating can contain some corrosion inhibitors, for example compounds of titanium, trivalent chromium, vanadium or silicon. The coating not only enhances the corrosion resistance of galvanised strip but also acts as a dry lubricant and adds an anti-fingerprint feature to the strip, suitable for direct post-painting without further surface treatment. [31, EUROFER 10-7-18 2018]

Achieved environmental benefits

Cr(VI)-emissions are avoided by use of Cr(VI)-free chemical.

Environmental performance and operational data

Dry-film thickness can be measured offline using a beta backscattering measuring device. Titanium, phosphate, chromium or other trace elements in the coating can be measured using XRF.

Any excess fluoride-containing solution is properly disposed of in a waste treatment facility. The amount of energy can be higher than for the standard passivation due to the increased need for drying/curing the applied film (with IR or with a gas-operated dryer).

The expected wet film thickness is 1.5–6 g/m².

Compared to chemical passivation, TOC provides better resistance against so-called white rust of galvanised surface. It also helps in forming processes by acting as a dry lubricant. The anti-fingerprint feature is achieved.

Cross-media effects

Higher energy consumption due to the higher drying temperature and the necessary subsequent cooling.

Technical considerations relevant to applicability

- Applicability may be restricted due to product specifications (e.g. surface quality, paintability, weldability, formability, corrosion resistance).

Economics

High investment and medium operational costs.

Driving force for implementation

Avoid the use of chromium (VI) for passivation.

Example plants

SSAB Hämeenlinna Works, galvanising line n°3, Finland.

Liberty Piombino.

Voestalpine Stahl GmbH HDC line 2.

Reference literature

[31, EUROFER 10-7-18 2018], [42, Lantz et al. 2008].

5.4.1.6 Finishing**5.4.1.6.1 Collection and treatment of temper mill emulsion**

See Section 3.4.4.3.

5.4.1.7 Waste water treatment in galvanising line**Description**

Generally, the waste water treatment plants treat not only the water from coating plants but also all the effluents generated in the rolling facilities. Normally, these plants consist of three different circuits: chromic water line, oily water line and the general waste water line.

Alkaline cleaning is used in the galvanising lines to clean the oily residues and metallic particles from the surface of steel strip. Emulsions are used in the galvanising line temper mill. Passivation fume scrubbing causes very small amounts of dilute chromic-containing waters. All effluents from these treatments are treated in a galvanising line water treatment plant where oil, heavy metals (Zn, Cr), Fe, phosphates and other suspended solids are separated from the water. Techniques in use are oil separation, flotation, chromium reduction, neutralisation, flocculation, sedimentation, activated carbon filtration and ion exchange. [25, EUROFER 2018]

See Section 8.9 for more information about the techniques used.

5.4.2 Aluminising and lead-tin (terne) coating of sheets

Techniques to be considered in the determination of BAT are the same as for galvanising of sheets, when the same processing steps are applied (e.g. pickling, passivation, etc.)

5.4.3 Wire hot dip coating (galvanising)

5.4.3.1 Fluxing

5.4.3.1.1 Covered flux bath

Description

The flux bath is covered with a hood or bath cover to minimise heat losses.

Technical description

The flux bath is covered with a hood or bath cover. [[118, B. Gielen, Bekaert 1998](#)]

Achieved environmental benefits

Minimisation of heat losses, when the flux bath is heated. [[118, B. Gielen, Bekaert 1998](#)]

Environmental performance and operational data

No information provided.

Cross-media effects

No information provided.

Technical considerations relevant to applicability

Fluxing is not applied in hot dip coating of sheets. [[3, EUROFER 2020](#)]

Economics

No information provided.

Driving force for implementation

No information provided.

Example plants

Plant from the data collection: 204 HDC.

Reference literature

[[118, B. Gielen, Bekaert 1998](#)].

5.4.3.2 Hot dipping (galvanising of wire)

5.4.3.2.1 Zinc bath: good housekeeping

Description

Good housekeeping mainly involves maintaining a protective layer or a cover on the zinc bath to minimise zinc oxidation and heat loss and drying the wire before entering the zinc bath to avoid dust formation.

Technical description

The most important housekeeping methods are as follows:

- Maintain a protective layer (particulate material) or a cover on the zinc bath. This minimises loss of zinc by oxidation, the formation of flux fumes and drastically reduces energy losses of the zinc bath.
- Any moisture dragged into the zinc bath evaporates explosively. This cause of zinc dust can be eliminated by having a dry wire at the inlet of the zinc bath. [[118, B. Gielen, Bekaert 1998](#)]

Achieved environmental benefits

No information provided.

Environmental performance and operational data

By good housekeeping methods, it is possible to run a hot dip galvanising bath at very low emissions of Zn and dust (below 5 mg/Nm³ Zn, below 10 mg/Nm³ dust). [[118, B. Gielen, Bekaert 1998](#)]

Two wire coating plants took part to the FMP data collection for the revision of the FMP BREF, both applying good housekeeping. However, no information on dust emissions was reported.

Cross-media effects

No information provided.

Technical considerations relevant to applicability

No information provided.

Economics

No information provided.

Driving force for implementation

No information provided.

Example plants

Plants from the data collection: HDC 204, HDC 229.

Reference literature

[[118, B. Gielen, Bekaert 1998](#)].

5.4.3.2.2 Emission capture and treatment of extracted air**Description**

A hood or cover is installed over the zinc bath and combined with extraction of air and dust abatement by fabric filter.

Technical description

When, for one reason or another, good housekeeping is not sufficient to reach low Zn and dust emissions, a hood or cover above the Zn bath, extraction of air and a filter can be installed. [[118, B. Gielen, Bekaert 1998](#)]

Achieved environmental benefits

Reduced emissions of dust and zinc to air from hot dipping.

Environmental performance and operational data

One plant that took part in the data collection reported the application of this technique, but no information on dust emissions was submitted.

Cross-media effects

No information provided.

Technical considerations relevant to applicability

No information provided.

Economics

No information provided.

Driving force for implementation

No information provided.

Example plants

Plants from the data collection: HDC 204, HDC 229.

Reference literature

[118, B. Gielen, Bekaert 1998].

5.4.3.2.3 Air or nitrogen wiping

Description

After leaving the molten zinc bath, circular air or gas jets around the wire blow the surplus coating metal off the wire surface back into the galvanising kettle.

Technical description

No information provided.

Achieved environmental benefits

No information provided.

Environmental performance and operational data

No information provided.

Cross-media effects

No information provided.

Technical considerations relevant to applicability

Generally applicable to wire coating.

Economics

No information provided.

Driving force for implementation

No information provided.

Example plants

No information provided.

Reference literature

No reference literature provided.

5.4.3.2.4 Mechanical wiping

Description

After leaving the molten zinc bath, the wire is passed through wiping equipment/material (e.g. pads, nozzles, rings, charcoal granulate) which take the surplus coating metal off the wire surface back into the galvanising kettle.

Technical description

No information provided.

Achieved environmental benefits

No information provided.

Environmental performance and operational data

No information provided.

Technical considerations relevant to applicability

Generally applicable to wire coating.

Economics

No information provided.

Driving force for implementation

No information provided.

Example plants

No information provided.

Reference literature

No reference literature provided.

5.5 Emerging techniques for continuous hot dip coating

5.5.1 Jet vapour deposition

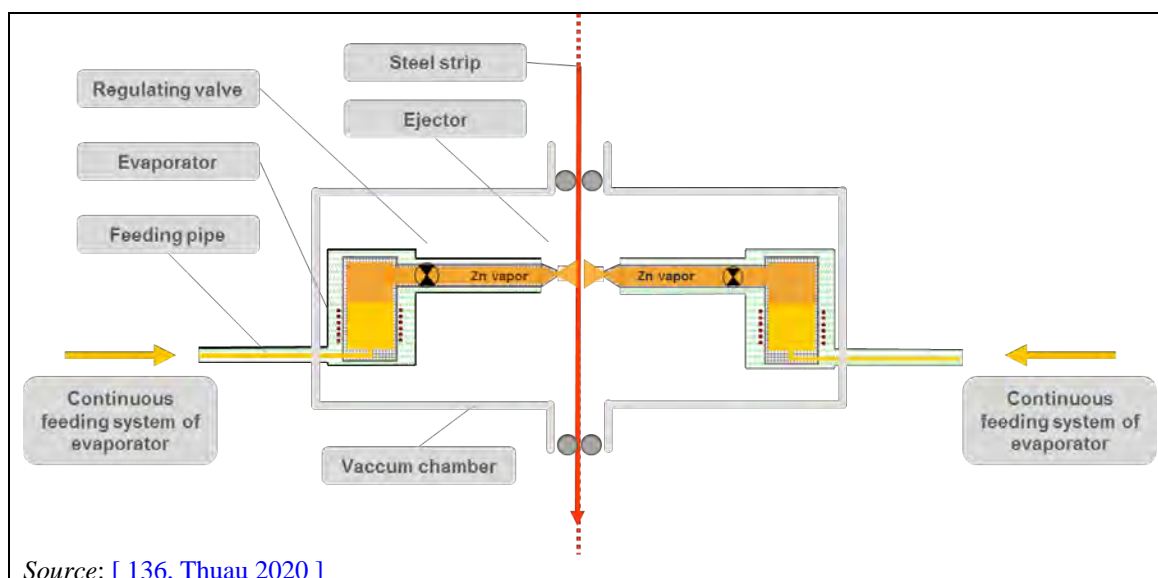
Description

Coating of a moving strip of steel inside a vacuum chamber by vaporisation of zinc onto the steel at high speed.

Technical description

The conventional industrial processes for coating steel sheets with zinc are the hot dip and electro galvanising processes. Jet vapour deposition (JVD) is a new coating process where coating is carried out by thermal evaporation of zinc under vacuum. JVD is a new technique under continuous development which, at the time of writing this document, is not able to replace totally more conventional coating processes.

After degreasing and annealing, the steel strip is transported towards the zinc coating area of the jet vapour deposition installation. The lock at the entrance of the vacuum zone enables the steel strip to enter into an atmosphere under vacuum. After being slightly reheated, the strip is transported towards the zinc coating area of the JVD installation, where the zinc is vaporised onto the strip using a movable blower. The zinc condenses on the cold strip and solidifies. The coated strip then passes through an exit lock (similar to the entrance lock), bringing it back to normal atmospheric pressure. Figure 5.30 provides a schematic diagram of a JVD coating installation.



Source: [136, Thuau 2020]

Figure 5.30: Schematic diagram of a jet vapour deposition unit for coating a moving strip of steel with zinc

Achieved environmental benefits

A life-cycle assessment evaluating the environmental impact of the JVD process as a whole including the coating, the use phase of the products, the waste products and their management showed a higher yield and lower energy consumption than other coating techniques. [136, Thuau 2020]

Environmental performance and operational data

At ArcelorMittal Kessales, pure zinc (99.9 %) is delivered in ingots. It is heated up to 420 °C (zinc melting point) and aspirated towards an evaporator. The zinc melting furnace capacity is 40 tons. The steel strip is moving through the line at a maximum speed of 180 m/min.

There are multiple advantages to this new technology, including:

- exceptionally even coating of the steel sheet;
- excellent adhesion of the coating, independently of the steel grade, and avoiding ultra-high-strength steel from becoming more brittle under the influence of hydrogen;
- working in a vacuum enables lower evaporation temperatures, and also creates a 'pure' environment which removes the risk of zinc and steel oxidising;
- highly flexible process thanks to its ability to produce different coating thicknesses (one side versus another) and to coat a variety of substrates regardless of their chemical composition.
- very high zinc yield, mostly eliminating gross losses.

Cross-media effects

None reported.

Technical considerations relevant to applicability

No information provided.

Economics

The reported cost for the installation of a brand new JVD production line at ArcelorMittal Kessales is > EUR 60 million. [[137, ArcelorMittal Kessales 2017](#)]

Driving force for implementation

- Savings in energy and zinc yield.
- Increased effectiveness of the zinc coating operations.

Example plants

ArcelorMittal Kessales (Belgium).

Reference literature

[[136, Thuau 2020](#)], [[137, ArcelorMittal Kessales 2017](#)].

6 BATCH GALVANISING

6.1 General information on batch galvanising

General galvanising is a service industry, offering the application of zinc coating corrosion protection to steel fabricators or the users of fabricated steel products. The sector operates with short lead times and short order books to provide an enhanced service to customers. Distribution issues are important and so plants are located close to market concentrations. Consequently, the industry consists of a relatively large number of plants servicing regional markets in order to minimise distribution costs and increase economic efficiency. Only a few niche operators are prepared to transport certain classes of fabricated products over longer distances in order to exploit their special expertise or plant capability. Opportunities for these specialist operators are limited.

Table 6.1 provides information on the production output of 641 batch galvanising plants in Europe that are distributed in 22 countries and the United Kingdom. In addition to the plants listed in Table 6.1, there are also additional batch galvanising plants in Cyprus, Croatia, Estonia, Latvia, Lithuania, Luxembourg, Malta and Slovenia for which no data were provided during the information exchange.

Table 6.1: Distribution of batch galvanising plants in Europe and production output

Country	Number of plants in 2019	Steel galvanised in 2019 [t/yr]
Austria	19	285 000
Belgium	15	222 643
Bulgaria	8	40 000
Czech Republic	26	185 161
Denmark	11	102 021
Finland	13	52 112
France	53	529 140
Germany	148	1 944 115
Greece	9	44 500
Hungary	11	129 897
Iceland	2	750
Ireland	6	58 098
Italy	65	1 011 429
Netherlands	14	294 162
Norway	12	51 135
Poland	63	790 000
Portugal	8	95 000
Romania	12	99 100
Slovakia	11	46 515
Spain	43	648 450
Sweden	29	92 269
Switzerland	11	80 000
United Kingdom	52	636 322
Total	641	7 427 819
<i>Source:</i> [138, EGGA 2019]		

In 2019, the zinc consumption for the batch galvanising plants listed in in Table 6.1 was 430 405 tonnes. The main galvanising countries were Germany with 26.1 % of the production, Italy with 13.6 %, Poland with 10.6 %, the United Kingdom with 8.5 % and France with 7.1 %.

The share of the total market accounted for by various market sectors is shown in Table 6.2.

Table 6.2: Market segmentation for galvanised steel in 2019

Market	Tonnage (t) ⁽¹⁾	Percentage (%)
Building and construction	2 975 158	44.8
Street furniture	860 497	13.0
Utilities	584 831	8.8
Agriculture/horticulture	692 057	10.4
Transport	484 661	7.3
Fasteners	193 958	2.9
Industrial equipment	540 608	8.1
Other	311 849	4.7
Total	6 643 619	100

(¹) The figures reported represent the total production for the European countries listed in Table 6.1 that reported market segmentation data to EGGA. In this case, Poland did not report market segmentation data. The segmentation is considered representative of all Europe.
Source: [138, EGGA 2019]

The capacities of the most economic operating units are related to the size of the steel fabrications to be treated and to the demand in the accessible market. Most companies in the sector are small or medium-sized enterprises financed by private capital. Integration in the zinc production or steel fabrication industry is very unlikely. About half of the European capacity is in the hands of businesses that own one or two plants. However, larger companies also exist that own multiple plants in one Member State or across several Member States. Even so, the assets of these groups are widely distributed in order to service regional markets and the opportunity for concentration of productive capacity is limited. [139, EGGA - a 1998]

In general, the sector enjoys reasonable economic success but it is occasionally subject to price pressures because of over-capacities in some markets and variations in the price of zinc.

6.2 Applied processes and techniques in batch galvanising

6.2.1 Batch hot dip coating overview

Hot dip galvanising is a corrosion protection process in which iron and steel fabrications are protected from corrosion by coating them with zinc. Prevalent in batch hot dip galvanising is job galvanising - also referred to as general galvanising - in which a great variety of input materials are treated for different customers. The size, amount and nature of the inputs can differ significantly. The galvanising of pipes or tubes, which is carried out in semi- or fully automatic special galvanising plants, is not usually covered by the term job galvanising.

The items to be coated in batch galvanising plants are steel fabrications, such as nails, screws and other very small items; lattice grates; construction parts; structural components; light poles; and many more. Tubes are sometimes also galvanised in conventional batch coating plants. Galvanised steel is used in construction, transport, agriculture, power transmission and everywhere that good corrosion protection and long lifetime are essential. [139, EGGA - a 1998]

Figure 6.1 shows the sequence of operations in a batch galvanising plant, which usually comprises the following process steps:

- degreasing;
- pickling;
- fluxing;
- galvanising (melt metal coating);
- finishing.

A galvanising plant essentially consists of a series of treatment or process baths. The steel is moved between tanks and dipped into the baths by overhead cranes.

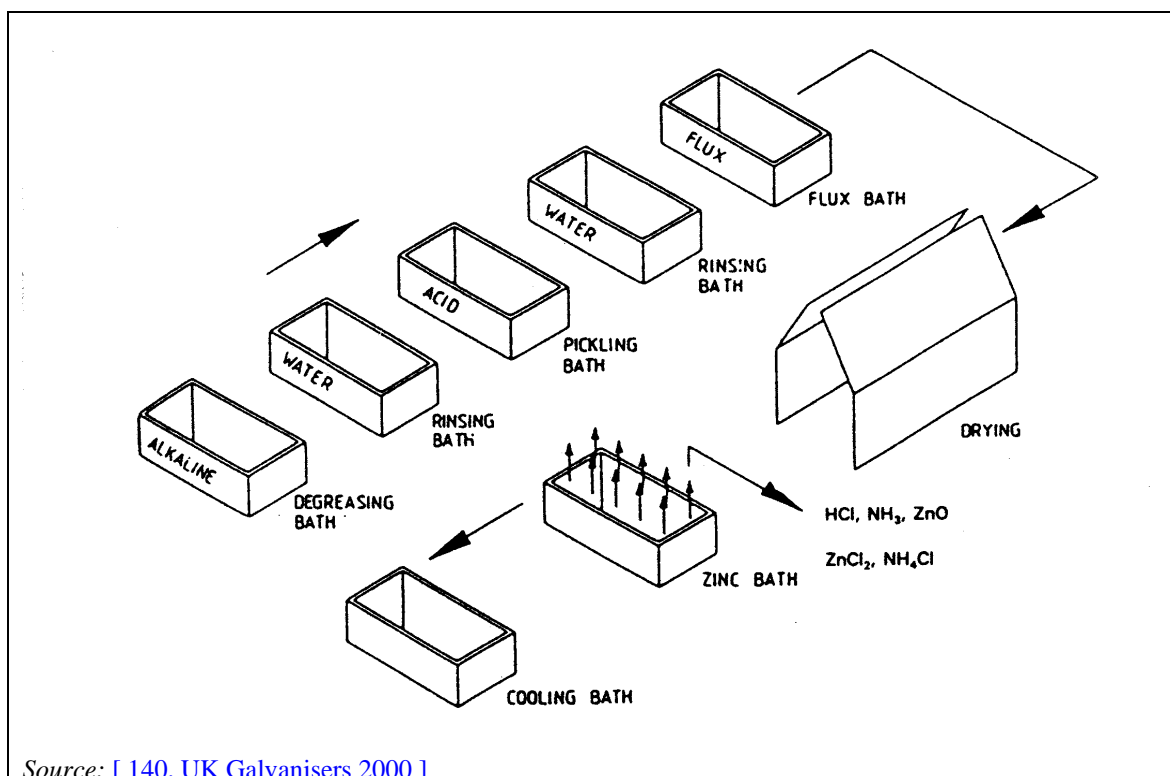


Figure 6.1: Typical process flow for a general galvanising plant

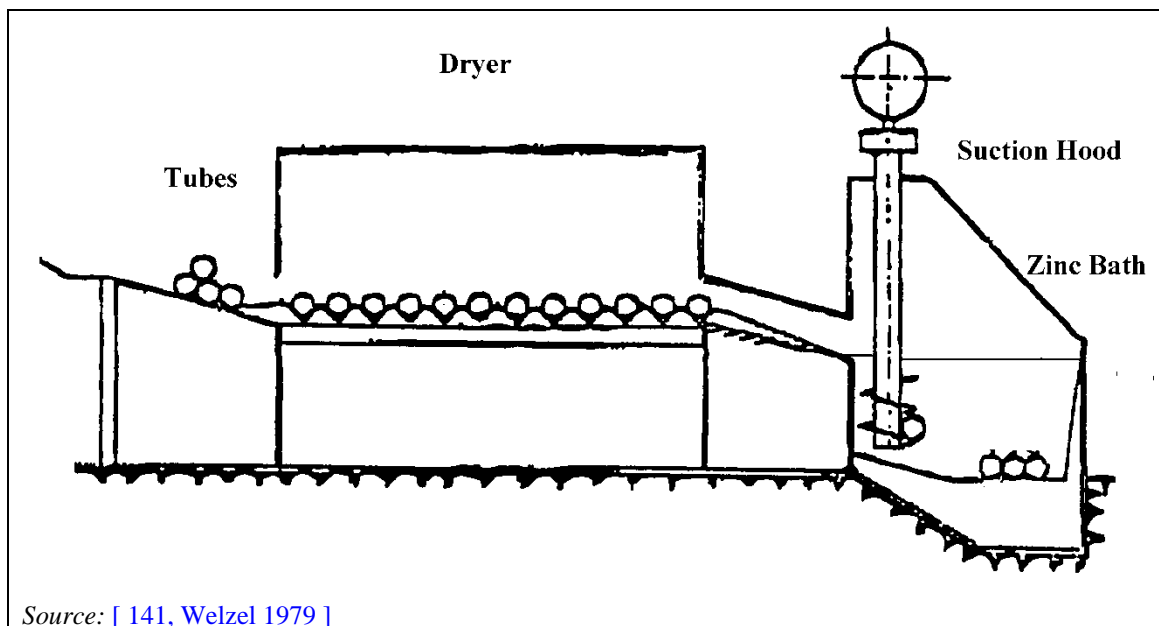
There are two basic plant layouts, distinguished by the design of the pretreatment section: open or closed pretreatment.

Galvanising plants with open pretreatment locate pretreatment vats and the other process operations in one bay. In these cases, pickling baths are either operated within a restricted range of acid temperatures and HCl concentrations (refer to Section 6.4.2.6) or equipped with an emission capture, extraction and abatement system (refer to Sections 8.8.4.1 and 8.8.4.2) in order to limit emissions to air (acid fume) and the associated corrosion of installations.

Galvanising plants with dedicated, tightly enclosed pretreatment sections and equipped with fume extraction and abatement (refer to Section 6.4.2.8) may operate pickling baths at elevated temperatures and thus reduce the number of pickling vats and the pickling time.

For some special applications, the galvanising bath can be operated at elevated temperature using ceramic-lined kettles instead of steel kettles; this process variation is referred to as 'high-temperature galvanising'.

Installations for tube galvanising represent a special type of galvanising plant in which tubes are quasi-continuously coated. The handling of tubes in these plants is partly or fully automated. Figure 6.2 shows the dipping principle of such plants.



Source: [141, Welzel 1979]

Figure 6.2: Principle of tube galvanising

The principal pretreatment steps are the same as for general galvanising but, following the coating, the excess zinc is removed from the outside of the tubes by blowing with compressed air. The excess zinc on the inside is removed by a water/steam pressure pulse.

Although the basic technological principles have remained unchanged over the past 150 years, some developments have taken place mainly to improve the coating quality of reactive steels or small parts. Research has been done on adding vanadium and titanium to the molten zinc bath and on developing a zinc-tin coating. The addition of approximately 0.03 % to 0.08 % nickel to the zinc bath (Technigalva process) has been applied for some time now at full industrial scale. Aluminum is particularly beneficial in zinc coatings and has resulted in development of various coatings with Al content between 5% and 55% with increased corrosion performance in many applications. Zinkopal (Zn-5% Al), in which a zinc-aluminium coating for small parts is used,

was developed in Germany, where one plant is in operation. [142, Hageböling, V. 1997], [143, EGGA 1999]

6.2.2 Raw material handling

Zinc is received in bulk form and stored close to the galvanising process. Chemicals, principally 28 % HCl, an input to the pickling process, are received in plastic or glass containers or by road tanker, and are stored according to manufacturers' instructions. Other agents, such as mist suppressants and degreasing fluids, are similarly received in drums and stored according to manufacturers' instructions. Materials for processing, consisting of a wide variety of steel fabrications, are received on site, usually by road haulage, and are unloaded by forklift truck or crane. [139, EGGA - a 1998]

6.2.3 Preparation of the input

Steel fabrications are inspected to ensure that they are suitable for galvanising. Iron and steel castings and some threaded components are abrasive blast cleaned before pickling. To handle fabrications throughout the galvanising process, they are attached to jigs or strongbacks by means of hooks or steel wire. Fasteners and other small components are loaded into perforated baskets, which are attached to the jigs. [139, EGGA - a 1998]

6.2.4 Degreasing

To guarantee satisfactory galvanising and to enhance the performance of filtering separators, a degreasing step is used to remove traces of coolants and lubricants from the fabricated steel. This is commonly done using alkaline degreasing baths. These baths contain surfactants, which remove oil and grease from the metal surface by emulsifying. The resulting unstable emulsions float on the surface of the bath and can be removed by gravitational separators, skimmers, micro- or ultrafiltration, etc.

The concentration, bath temperature and immersion time of the workpieces determine the efficiency of the degreasing baths. The normal temperature range for indirectly heated degreasing baths is 30–70 °C, although in some cases hot degreasing is applied at a temperature of about 85 °C. The bath consists of a sodium hydroxide solution (1–10 %) plus other alkaline reagents, such as soda, sodium silicate, condensed alkaline phosphates and borax as well as specific surfactants, emulsifying agents and dispersion agents.

An alternative method is acidic degreasing. Degreasing baths consist of diluted strong inorganic acids, like hydrochloric acid and/or phosphoric acid with additives. Acidic degreasing agents usually form stable oil emulsions which obstruct bath maintenance measures such as skimming, separating, centrifuging or ultrafiltration. [144, ABAG 1993]

When degreasing is skipped or when insufficiently degreased workpieces enter the process flow, there is a risk of organic pollutants being carried over to subsequent process steps, possibly leading to organic pollution in the flux fume arising from the galvanising kettle during dipping. Organic pollutants in the waste gas lead to operational problems with filtering precipitators (clogging, etc.) and make the recycling of precipitated dusts difficult or even impossible. [139, EGGA - a 1998], [144, ABAG 1993]

Degreasing may only be omitted if the input material is oil-free, which is the exception rather than the rule in batch galvanising.

After degreasing, rinsing is necessary to prevent carry-over of degreasing agents which would shorten the lifetime of pickling baths and reduce the reusability of the bath.

6.2.5 Pickling

6.2.5.1 HCl pickling

To remove casting skin, roll skin, grit or scale, the items are pickled in diluted hydrochloric acid. Therefore, a galvanising plant usually comprises a series of pickling baths with different acid concentrations ranging from 2 % to 16 %, normally 12 % to 16 % when freshly prepared. To prevent excessive pickling of steel items, especially when pickling high-tensile steels, and to protect the steel pickling vats, pickling inhibitors (e.g. hexamethylenetetramine) are added to the bath. [\[139, EGGA - a 1998 \]](#), [\[144, ABAG 1993 \]](#), [\[143, EGGA 1999 \]](#)

During operation the iron content of the pickling bath increases, conversely the amount of free acid decreases, making it necessary to top up the bath occasionally by adding fresh acid. Iron(II) chloride has a limited solubility in HCl. When the maximum is reached, pickling becomes impossible, but usually the pickling bath has to be replaced even sooner at lower FeCl₂ concentrations. Discarding concentrations of 170 g FeCl₂/l (= 75 g Fe²⁺/l) and 100–120 g Fe/l have been reported. [\[139, EGGA - a 1998 \]](#), [\[143, EGGA 1999 \]](#), [\[144, ABAG 1993 \]](#), [\[145, DK, TWG member 1999 \]](#)

Raising the temperature of the pickling bath can enable its use at relatively high concentrations of FeCl₂, e.g. 175–200 g/l with the bath at 35 °C, with some increase in emissions. [\[146, EGGA 2000 \]](#)

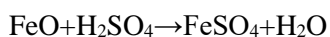
Operators sometimes degrease articles with less heavy deposits of oil in the pickling tank. This practice may lead to an increased pickling time, greater volumes in discarded pickling bath per tonne of product and increased consumption of zinc. This practice cannot be considered environmentally friendly.

Pickling in plants with open pretreatment is usually done at ambient air temperature while plants with an enclosed pretreatment often operate with higher acid temperatures. Gaseous emissions of the pickling agent can arise from the pickling baths, depending on the concentration and temperature of the bath, and from the pickled items. Hydrogen vesicles formed during the pickling process can also contain acid droplets. [\[139, EGGA - a 1998 \]](#), [\[147, VDI 2008 \]](#)

6.2.5.2 H₂SO₄ pickling

The vast majority of batch galvanising plants use HCl for pickling. Pickling by sulphuric acid solution was reported to be more common for galvanised tube production. The pickling process is basically the same as for HCl pickling.

Cleaning of the steel items' (tubes) surface prior to hot-dip galvanising is performed by pickling after degreasing. Steel tubes are placed into pickling tanks containing a dilute sulphuric acid solution (20 % H₂SO₄, 80 % H₂O) heated to 60 °C. During this step, the surface of the steel tubes is cleaned of iron oxide through the chemical reaction:



Inhibitors are used to limit and ideally prevent the following reaction $\text{Fe} + \text{H}_2\text{SO}_4 \rightarrow \text{Fe}_2\text{SO}_4 + \text{H}_2$ affecting the iron surface corrosion.

The activity and rate of pickling are kept constant by means of a continuous process in which a control system keeps the set of the operating conditions steady (temperature and concentration of the acid solution) through continuous feeding of fresh pickling solution. [\[148, IT 18-4-17 2017 \]](#), [\[160, BG Q 198 2018 \]](#)

6.2.6 Stripping

Sometimes it is necessary to clean the suspension devices of zinc coatings, to remove faulty coatings from steel fabrications or to de-zinc fabrications that are to be regalvanised at the end of their useful service life. This is commonly done by dipping in diluted pickling acid. Recently, regalvanising has become more widespread. Regalvanising includes the processing of pre-used galvanised articles (e.g. highway guard rails) that are returned to be regalvanised after long periods of service. Processing of these articles differ from standard processing due to the presence of partly corroded surfaces or the need for removal of any residual zinc coating.

When pickling and stripping are carried out in the same treatment vat, pickle liquors are created which contain iron chloride and zinc chloride. Some galvanisers operate separate pickling and stripping baths because, in their technical and economic environment, this favours recycling of the zinc contained in them. Spent stripping liquor can be either treated on site for zinc recovery or sent off site to a contractor for zinc recovery.

In some cases, spent stripping liquor is sent for neutralisation and disposal by external contractors. [\[149, Wedge Group 2000 \]](#)

6.2.7 Rinsing

Rinsing is a very important step in the galvanising process as it prolongs the lifetime of subsequent treatment baths, reduces the generation of waste and increases the reusability of by-products. After degreasing and pickling, the fabricated steel is therefore rinsed/dipped in water baths, which are sometimes heated.

Carry-over of solution between baths depends on the type of workpiece (i.e. its capacity for fluid retention) and the way in which it is handled, especially the drainage time permitted above a bath before the workpiece is moved. The quantity of liquid carried over can vary between 5 l/t and 20 l/t of black steel. Carry-over of degreasing solution into the pickling baths eventually leads to neutralisation of the bath; carry-over of acids and iron salts from pickling into the flux baths and further to the galvanising pot would increase both the generation of hard zinc (dross) and the consumption of zinc. A carry-over of 1 g of iron results in about 25 g of hard zinc. [\[143, EGGA 1999 \]](#), [\[144, ABAG 1993 \]](#), [\[146, EGGA 2000 \]](#)

Water from rinsing can be used to prepare fresh pickling or degreasing baths as a way of recycling water and minimising aqueous blowdown.

6.2.8 Fluxing

The purpose of fluxing is to enable liquid zinc to wet the surface of the steel, a necessary prerequisite for the galvanising reaction, and, with ammonium-chloride-containing fluxes, to provide additional pickling (cleaning of the surface) during hot dipping. At temperatures of above 200 °C the ammonium chloride in the flux decomposes into NH_3 and HCl , which results in an additional pickling effect. [\[139, EGGA - a 1998 \]](#), [\[144, ABAG 1993 \]](#)

Fluxing is carried out in two different ways: dry and wet.

In **dry fluxing**, the steel is immersed in a fluxing bath, usually an aqueous solution of zinc chloride and ammonium chloride, typically maintained at 40–80 °C. Cold fluxing is possible but reduces the potential for air drying of the work after removal from the flux bath. Typical bath characteristics are:

- ZnCl_2 : 150–300 g/l;
- NH_4Cl : 150–300 g/l;

- density: 1.15–1.30 g/ml;
- dissolved iron: < 2 g/l.

The pH value of flux baths is normally adjusted to approximately 4.5 to secure precipitation of iron ions as iron(III) hydroxide, but the pH of flux baths may be in the range of 1 to 5.0.

The total concentration of flux salt (sum of zinc chloride and ammonium chloride) and the ratio of the zinc chloride to ammonium chloride are both very important. Ammonium chloride in a typical good flux often accounts for 40–60 % of the total flux salt. [\[145, DK, TWG member 1999 \]](#)

Ammonium chloride provides quick drying and better removal of iron oxides from the surfaces of the items, but also causes more fume, ash and dross formation during the coating process. When the pretreatment of the workpieces is insufficient, more ammonium chloride is required. Zinc chloride prevents oxidation of the workpiece surfaces. This is particularly important when the drying time is long. Altogether, the optimum flux concentration and composition must be adjusted to the particular circumstances. [\[145, DK, TWG member 1999 \]](#)

The iron content of the flux bath is extremely important for process control, economy and the environment. A high concentration of iron in the flux (originating from drag-out from the pickling bath) will also influence the quality of the zinc coating. Iron carry-over from the flux bath to the zinc kettle will generate dross and may also increase the final thickness of the zinc layer for many steel grades. [\[145, DK, TWG member 1999 \]](#)

To reduce the environmental impact of ammonium chloride during dipping, some galvanisers are using ‘smoke-reducing’ fluxing agents in which ammonium chloride has partly or completely been substituted by potassium chloride. [\[144, ABAG 1993 \]](#)

After withdrawing the workpieces from the flux bath, some of the water from the adhering fluxing fluid evaporates. The extent of evaporation depends on the temperature of the flux bath and, if the bath is hot, the rate of removal of workpieces from the bath (slower removal gives more evaporation). Further drying is sometimes achieved in dedicated drying. Exhaust gases from the galvanising kettle can sometimes be a useful indirect source of heat to such a drying unit, although ancillary burners are often also used. Drying of the workpiece helps reduce splashing and ejection of metal from the zinc bath as the workpiece is dipped, a benefit which is increased if the workpiece retains heat after leaving the dryer, i.e. if preheating is applied. [\[146, EGGA 2000 \]](#)

A small number of galvanising works, especially those with exceptionally demanding fluxing requirements for intricate parts, operate an alternative process, called **wet fluxing**. In this process, the fluxing agents flow as a layer of molten salt on the surface of the galvanising bath. Steel parts to be galvanised are passed through the flux layer into the zinc bath. Then the molten salt layer is drawn back from the surface by means of a rake to allow the steel parts to be withdrawn from the galvanising bath without further contact with the flux. [\[139, EGGA - a 1998 \]](#)

6.2.9 Hot dipping

The fluxed steel fabrications are slowly lowered into a bath of molten zinc. With very long items, which do not fit in the kettle, double dipping has to be applied to cover the whole surface. The steel reacts with the zinc to form a coating consisting of a series of zinc-iron alloy layers topped by a layer of pure zinc when the parts are withdrawn from the bath. The period of immersion varies from several minutes for relatively light steelwork up to 30 minutes for the heaviest structural parts. [\[139, EGGA - a 1998 \]](#)

The molten zinc has a temperature of 440–475 °C. Kettle dimensions vary greatly, depending on the market served and the type of fabricated product treated. Typical dimensions are 7 m long by 1.4 m wide by 2.6 m deep, but kettles as long as 20 m and as deep as 4 m are in use. The kettle, enclosed by the furnace casing, is installed in a pit or at floor level with access platforms. The kettle is normally heated externally, commonly by gas or oil-fired burners. Heating by immersion burners or by canopy heaters is used when the zinc temperature is above about 460 °C (and a steel kettle cannot be used) or where there is insufficient kettle wall surface to transfer heat into the melt. Where economically viable, electrical heating is used, usually via radiation from the sides or top, occasionally also by induction or resistance. [\[103, FI, TWG member 2000 \]](#), [\[139, EGGA - a 1998 \]](#), [\[146, EGGA 2000 \]](#)

The galvanising bath contains mainly special high grade zinc but may also contain very small quantities of other metals which are either trace elements of the zinc input; elements that arise as a result of reactions between molten zinc and the steel articles; or are added as alloying elements (e.g. nickel, aluminium or bismuth) that have function in either the process or the coating. The choice and level of alloying elements for each plant is determined by the galvaniser and will vary according to typical work mix and other parameters. Recycled (remelt) zinc may also be added to the galvanising bath and may contain other impurities that are reflected in the bath composition. The thickness of the kettle walls is measured on a regular basis to monitor wear and avoid breakouts of molten metal. [\[32, Pre-FD comments 2021 \]](#)

Where steel kettles are used, it is important that the kettle material (typically low-carbon steel with minimal additions of reactive elements such as silicon) is correctly chosen so as to reduce the effect of zinc attack, and that it is manufactured to withstand the high hydrostatic loads and thermal stresses generated during the heating up to operating temperature. Steel kettles internally clad to resist zinc attack can be obtained but are significantly more expensive. [\[146, EGGA 2000 \]](#)

A small number of plants carry out ‘high-temperature galvanising’ using refractory-lined vessels, which allow the zinc bath to be operated at higher temperatures, usually about 530 °C. This process is required to treat certain classes of steel (steel grades) and specific types of components. [\[139, EGGA - a 1998 \]](#)

Ammonium chloride, a component of the fluxing agent, has a sublimation temperature below the zinc bath temperature, and this, together with the other reactions taking place, causes fumes to be generated during hot dipping. Galvanising kettles are generally contained in a vented enclosure or ventilated by a lip extraction system. Commonly, the ventilation air is cleaned in bag filters and the precipitated dust is shipped off site for recovery of valuable substances, namely fluxing agent. In some cases, the precipitated dust is sent for landfill. [\[149, Wedge Group 2000 \]](#) Some operators apply venturi scrubbers and use the scrubber blowdown for flux solution make-up. [\[139, EGGA - a 1998 \]](#), [\[146, EGGA 2000 \]](#)

Reactions of zinc with steel, either from the fabricated products that are being galvanised or from the kettle itself, lead to a build-up of zinc-iron alloy in the bath, which is known as hard zinc or dross. Dross can adhere to the walls of the bath, but mostly accumulates at the bottom where it is periodically removed using a submerged scoop or grab. Excess dross may interfere with galvanising and may cause overheating of an externally heated kettle. The material removed is returned to the secondary zinc industry for recovery of the zinc content or to the zinc chemicals industry for the manufacture of zinc oxide. [\[139, EGGA - a 1998 \]](#), [\[143, EGGA 1999 \]](#), [\[146, EGGA 2000 \]](#)

Zinc ash is formed at the surface of the zinc bath due to the reaction of zinc with oxygen in the air and with the flux. The oxidised material is removed and is reused directly in the plant or returned to the secondary zinc industry for recovery. [\[103, FI, TWG member 2000 \]](#), [\[139, EGGA - a 1998 \]](#)

6.2.10 Finishing and post-treatment

Steel fabricated products are withdrawn from the zinc bath; excessive zinc is removed by wiping or, in some cases, by rattling. The fabricated products are then cooled and inspected. Small surface imperfections are repaired and the fabricated products are removed from the jigs and made ready for dispatch. After hot dip coating, some steel products are quenched in water to give them special properties. As protection against white rust, the products may be covered with oil emulsions or undergo passivation.

Out of 99 lines (87 plants), 71 lines were reported not to apply any passivation. Only 12 lines were using Cr (VI) passivation, while the remaining 16 lines apply alternative (Cr-free) passivation, such as Cr³⁺ passivation or organic passivation. [\[16, FMP TWG 2018 \]](#)

In galvanising fasteners and small components, a perforated steel basket containing the components is immersed in liquid zinc in the usual way. When the basket is withdrawn from the liquid zinc it is placed into a centrifuge system. Excess zinc coating is removed by centrifugal force. The galvanised components are ejected from the basket and cooled, while the basket is returned to the process. Proprietary and custom-built systems are known. [\[146, EGGA 2000 \]](#)

When galvanising tubes and pipes, the outside is blown off with compressed air, and the inside with steam to remove excess zinc after withdrawal from the zinc bath. During removal of excess zinc with steam, zinc dust is emitted, but the zinc particles can be collected and returned to the zinc baths or be utilised in the secondary zinc industry for zinc recovery. [\[139, EGGA - a 1998 \]](#)

6.3 Current consumption and emission levels for batch galvanising

6.3.1 Batch galvanising mass stream overview

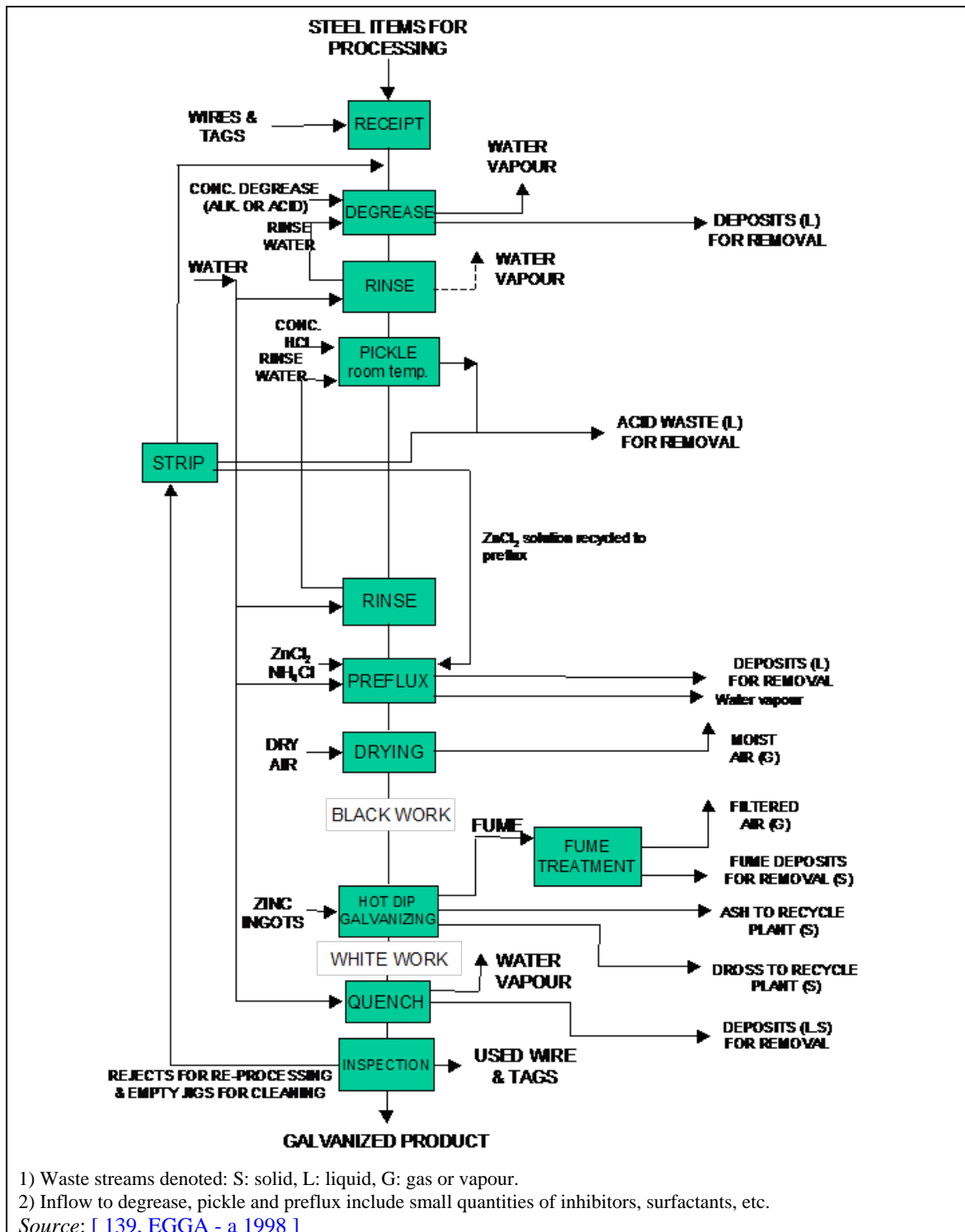


Figure 6.3: Material flow sheet for general galvanising plants

Many different factors influence the consumption of resources and the emission of pollutants and wastes for general galvanising plants. Variations between plants are caused by: variations in the nature of the steel inputs such as size, shape and most of all, cleanliness; the type of kettle

used; the heating devices; the process flow and the degree of regeneration and reuse of materials in the process.

Environmental impacts to be expected from general galvanising are emissions to air and the generation of waste, in most cases classified as hazardous. Waste water and emissions to water are not a major environmental issue, as it is possible to run general galvanising plants almost waste water free. [\[150, Danish EPA 1993\]](#)

Although waste water discharge is only a minor issue, zinc in surface water run off might have to be considered.

Sources of emissions to air are: the pre-treatment section, mainly from pickling operations; the molten zinc surface, especially during the dipping process, and the firing/combustion systems for heating of the zinc kettle or other treatment vats.

Wastes and by-products arising from batch galvanising are zinc-containing dross and ash as well as spent treatment liquors and sludges from the maintenance of the baths. [\[150, Danish EPA 1993\]](#) During transportation of the fabrications from one treatment bath to the other, fluids (acid, flux etc.) may drop from the work-pieces. This spillage is usually caught by drip pans and can either be recycled or collected as chemical waste.

The following sections present the consumption and emission data reported by the BG plants across the EU that took part to the 2018 FMP data collection (in total 87 plants). The plants from the data collection are listed in Section 11.1.

6.3.2 Energy consumption

Parameters influencing energy consumption in batch galvanising

Degreasing baths are made up of degreasing agents and water. The energy needed for heating the baths to operating temperature is supplied by oil or gas or as electrical energy, depending on local conditions for each individual plant. In many cases the degreasing systems are heated by waste heat recovery and heat exchange.

Pickling baths are usually operated at ambient air temperatures, so no energy is needed for heating. In the case of enclosed pre-treatment pickling, the solution temperature may be up to approximately 40 °C. In this case the baths must be heated. Other energy consumptions in the pickling process result from the operation of auxiliary equipment such as pumps and cranes, although this may be considered negligible. [\[139, EGGA - a 1998\]](#), [\[146, EGGA 2000\]](#)

The flux bath is made up of the flux agent (usually $ZnCl_2 \times NH_4Cl$) and a certain amount of water to yield the right concentration. The flux agent is sometimes formed using KCl in place of some or all of the NH_4Cl . In most cases, energy is needed to heat the flux baths, for which some operators use recovered heat.

Dryers located downstream of the preflux bath consume energy in heating the drying air. Some or all of this energy may be supplied from the flue of the galvanising furnace.

Where large fans are used to blow air through dryers they may require significant amounts of electrical energy and may cause noise. [\[146, EGGA 2000\]](#)

Gas, oil or electric energy provides the energy necessary for melting the zinc and maintaining the temperature of the zinc bath.

Energy consumption reported by BG plants included in the FMP data collection

Energy consumption data were considered confidential business information (CBI) by a number of plant operators. For these plants, it was not possible to include any data in the FMP BREF. Accordingly, only the data corresponding to plants which did not consider the energy

consumption values as confidential are reported in this section. The figures are presented in ascending order of the maximum specific energy consumption values and contain contextual information such as the actual plant code, the type of plant (e.g. general galvanising plant, centrifuge plant), the heat recovery system applied. In addition, information on the BAT applied is included in the figure

Energy consumption (at the plant level)

Figure 6.4 shows the data reported on the specific energy consumption for batch galvanising at the plant level (entire BG plant). The figure contains 3 annual energy consumption values for each plant. In total, 56 batch galvanising plants reported non-CBI data on energy consumption. For these plants, the specific energy consumption was within the range 250 kWh/t to 1 100 kWh/t.

Energy consumption (at the process step level: heating of the galvanising kettle)

In batch galvanising, heating of the galvanising kettle is one of the major process step in terms of energy consumption. Figure 6.6 shows the specific energy consumption for heating of the galvanising kettle process step. In total, 6 batch galvanising plants reported non-CBI data on this process step. The data are also compared with the total energy consumption values for the entire plant in order to evaluate the contribution of the heating process step to the overall energy consumption of the plant. Based on these data, the heating process step typically contributed between 60% to 90% to the overall energy consumption of the plant. For these plants, the specific energy consumption for heating of the galvanising kettle was within the range 180 kWh/t to 1 400 kWh/t.

6.3.3 Material consumption

Degreasing

In batch galvanising, degreasing may be carried out using alkaline or acidic solutions. Figure 6.7 and Figure 6.8 summarise the data reported for the specific consumption of acidic and alkaline degreasing solutions, respectively. Data for 3 operating years in total are reported including the average consumption value over the 3-year period. The figures have been sorted in ascending order of the average specific consumption values and contain relevant contextual information such as, for example, the total volume of the degreasing baths and the degreasing temperature. Typically, the specific consumption of alkaline degreasing solutions ranged from 0.1 kg/t to 2.0 kg/t of steel coated whereas the specific consumption of acidic degreasing solutions was within the range 0.08 kg/t to 1.8 kg/t of steel coated.

Pickling

Pickling baths are prepared by diluting HCl, usually delivered at a concentration of 28 - 32 % w/w (or approx. 320 – 425 g/l HCl), to a working concentration, typically 15 % w/w (or approx. 160 g/l HCl). In some cases pickling inhibitors are added. The average consumption of acid is affected by the quality of the steel input: very low consumption rates can be achieved for clean fabrications as opposed to very high consumption rates for rusty parts. [139, EGGA - a 1998], [146, EGGA 2000]

Figure 6.9 and Figure 6.10 show the data reported on the specific consumption of HCl and the specific consumption of pickling inhibitors, respectively. Data for 3 operating years in total are reported including the average consumption value over the 3-year period. Specific HCl consumptions are expressed in kg of 28 %-wt HCl per tonne of coated steel. The figures have been sorted in ascending order of the average specific consumption values and contain relevant contextual information such as, for example, the total volume of the pickling baths and the pickling bath temperatures. In addition, the type of steel items that are galvanised is specified (e.g. centrifuge items, steel products for various size range) including the share of each type of item processed in the plant expressed in percentage. Typically, the specific consumption of HCl ranged from 1.2 kg/t to 50.7 kg/t of steel coated and the specific consumption of pickling inhibitors ranged from 0.01 kg/t to 0.09 kg/t of steel coated.

- Specificity of BG plants processing workpieces with high specific surface area. [[151, DE 2019](#)]

In the FMP BREF, the acid consumption is expressed in kg/t of batch galvanised steel. However, the acid consumption also depends greatly on the specific surface (m^2/t) of the components to be galvanised. For instance, the specific surface of small or thin-walled workpieces is much higher than the specific surface of typical workpieces processed in batch galvanising such as steel structures (e.g. steel beam, hollow sections). In this case, the following specific surface areas are generally observed:

- steel beam IPE 100 = $49.3 \text{ m}^2/\text{t}$;
- steel beam IPE 200 = $34.4 \text{ m}^2/\text{t}$;
- steel beam IPE 600 = $16.4 \text{ m}^2/\text{t}$;
- steel beam HE 300 M = $7.7 \text{ m}^2/\text{t}$;
- steel beam HE 400 B = $12.4 \text{ m}^2/\text{t}$;
- hollow section 100 x 100 x 3.0 mm = $44.5 \text{ m}^2/\text{t}$;
- hollow section 200 x 200 x 6.3 mm = $20.6 \text{ m}^2/\text{t}$.

On the other hand, thin-walled components, in particular cable trays, used for electrical installations can have specific surface areas well above $50 \text{ m}^2/\text{t}$. Cable trays have the largest specific surface area which can be up to $350 \text{ m}^2/\text{t}$. These types of BG plants were not included in the FMP data collection.

In addition, thin-walled components are usually attached to jigs and chains for hot-dip galvanising. Therefore, the jigs and chains are also galvanised and need to be stripped (zinc removal) with hydrochloric acid after hot-dip galvanising. This also leads to an increased acid consumption.

As an example, in Germany, there are at least two very modern batch galvanising plants that require the use of 43.6 kg and 45.4 kg of hydrochloric acid (28 %) per tonne of hot-dip galvanised material, respectively. These two plants produce in very high quantities (12 500 tonnes/year and 17 500 tonnes/year) cable trays, cable tray systems and accessories for electrical installations. The cable trays have a very small sheet thickness (e.g. less than 1.0 mm). Within the product mix of these plants, there are specific surface areas within the range $50\text{-}350 \text{ m}^2/\text{t}$.

- Specificity of BG plants processing used galvanised articles (regalvanising). [[152, EGGA 2021](#)]

Some BG plants process used galvanised articles (e.g. highway guard rails) that are returned to be galvanised after long service periods. These types of regalvanising BG plants were not included in the FMP data collection. The processing of these articles requires additional process steps due to the presence of partly corroded surfaces or the need to remove any residual zinc coating. Such plants may exhibit specific consumption of HCl up to 50 kg/t of steel coated.

Fluxing

Figure 6.11 shows the data reported on the specific consumption of fluxing agents at the batch galvanising plants of the FMP data collection. Data for 3 operating years in total are reported including the average consumption value over the 3-year period. The figures have been sorted in ascending order of the average specific consumption values and contain relevant contextual information such as, for example, the type of fluxing (dry or wet), total volume of the fluxing baths and the fluxing baths temperatures. Typically, the specific consumption of fluxing agents ranged from 0.03 kg/t to 5.6 kg/t of steel coated.

Hot dipping

The main raw material input for the dipping process is, of course, the coating metal zinc. Extreme figures in zinc consumption - high or low - can be attributed to the shape of the fabricated steel and the quality of the coating. Zinc consumption is, of course, proportional to the surface coated and the thickness of the coating. [139, EGGA - a 1998]

6.3.4 Water consumption

In batch galvanising, fresh water is only used for the initial preparation of the treatment baths (degreasing, pickling, stripping, rinsing, fluxing) and post treatment baths and as make-up water to compensate for evaporation. Furthermore, no wastewater is generated.

6.3.5 Emissions to air

Measurements reported without giving information about the oxygen level measured or the fuel composition used are not taken into account.

6.3.5.1 Emissions to air from heating and feedstock drying

The combustion of fuels to heat the galvanising furnace results in emission of combustion products such as CO, CO₂, and NO_x (also, with oil combustion, SO_x). Combustion air fans and burners may also produce noise. [146, EGGA 2000], [150, Danish EPA 1993]

NO_x and CO emissions

The data reported on NO_x and CO emissions to air from heating the galvanising kettle are shown in Figure 6.12. Figure 6.12 is composed of several sections. The upper part of the figure shows the NO_x emission concentrations at an oxygen reference level of 3 %, for each emission point over the four-year reporting period. Measurements reported without information about the oxygen level measured or the fuel composition were not taken into account. A secondary y-axis is used to present the maximum CO concentration and the CO concentration corresponding to the maximum NO_x emission concentration over the reporting period. Below the x-axis, contextual information such as, for example, the temperature range or the fuel used (light oil or natural gas) is presented along with relevant BAT candidates for NO_x emissions control. In the lower part of the graph, the NO_x and CO mass flows are plotted as well as the measured oxygen reference level corresponding to the maximum NO_x and corresponding CO emission concentrations.

The emissions of NO_x from heating the galvanising kettle were reported for 30 plants (32 emission points in total). The NO_x emission concentrations ranged from 4.0 mg/Nm³ to 994 mg/Nm³ and the NO_x emission loads ranged from 0.005 kg/h to 1.7 kg/h.

The emissions of CO from heating the galvanising kettle were reported for 26 emission points. The CO emission concentrations ranged from 1.0 mg/Nm³ to 3 560 mg/Nm³ and the CO emission loads ranged from 0.002 kg/h to 6.0 kg/h.

The data reported on NO_x and CO emissions to air from feedstock drying are shown in Figure 6.13. Only 3 plants reported measurements about NO_x and CO emissions to air from feedstock drying, with a total of 7 measurements. However, 6 out of 7 measurements reported a measured oxygen value above 18% which may affect the emission values after being corrected at 3% (unusual high emission concentrations). The NO_x emission concentrations for feedstock drying ranged from 50 mg/Nm³ to 290 mg/Nm³, and the CO emission concentrations ranged from 49 mg/Nm³ to 304 mg/Nm³.

Concerning feedstock drying, dust emissions were not considered relevant because all the plants from the data collection reported the use of natural gas with very low dust emissions.

6.3.5.2 Emissions to air from pickling

Hydrogen chloride emissions arise from the pickling baths in different quantities, depending on the temperature and the concentration of the bath. These acid fumes are usually diffuse emissions. Extraction measures (e.g. lip extraction) or waste gas scrubbing are generally not applied, because general plant ventilation systems can keep the concentration of HCl within the workplace air below permitted limits [144, ABAG 1993]. However, plants operating enclosed pre-treatment sections are special cases, which sometimes operate with higher acid temperatures. In this case, the enclosure is extracted and the waste gas is usually scrubbed.

HCl emissions

The data reported on HCl emissions to air from pickling in the batch galvanising plants of the FMP data collection are shown in Figure 6.14. The emissions of HCl were reported for 44 plants in total (representing 46 emission points). The HCl emission concentrations ranged from 0.03 mg/Nm³ to 19 mg/Nm³ and the HCl emission loads ranged from 0.03 g/h to 600 g/h.

6.3.5.3 Emissions to air from hot dipping

The galvanising kettle is one of the major sources of emissions to air from the batch galvanising process. During hot dipping, vapour, gas and particulate pollutants rise from the zinc bath and can be seen as a white cloud within the kettle enclosure. Depending on the fluxes, the emissions comprise extremely fine sublimation and vaporisation products including ions of chlorine, ammonia and zinc, as well as the compounds zinc oxide, zinc chloride and ammonium chloride.

The kind and amount of emissions depend on the consumption of the flux, its composition and additional factors determined by the parts to be galvanised (kind, number, surface area/quality) and their pre-treatment (degreasing, pickling, rinsing, drying). Some sources reported the size of hygroscopic particles to be very small, mostly < 1 micron. While others reported that the average particle size was 30 microns and only about 5 % being < 1 micron [103, FI, TWG member 2000].

According to investigations on the distribution of particle sizes in airborne particulate emissions from the galvanising bath following dipping of steel, there are no health concerns over particle size and mass of emissions to which galvanising operators may be exposed during the process of galvanising. The investigation showed that the personal exposure monitoring data of the operators is both low in total mass, especially so in the case of 'low -fuming fluxes' or 'smoke reduced fluxes' and that the mass of small particles of less than 1 micron diameter is the same for both normal fluxes and 'low fuming fluxes'. Therefore there are no health concerns between the different flux types and no concerns over the size of the airborne particulate in any event. [153, Piatkiewicz 1999]

If, as a result of process upset, the degreasing operation is inefficient, it is possible for oil or grease to enter the zinc bath and be subject to low temperature combustion. In this case, the filter dust may contain up to 10 % grease. [140, UK Galvanisers 2000], [143, EGGA 1999], [144, ABAG 1993], [150, Danish EPA 1993]

The waste gas is either treated in fabric filters, resulting in filter dust, or is scrubbed, giving rise to an aqueous effluent which is normally treated. In addition to dust, small volumes of gaseous substances such as hydrogen chloride and ammonia are emitted, originating from the decomposition of the fluxing agent and recombination of ammonium chloride as airborne particulate. [140, UK Galvanisers 2000]

In tube galvanising, the removal of excess zinc from the tube surfaces, by blowing compressed air or watersteam, leads to emissions of zinc and zinc containing dusts.

Dust emissions

The data reported on dust emissions to air from hot dipping in the batch galvanising plants of the FMP data collection are shown in Figure 6.15. The emissions of dust were reported for 83 emission points. The dust emission concentrations ranged from 0.02 mg/Nm³ to 21.6 mg/Nm³ and the emission loads ranged from 0.004 kg/h to 0.7 kg/h.

The reported data on dust emissions to air from hot dipping using low-fume flux are shown in Figure 6.16. The emissions of dust were reported for 8 plants in total. The dust emission concentrations ranged from 0.04 mg/Nm³ to 14.1 mg/Nm³ and the dust emission loads ranged from 0.009 kg/h to 0.7 kg/h.

6.3.6 Residues

Degreasing

Degreasing results in chemical waste in the form of discarded baths and sludge. The amount of spent degreasing liquor to be discarded depends on the quantity of steel degreased and the degree of pollution. It correlates with the maximum working lifetime of the degreasing solution, which is usually 1-2 years. [144, ABAG 1993] Other sources report a maximum lifetime of degreasing baths of up to 7 years. [143, EGGA 1999], [146, EGGA 2000]

Used alkaline degreasing baths contain sodium hydroxide, carbonates, phosphates, silicates, surfactants and free and emulsified oil and grease. Used acidic degreasing baths contain, apart from free and emulsified oil and grease, diluted hydrochloric and/or phosphoric acid, emulsifiers and corrosion protection inhibitors.

Spent degreasing baths are usually chemically and physically treated by special contractors (disposal companies). The emulsion is split into an oil-rich and an oil-poor phase. The aqueous, low-oil part is further treated, while the oil-rich part has to be disposed according to waste regulations. [144, ABAG 1993]

Pickling

Wastes generated in pickling are spent pickle liquor and sludge. Spent pickle liquor consists of free acid, iron chloride (up to 140 - 170 g Fe/t), zinc chloride, alloying elements of the pickled steel and, sometimes, pickling inhibitors. Where stripping and pickling are done in the same bath, mixed pickle liquor is generated, with high zinc and iron contents. If degreasing is done in the pickling bath, free and emulsified oil and grease are also present. The average composition of spent pickling baths are given in Table 6.3.

Table 6.3: Composition ranges of spent pickle baths

	Pickling	Pickling (including stripping)
Iron (as FeCl ₂) ¹	< 140 g/l	< 140 g/l
Zinc	5 – 10 g/l ²	20 – 40 g/l
HCl (free acid)	30 – 50 g/l	30 – 50 g/l
Pickle inhibitor	approx. 50 ppm (1 l inhibitor per 20 m ³ pickle liquor)	
Oil, grease, surfactants	n.a. (carry-over from degreasing baths)	
Note: Source: [144, ABAG 1993]		
¹ Ratio of FeCl ₃ : FeCl ₂ is about 1:50 according to [144, ABAG 1993], while [145, DK, TWG member 1999] reports the ratio of FeCl ₃ : FeCl ₂ is < 1:1000.		
² Requirements set by recycling companies are usually more stringent.		

Stripping operation using hydrochloric acid also generates waste acids, but with a different composition from those originating from pickling. If stripping is carried out in an acidic bath

separate from the pickling baths then zinc chloride relatively uncontaminated by iron chloride is generated in the stripping bath. The average composition of spent stripping baths are given in Table 6.4. This solution can be recycled to the preflux (zinc ammonium chloride) bath. [146, EGGA 2000], [154, FI, TWG member 1999]

Iron chloride- and zinc chloride-containing solutions from combined pickling and stripping can be used in the fertiliser industry. Although attention has to be paid to zinc addition to agricultural soils and the fact that statutory limits are not exceeded. [140, UK Galvanisers 2000], [154, FI, TWG member 1999]

Table 6.4: Composition range of spent stripping baths

	Stripping
Iron (as FeCl ₂)	< 10 % of zinc content ¹
Zinc (as ZnCl ₂)	160 – 200 g/l
HCl (free acid)	< 10 g/l
Pickle inhibitor	approx. 50 ppm (1 l inhibitor per 20 m ³ pickle liquor)
Oil, grease, surfactants	n.a. (carry-over from degreasing baths)
¹ Required by recycling company, can only be achieved by use of pickle inhibitors	
Source: [144, ABAG 1993]	

Fluxing

Waste arising from fluxing operation includes discarded fluxing liquor and sludge. [150, Danish EPA 1993]

Flux baths which are not continuously regenerated increase in acidity and iron content as they are used. They contain (depending on the flux agent) ammonia chloride, zinc chloride and /or potassium chloride. Batch recycling of preflux solution is common practice. In some cases, the used solution is returned to the preflux producer on a regular basis. [143, EGGA 1999], [146, EGGA 2000]

Hot dipping

During hot dipping, zinc-containing solid by-products such as hard zinc, ash and squirts arise.

Bottom dross (or hard zinc) is formed in the zinc bath during operation as a reaction product of the molten zinc with iron (from the workpieces of the vessel walls) or with iron salts carried over from pickling and fluxing. Because of its higher density, bottom dross accumulates at the bottom of the kettle from where it is periodically removed. Because of a high zinc content (95 to 98 %), the bottom dross is sold to recycling companies for recovery.

Zinc ash with a lower density is floating on the surface of the galvanising bath and consists mainly of zinc oxide and zinc chloride, with some aluminium oxide if alloyed to the metal bath. Zinc ash is skimmed off before removing the dipped work-pieces, usually carrying large amounts of zinc out as well. Zinc content is 40 to 90 % and makes it valuable for recycling either directly in the plant or by secondary zinc industry. [103, FI, TWG member 2000], [144, ABAG 1993], [149, Wedge Group 2000]

Flux skimmings arise from wet galvanising when the flux blanket becomes inactive and needs to be removed from the surface of the zinc bath. Metallic zinc may be entrained during the skimming, and a zinc content of up to 50 % may occur.

From time to time small amounts of metallic zinc are ejected from the kettle, as a result of evaporation of moisture from the surface of the steel. They mostly adhere to the fume extraction equipment (if existing) from which they are removed for recovery of their metallic content. [143, EGGA 1999] **Splashed zinc** can be remelted directly in the galvanising bath or be sent for

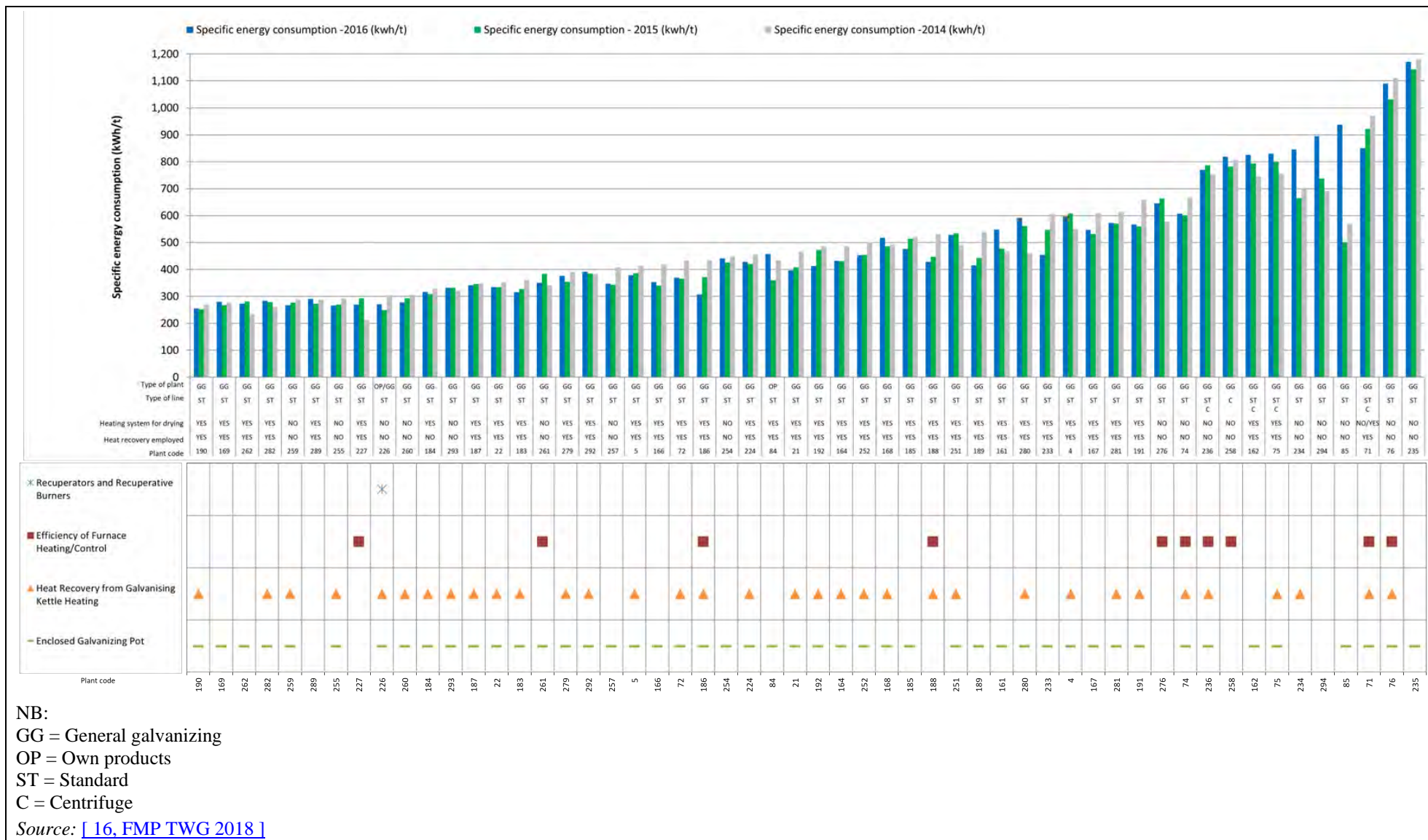
recovery off site. It may contain zinc oxide and/or be contaminated by hitting the floor if the kettle is not enclosed. [144, ABAG 1993]

Figure 6.17 to Figure 6.23 show the data reported by the plants in the FMP data collection concerning the specific generation of the following residues generated in batch galvanising:

- spent alkaline degreasing solution;
- spent acidic degreasing solution;
- oily sludge from alkaline degreasing solution;
- oily sludge from acidic degreasing solution;
- spent HCl from pickling;
- spent flux;
- bottom dross;
- zinc ash.

Figure 6.17 to Figure 6.23 present the data in ascending order of the maximum average specific generation values for the three operating years. Specific residue generation data are expressed in kg/t of steel coated. Below the x-axis, relevant contextual information is included such as, for example, the classification of the material (e.g. hazardous) or the destination of the residue (e.g. landfill, recovery, external treatment).

6.3.7 Figures with consumption and emission levels



NB:
 GG = General galvanizing
 OP = Own products
 ST = Standard
 C = Centrifuge
 Source: [16, FMP TWG 2018]

Figure 6.4: Specific energy consumption (kWh/t of feedstock processed) in batch galvanising

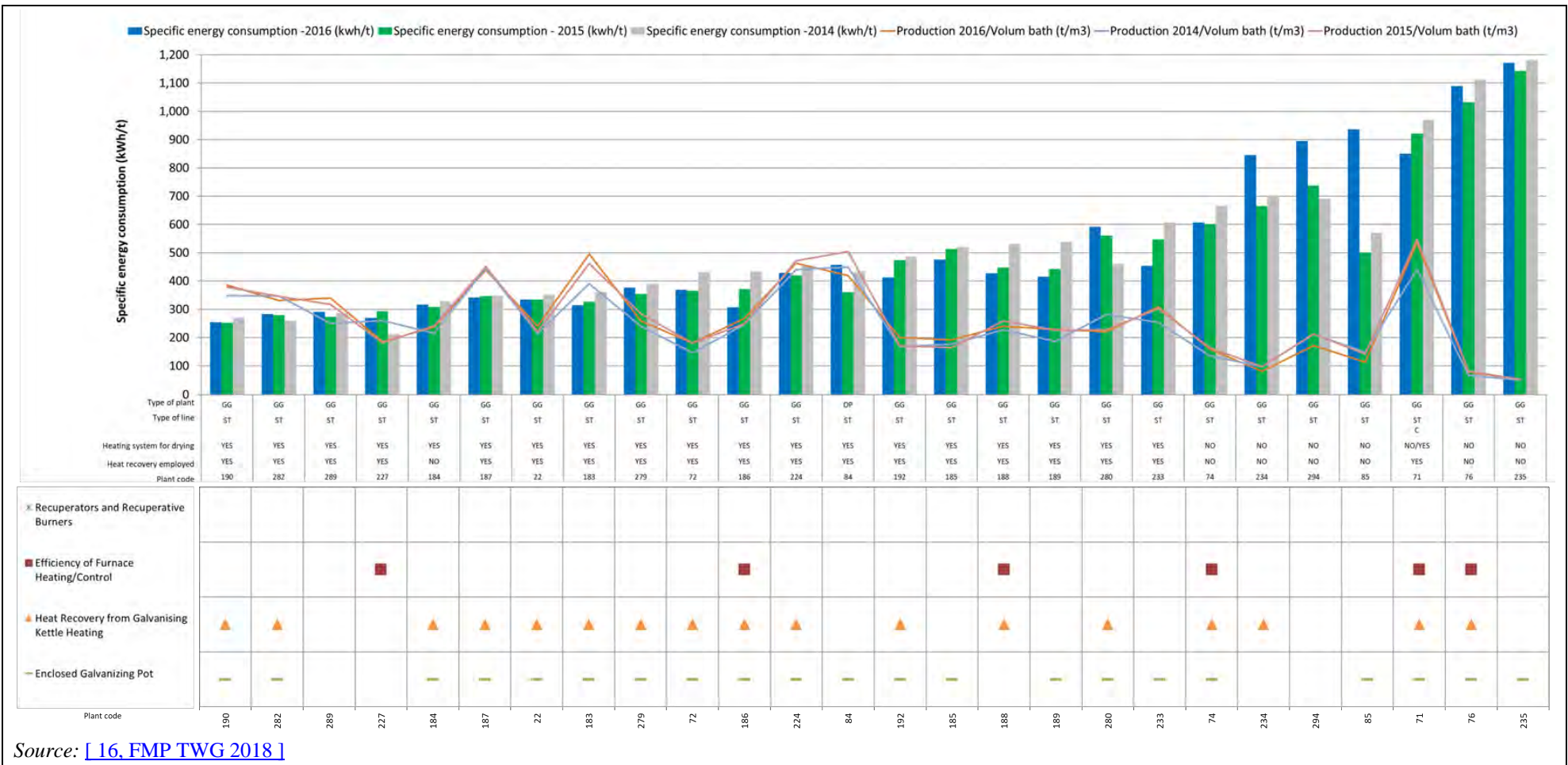


Figure 6.5: Specific energy consumption (kWh/t of feedstock processed) in batch galvanising including the yearly production throughput (production/hot dipping bath volume)

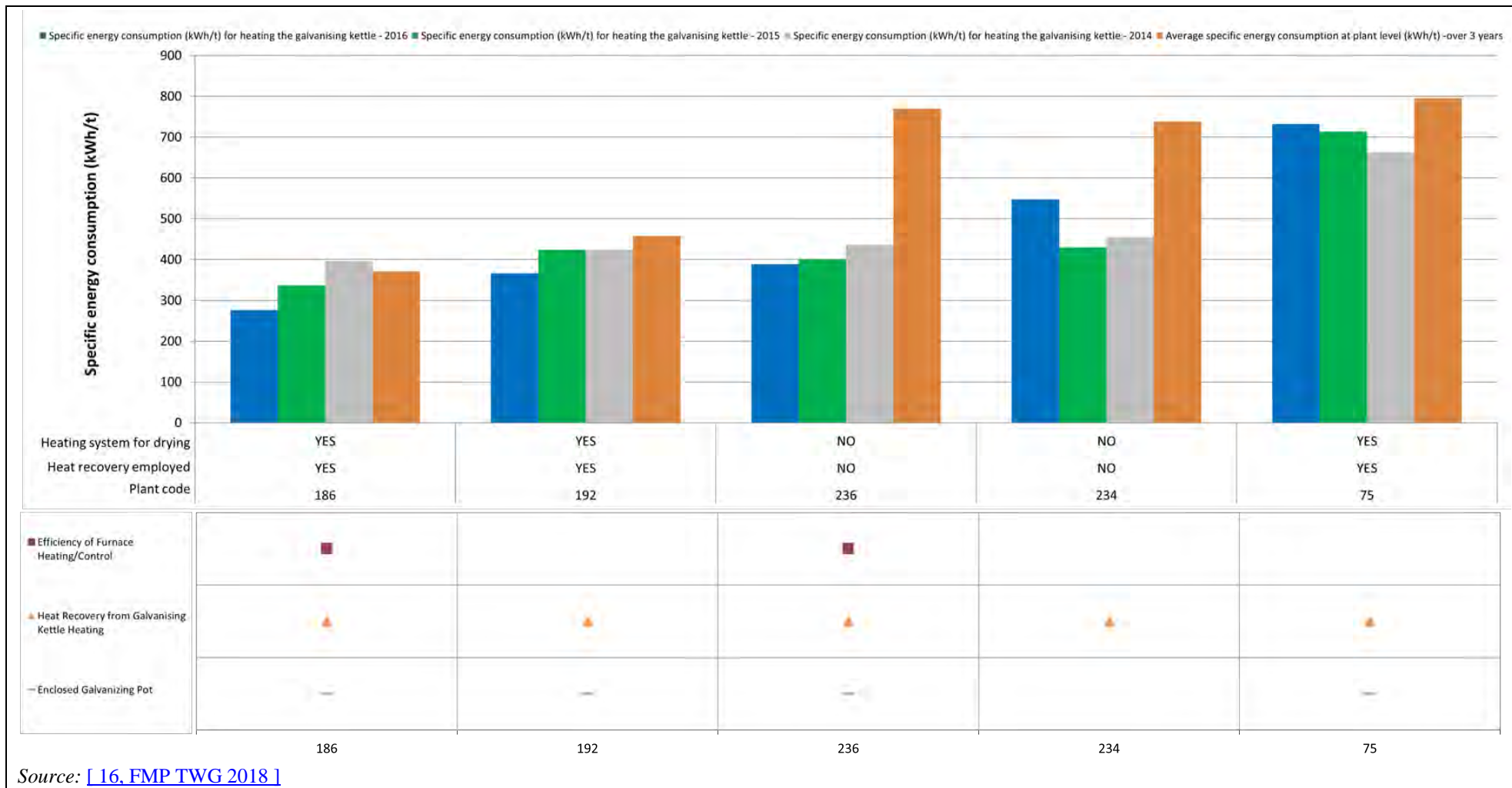
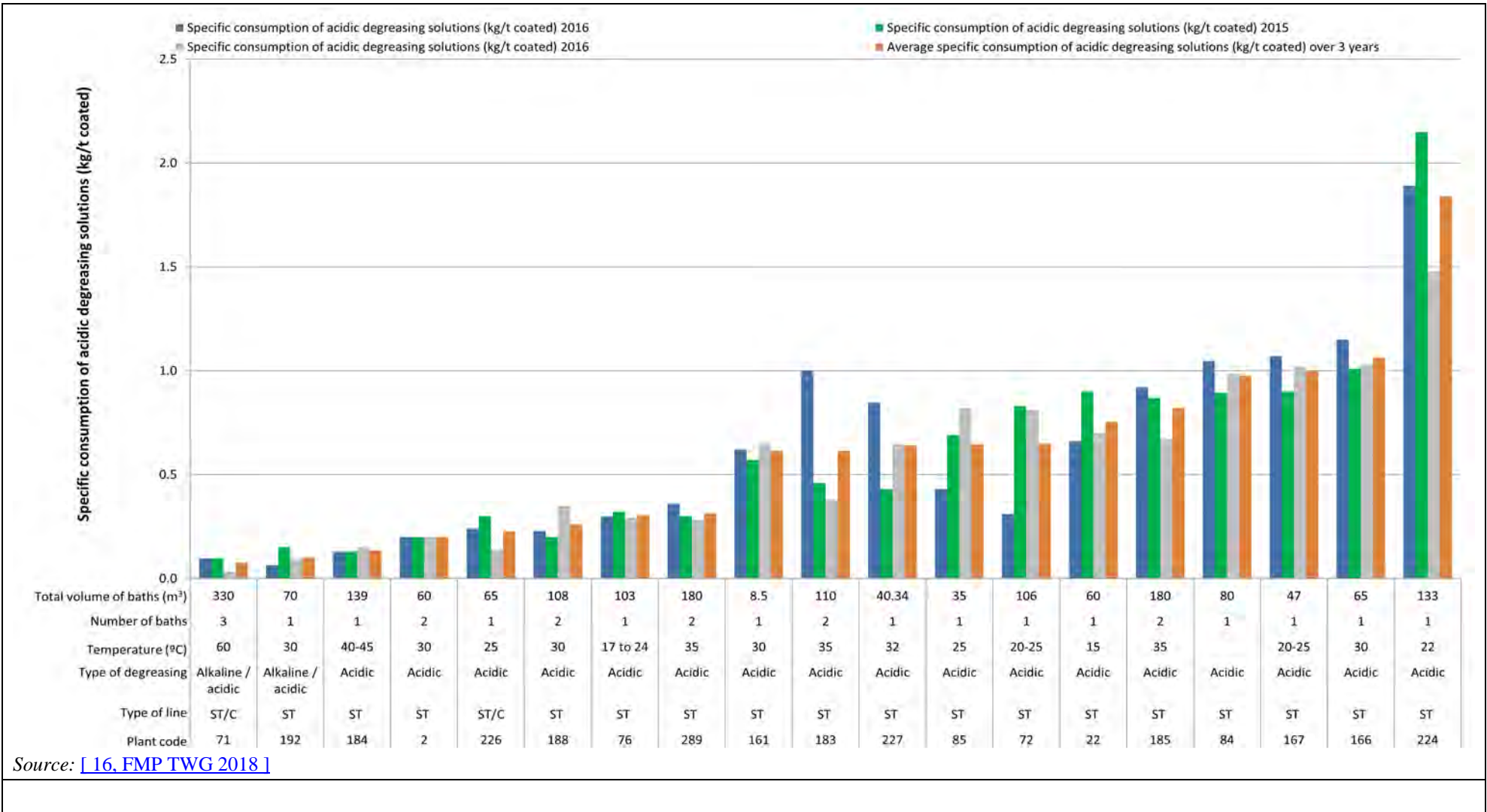


Figure 6.6: Specific energy consumption (kWh/t of feedstock processed) for heating of the batch galvanising kettle



Source: [16, FMP TWG 2018]

Figure 6.7: Specific consumption (kg/t of steel coated) of acidic degreasing solutions in batch galvanising plants

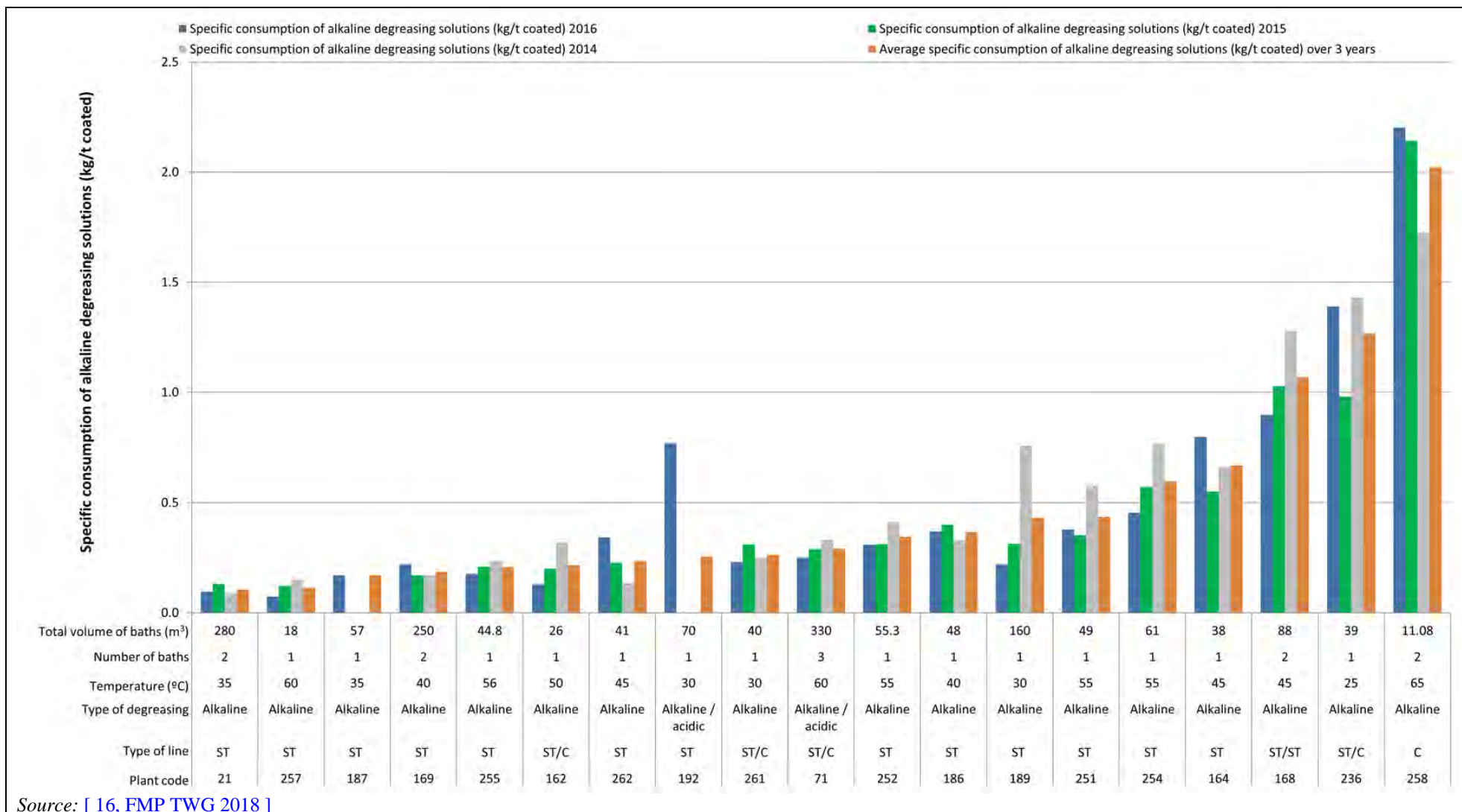
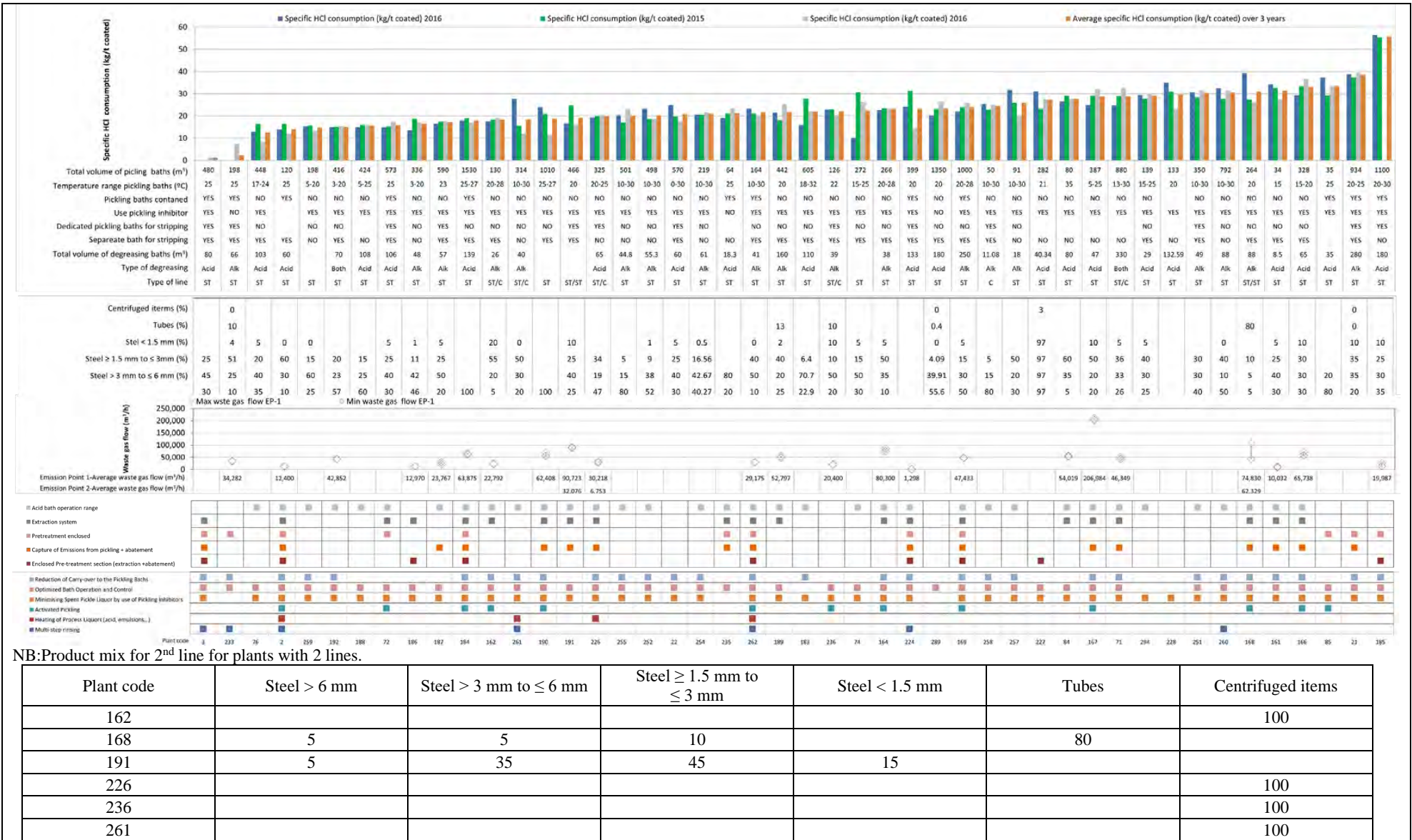


Figure 6.8: Specific consumption (kg/t of steel coated) of alkaline degreasing solutions in batch galvanising plants



NB: Product mix for 2nd line for plants with 2 lines.

Plant code	Steel > 6 mm	Steel > 3 mm to ≤ 6 mm	Steel ≥ 1.5 mm to ≤ 3 mm	Steel < 1.5 mm	Tubes	Centrifuged items
162						100
168	5	5	10		80	
191	5	35	45	15		
226						100
236						100
261						100

Source: [16, FMP TWG 2018]

Figure 6.9: Specific HCl consumption (kg/t of steel coated) in pickling in batch galvanising plants

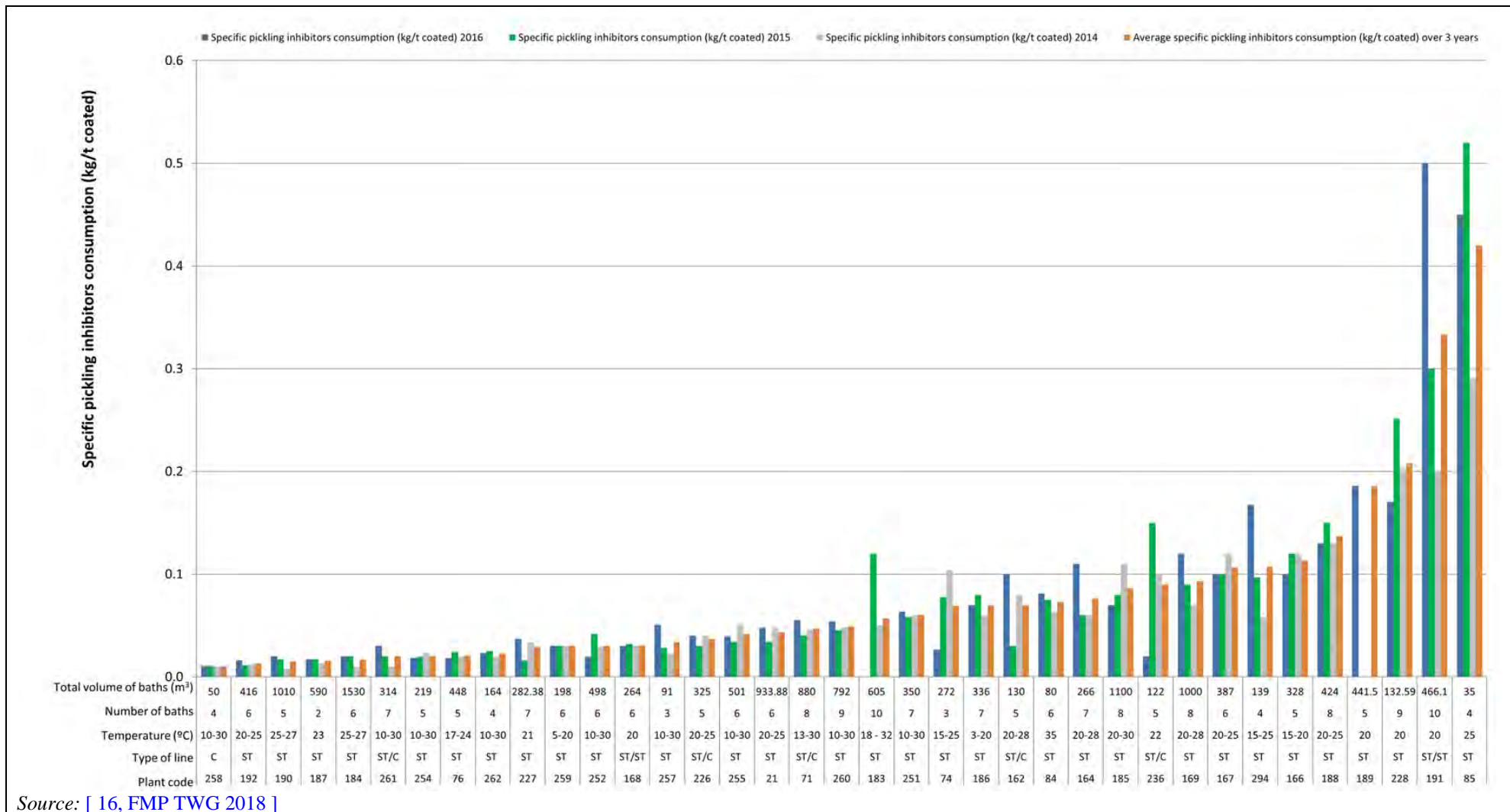
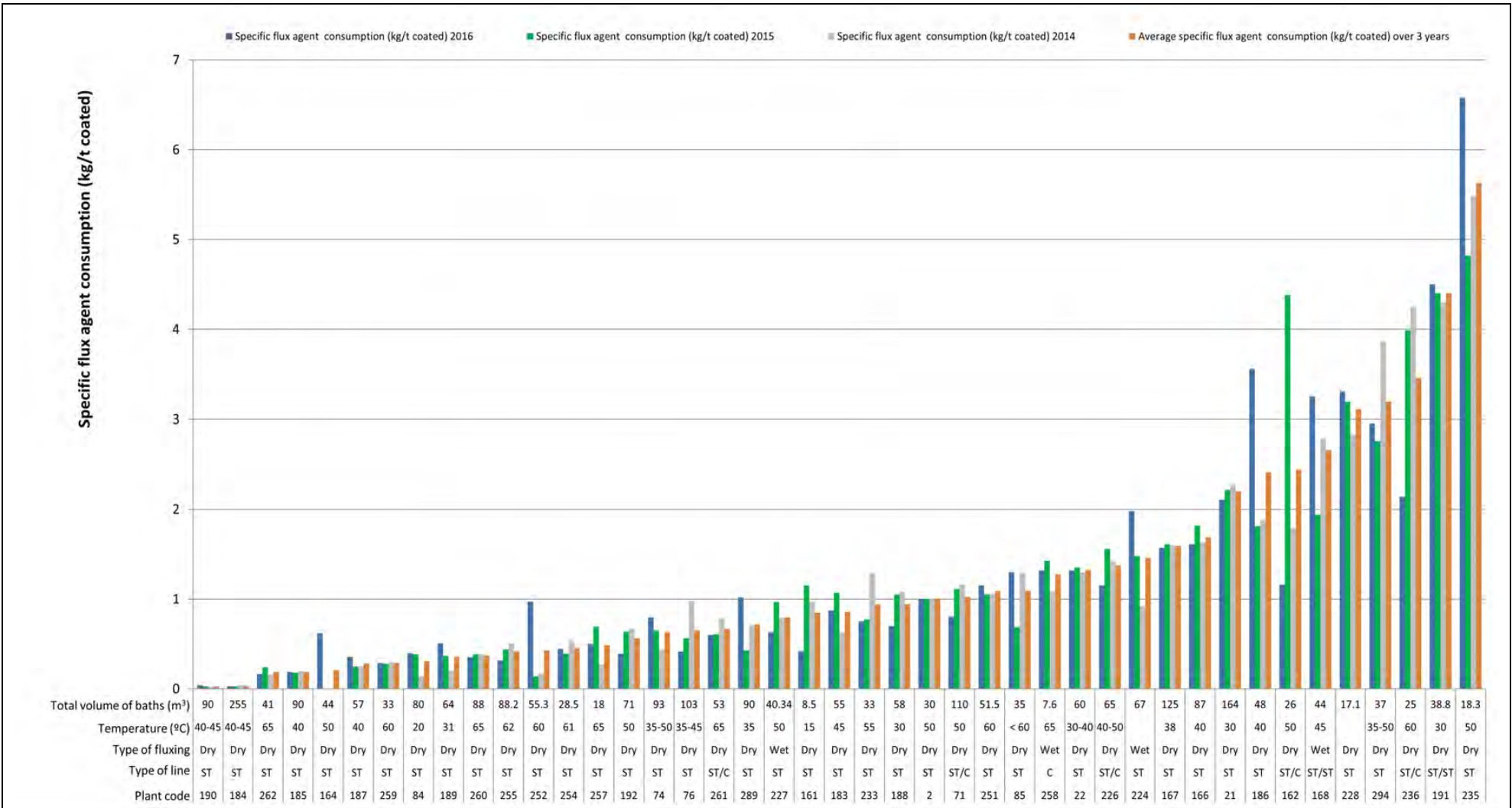
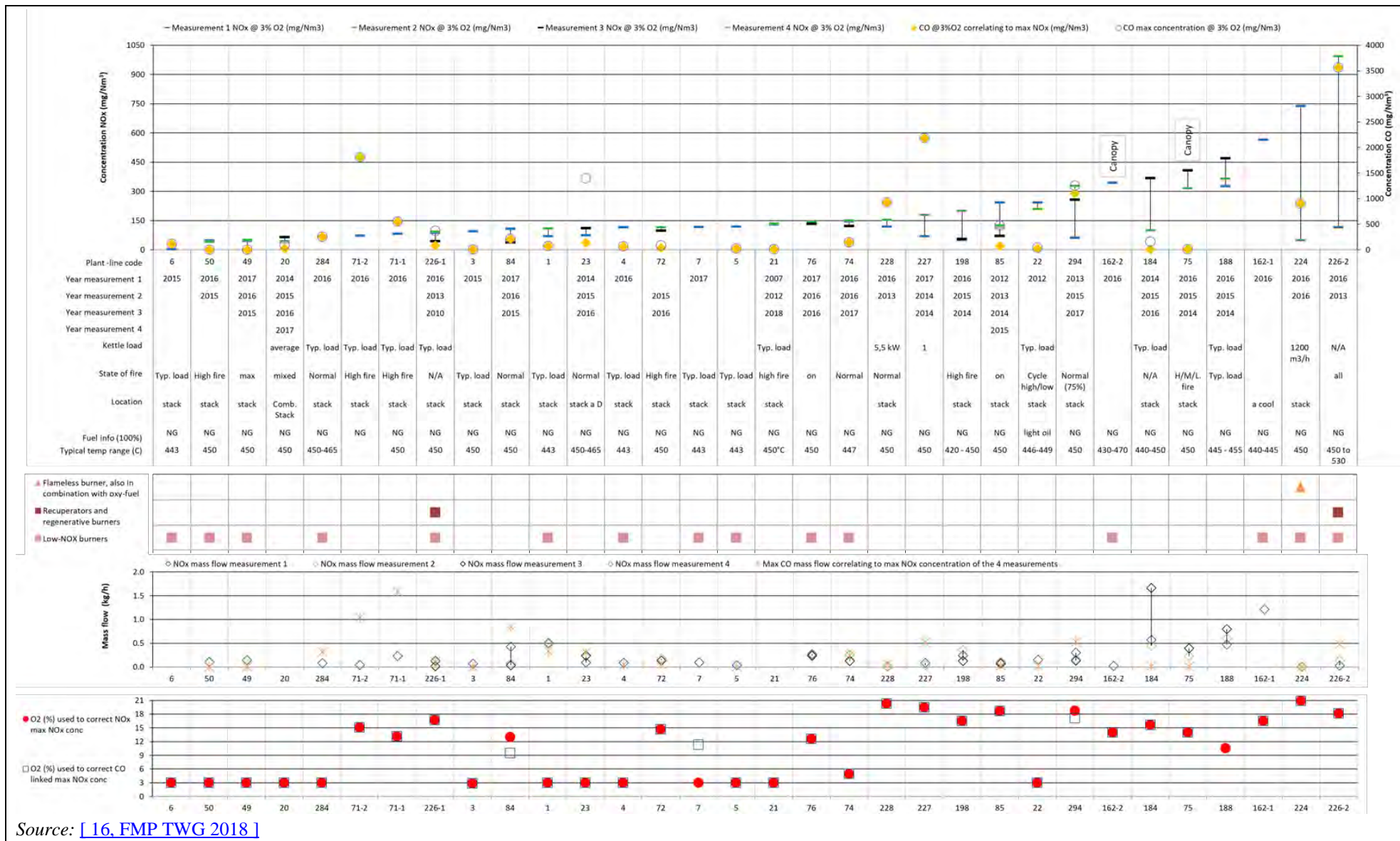


Figure 6.10: Specific pickling inhibitors consumption (kg/t of steel coated) in pickling in batch galvanising plants



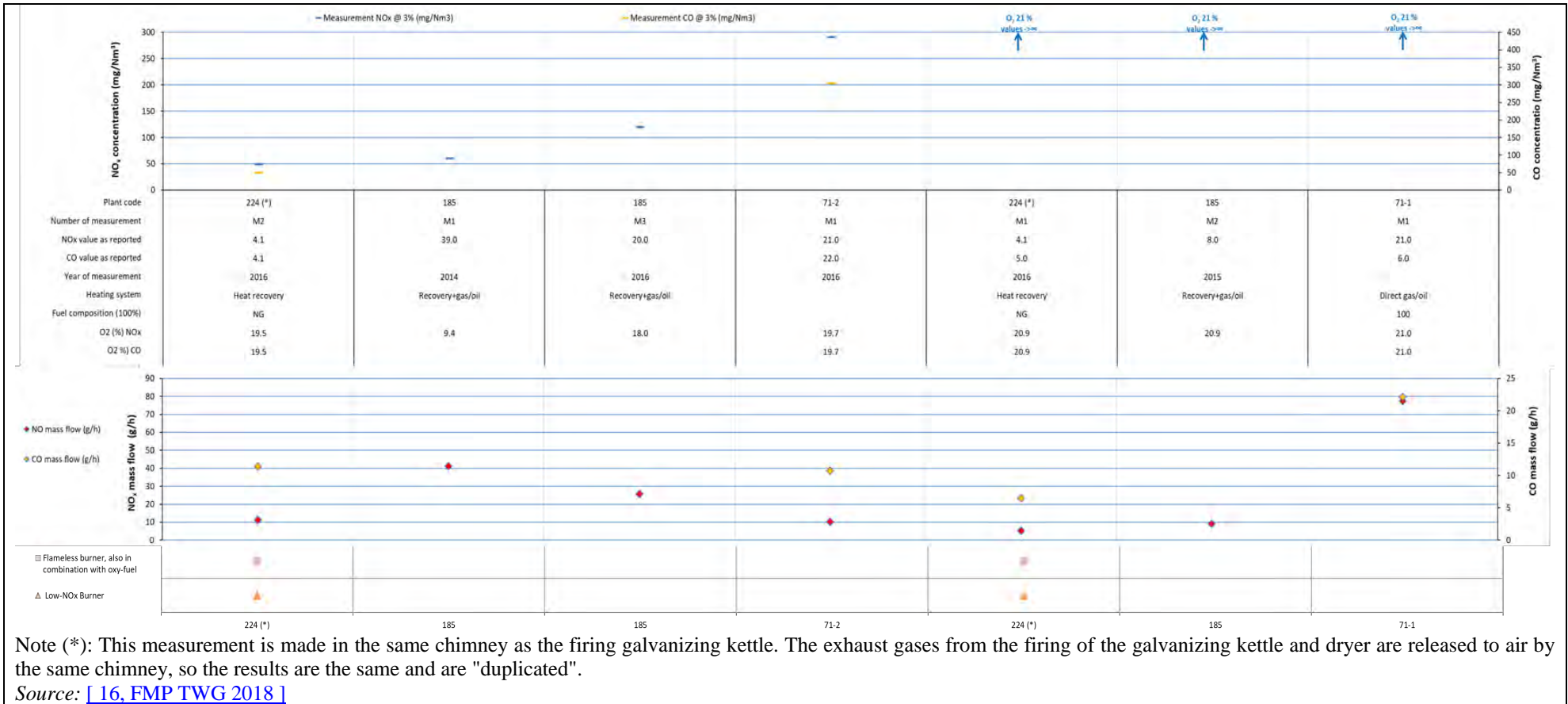
Source: [16, FMP TWG 2018]

Figure 6.11: Specific flux agent consumption (kg/t of steel coated) in pickling in batch galvanising plants



Source: [16, FMP TWG 2018]

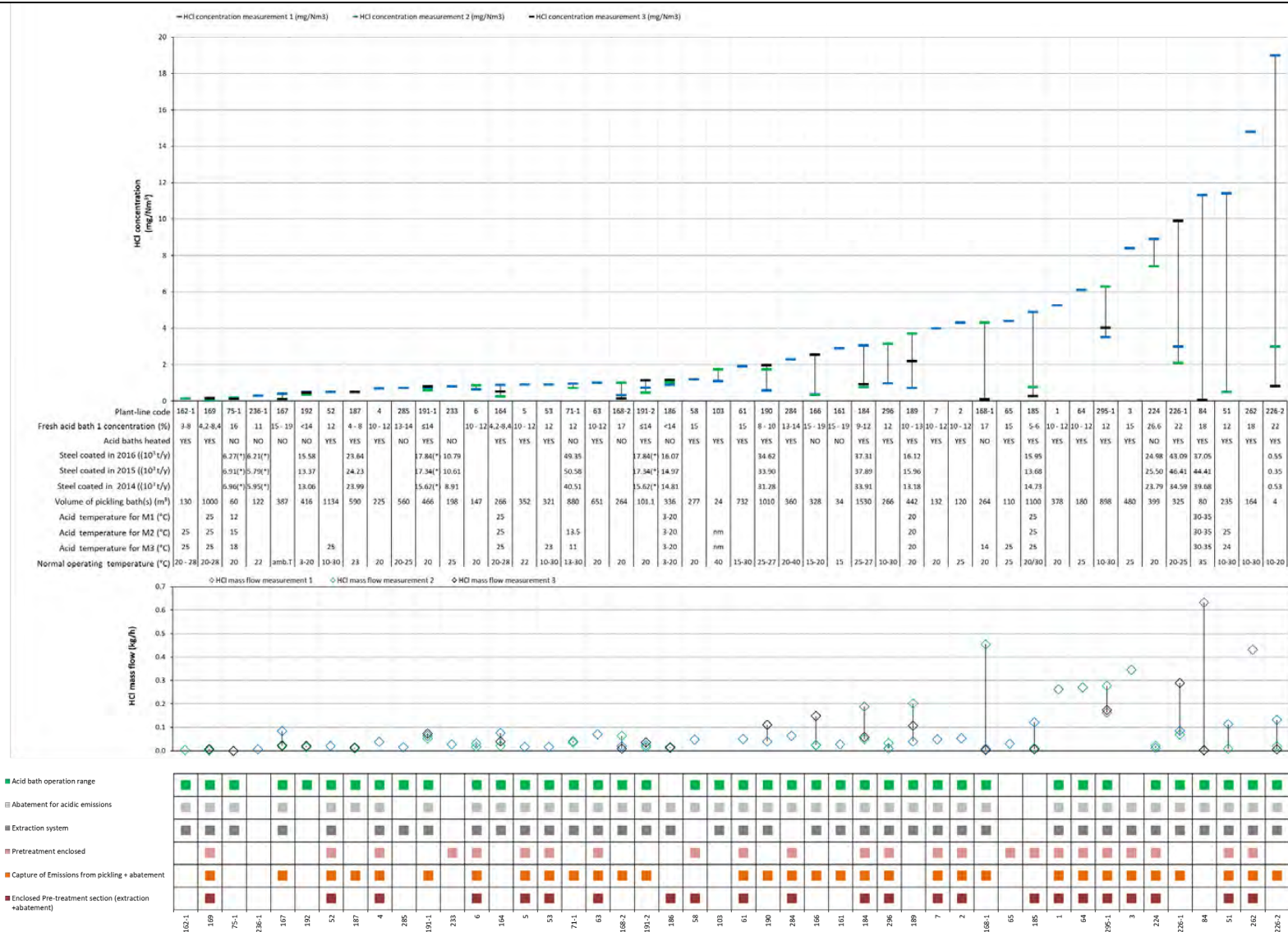
Figure 6.12: NO_x and CO emissions from heating the galvanising kettle (in mg/Nm³ at 3 % oxygen)



Note (*): This measurement is made in the same chimney as the firing galvanizing kettle. The exhaust gases from the firing of the galvanizing kettle and dryer are released to air by the same chimney, so the results are the same and are "duplicated".

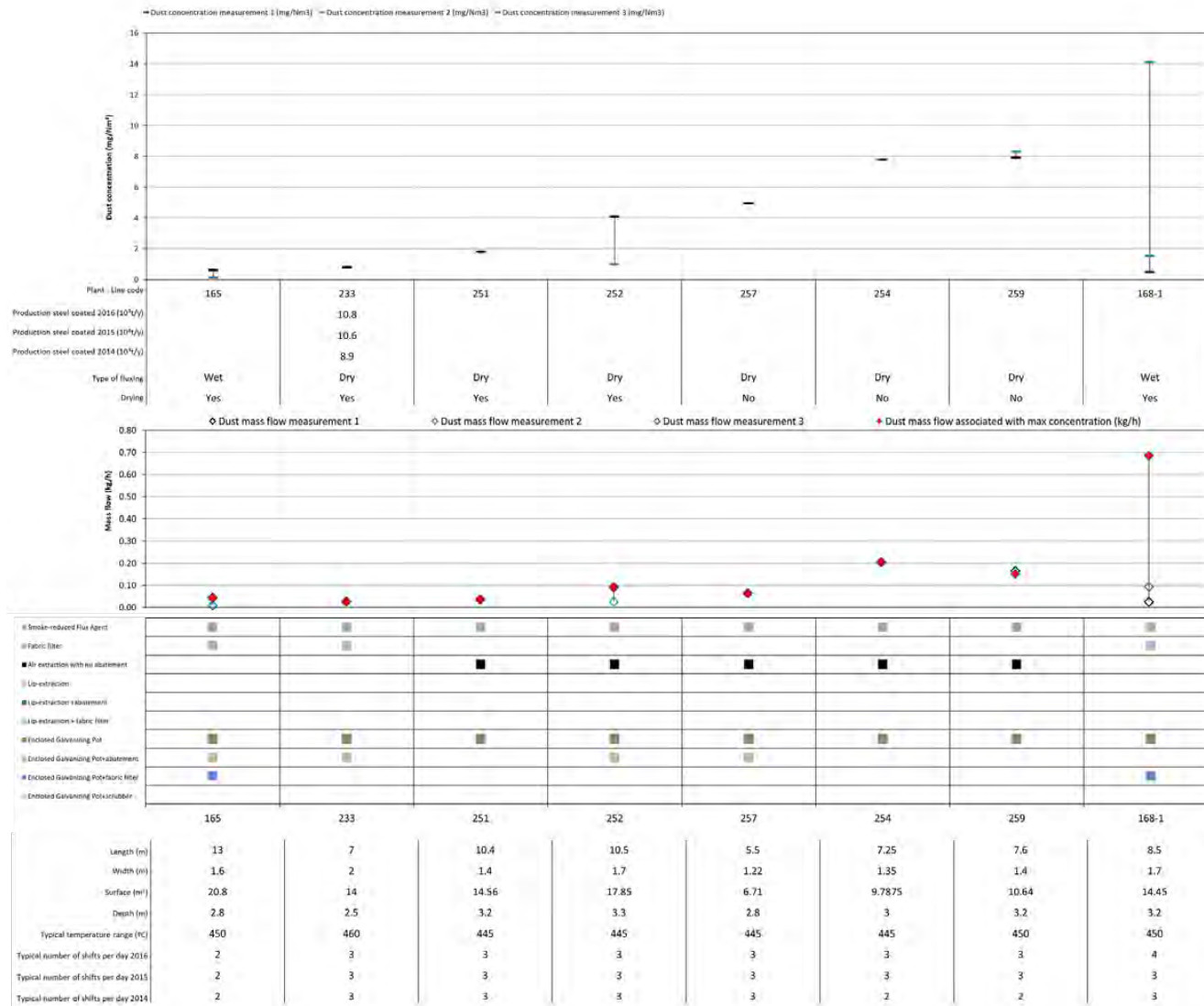
Source: [16, FMP TWG 2018]

Figure 6.13: NOx and CO emissions from feedstock drying (in mg/Nm³ at 3 % oxygen)



Source: [16, FMP TWG 2018]

Figure 6.14: HCl emissions from pickling (in mg/Nm³) in batch galvanising plants



Source: [16, FMP TWG 2018]

Figure 6.16: Dust emissions from hot dipping (in mg/Nm³) in batch galvanising plants using low-fume flux

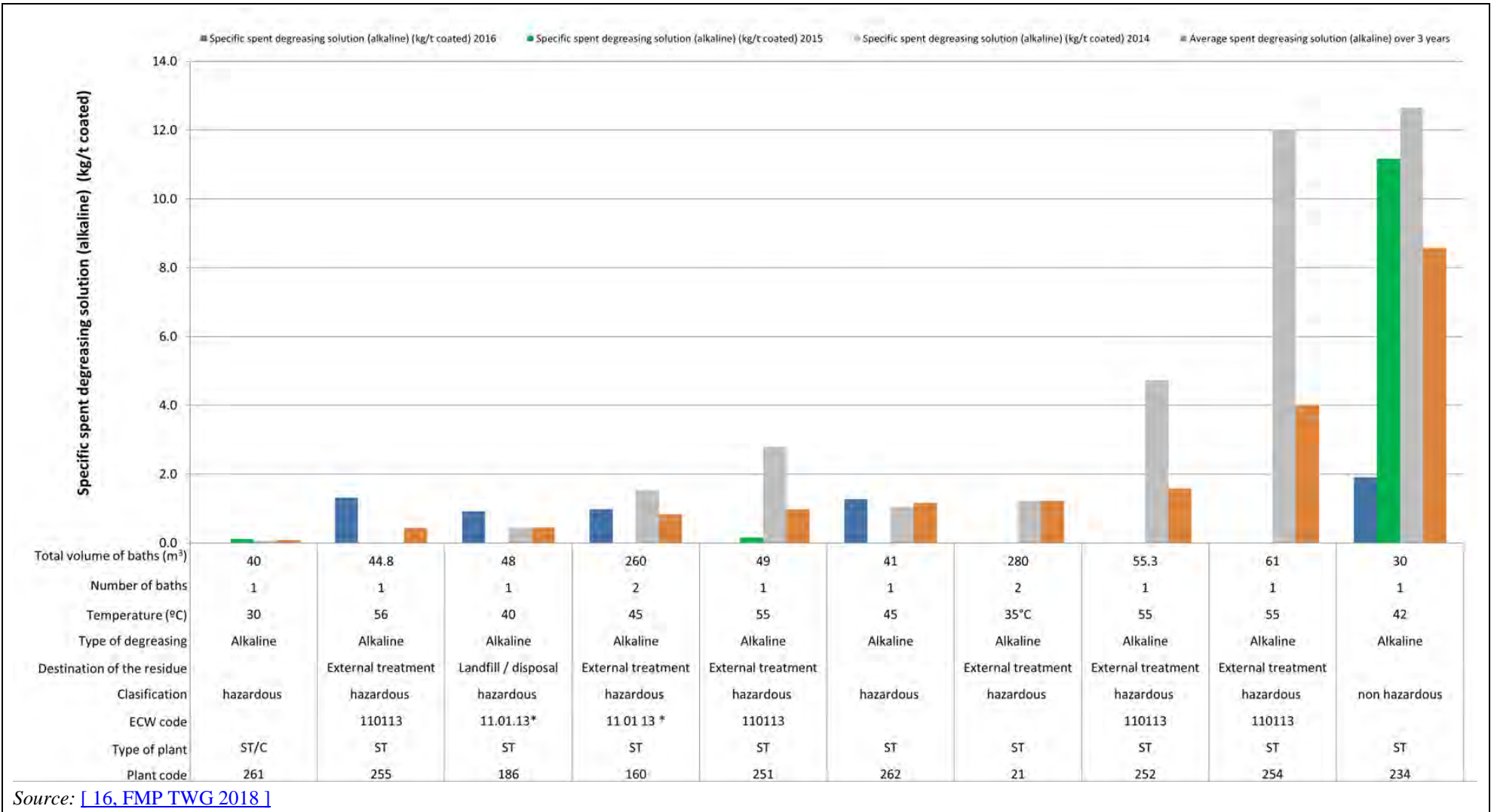
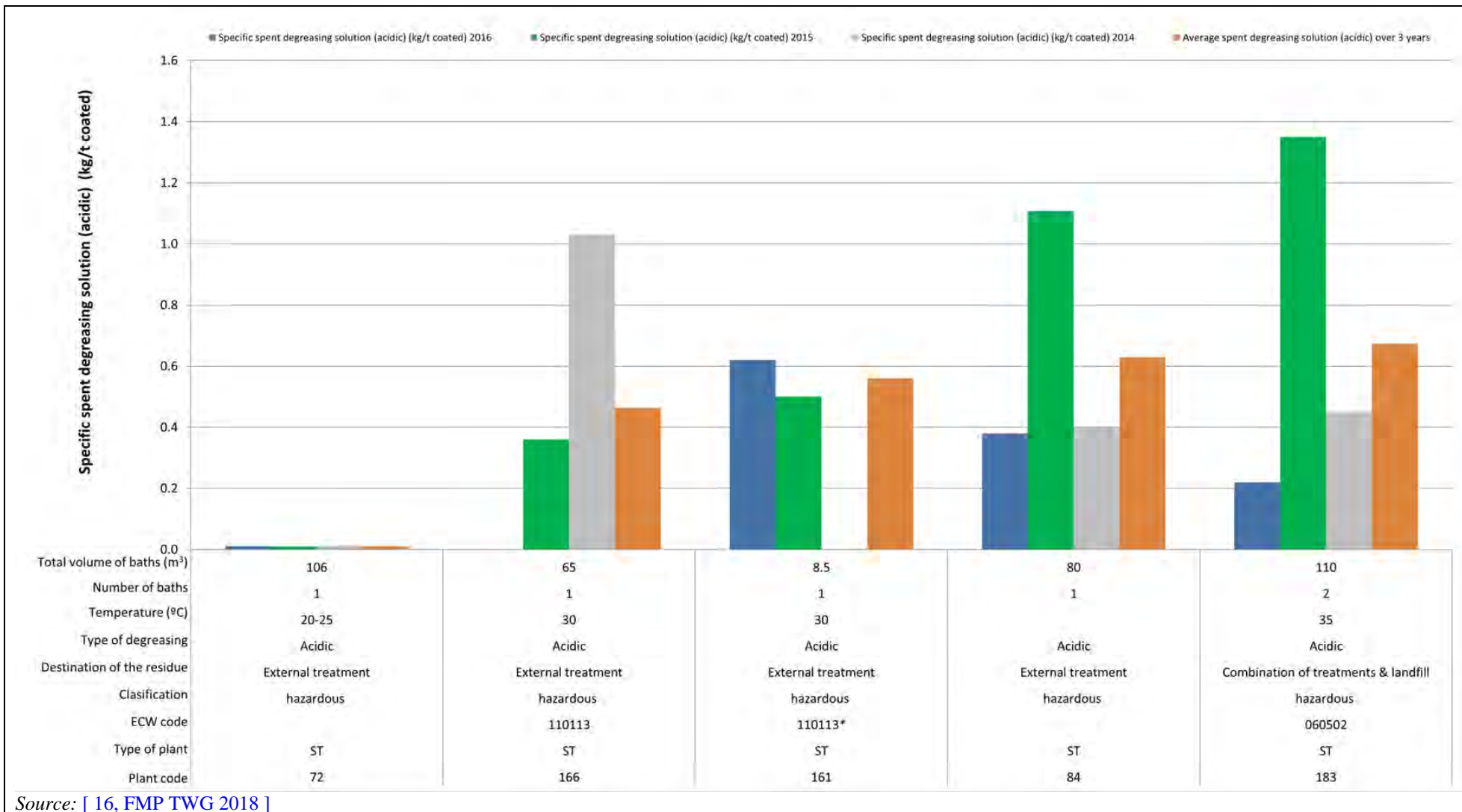


Figure 6.17: Specific generation of spent alkaline degreasing solution (in kg/t)



Source: [16, FMP TWG 2018]

Figure 6.18: Specific generation of spent acidic degreasing solution (in kg/t)

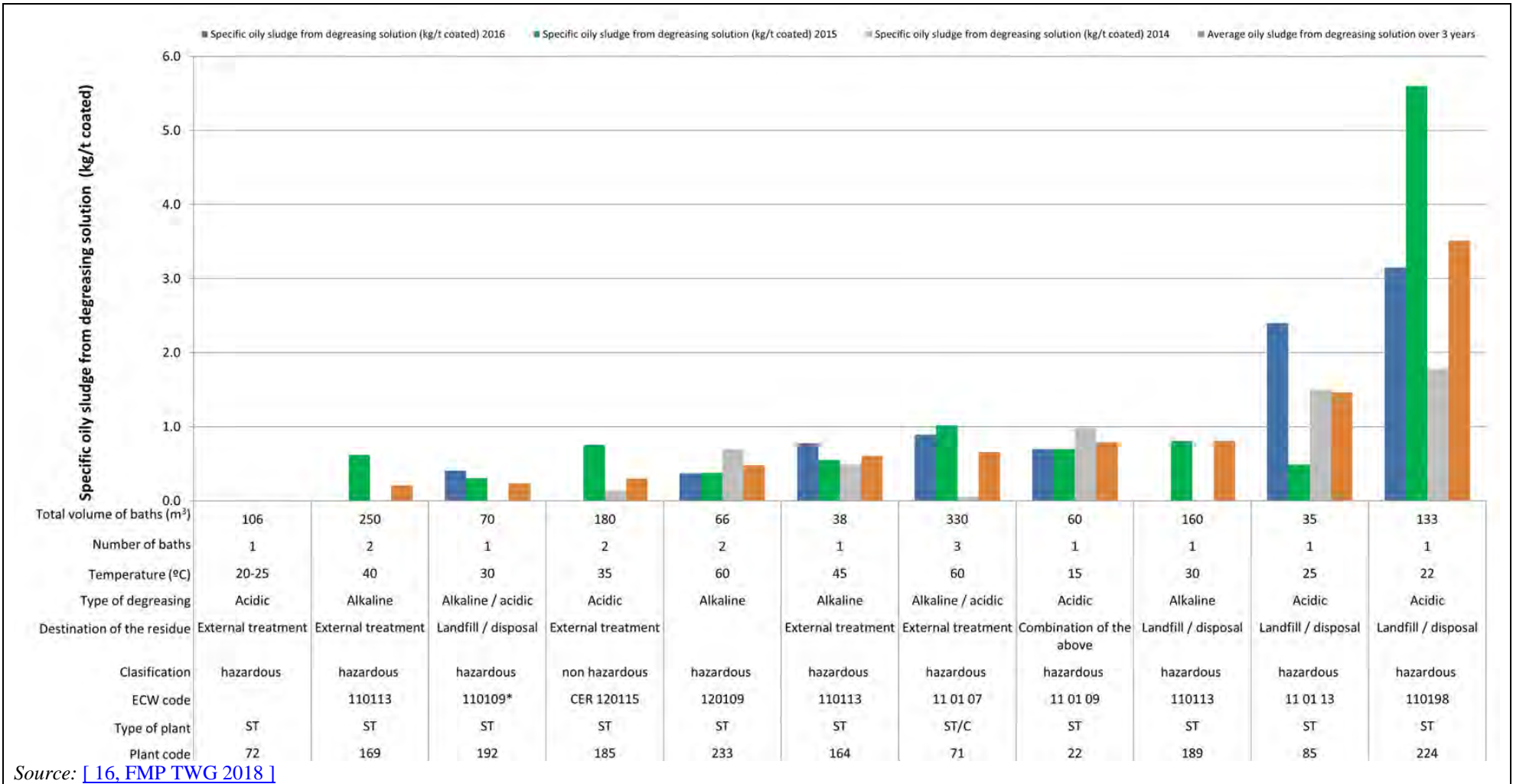
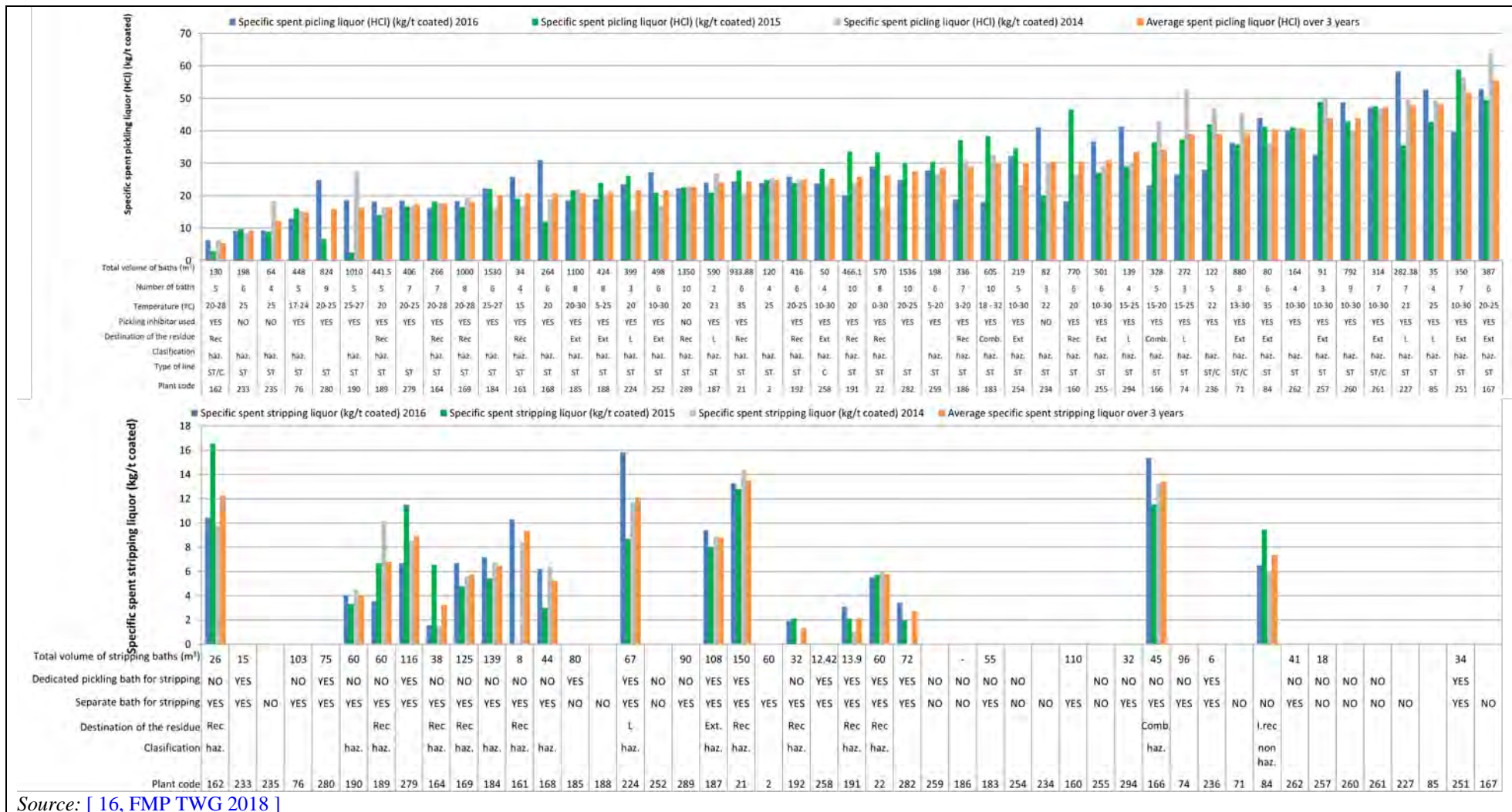
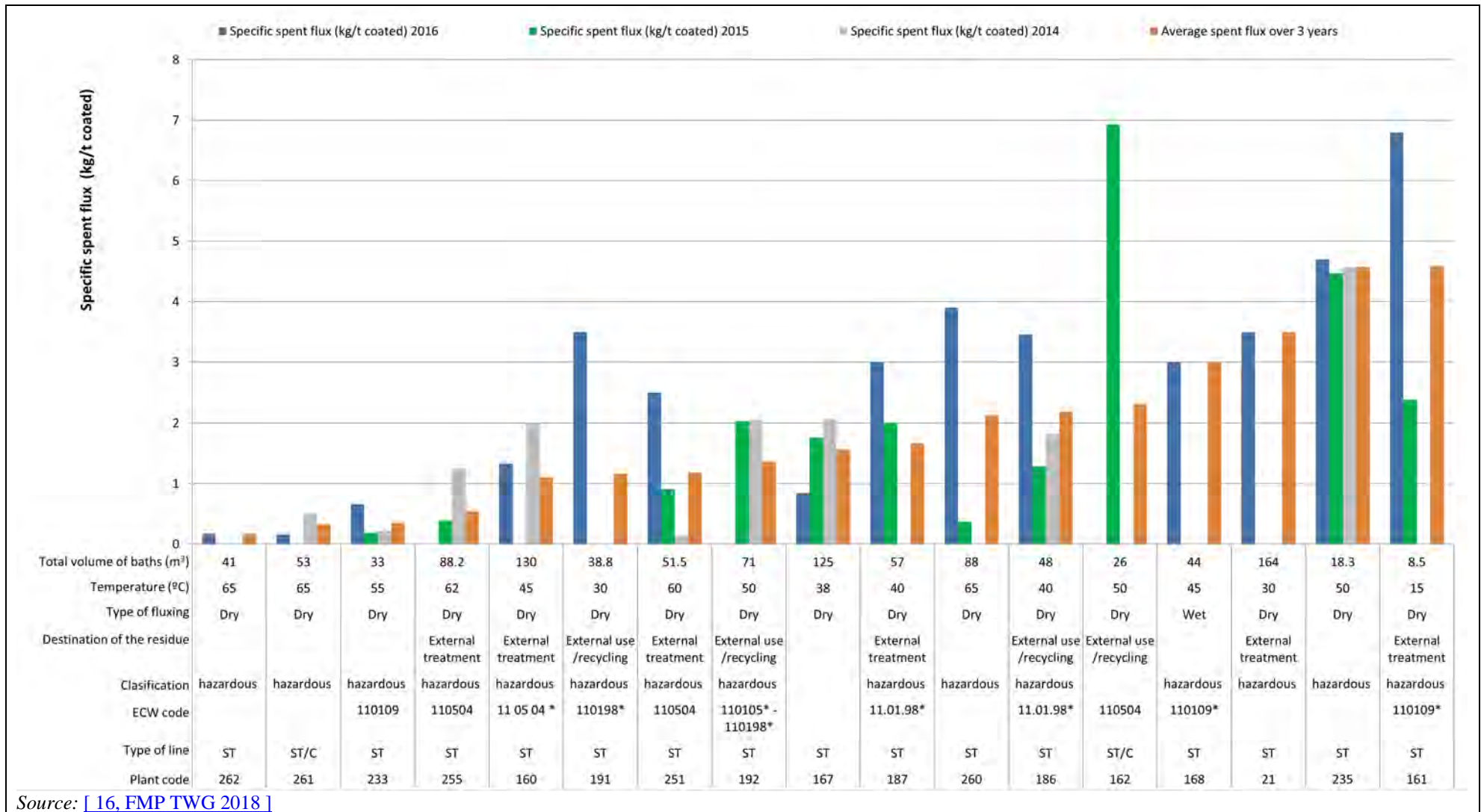


Figure 6.19: Specific generation of oily sludge from degreasing solution (in kg/t)



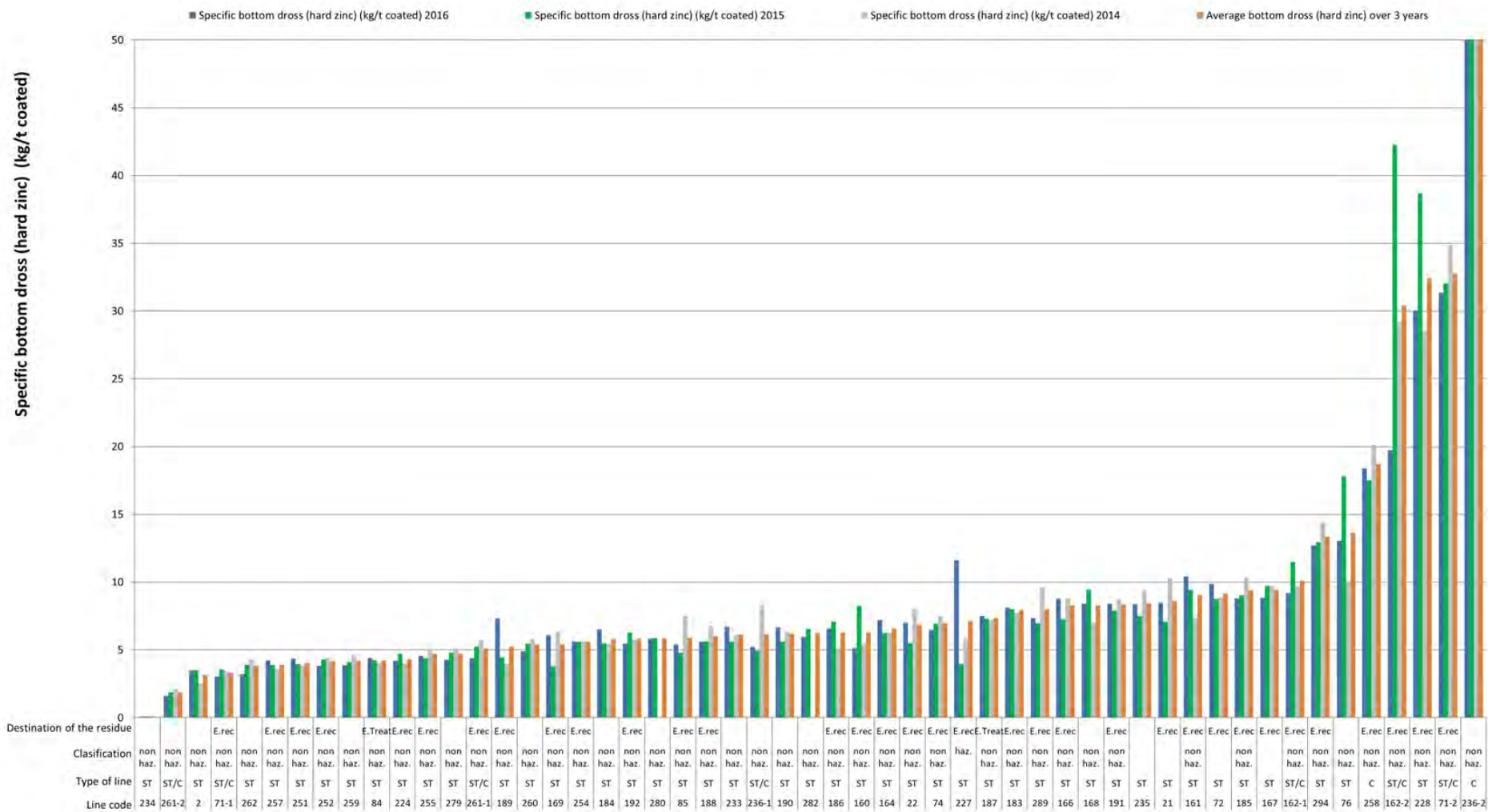
Source: [16, FMP TWG 2018]

Figure 6.20: Specific generation of spent HCl from pickling and stripping (in kg/t)



Source: [16, FMP TWG 2018]

Figure 6.21: Specific generation of spent flux (in kg/t)



Note: Line 236-2 is a specialist centrifuge line for galvanising of nails.

Source: [16, FMP TWG 2018]

Figure 6.22: Specific generation of bottom dross (in kg/t)

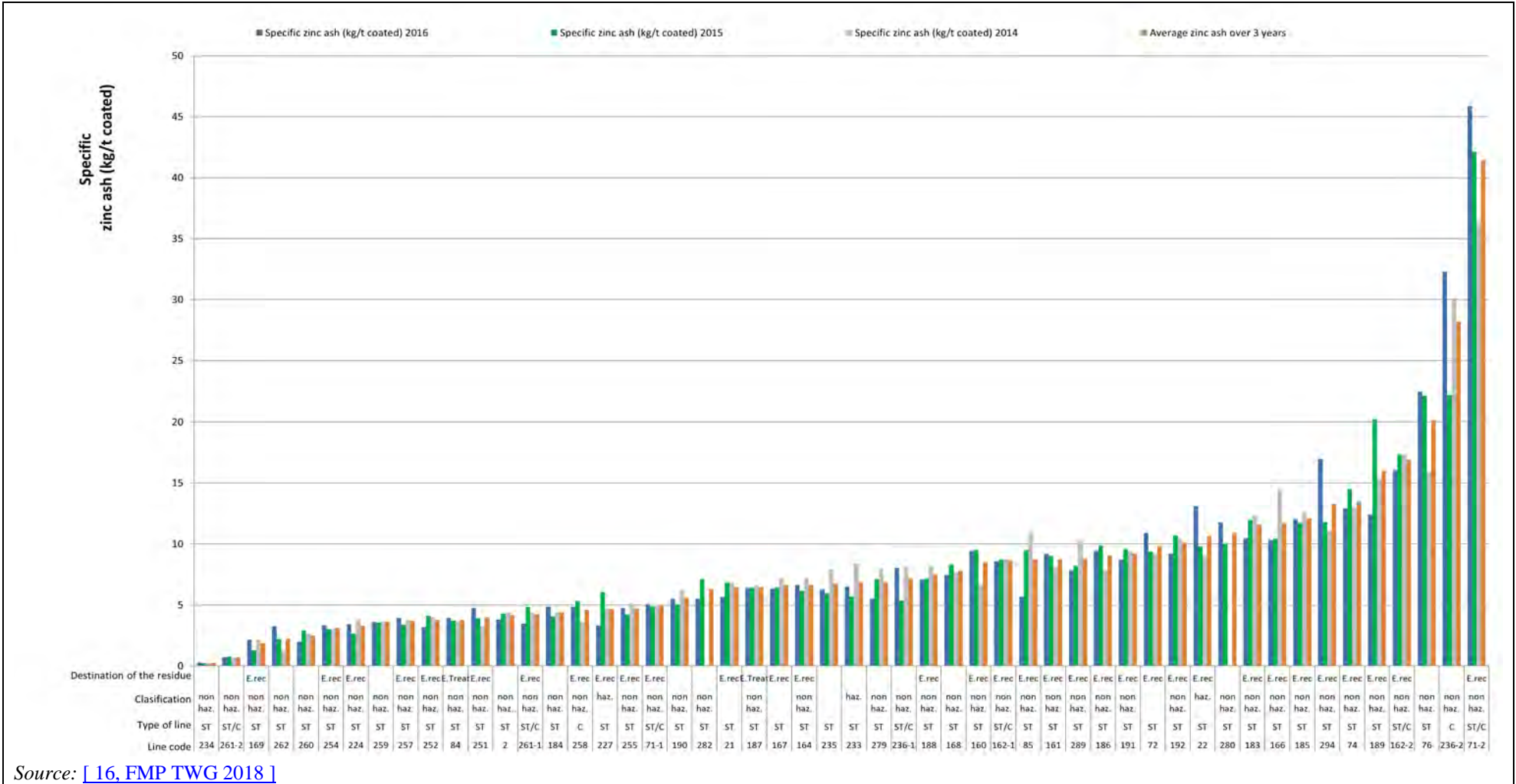


Figure 6.23: Specific generation of zinc ash (in kg/t)

6.4 Techniques to consider in the determination of BAT for batch galvanising

This section describes techniques (or combinations thereof), and associated monitoring, considered to have the potential for achieving a high level of environmental protection in the activities within the scope of this document. The techniques described will include both the technology used and the way in which the installations are designed, built, maintained, operated and decommissioned.

It covers environmental management systems as well as process-integrated and end-of-pipe techniques. Waste prevention and management, including waste minimisation and recycling procedures, are also considered, as well as techniques that reduce the consumption of raw materials, water and energy by optimising use and reuse. The techniques described also cover the prevention or limiting of the environmental consequences of accidents and incidents. They also cover the prevention or reduction of emissions under other than normal operating conditions (such as start-up and shutdown operations, leaks, malfunctions, momentary stoppages and the definitive cessation of operations).

Annex III to the Directive lists a number of criteria for determining BAT, and the information within this chapter will address these considerations. As far as possible, the standard structure in Table 2.15 is used to outline the information on each technique, to enable a comparison of techniques and the assessment against the definition of BAT in the Directive.

This chapter does not necessarily provide an exhaustive list of techniques that could be applied in the sector. Other techniques may exist, or may be developed, which could be considered in the determination of BAT for an individual installation.

In Chapter 8 general techniques (i.e. those used that are commonly used) are discussed which might also be applicable to batch galvanising. These techniques are normally not repeated in this section, unless information specific for this sector was made available.

6.4.1 Degreasing

6.4.1.1 Slow lifting of workpieces

Description

Workpieces are lifted slowly from the degreasing solution to allow for a sufficient dripping time.

Technical description

Slow lifting of workpieces and sufficient time to allow drainage of solutions minimises losses during transfer between tanks and carry-over to subsequent tanks.

Achieved environmental benefits

Increased material efficiency.

Environmental performance and operational data

No information provided.

Cross-media effects

None reported.

Technical considerations relevant to applicability

Generally applicable.

Economics

No information provided.

Driving force for implementation

Reduced costs due to increased material efficiency.

Example plants

Widely used.

Reference literature

No reference literature provided.

6.4.1.2 Biological treatment of the degreasing bath ('biological degreasing')

Description

Oil and grease in the degreasing baths are decomposed by microorganisms. The resulting biological sludge is drained out of the system daily.

Technical description

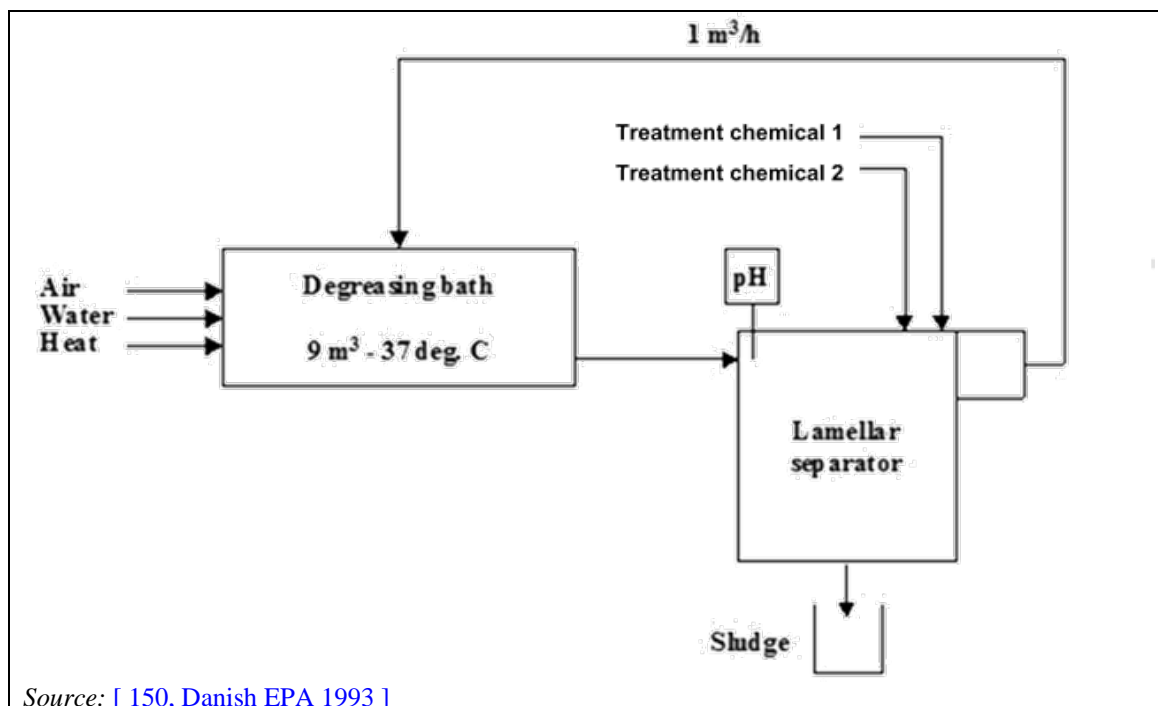
The degreasing solution is based on alkali, phosphates, silicates as well as nonionic and cationic tensides. A concentrate of these chemicals and microorganisms is mixed continuously. In the degreasing tank itself, air is admitted to keep the biological processes ongoing. Water is also added to compensate for the evaporation loss, as the bath is kept at the optimum operating temperature of 37 °C. The liquid from the degreaser tank is circulated across a lamellar separator at a rate of approximately 1 m³/h. In the lamellar separator, the accumulated sludge is separated. The sludge (approximately 10 l/d) is drained off manually via a bottom valve. The dosing of chemicals is performed by dosing pumps in the outlet box downstream of the lamellar separator. It may be difficult to be totally accurate, and excess consumption will probably be common. The dosing of required chemicals is automatically controlled to maintain a pH value of 9.13. [150, Danish EPA 1993]

Achieved environmental benefits

- Increased material efficiency.
- Reduced waste water and sludge.

Environmental performance and operational data**Example Næstved Varmforzinkning**

Næstved Varmforzinkning introduced the process in 1987 and the operational experience is very positive (see Figure 6.24). Compared to degreasing with warm caustic soda, the degreasing is much more efficient and consistent, resulting in quicker pickling with less acid attack on the base material. Both the consumption of pickling acid and of discarded waste have dropped. After pickling, the surface is more even and uniform than before. This has in turn resulted in lower consumption of zinc in the hot-dip galvanising process itself. In practice, the consumption of chemicals has been about six times higher than expected (per tonne of products per year). This is probably due to both overdosing and a necessary additional consumption for the heavily oiled items processed at the plant. Furthermore, the items have a very large surface per unit weight which requires more chemicals per tonne of products. The system is probably 3–6 times bigger than necessary for Næstved Varmgalvanisering. The company simply bought the smallest system for biological degreasing sold by the provider. [150, Danish EPA 1993]



Source: [150, Danish EPA 1993]

Figure 6.24: Flowsheet for biological degreasing

Example galvanising plant, Germany [155, P. Kunz 1996]

The galvanising plant switched operation from acidic degreasing to biological degreasing in the period of December 1994 to April 1995. The initial production line included an acidic degreasing bath, consisting of diluted phosphoric acid and HCl, tensides and corrosion inhibitors, followed by a rinse. The bath quality was maintained by removing the oil from the surface and refreshing the acidic bath liquor. The acidic degreasing was changed to alkaline degreasing followed by a biological rinse bath treatment. Reported advantages of the switch of operation were:

- reduced pickling time (20–25 %);
- increased pickling quality;
- reduced fresh acid consumption;
- reduced rejects;
- reduced oily sludge.

Cross-media effects

Higher energy consumption to heat the degreasing bath.

Technical considerations relevant to applicability

Generally, there are no technical restrictions to the applicability of this technique.

Economics

It is difficult to quantify the financial advantages of the plant compared to degreasing in warm caustic soda lye. The consumption of acid and zinc have dropped considerably and fewer products are scrapped. However, the savings are also caused by other changes in products and production during the period in question. It is therefore difficult to decide exactly what financial advantages the new degreasing process is offering. [150, Danish EPA 1993]

Driving force for implementation

- Reduced costs due to increased material efficiency.
- Reduced waste water and sludge.
- Accelerated and improved pickling.

Example plants

Næstved Varmforzinkning ApS (period of experience: 6 years); [150, Danish EPA 1993]
France; Verzinkerei Dieren, NL.
Voigt & Schweitzer Henssler GmbH & Co. KG (Plant 49). [16, FMP TWG 2018]

Reference literature

[16, FMP TWG 2018], [150, Danish EPA 1993], [155, P. Kunz 1996]

6.4.2 Pickling and stripping**6.4.2.1 Separate pickling and stripping****Description**

Pickling and stripping are carried out in separate tanks in order to prevent the generation of spent acids with high zinc and high iron concentrations or to reduce their quantity sent for disposal.

Technical description

In general, spent acids containing large amounts of both iron and zinc are very difficult to reuse or recycle. By pickling and stripping in separate tanks, the zinc content in the pickling acid can be kept low. [144, ABAG 1993]

Achieved environmental benefits

Easier recycling of spent pickling acid.

Environmental performance and operational data

No information provided.

Cross-media effects

None.

Technical considerations relevant to applicability

Applicability to existing plants may be restricted by a lack of space in the event that additional tanks for stripping are needed.

Economics

No information provided.

Driving force for implementation

Reduced costs due to increased material efficiency.

Example plants

BG plants from data collection, plant codes: 1, 2, 3, 4, 5, 6, 7, 20, 21, 22, 23, 48, 49, 50, 51, 52, 53, 54, 57, 58, 61, 62, 63, 64, 72, 74, 75-1, 75-2, 76, 160, 161, 162-1, 163, 164, 165, 166, 168-1, 168-2, 169, 183, 184, 187, 189, 190, 191-1, 192, 198, 224, 226-2, 233, 236-1, 251, 258, 262, 276-1, 277, 279, 280, 281-1, 282, 283, 284, 285, 289, 293, 294, 295-1.

Reference literature

[80, DE, TWG member 2000], [144, ABAG 1993]

6.4.2.2 Evaporative recovery (HCl)

Description

See Section 8.6.5.

Technical description

See Section 8.6.5.

Achieved environmental benefits

See Section 8.6.5.

Environmental performance and operational data

Figure 6.25 and Figure 6.26 show the flowsheet and the mass balance for an example galvanising plant.

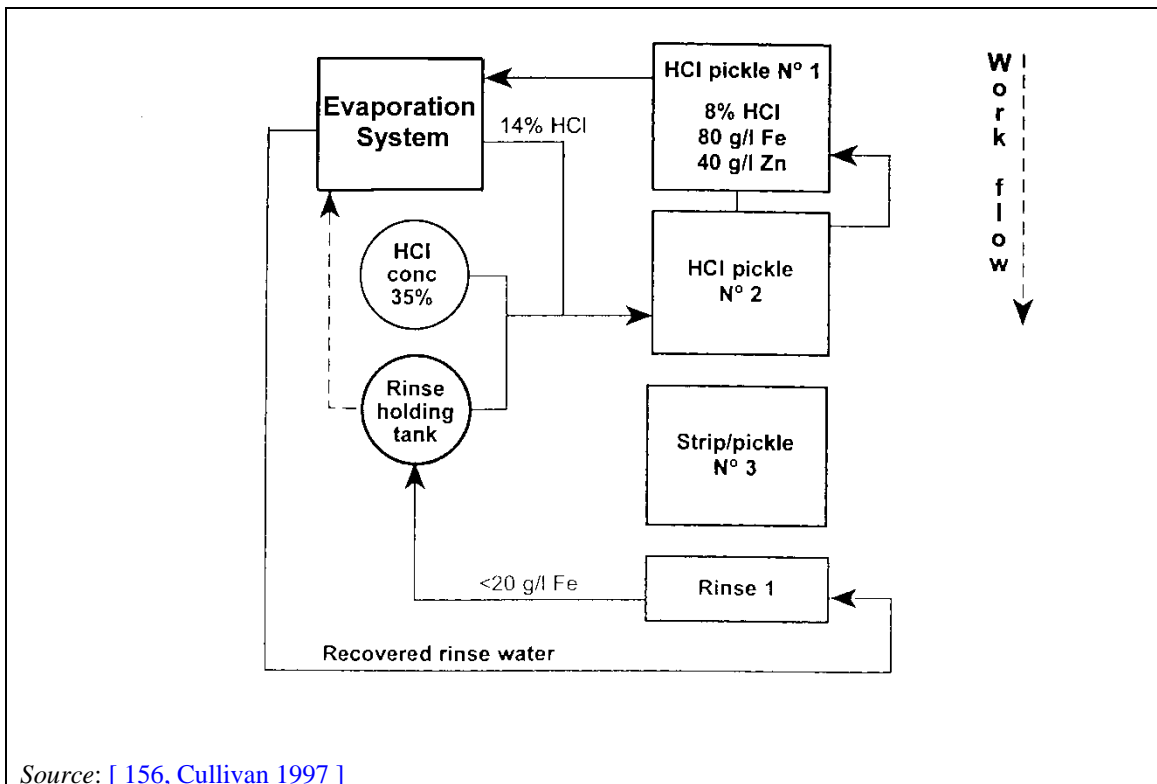


Figure 6.25: Example flowsheet for evaporative HCl recovery

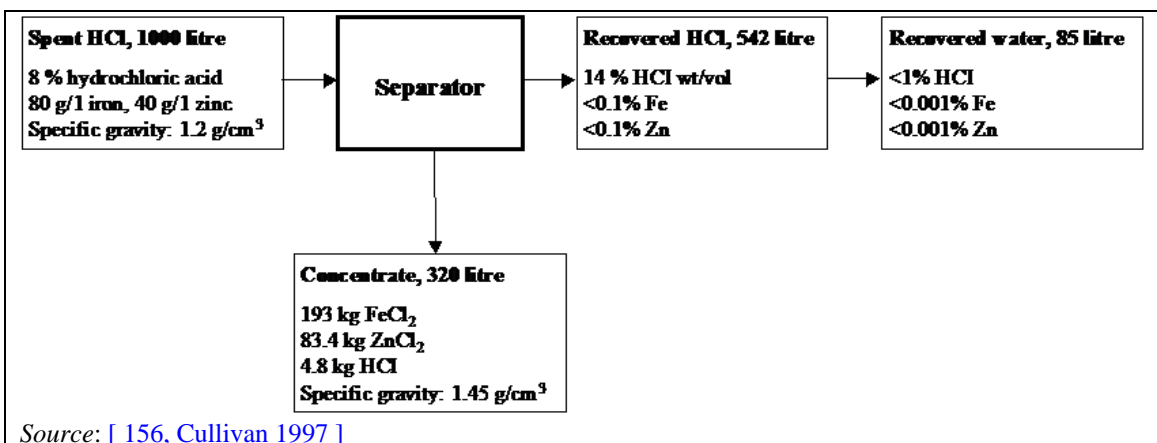


Figure 6.26: Example mass balance for evaporative HCl recovery

The recovered acid can be returned to the pickling tank. Additional fresh acid blended into the pickling tank will make up for volume losses generated by the removal of the iron chloride solution and water. The recovered water can proceed either to the rinse tank, to the pickle tanks or to the flux bath. [156, Cullivan 1997]

The energy consumption for the plant as a whole is 230 kWh/m³ treated, with a net energy recovery of 150 kW by using a special heat exchanger. [146, EGGA 2000]

Cross-media effects

- High energy consumption [80, DE, TWG member 2000].
- Generation of a concentrated iron chloride solution (concentrate) that may not be suitable for recycling.

Technical considerations relevant to applicability

See Section 8.6.5.

Economics

No information provided.

Driving force for implementation

See Section 8.6.5.

Example plants

BG plans from the data collection, plant codes: 61, 62, 295, 296.

Reference literature

[16, FMP TWG 2018], [80, DE, TWG member 2000], [146, EGGA 2000], [156, Cullivan 1997]

6.4.2.3 Zinc removal by ion exchange

Description

The treated acid can be used in pickling, while the ZnCl₂- and NH₄Cl-containing solution resulting from the stripping of the ion-exchange resin can be used for fluxing.

Technical description

The process (see Figure 6.27) is divided into four stages, namely:

- zinc removal;
- rinsing I (elution 1);
- stripping and regenerating;
- rinsing II.

This may take place on site or off site.

Pickling acid is pumped out of the bath through a plate filter to remove any solid particles. The clear liquid then flows through the column. In the column, zinc is removed from the pickling acid and bound to the ion-exchange material. After leaving the column, the zinc-free liquid is pumped back into the pickling bath. Thus the system recycles the acid. However, the acid does not necessarily have to be recirculated and can be processed and then stored in a vessel (once-through process) or pumped out into another vessel, run through the column and stored in a third tank (batch process).

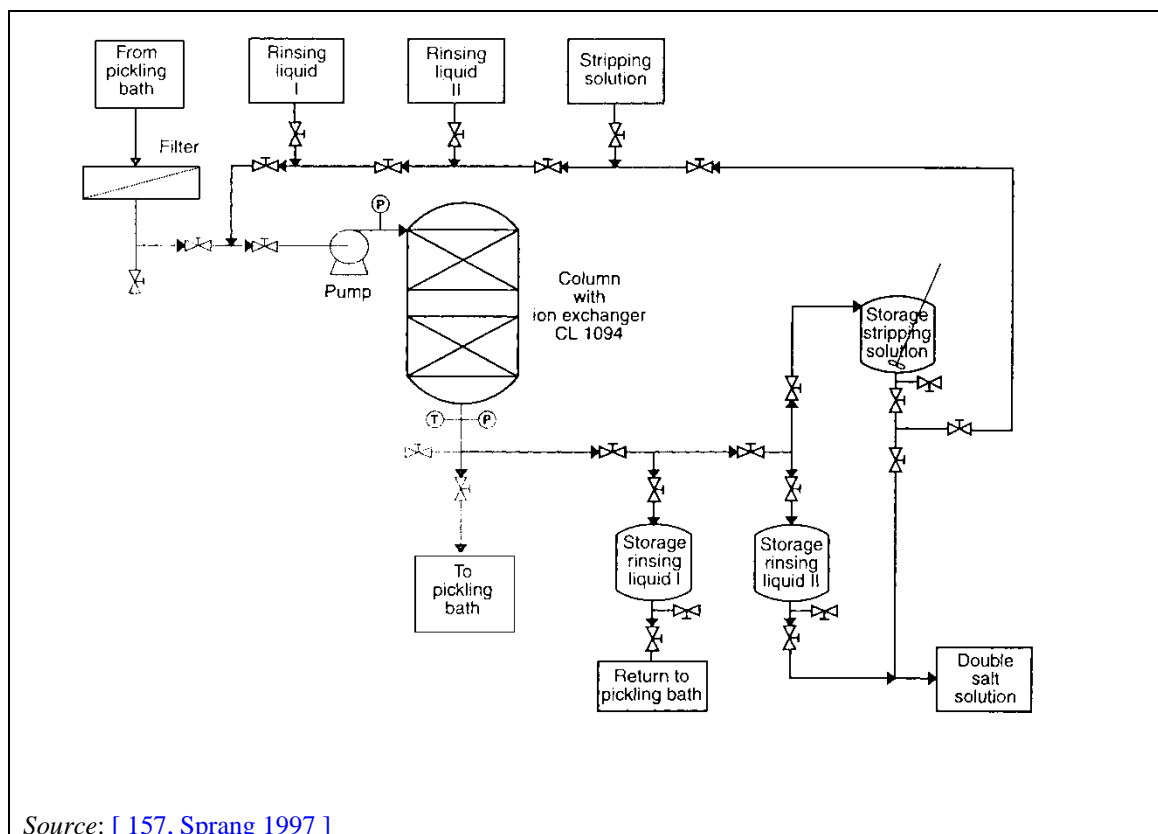


Figure 6.27: Flow chart for removal of zinc from pickling baths

In the second stage, after the ion-exchange material becomes saturated with zinc, the column has to be washed to remove the pickling acid. The solution thus obtained is an HCl solution that can be used to modify the strength of the pickling bath. In the third stage, the ion-exchange material is stripped with an alkaline solution in order to remove the zinc. If second-stage rinsing does not take place, iron hydroxide is precipitated, interfering with the process. The stripping solution is used several times before it becomes concentrated. When the stripping solution has reached saturation it can be used to modify the composition of the flux bath. The stripping solution contains only $ZnCl_2$ and NH_4Cl . After the ion-exchange material has been stripped and regenerated, the last remains of the solution must be removed. This is done in the fourth stage by rinsing with tap water. Otherwise, the pickling acid would be contaminated with NH_4^+ . It is important to distinguish between the stripping solution within Figure 6.27 which arise during the recovery process and the spent stripping solution that arise within the galvanising process itself.

Achieved environmental benefits

- Increased material efficiency.
- Reduction of acid sent for disposal.

Environmental performance and operational data

No information provided.

Cross-media effects

Increased consumption of chemicals.

Technical considerations relevant to applicability

Generally, there are no technical restrictions to the applicability of this technique.

Economics

This technique requires considerable capital and running costs and that scales of economy are a critical factor which may not be achievable by many galvanising plants with typical sizes. [140, UK Galvanisers 2000]

Driving force for implementation

Reduced costs due to increased material efficiency.

Example plants

BG plant from the data collection, plant code: 165.

Reference literature

[16, FMP TWG 2018], [140, UK Galvanisers 2000]

6.4.2.4 Iron removal by oxidation and precipitation**Description**

The resulting liquid can be used for fluxing.

Technical description

Spent hydrochloric acid from combined pickling and stripping with high concentrations of iron and zinc can be processed and recovered as a flux bath.

See Section 8.6.3.3.

Achieved environmental benefits

- Increased material efficiency.
- Reduction of acid sent for disposal.

Environmental performance and operational data

No information provided.

Cross-media effects

Increased consumption of chemicals.

Technical considerations relevant to applicability

Generally, there are no technical restrictions to the applicability of this technique.

Economics

No information provided.

Driving force for implementation

Reduced costs due to increased material efficiency.

Example plants

No information provided.

Reference literature

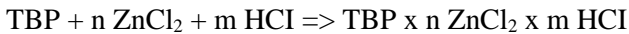
[145, DK, TWG member 1999]

6.4.2.5 Zinc removal by solvent extraction**Description**

The treated acid can be used in pickling, while the zinc-containing concentrate resulting from stripping and evaporation can be used for other purposes.

Technical description

The solvent extraction process for selective zinc removal from spent HCl pickling acids uses the extractant tributylphosphate (TBP). It may be carried out on site or off site and is based on the following simplified reaction:



ZnCl₂ and HCl from the aqueous feed form a complex in the organic phase, which is less dense than the aqueous phase. Thus, the two phases can be separated by decantation. When the loaded organic phase is intensively contacted with a fresh aqueous phase, the complexing reaction is reversed (re-extraction) so the stripped organic extractant can be recycled and a dilute aqueous ZnCl₂ solution is produced. The ZnCl₂ solution is evaporated to increase the zinc concentration. The condensate from evaporation is recycled to re-extraction and the concentrate is sold. Figure 6.28 illustrates the whole process schematically. It is important to distinguish between the strip solution produced from the zinc stripping step within Figure 6.28 which arise during the solvent extraction process and the spent stripping solution that arise within the galvanising process itself.

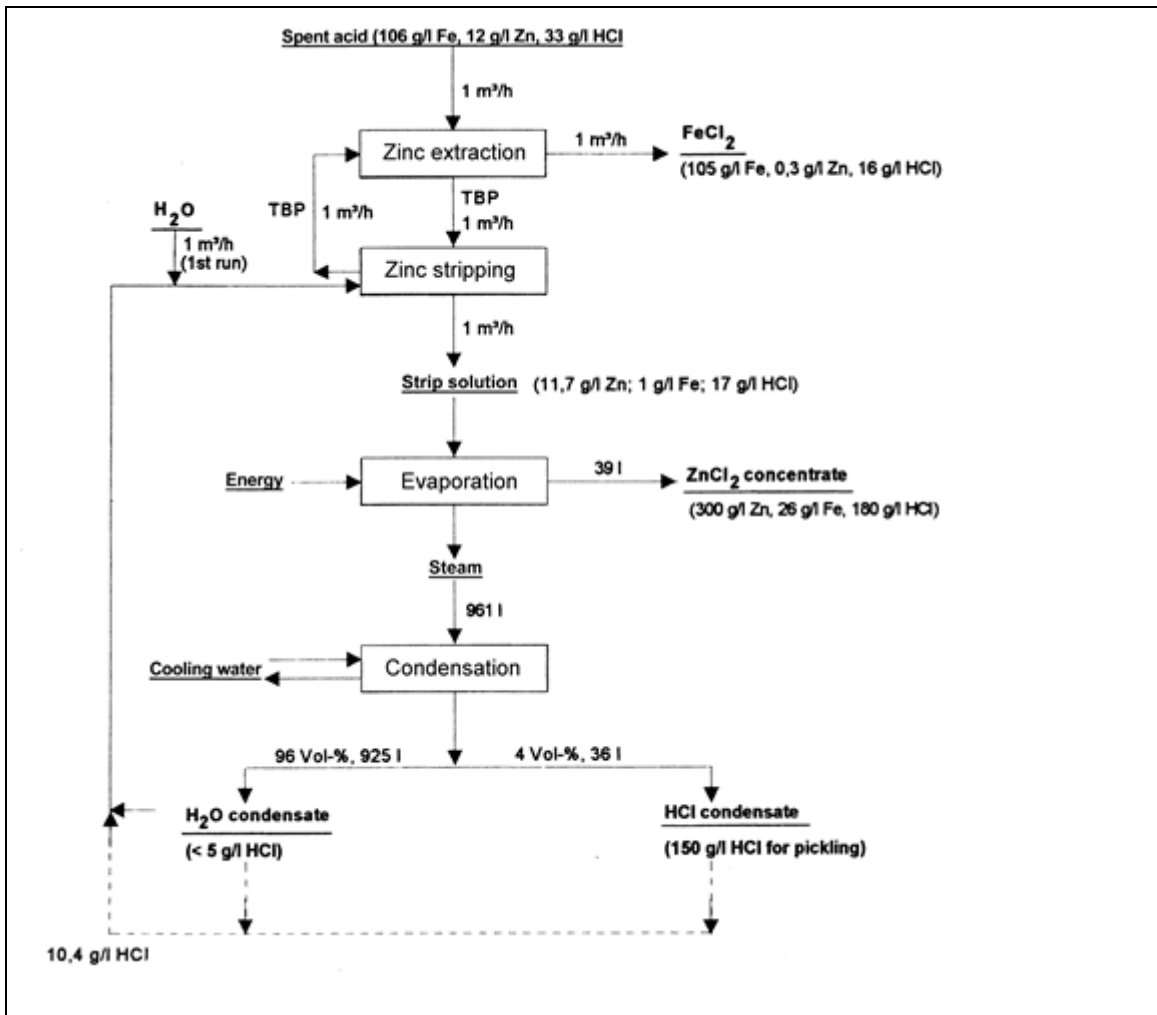


Figure 6.28: Schematic of the solvent extraction process

Spent acid, stored in a special tank or in the pickling vessel, passes through a filter in which solid particles such as metal swarf, oxide scale, insoluble oils, dirt and cigarette ends etc. are captured. The filtrate passes a buffering device and enters the first of three conventional mixer-settlers for zinc extraction by TBP. Zinc is extracted together with some free HCl and FeCl₃.

The zinc-loaded organic phase leaves the extraction section after three countercurrent contacts with the spent acid. More or fewer stages are possible depending on the zinc concentration. The organic phase, which is less dense than the aqueous phase, leaves the settler over a weir which adjusts the phase boundary and organic to aqueous volume ratio.

The zinc-free FeCl_2 raffinate leaves the last mixer-settler (third extraction stage) from the bottom and is captured by a coalescer to remove any residual organic phase. The raffinate is pumped to the storage vessel of the plant, which may be a fixed tank or a tank truck. The zinc-loaded organic phase enters the re-extraction section (same container) consisting of three further mixer-settlers. Here it comes into contact with normal tap water and condensate from the evaporation unit. ZnCl_2 , FeCl_3 traces and HCl are washed from the extractant, which is recycled to the extraction vessel. The aqueous solution (strip solution) again passes a coalescer and is pumped to the evaporation container.

The strip solution shows a very low zinc concentration and normally has no further direct use. For that reason, it is concentrated to about 300 g zinc per litre. Any other suitable concentration can be achieved.

Evaporation is carried out by a steam-heated evaporator.

The zinc concentration in the pregnant liquor is of minor interest for the extraction process. Ideally, the strip solution will contain about 30 g/l zinc. The lower the zinc concentrations in the spent acid, the higher the nominal throughput of acid will be due to a higher aqueous/organic ratio. However, higher zinc feed leads to higher treatment costs.

The vapour passes a condenser cooled by salt-free tapwater in a circuit. In this way it is possible to completely recover the evaporated water and HCl with a cooling tower.

Vapour condensation can be arranged in two steps. First, the water with low free HCl (< 5 g/l in total volume) will be captured. This fraction is about 85–95 % of the total condensate. Then the tank is changed and filled with the remaining condensate, rich in acid. A final concentration of 15–18 %, suitable for pickling, should be achievable. The acid can be reused in-house. Due to technical problems, this selective HCl recovery was not possible within the project period.

Evaporation can be carried out more or less continuously. It is complete when the zinc concentration in the evaporator feed reaches 300 g/l. The final concentration can vary depending on the customer's requirement.

Achieved environmental benefits

- Increased material efficiency.
- Reduction of acid sent for disposal.

Environmental performance and operational data

Some operational data are given in Figure 6.28.

Cross-media effects

- Increased consumption of chemicals.
- Increased energy consumption.

Technical considerations relevant to applicability

Generally, there are no technical restrictions to the applicability of this technique.

Economics

No information provided.

Driving force for implementation

Reduced costs due to increased material efficiency.

Example plants

A liquid-liquid extraction plant for the recovery of acids containing zinc and iron is operated by Norsk Hydro at Oberhausen, Germany.

Trials and investigations were done with a mobile unit at the Berliner Grossverzinkerer/Metaleurop. Meanwhile the mobile unit has been turned into a stationary plant. [80, DE, TWG member 2000]

Reference literature

[80, DE, TWG member 2000]

6.4.2.6 Restricted operating range for hydrochloric acid open pickling baths

Description

Hydrochloric acid baths are strictly operated within the temperature and HCl concentration range determined by the following conditions:

- a) $4\text{ °C} < T < (80 - 4w)\text{ °C}$;
- b) $2\text{ wt-%} < w < (20 - T/4)\text{ wt-%}$,

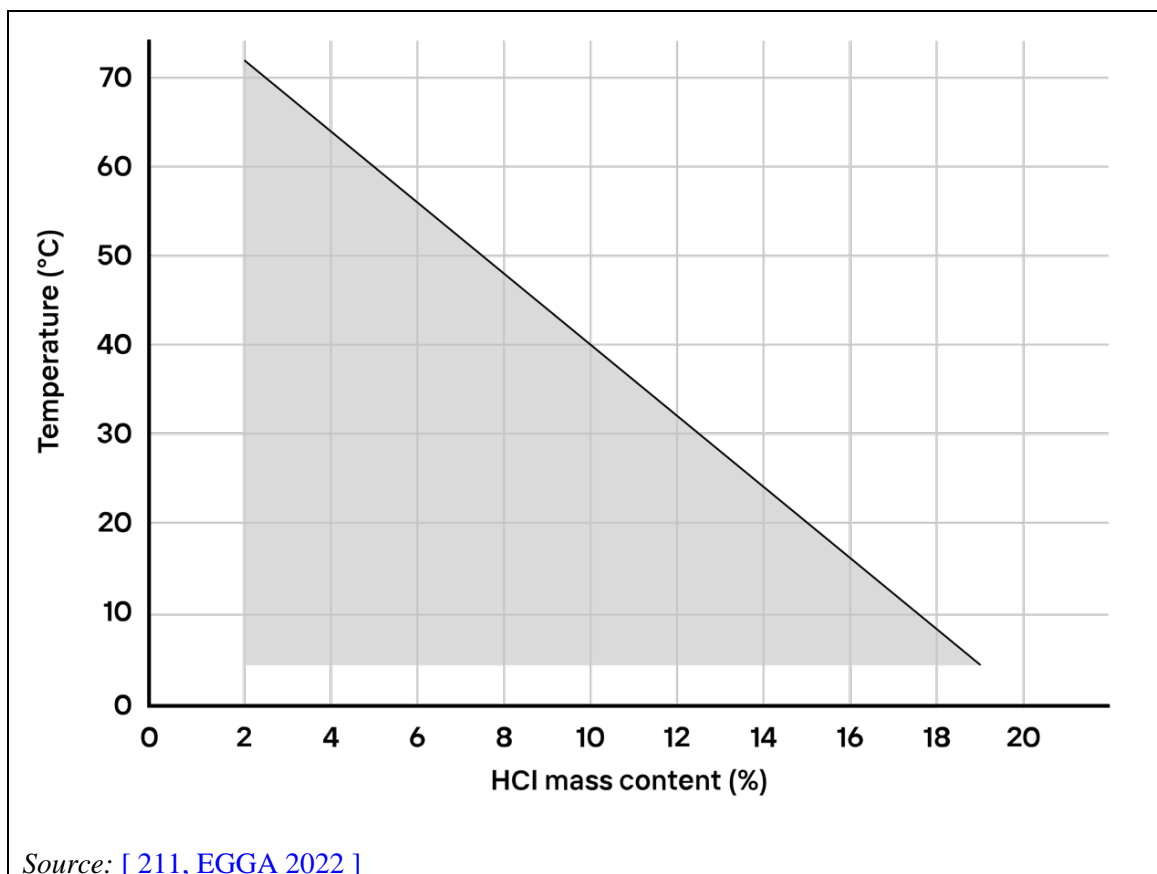
where T is the pickling acid temperature expressed in °C and w the HCl concentration expressed in wt-%. The bath temperature is measured at least once every day. The HCl concentration in the bath is measured every time fresh acid is replenished and in any case at least once every week. To limit evaporation, movement of air across the bath surfaces (e.g. due to ventilation) is minimised.

Technical description

Emissions of acid fumes to air are limited by keeping the temperature and the concentration of the acid bath within a defined range. For any given acid concentration a maximum allowed bath temperature and for any acid bath temperature a maximum allowed acid concentration are defined by the thermodynamic equilibrium and the vapour pressure of the acid.

The hydrogen chloride content in the gaseous phase above a hydrochloric acid pickling bath depends to a large degree on bath temperature and concentration and is determined by thermodynamic equilibrium and the vapour pressure of the acid.

Figure 6.29 shows an extended version of the limiting curve for the operation of open HCl pickling baths presented originally in the VDI 2008. [147, VDI 2008]. Compared to the original curve presented in the VDI 2008, this extended version covers plants operating at temperatures of 4°C. [211, EGGA 2022]



Source: [211, EGGA 2022]

Figure 6.29: Limiting curve for the operation of open HCl pickling baths

The equation given in the description corresponds to the shaded area of the diagram.

Achieved environmental benefits

Reduction of acid emissions to air.

Environmental performance and operational data

Emissions from pickling baths are – according to VDI guideline 2579 – considered below 10 mg/m^3 when the operating point (temperature and HCl concentration) of the baths is within the shaded area of this diagram. [147, VDI 2008], [211, EGGA 2022]

By close control of process parameters (temperature, concentration) and by ensuring that bath operating conditions are within these given limits, vapour extraction systems and subsequent abatement techniques may become redundant.

No information was provided on the monitoring practices for the acid bath parameters: temperature and acid concentration (i.e. measuring methods/standards, frequency of monitoring), or on the corrective actions applied if the pickling bath parameters are outside the the range described under description (provisions a) and b)).

During operation the ferrous chloride concentration in the pickling baths rises. This results in an increased pickle effect. At the same time, ferrous chloride in hydrochloric acid affects the vapour pressure of the acid in the same way as if the acid concentration was increased: the vapour pressure is increased. Comparing a pickle liquor with 1 % HCl and 6 % iron at $140 \text{ }^\circ\text{F}$ ($60 \text{ }^\circ\text{C}$) with a straight 10 % acid solution, the vapour pressure is increased five times. [158, Stone 1997]

So, in determining the optimum operating range with respect to emission reduction, the ferrous chloride content should be taken into account.

Another aspect influencing the amount of acid vapour emitted is the air flow rate over the pickling bath. Assuming an absolutely still atmosphere over the bath, the evaporation of acid would come to a halt as the equilibrium, determined by the vapour pressure, is reached. A more or less strong and constant air flow over the pickling tank sweeps away the acid vapour and keeps the evaporation process going. The result is not only increased acid consumption, but also higher acid emissions. Air movement and, in the case of extraction systems, the extraction rate should be kept as low as possible.

Cross-media effects

The acid concentration chosen according to the VDI guideline is lower than typically used in the case of wire rod pickling. This results in the following:

- Lower conversion of the acid from HCl to FeCl₂, which implies a higher consumption of fresh HCl. [\[119, Gielen 2000 \]](#)
- Reuse of spent acid as secondary raw material becomes very difficult. For reuse for the production of FeCl₃, a minimum concentration of 10 % Fe is requested; this high Fe concentration can only be achieved with a high conversion of HCl and with a high initial concentration of HCl. [\[119, Gielen 2000 \]](#)
- Increased pickling time, which implies investment in more and/or bigger pickling tanks. Increased bath surface leads to more g/h HCl evaporation. [\[119, Gielen 2000 \]](#)

Technical considerations relevant to applicability

Generally, there are no technical restrictions to the applicability of this technique.

Economics

No information provided.

Driving force for implementation

Minimising abatement costs.

Example plants

No information provided.

Reference literature

[96, Fundación Entorno 1999], [\[119, Gielen 2000 \]](#), [\[147, VDI 2008 \]](#), [\[158, Stone 1997 \]](#), [\[211, EGGA 2022 \]](#).

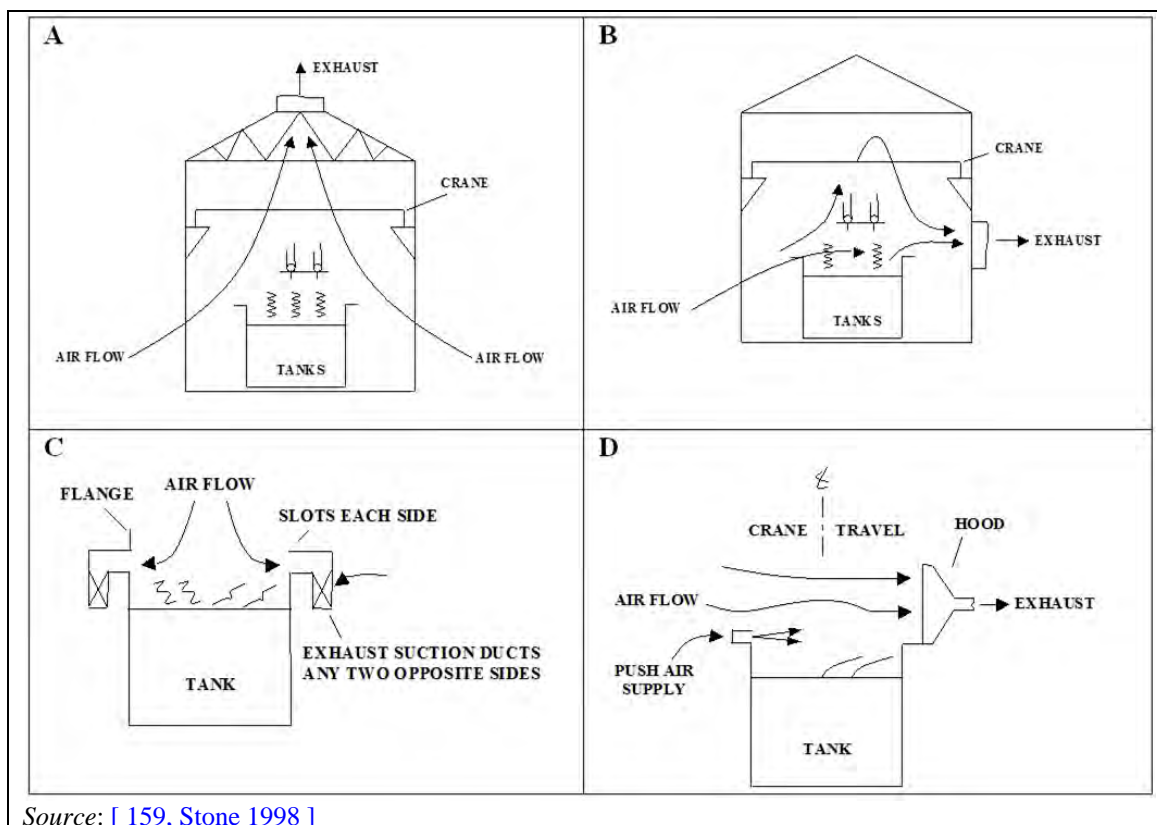
6.4.2.7 Extraction by lateral hood or lip extraction

Description

Acid fumes from the pickling tanks are extracted using lateral hoods or lip extraction at the edge of the pickling tanks. This may also include emissions from degreasing tanks. The collected emissions are treated by wet scrubbing followed by a demister (see Section 8.8.4.3).

Technical description

In order to extract emissions to air from pickling and/or other process baths, a variety of different designs and techniques are available. Figure 8.46 shows schematics for lip and lateral hood extraction systems in conventional open pickling tank operations.



Source: [159, Stone 1998]

Figure 6.30: Extraction systems (lip and lateral hoods) used in open pickling tank operations

Achieved environmental benefits

Reduction of dust, acids (HCl, HF, H₂SO₄) and SO₂ emissions.

Environmental performance and operational data information

Lip extraction and lateral hoods are designed to extract only emissions from the surrounding area of the pickling tank, thus the resulting volume flows are much smaller.

Batch galvanising plant (HCl pickling)

Table 6.5 summarises the HCl emissions of batch galvanising pickling plants from the FMP data collection equipped with air extraction as close as possible to the source and abatement. For these plants, the temperature of the acid bath ranged from 11°C to 35°C and the exhaust flow rate ranged from 30 Nm³/h to 210 200 Nm³/h.

Table 6.5: HCl emission concentrations from batch galvanising plants equipped with air extraction as close as possible to the source (lip and lateral hood extraction) and abatement (scrubber)

Substance	Concentrations reported over 3-year period - (mg/Nm ³)					Number of plants / number of measurements
	Average	Median	90 th percentile	Min.	Max.	
HCl	1.6	0.6	3.1	0.004	11.3	16 / 49

Source: [16, FMP TWG 2018]

Cross-media effects

None.

Technical considerations relevant to applicability

Applicability in existing plants may be restricted by a lack of space.

Economics

No information provided.

Driving force for implementation

Environmental legislation.

Example plants

BG plant from the data collection, plant code: 71, 75, 84, 103, 161, 162, 164, 166, 167, 168, 187, 189, 190, 191, 226, 285.

Reference literature

[158, Stone 1997].

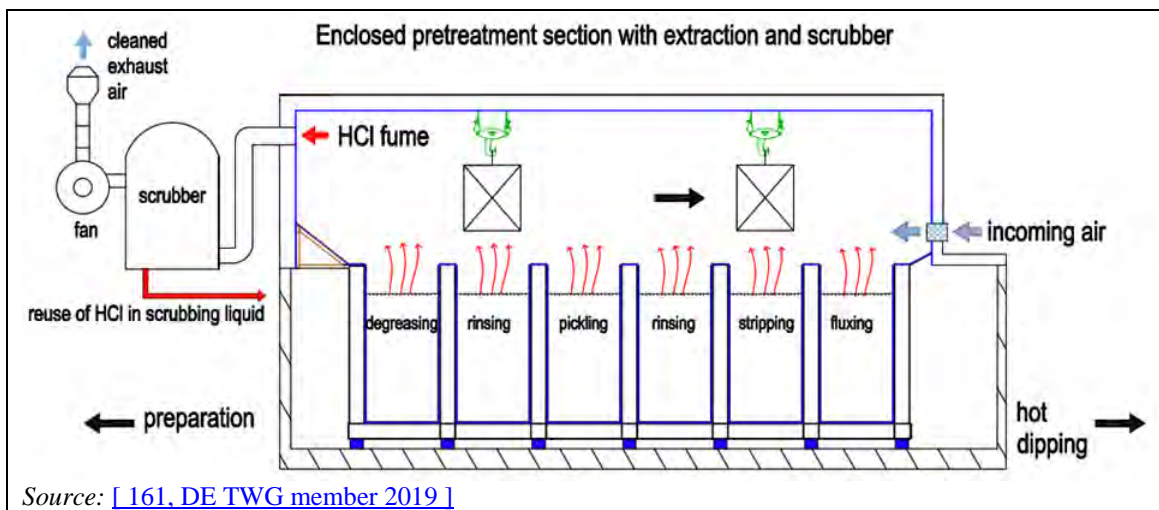
6.4.2.8 Enclosed pretreatment section with extraction

Description

The entire pretreatment section (e.g. degreasing, pickling, fluxing.) is encapsulated and the fumes are extracted from the enclosure.

Technical description

The entire pretreatment section (degreasing, pickling, fluxing) is encapsulated (see Figure 6.31 below).



Source: [161, DE TWG member 2019]

Figure 6.31: Schematic for an enclosed pretreatment section in batch galvanising

The enclosure is made of acid-resistant panels mounted on a steel or wooden sub-structure. To ensure the material flow, there are closable airlock access and exit gates. The cranes usually run outside the encapsulated area with ropes or chains entering through tightly sealed slots in the ceiling. Another possibility is to locate the cranes inside the enclosure. Operators stay outside the enclosed section and watch the process through the windows.

The tanks are connected and surrounded by acid-resistant floor panels in order to keep chemicals or aggressive fumes outside the cellar or floor area. Therefore, the whole pretreatment section is divided into an upper wet emission part and a dry floor area.

The fumes are continuously extracted through an extraction channel and fed to a wet scrubber unit for purification. The scrubbing water contains hydrochloric acid that is reused in the pickling process.

The extraction system is designed to create a negative pressure atmosphere inside the enclosure to ensure that no fumes can escape. The supply air flow is adjustable. The exhaust air flow depends on the actual differential pressure conditions and is controlled by a frequency converted exhaust fan. Open transport gates result in increasing fan power, and there is reduced fan power and air flow when all gates are closed. [161, DE TWG member 2019]

Achieved environmental benefits

- Substantially reduced emissions of hydrochloric acid to the environment.
- Resource conservation – the whole BG plant is protected from corrosion by acid attack.
- Reuse of HCl in the scrubbing water, thus saving resources by reducing the fresh HCl input. [161, DE TWG member 2019]

Environmental performance and operational data

In total, 23 BG plants in the FMP data collection reported the use of an enclosed pre-treatment section with abatement. Table 6.6 summarises the HCl emissions obtained at these plants over the 3-year period considered in the FMP data collection. At these plants, the temperature of the acid bath ranged typically from 10°C to 30°C and the exhaust flow rate ranged from 1 298 Nm³/h to 70 000 Nm³/h.

Table 6.6: HCl emissions from batch galvanising plants equipped with an enclosed pre-treatment section and abatement (wet scrubber)

Substance	Concentrations reported over 3-year period - (mg/Nm ³)					Number of plants / number of measurements
	Average	Median	90 th percentile	Min.	Max.	
HCl	3.2	1.2	8.0	0.5	8.9	23 / 35

Source: [16, FMP TWG 2018]

Cross-media effects

Energy input for the extraction system. [161, DE TWG member 2019]

Technical considerations relevant to applicability

Only applicable to new plants and major plant upgrades.

Economics

Costs may vary depending on specific plant conditions. [161, DE TWG member 2019]

Driving force for implementation

- Environmental legislation.
- Reduced workplace exposure to acid fumes for operators.
- Lower maintenance costs. [161, DE TWG member 2019]

Example plants

From the FMP data collection:

BG plant from the data collection, plant code: 1, 2, 3, 4, 5, 6, 7, 51, 52, 53, 61, 63, 169, 184, 185, 186, 224, 262, 284, 295, 296.

There are a number of plants (new or existing plants after retrofitting) in Europe and worldwide that are equipped with enclosed pre-treatment sections with abatement. These plants are summarised in Table 6.7.

Table 6.7: BG pickling plants (new or existing plants after retrofitting) equipped with enclosed pre-treatment and abatement

Company	Existing plant retrofitted	New plant
Seppeler Gruppe Feuerverzinkung Bremen	x	
Seppeler Gruppe Feuerverzinkung Osnabrück	x	
Seppeler Gruppe Feuerverzinkung Lennestadt	x	
Wiegel Zebrak Zarove Zinkovani s. r.o.	x	
Wiegel Velke Mezirici Zarove Zinkovani s.r.o.		x
Wiegel Kittlitz Feuerverzinken GmbH	x	
Wiegel Lauchhammer Feuerverzinken GmbH	x	
Wiegel Grüna Feuerverzinken GmbH		x
Wiegel Jena Feuerverzinken GmbH		x
Wiegel Neuwied Feuerverzinken GmbH & Co KG		x
Wiegel Großostheim Feuerverzinken GmbH	x	
Wiegel Höchststadt Feuerverzinken GmbH & Co KG		x
Wiegel Plankstadt Feuerverzinken GmbH & Co KG		x
Wiegel Trusetal Feuerverzinken GmbH		x
Wiegel Ichtershausen Feuerverzinken GmbH	x	
Wiegel Denkendorf Feuerverzinken GmbH		x
Wiegel Bodelshausen Feuerverzinken GmbH	x	
Wiegel Aitrach Feuerverzinken GmbH		x
Wiegel Feldkirch Feuerverzinken GmbH	x	
Wiegel Rheinau Feuerverzinken GmbH & Co KG		x
Wiegel Essenbach Feuerverzinken GmbH		x
Wiegel Bopfingen Feuerverzinken GmbH	x	
Wiegel Günzburg Feuerverzinken GmbH & Co KG		x
Wiegel Sered		x
Wiegel CZ zarove zinkovani s.r.o. Werk Hradec Kralove	x	
Wiegel Pravecice zarove zinkovani		x
Zinkpower Vorchdorf, AT		x
Zinkpower Sinabelkirchen, AT		x
Zinkpower Hamburg, DE		x
Zinkpower Berlin, DE		x
Zinkpower Lahr, DE	x	
Zinkpower Meckenheim, DE		x
Zinkpower Neumünster, DE	x	
Zinkpower Radebeul, DE	x	
Zinkpower Rostock, DE		x
Zinkpower Schönberg, DE		x
Zinkpower Schörg, DE		x
Zinkpower Krieger, DE		x
Zinkpower Ostrava, CZ		x
Zinkpower Roudnice, CZ		x
Zinkpower Promptus, CZ		x
Zinkpower Malacky, SK		x
Zinkpower Martin, SK		x
Zinkpower Moson, HU		x
Zinkpower Buk, PL		x
Zinkpower Wielkopolska, PL		x
Zinkpower Wschod, PL		x
Zinkpower Monterrey, MEX		x
Zinkpower Sao Paulo, BR		x
Zinkpower Middle East, ARE		x
Zinkpower Austrindo, IDN		x
Source: [161, DE TWG member 2019]		

Reference literature

[161, DE TWG member 2019]

6.4.3 Rinsing

See information in Sections 8.6.3.1 and 8.7.6.

6.4.4 Fluxing

See information in Sections 8.6.3.2, 8.6.3.3 and 8.6.3.4.

6.4.5 Hot dipping

6.4.5.1 Optimised dipping time

Description

The dipping time is limited to the duration required to achieve the coating thickness specifications.

Technical description

No information provided.

Achieved environmental benefits

Increased material efficiency.

Environmental performance and operational data

No information provided.

Cross-media effects

None.

Technical considerations relevant to applicability

Generally, there are no technical restrictions to the applicability of this technique.

Economics

Savings result from the reduced zinc consumption.

Driving force for implementation

Reduced costs due to increased material efficiency.

Example plants

Widely used.

Reference literature

No reference literature provided.

6.4.5.2 Slow withdrawal of workpieces from the bath

Description

By withdrawing the galvanised workpieces slowly from the galvanising kettle, the drain-off is improved.

Technical description

No information provided.

Achieved environmental benefits

Increased material efficiency.

Environmental performance and operational data

No information provided.

Cross-media effects

None.

Technical considerations relevant to applicability

Generally, there are no technical restrictions to the applicability of this technique.

Economics

Savings result from the reduced zinc consumption.

Driving force for implementation

Reduced costs due to increased material efficiency.

Example plants

BG plant from the data collection, plant code: 1, 2, 4, 5, 6, 7, 54, 61, 62, 63, 64, 72, 74, 75, 76, 85, 103, 224, 226, 234, 235, 259, 260, 261, 262, 277, 279, 280, 281, 282, 283, 284, 292, 293, 294.

Reference literature

[\[16, FMP TWG 2018 \]](#).

6.4.5.3 Modified fluxing solution to increase the aluminium content of the bath

Description

By means of a modified fluxing solution, the aluminium content of the zinc bath can be increased to 0.03–0.05 wt-%. This provides brighter surface finish and the coating reduces the reactivity of reactive steels exhibiting high silicon and/or phosphorus content. [\[148, IT 18-4-17 2017 \]](#)

Technical description

Most galvanising plants add aluminum to the molten zinc bath at levels of 0.002–0.006 wt-% for better fluidity and brighter appearance of the galvanised coating. Moreover, the addition of aluminium allows to better control the coating thickness, as it reduces the reactivity of so-called reactive steels (i.e. steels with high silicon and/or phosphorus content). [\[148, IT 18-4-17 2017 \]](#)

The amount of aluminium that can be added to the bath is however limited, as the aluminum can react with the zinc-ammonium chloride from the fluxing solution, causing defects such as bare/black spots in the coatings. [\[162, American Galvanizers Association 2015 \]](#)

By means of a modified (patented) composition of the fluxing solution, it is possible to increase the aluminium content in the bath to 0.03–0.05 wt-%. This increases the fluidity of the zinc bath

and, more importantly, reduces the rate of the zinc-iron reaction, specifically in the case of the so-called reactive steels. Consequently, this results in reduced zinc consumption. [148, IT 18-4-17 2017]

Achieved environmental benefits

Increased material efficiency.

Environmental performance and operational data

Reported performance data indicate that additions of aluminium up to 0.03 wt-% can reduce the coating thickness on so-called hyper-sandelin steel (i.e. steel with a high silicon content) by approximately 20 %, but do not cause any thickness reduction on hypo-sandelin steel (i.e. steel with a low silicon content), where a reduction would not be desirable. When adding 0.05 wt-% of nickel (a more commonly used element to control the reactivity of reactive steels), the obtained thickness reduction was reported to be only 5 %. [148, IT 18-4-17 2017]

Cross-media effects

Some additional aluminium is consumed due its higher content in the bath.

Technical considerations relevant to applicability

No information provided.

Economics

Savings result from the reduced zinc consumption.

Driving force for implementation

Reduced costs due to increased material efficiency.

Example plants

A large number of BG plants reported the use of Al additions to control steel reactivity: 1, 2, 4, 5, 6, 7, 54, 61, 62, 63, 64, 72, 74, 75, 76, 85, 103, 185, 188, 224, 226, 234, 235, 236, 259, 260, 261, 262, 277, 279, 280, 281, 282, 283, 284, 292, 293, 294.

However, it is unclear if any of these plants apply the specific technique described in this section. Indeed, this technique is highly specialised and is generally used in very few BG plants.

Reference literature

[16, FMP TWG 2018], [148, IT 18-4-17 2017].

6.4.5.4 Recovery and use of zinc-containing particles from steam blow-off (tube finishing)

Description

Zinc-containing particles from blowing off excess zinc from galvanised tubes are recovered. They are reused in the galvanising kettle or sent for zinc recovery.

Technical description

Zinc-containing particles originating from steam blow-out of galvanised tubes are collected. They can be returned to the galvanising kettle. Alternatively, the particles can be used in the secondary zinc industry.

Achieved environmental benefits

- Increased material efficiency.
- Reduction of waste sent for disposal.

Environmental performance and operational data

No information provided.

Cross-media effects

None.

Technical considerations relevant to applicability

Generally, there are no technical restrictions to the applicability of this technique.

Economics

Savings result from the reuse of zinc-containing particles in the galvanising kettle or from selling them to the secondary zinc industry.

Driving force for implementation

Reduced costs due to increased material efficiency.

Example plants

No information provided.

Reference literature

No reference literature provided.

6.4.5.5 Thin film coating in batch galvanising

Description

Zinc coatings of 5–10 μm (compared to well over 80 μm from the standard process) are achieved by using the eutectic zinc-aluminium alloy (95 % Zn, 5 % Al).

Technical description

The thin film galvanising technology is based on the batch galvanising method using a eutectic zinc-aluminium alloy (95 % Zn, 5 % Al). The required wetting behaviour of steel with this kind of zinc alloy is attained by means of a special pretreatment of the steel surface before the galvanising step. The characteristics of the resulting zinc layer are significantly influenced by the high aluminium content in the molten zinc alloy in the kettle. The kinetics of the zinc layer formation are controlled in order to suppress the diffusion process from zinc and iron and hence the formation of zinc-iron phases common in the conventional batch galvanising process according to ISO 1461. Instead, with the thin film galvanising technology, the zinc coating is characterised by a eutectic structure with globular, hypoeutectic Zn-rich β - phase substructures, where the layer thickness is limited to an average of 10 μm . [\[213, EGGA 2022 \]](#)

Achieved environmental benefits

- Possible reduction of zinc consumption per m^2 of coated surface by more than 80 %, if customer specifications do not require corrosion protection according to ISO 1461.
- The reduction of the zinc bath temperature saves energy.
- There is no bottom dross and zinc ash accumulation is low. Therefore the thin film galvanising technology significantly reduces the amount of zinc-containing residues (see Table 6.8).

Environmental performance and operational data

The performance of the thin film galvanising technology can be evaluated using the specific consumption per m^2 of coated surface (see Table 6.8). It should be noted that Environmental Product Declarations for corrosion protection of fabricated steel articles are usually based on a 'per year of protection' functional unit.

Table 6.8: Performance of the thin-film galvanising technology

Specific consumption or waste generation per m ² of coated surface	Zinc (g/m ²)	Energy (kWh/m ²)	Bottom Dross (g/m ²)	Zinc ash (g/m ²)
Thin-film galvanising technology	200	10.5	NA	70

Source: [213, EGGA 2022]
 Note: the data presented for the thin film (5-10µm) galvanising process refers to its first year of operation (2017). In 2015 and 2016 only 'start-up operation' took place.

Like the standard process, the thin film galvanising process involves the chemical cleaning of steel. An absolutely grease-free and clean surface is a prerequisite for the subsequent process steps. The required wetting behavior of steel with this type of zinc alloy is achieved by means of a special temperature-resistant flux. The material is then preheated to temperatures > 100 °C in the drying oven (conventional BG < 100 °C). The hot dip galvanising kettle is made of a special material that prevents the Zn-Al alloy from attacking the walls of the kettle.

Cross-media effects

None.

Technical considerations relevant to applicability

In general, the thin film galvanising process can be applied unless a galvanised coating thickness according to ISO 1461 is required by the customer for higher levels of corrosion protection.

Economics

The process steps in the thin film galvanising process are mostly the same as in the standard process according to ISO 1461. However, in view of the requirement for a very clean surface after pretreatment, additional investment costs may occur due to an intensification of the pretreatment. In addition, the drying oven needed for material preheating and the special material of the galvanising vessel increase the investment volume. As a rough estimate, it can therefore be assumed that the capital costs for the thin film galvanising technology are by a factor of 1.1 to 1.3 (depending on the degree of automation) higher than for the standard technology according to ISO 1461.

The savings potential of the thin film galvanising technology lies in the reduced use of zinc (and savings in the area of reduction of generation of zinc-containing residues).

Driving force for implementation

Reduced consumption of zinc in less demanding applications.

Example plants

Plant in Hagen, DE.

Reference literature

[213, EGGA 2022]

6.4.6 Emissions to water

6.4.6.1 Waste water discharge in batch galvanising

Description

No waste water is discharged from batch galvanising.

Technical description

Only liquid residues (e.g. spent pickling acid, spent degreasing solutions and spent fluxing solutions) are generated. These residues are collected. They are appropriately treated for recycling or recovery and/or sent for disposal (see Section 8.6.5 and Sections 6.4.2.3 to 6.4.2.5).

6.5 Emerging techniques for batch galvanising

No techniques reported.

7 CURRENT CONSUMPTION AND EMISSION LEVELS FOR PROCESSES COMMON TO MORE THAN ONE SECTOR

7.1 Acid recovery

All the figures related to emissions to air from acid recovery are composed of three sections. The upper part shows the maximum emission concentrations for each of the three reporting years, and the average value obtained over the reporting period. Below the x-axis, in the middle part of the graph, contextual informations are included such as the type of acid recovery technique, the type of acid used, the O₂ measured value reported corresponding to the maximum concentration over the three reporting years and the BAT candidates applied. Finally, the lower part of the graph shows the mass flow values, corresponding either to the maximum concentration obtained over the reporting period or the average mass flow over the three reporting years. All the figures are sorted in ascending order of the maximum concentration values for the three operating years.

7.1.1 Emissions to air

A very large majority of cold rolling plants reported in the FMP data collection that acid recovery operations were carried out on site. In total, 44 cold rolling lines (39 plants) reported data during the information exchange. Out of these 39 plants, only 7 plants (including 4 plants in Germany and 3 plants in Sweden - 8 lines) reported that acid recovery was carried out off site. For these sites, it is the responsibility of the plant operator to ensure that the acidic residues are sent for appropriate recovery to a third party.

Dust emissions

The data reported on dust emissions to air from acid recovery are shown in Figure 7.1 (values are given as measured, without any conversion to a reference oxygen concentration). The figure includes 5 emission points from hot rolling plants and 21 emission points from cold rolling plants. Emission concentrations ranged from 1.0 mg/Nm³ to 137 mg/Nm³ and emission loads ranged from 3.7 g/h to 1 047 g/h.

HCl emissions

The data reported on HCl emissions to air from acid recovery are shown in Figure 7.2 (values are given as measured, without any conversion to a reference oxygen concentration). The figure includes 5 emission points from hot rolling plants and 17 emission points from cold rolling plants. Emission concentrations ranged from 0.6 mg/Nm³ to 226 mg/Nm³ and emission loads ranged from 12.3 g/h to 1 450 g/h.

SO₂ emissions

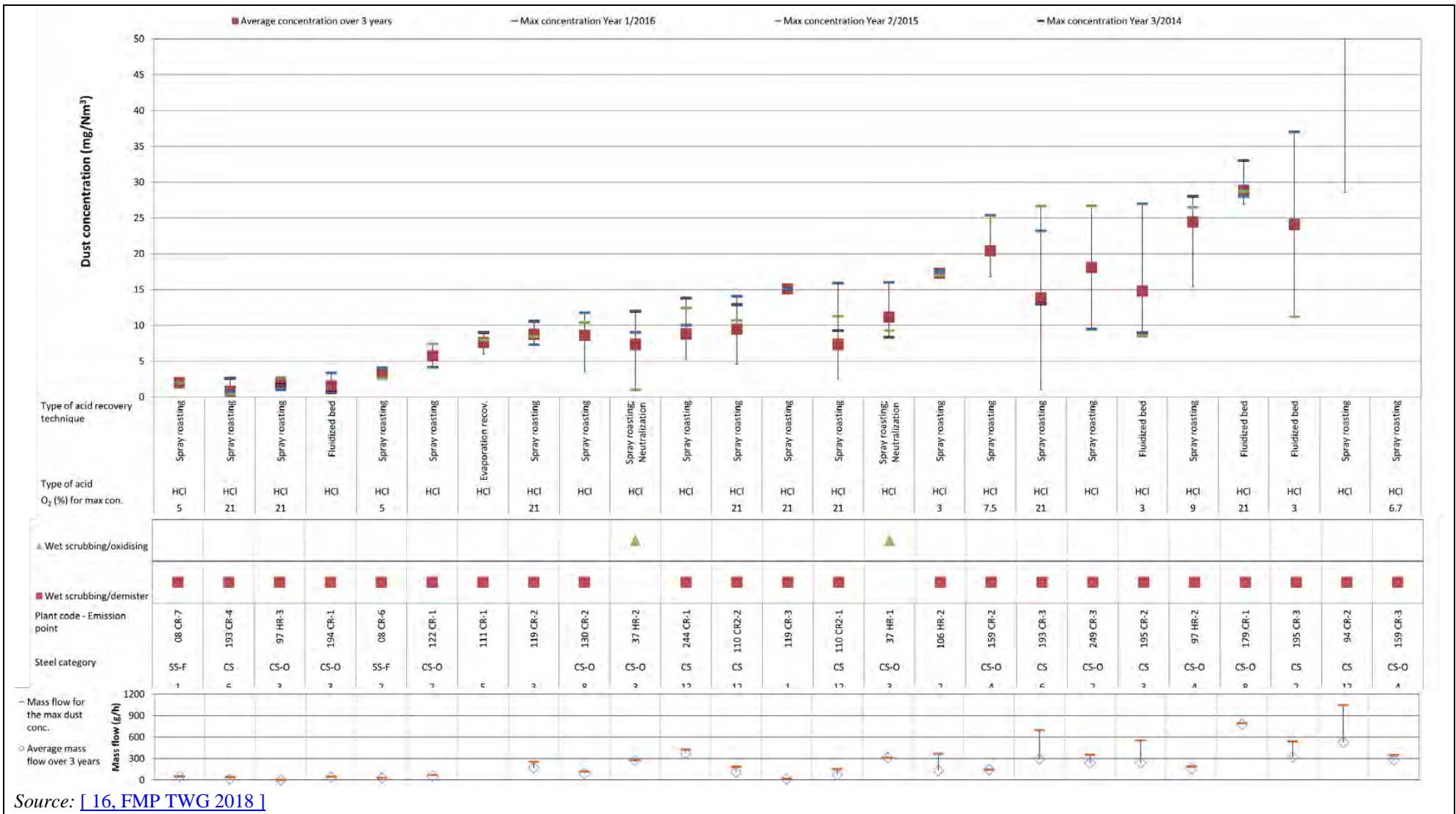
The data reported on SO₂ emissions to air from acid recovery are shown in Figure 7.3 (values are given as reported, without conversion to a reference oxygen concentration). The figure includes 2 emission points from hot rolling plants and 9 emission points from cold rolling plants. Emission concentrations ranged from 0.4 mg/Nm³ to 34.9 mg/Nm³ and emission loads ranged from 1.0 g/h to 447 g/h.

NO_x emissions

The data reported on NO_x emissions to air from acid recovery are shown in Figure 7.4 (values are given as measured, without any conversion to a reference oxygen concentration) The figure includes 3 emission points from hot rolling plants (HR in the plant code) and 18 emission points from cold rolling plants (CR in the plant code). The concentrations ranged from 0.6 mg/Nm³ to 230 mg/Nm³ and the emission loads ranged from 0.6 g/h to 15 300 g/h.

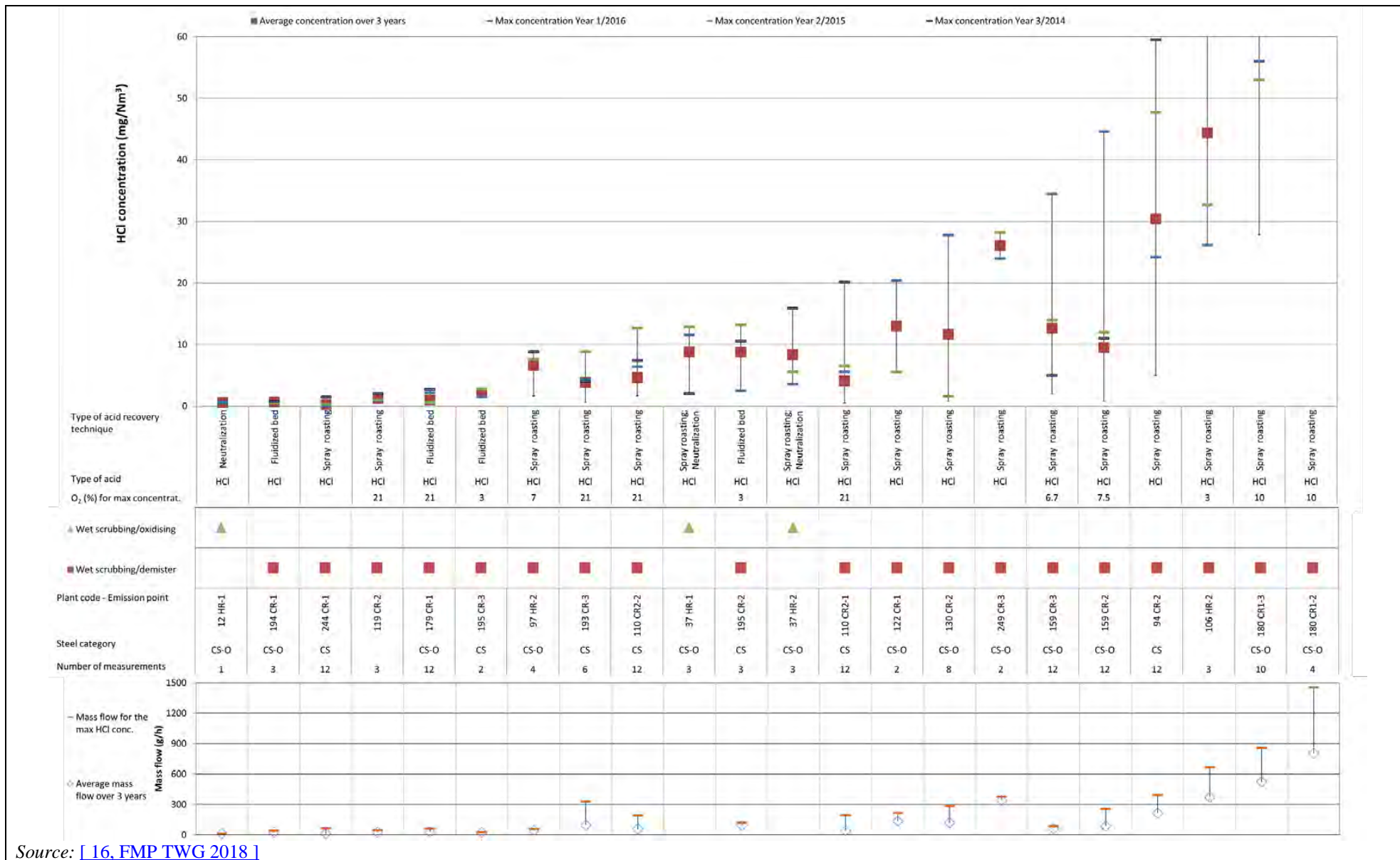
HF emissions

The reported data on HF emissions to air from acid recovery are shown in Figure 7.5 (values are given as measured, without any conversion to a reference oxygen concentration). The figure includes 1 emission point for a hot rolling plant and 2 emission points from cold rolling plants. Emission concentrations ranged from 0.1 mg/Nm³ to 0.4 mg/Nm³ and emission loads ranged from 0.3 g/h to 4.0 g/h.



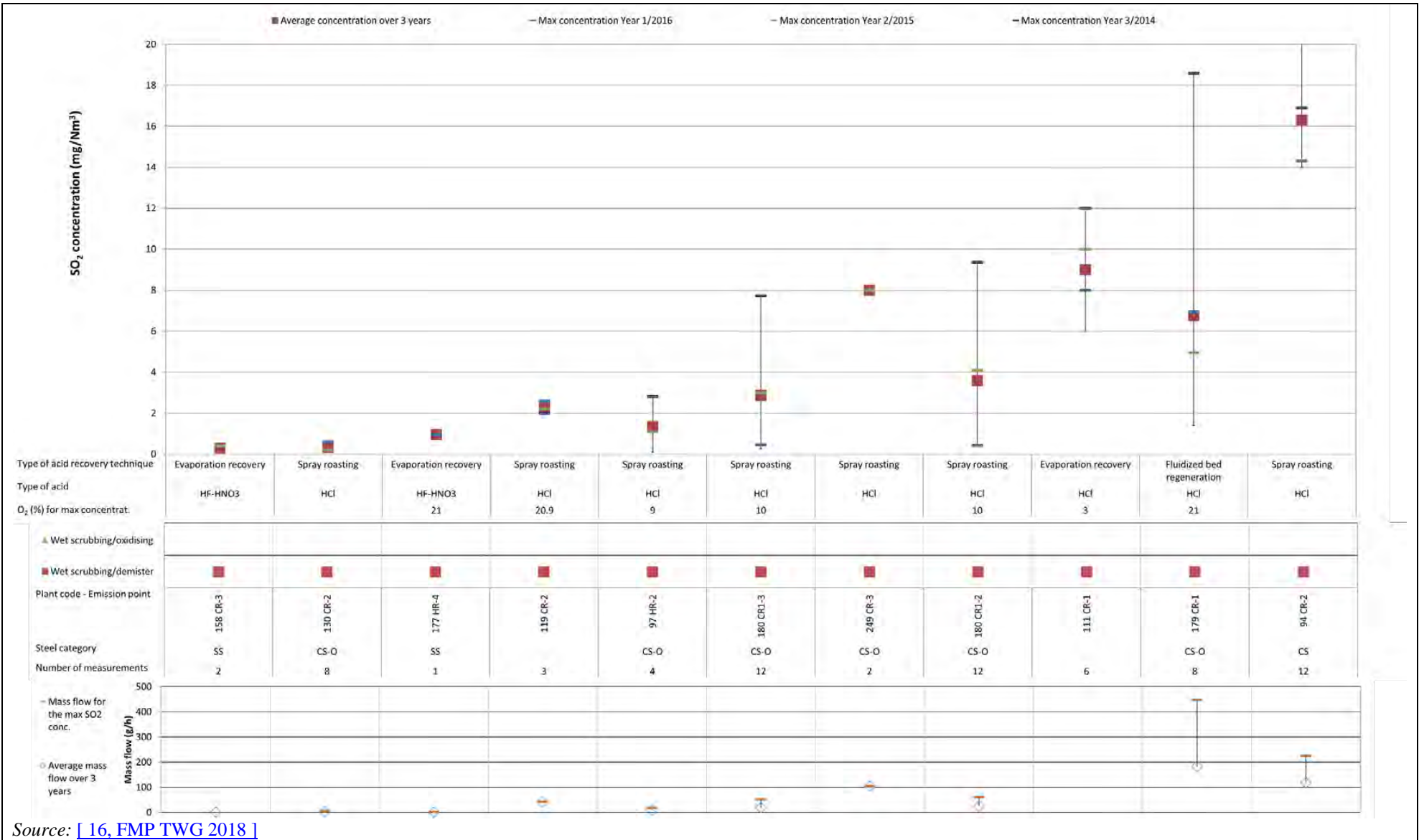
Source: [16, FMP TWG 2018]

Figure 7.1: Dust emissions from acid recovery (in mg/Nm³)



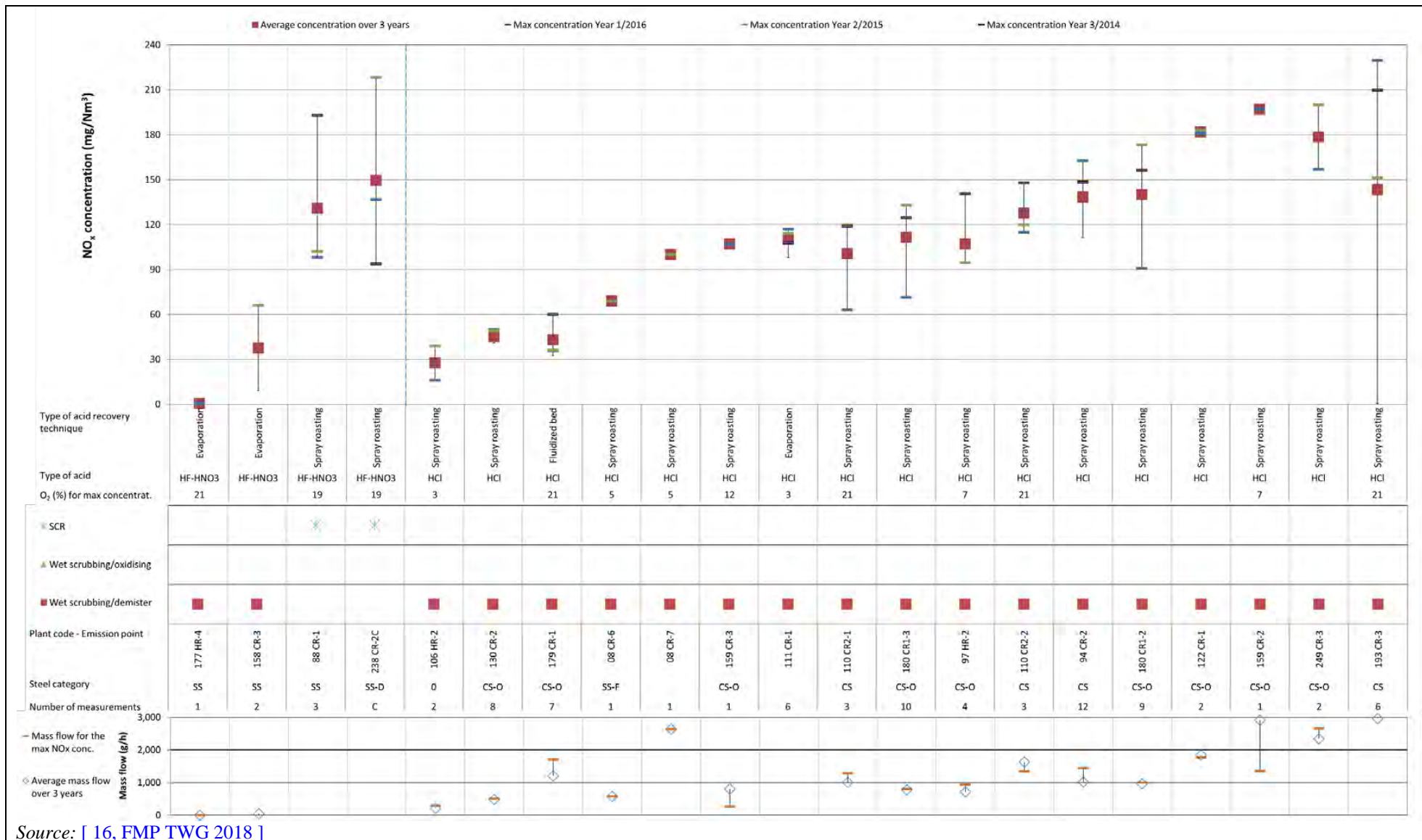
Source: [16, FMP TWG 2018]

Figure 7.2: HCl emissions from acid recovery (in mg/Nm³)



Source: [16, FMP TWG 2018]

Figure 7.3: SO₂ emissions from acid recovery (in mg/Nm³)



Source: [16, FMP TWG 2018]

Figure 7.4: NO_x emissions from acid recovery (in mg/Nm³)

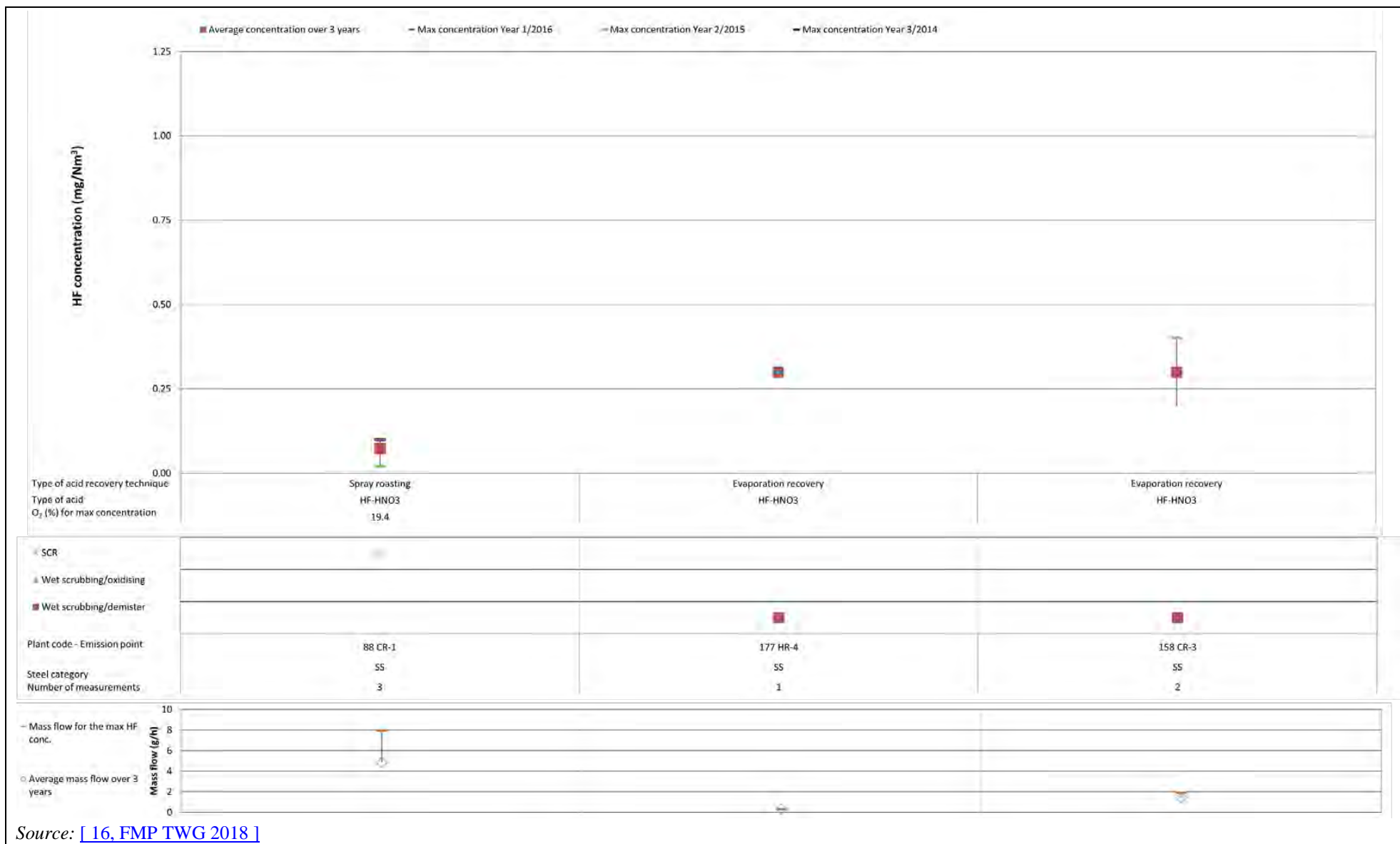


Figure 7.5: HF emissions from acid recovery (in mg/Nm³)

7.2 Waste water treatment of streams from more than one sector

7.2.1 Emissions to water

This section contains information on the emissions to water from treatment plants processing waste waters originating from one FMP sector or originating from more than one FMP sector (common waste water treatment plants). Other streams from non-FMP sectors may be treated together, but this was only taken into consideration in this document when more than 50% of the volume streams originate from FMP processes.

Figures related to emissions to water consist of three sections. The upper part shows the maximum concentration of each of the three reporting years, and the average value obtained over the reporting period. Below the x-axis, information is included such as the point of release, the FMP sector and the number of measurements reported. In the eventuality that the waste water discharge contains other waste water contribution from non FMP sectors, it is specified in the graph. For the points of releases belonging to a FMP sector, the steel category is reported. For points of releases belonging to a CWWTP, releases with less than 50% of contribution from a FMP sector were not taken into account. The graph also shows the average mass flow values, either for the maximum concentration obtained over the reporting period or the average for the year when the maximum concentration was obtained. The lower part of the graph provides information on the BAT candidates applied. All the figures are sorted in ascending order of the maximum concentration values for the three operating years.

Table 7.1: Direct emissions to water from hot rolling (HR), cold rolling (CR), wire drawing (WD), hot dip coating (HDC) plants and from common waste water treatment plants

Substance/Parameter	HR		CR		WD		HDC		CWWTP		
	Number of emission points	Concentration range (mg/l) ¹	Number of emission points	Concentration range (mg/l) ¹	Number of emission points	Concentration range (mg/l) ¹	Number of emission points	Concentration range (mg/l) ¹	Number of emission points	Concentration range (mg/l) ¹	
Total suspended solids (TSS)	29	2.3-200	12	2.3-27.4	3	6.0-14.7	4	2.2-15.4	8	1.3-51.5	
Total organic carbon (TOC)	11	1.6-8.9	2	8.3-9.9	NI	NI	1	0.04	2	7.3-8.5	
Chemical oxygen demand (COD)	28	4.7-130	10	11.7-178	NI	NI	7	11.7-117	12	8.9-194	
Hydrocarbon oil index (HOI)	18	0.1-2.7	8	0.09-11.6	NI	NI	1	0.5	5	0.1-3.3	
Metals	Cd	25	0.1-15 µg/l	5	0.2-5 µg/l	NI	NI	2	0.3-5 µg/l	8	0.1-10 µg/l
	Cr	40	0.002-0.15	16	0.002-0.10	NI	NI	8	0.002-0.07	13	0.001-1.4
	Cr(VI)	10	2.8-50 µg/l	9	1.0-86.7 µg/l	1	0.01 µg/l	6	1.0-24.2 µg/l	7	5.7-358 µg/l
	Fe	38	0.01-9.9	18	0.01-43.6	NI	NI	10	0.1-2.2	12	0.1-6.7
	Hg	16	0.01-10 µg/l	3	0.07-0.3 µg/l	NI	NI	2	0.1-0.7 µg/l	3	1.0-1.5 µg/l
	Ni	41	0.01-1.1	15	0.004-0.2	NI	NI	6	0.004-0.02	13	0.001-0.4
	Pb	29 ²	0.1-42.7 µg/l	7	0.2-8.7 µg/l	2	1.0-5.7 µg/l	3	3.5-10.0 µg/l	13	0.6-67.2 µg/l
	Sn	NI	NI	NI	NI	NI	NI	1	0.0001	3	0.07-0.1
Zn	4	0.02-0.2	1	0.02	NI	NI	NI	NI	NI	NI	
Total phosphorus (P)	18	0.06-3.0	NI	NI	NI	NI	NI	NI	11	0.03-5.7	
Fluoride (F ⁻)	9	0.1-26.7	3	4.3-8.6	NI	NI	NI	NI	6	0.5-8.0	

Concentration ranges correspond to the average values for the 3 reporting years of measurements.

¹Except when specified that the concentration is expressed in µg/l.

²In total, 3 hot rolling plants in the data collection (267 HR, 268 HR, 269 HR) reported the production of leaded steel with emission concentrations of lead ranging from 4 to 88 µg/l (see Figure 7.32).

NI: No information provided.

Source: [16, FMP TWG 2018]

Table 7.2: Indirect emissions to water from hot rolling (HR), cold rolling (CR), wire drawing (WD), hot dip coating (HDC) plants and from common waste water treatment plants

Substance/Parameter	HR		CR		WD		HDC		CWWTP		
	Number of emission points	Concentration range (mg/l) ¹	Number of emission points	Concentration range (mg/l) ¹	Number of emission points	Concentration range (mg/l) ¹	Number of emission points	Concentration range (mg/l) ¹	Number of emission points	Concentration range (mg/l) ¹	
Total suspended solids (TSS)	13	8.0-374	7	4.0-437	1	3.0-62	6	7.0-79	4	27.0-88	
Total organic carbon (TOC)	7	3.1-18.4	NI	NI	NI	NI	NI	NI	NI	NI	
Chemical oxygen demand (COD)	12	13.0-546	2	28.0-546	NI	NI	NI	NI	2	110-1 580	
Hydrocarbon oil index (HOI)	11	0.07-3.6	2	1.7-5.5	NI	NI	6	0.1-6.5	4	0.2-2.0	
Metals	Cd	8	0.2-10.0 µg/l	1	20.0 µg/l	NI	NI	2	2-7.1 µg/l	4	0.3-8.7 µg/l
	Cr	21	0.0004-2.4	7	0.02-0.3	NI	NI	2	0.2-0.3	7	0.001-0.03
	Cr(VI)	2	5.0-7.0 µg/l	6	10.0-100 µg/l	2	0.01-156 µg/l	NI	NI	2	10 µg/l
	Fe	17	0.1-15.4	7	0.2-4.7	NI	NI	1	5.8	5	0.03-3.2
	Hg	12	0.02-10 µg/l	1	25 µg/l	NI	NI	1	1.0 µg/l	4	0.1-10.0 µg/l
	Ni	22	0.0004-2.2	6	0.08-0.6	NI	NI	2	0.02-0.08	7	0.01-0.1
	Pb	17	4.8-270 µg/l	2	100-123 µg/l	NI	NI	2	23.0-53.3 µg/l	5	0.3-69.1 µg/l
	Sn	NI	NI	NI	NI	NI	NI	1	0.1	2	0.01-0.2
Zn	21	0.01-345	6	0.05-0.4	NI	NI	6	0.7-1.5	7	0.001-0.9	
Total phosphorus (P)	11	0.08-5.2	NI	NI	NI	NI	NI	NI	2	0.4-3.5	
Fluoride (F ⁻)	4	0.4-4.7	1	14.5	NI	NI	NI	NI	2	0.08-4.7	

Concentration ranges correspond to the average values for the 3 reporting years of measurements.
¹Except when specified that the concentration is expressed in µg/l.
 NI: No information provided.
 Source: [16, FMP TWG 2018]

Figure 7.6 to Figure 7.43 show the reported data on emissions to water, for direct and indirect discharges, per pollutant.

A schematic showing examples of direct and indirect discharges in a generic waste water system is given in Figure 11.1. Different layouts of treatment lines in a common waste water treatment plant are shown in the schematic of Figure 11.2. The abbreviations used in the figures can be found in Section V of the glossary.

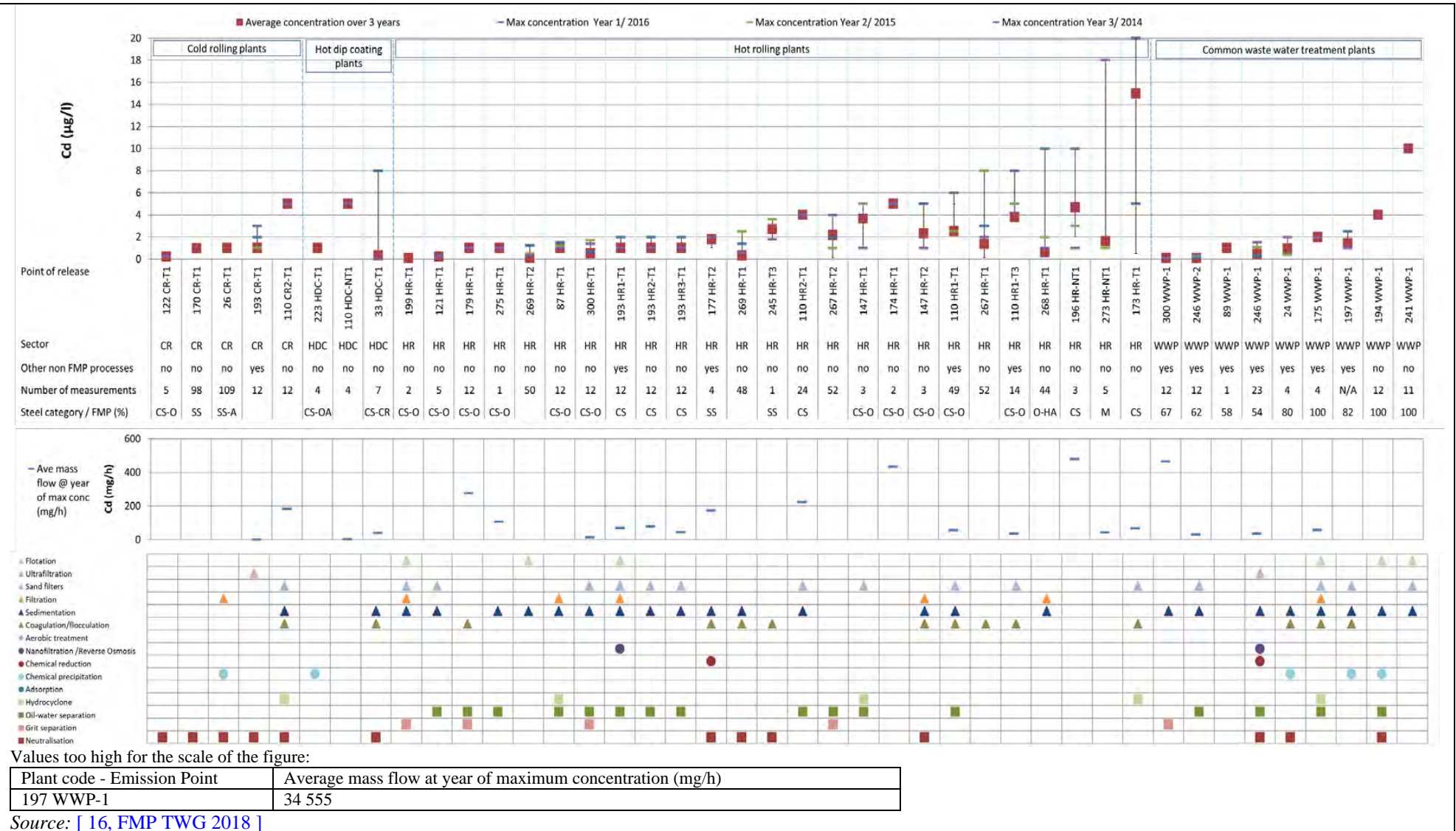


Figure 7.6: Cadmium emissions (in µg/l) for direct discharges

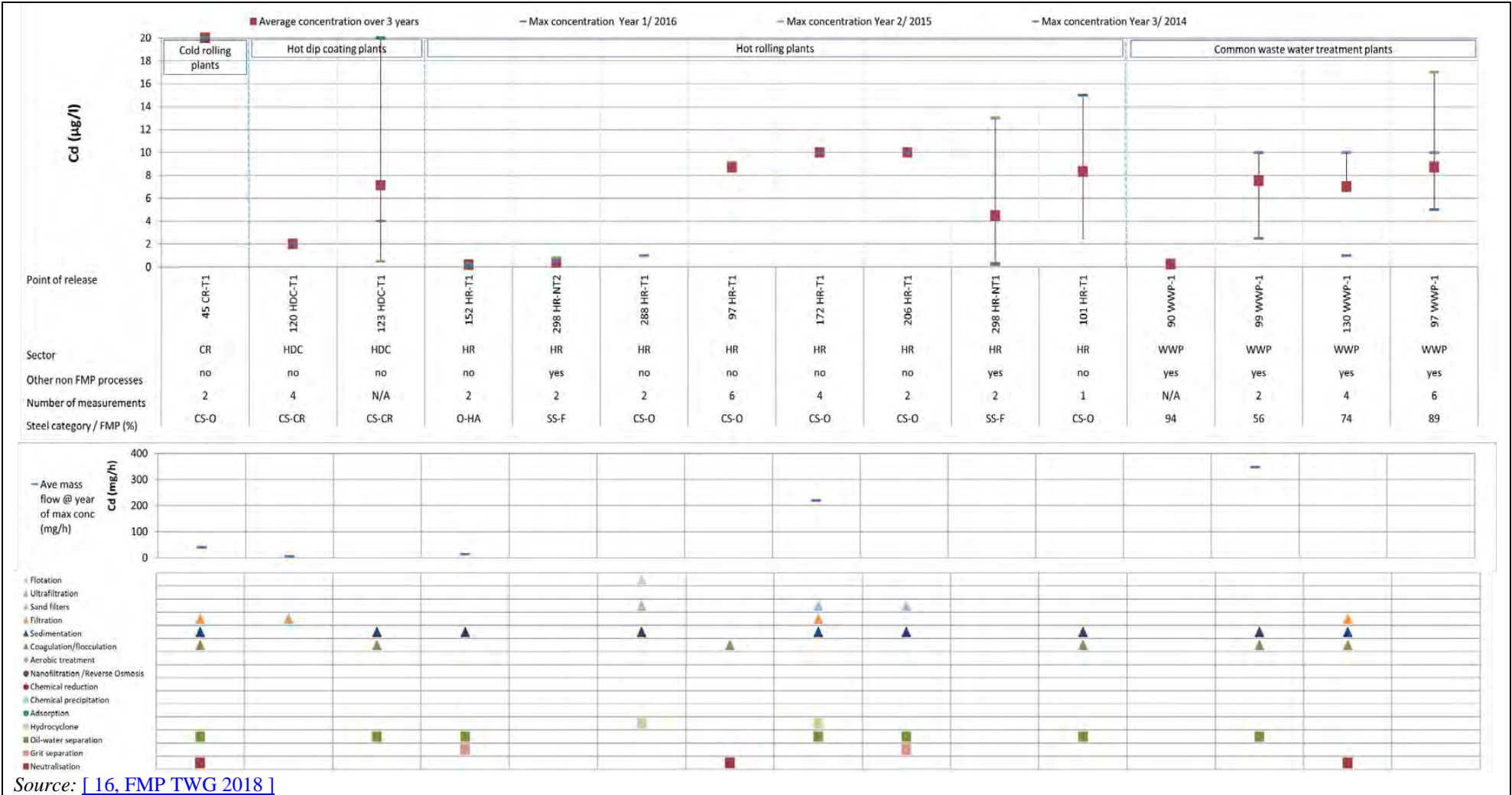


Figure 7.7: Cadmium emissions (in µg/l) for indirect discharges

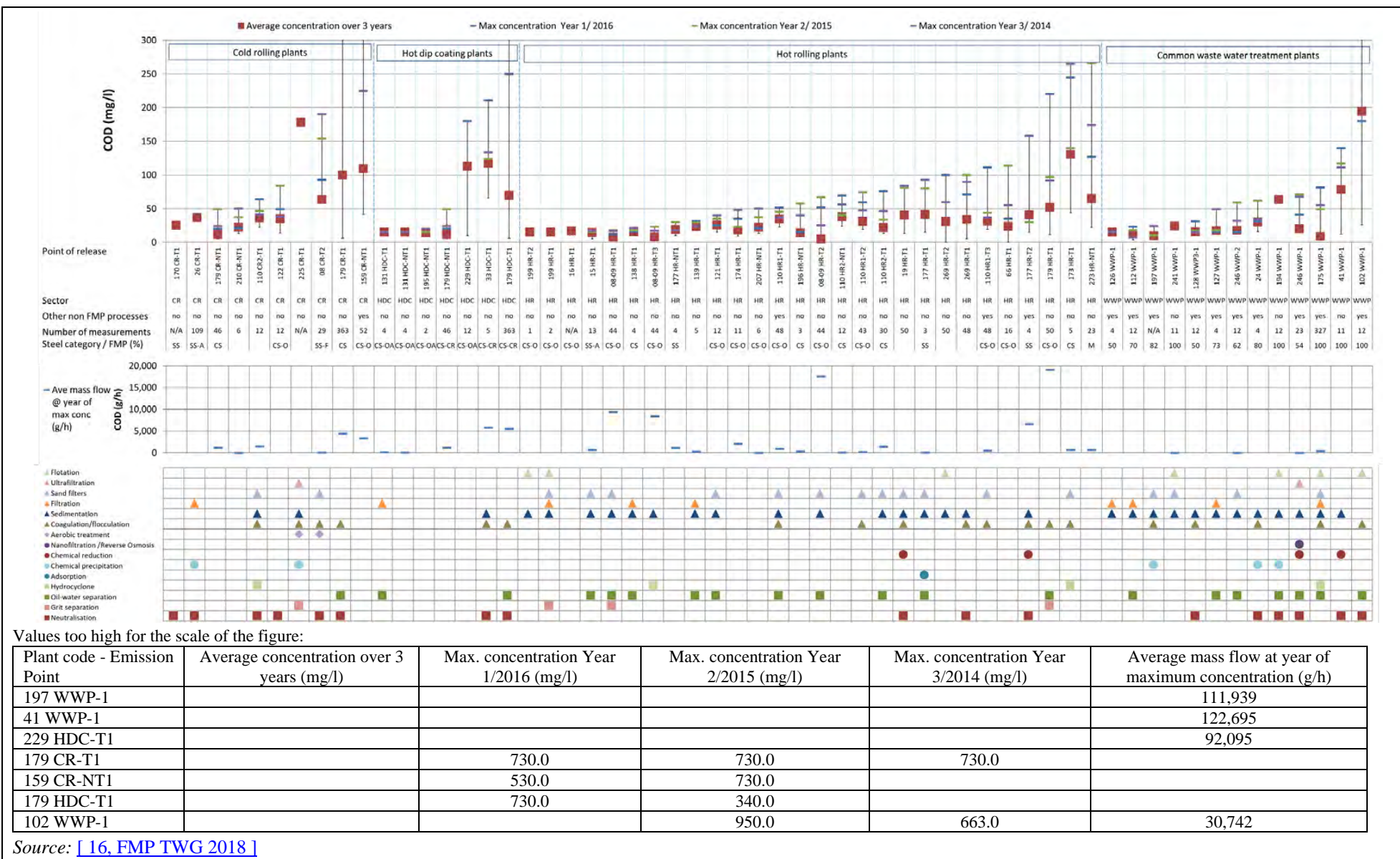
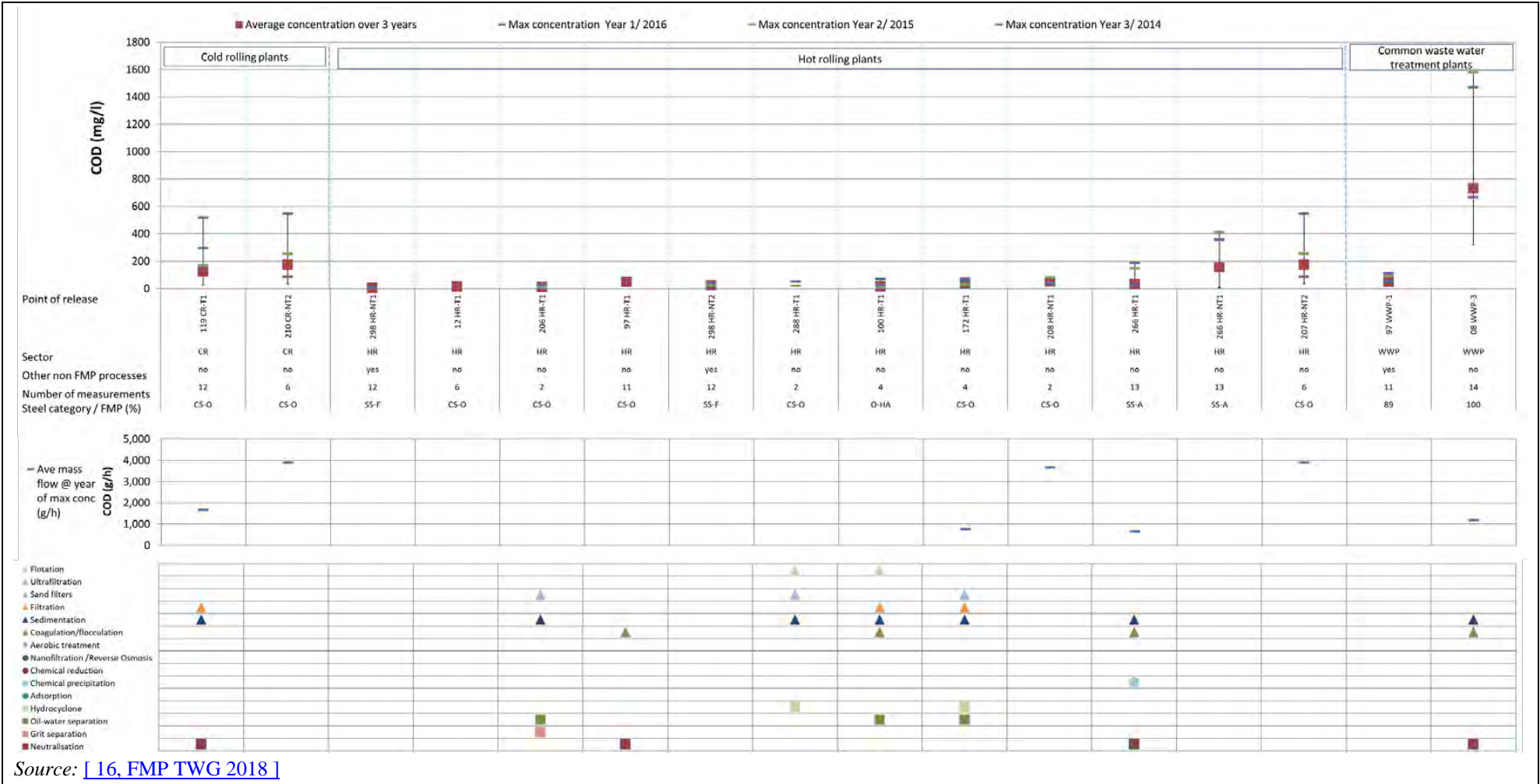


Figure 7.8: COD emissions (in mg/l) for direct discharges



Source: [16, FMP TWG 2018]

Figure 7.9: COD emissions (in mg/l) for indirect discharges

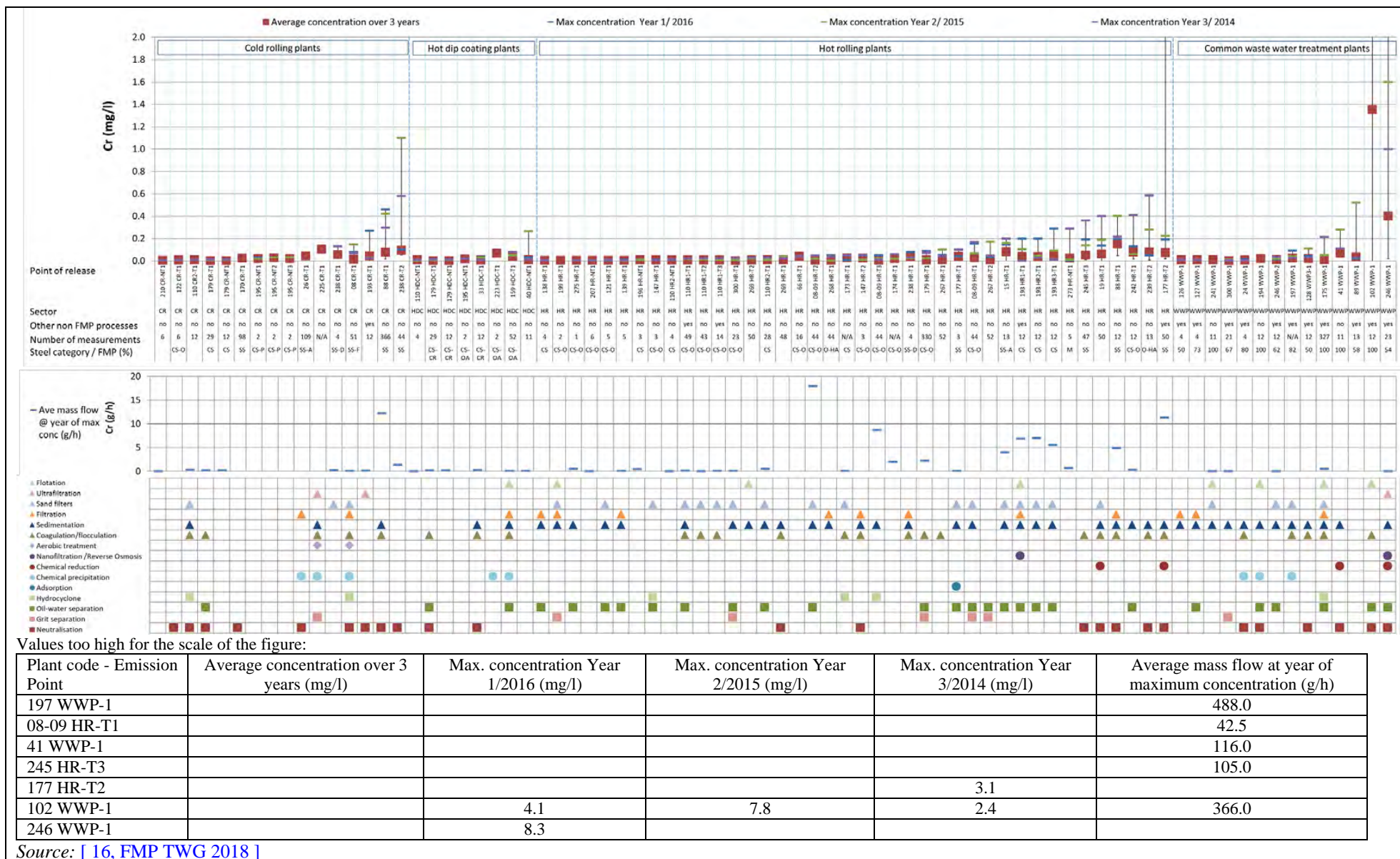
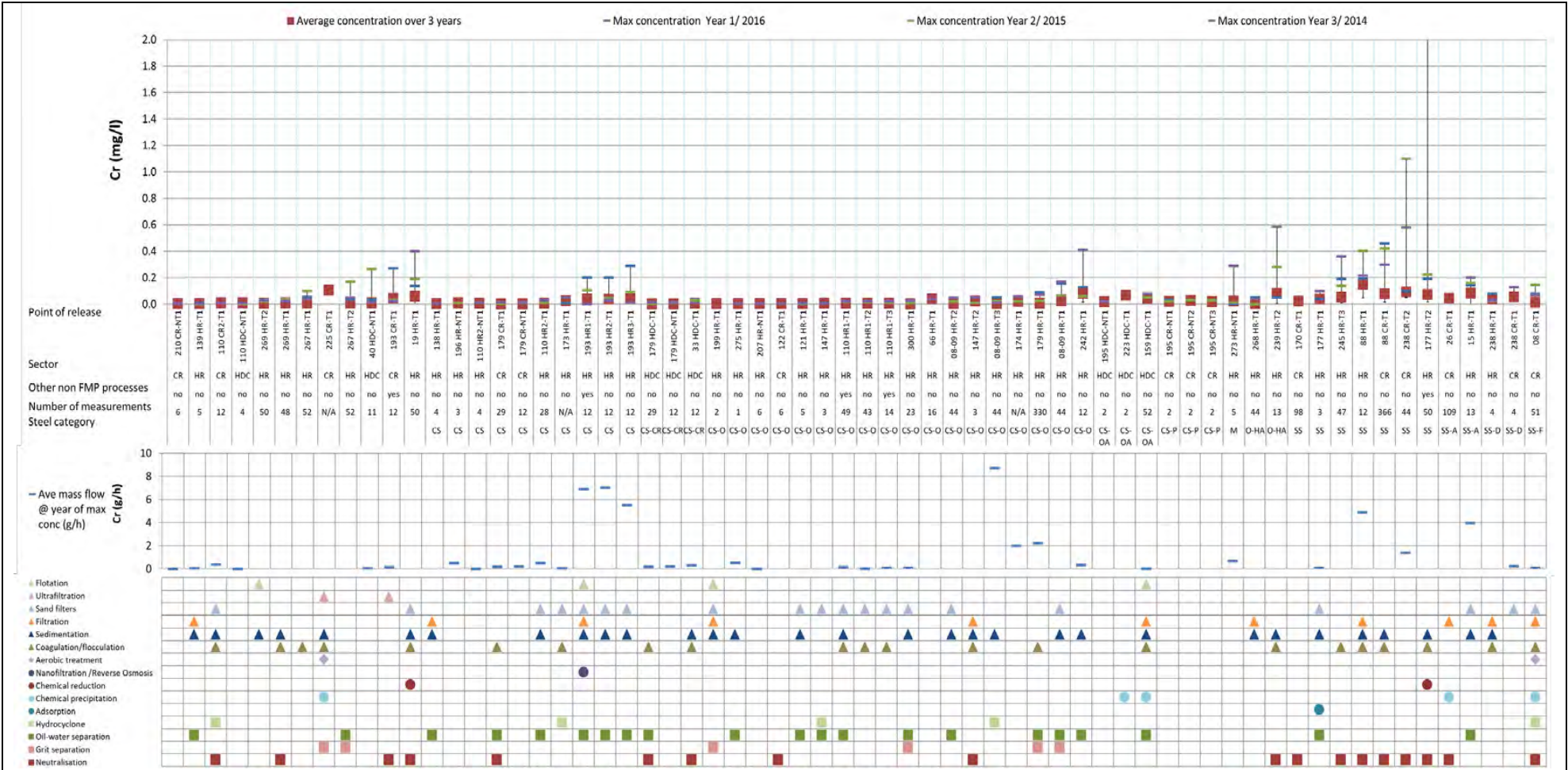


Figure 7.10: Chromium emissions (in mg/l) for direct discharges



Values too high for the scale of the figure:

Plant code - Emission Point	Average concentration over 3 years (mg/l)	Max. concentration Year 1/2016 (mg/l)	Max. concentration Year 2/2015 (mg/l)	Max. concentration Year 3/2014 (mg/l)	Average mass flow at year of maximum concentration (g/h)
08-09 HR-T1					42.5
177 HR-T2				3.1	
245 HR-T3					105.0

Source: [16. FMP TWG 2018]

Figure 7.11: Chromium emissions (in mg/l) for direct discharges (sorted by steel category)

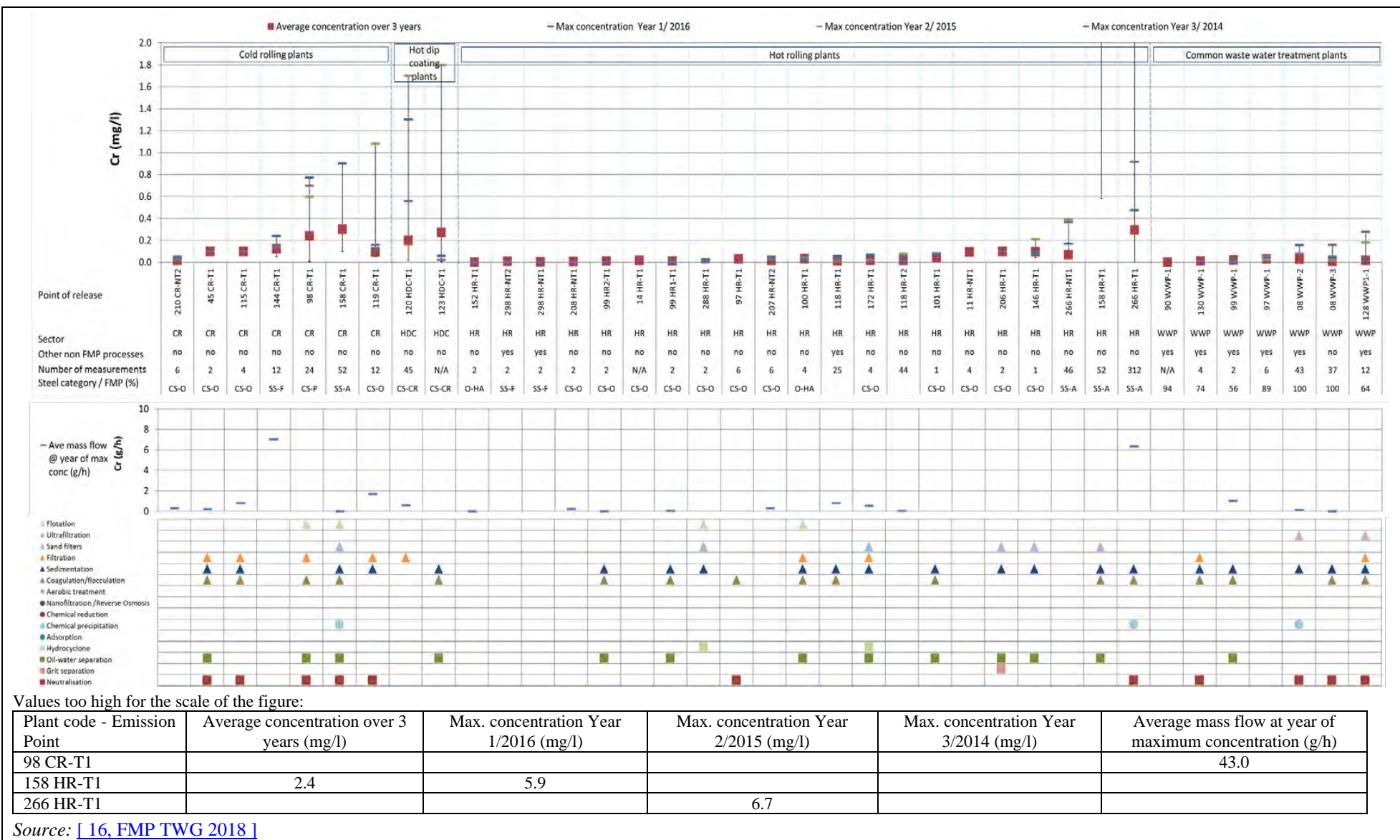
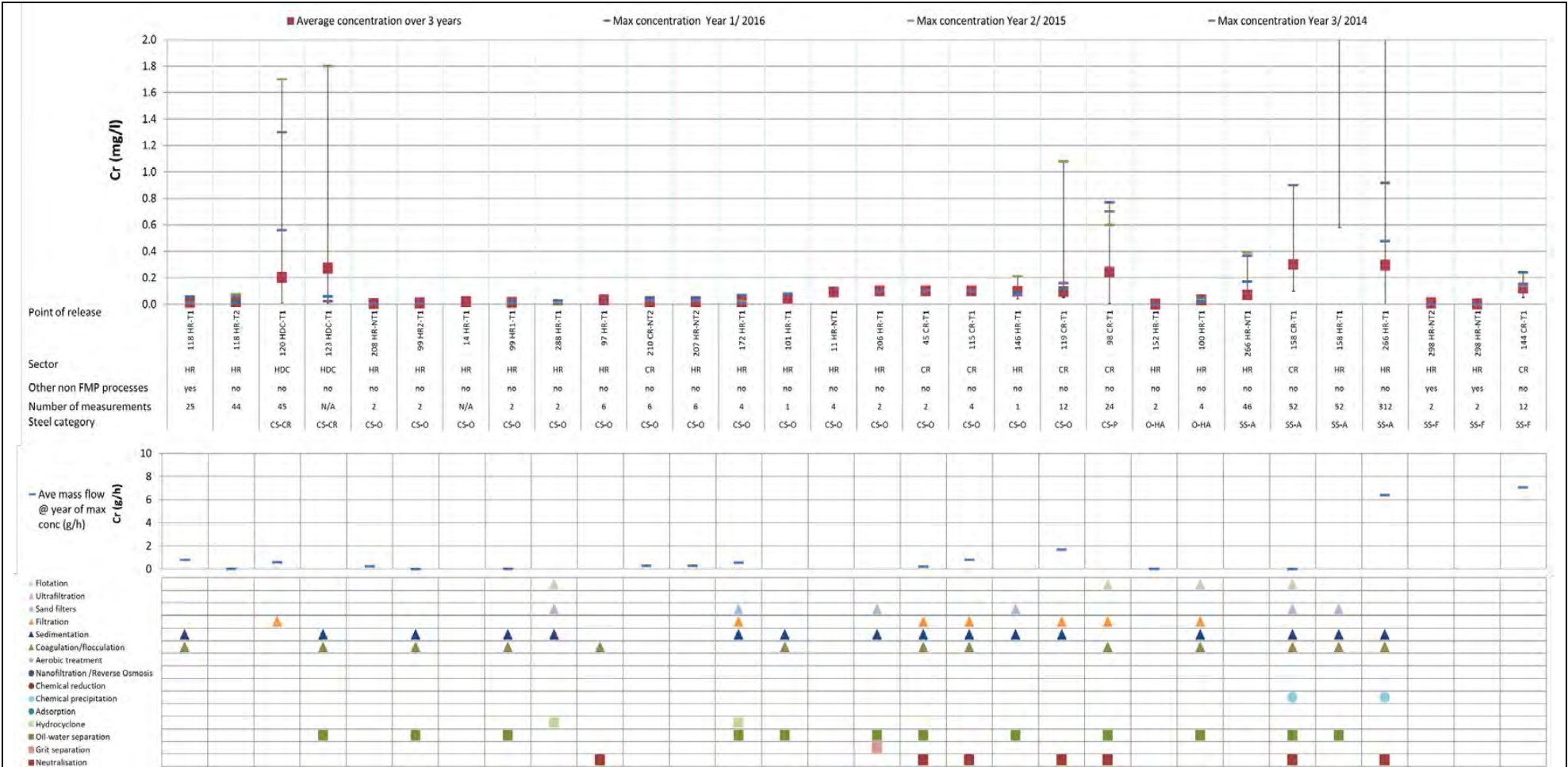


Figure 7.12: Chromium emissions (in mg/l) for indirect discharges

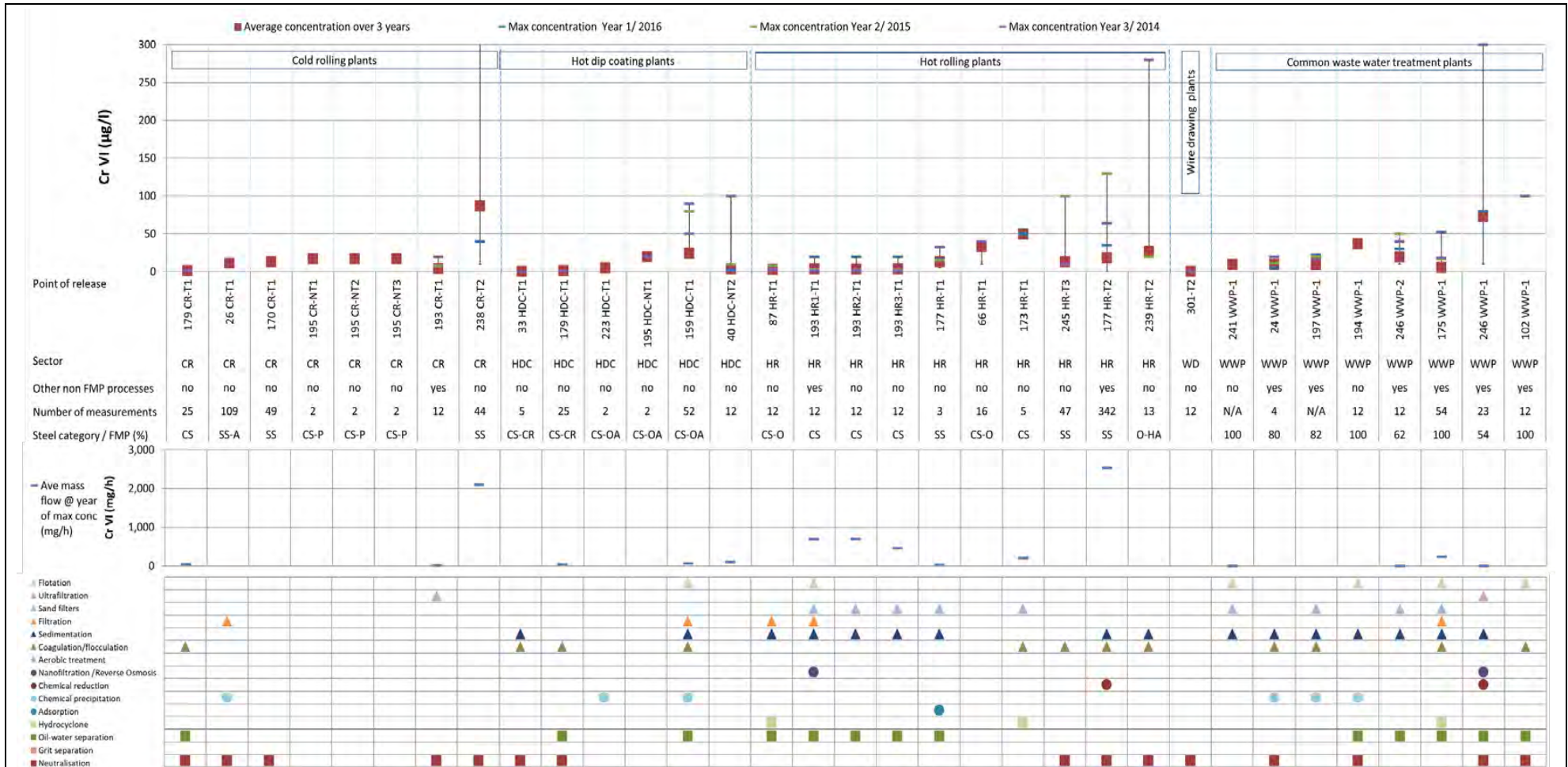


Values too high for the scale of the figure:

Plant code - Emission Point	Average concentration over 3 years (mg/l)	Max. concentration Year 1/2016 (mg/l)	Max. concentration Year 2/2015 (mg/l)	Max. concentration Year 3/2014 (mg/l)	Average mass flow at year of maximum concentration (g/h)
98 CR-T1					43.0
158 HR-T1	2.4	5.9			
266 HR-T1			6.7		

Source: [16. FMP TWG 2018]

Figure 7.13: Chromium emissions (in mg/l) for indirect discharges (sorted by steel category)



Values too high for the scale of the figure:

Plant code - Emission Point	Average concentration over 3 years (µg/l)	Max. concentration Year 1/2016 (µg/l)	Max. concentration Year 2/2015 (µg/l)	Max. concentration Year 3/2014 (µg/l)	Average mass flow at year of maximum concentration (mg/h)
197 WWP-1					180 286
245 HR-T3					30 324
238 CR-T2			2,800	930.0	
102 WWP-1	358.7	2,955	4,715		134 324

Source: [16, FMP TWG 2018]

Figure 7.14: Chromium VI emissions (in µg/l) for direct discharges

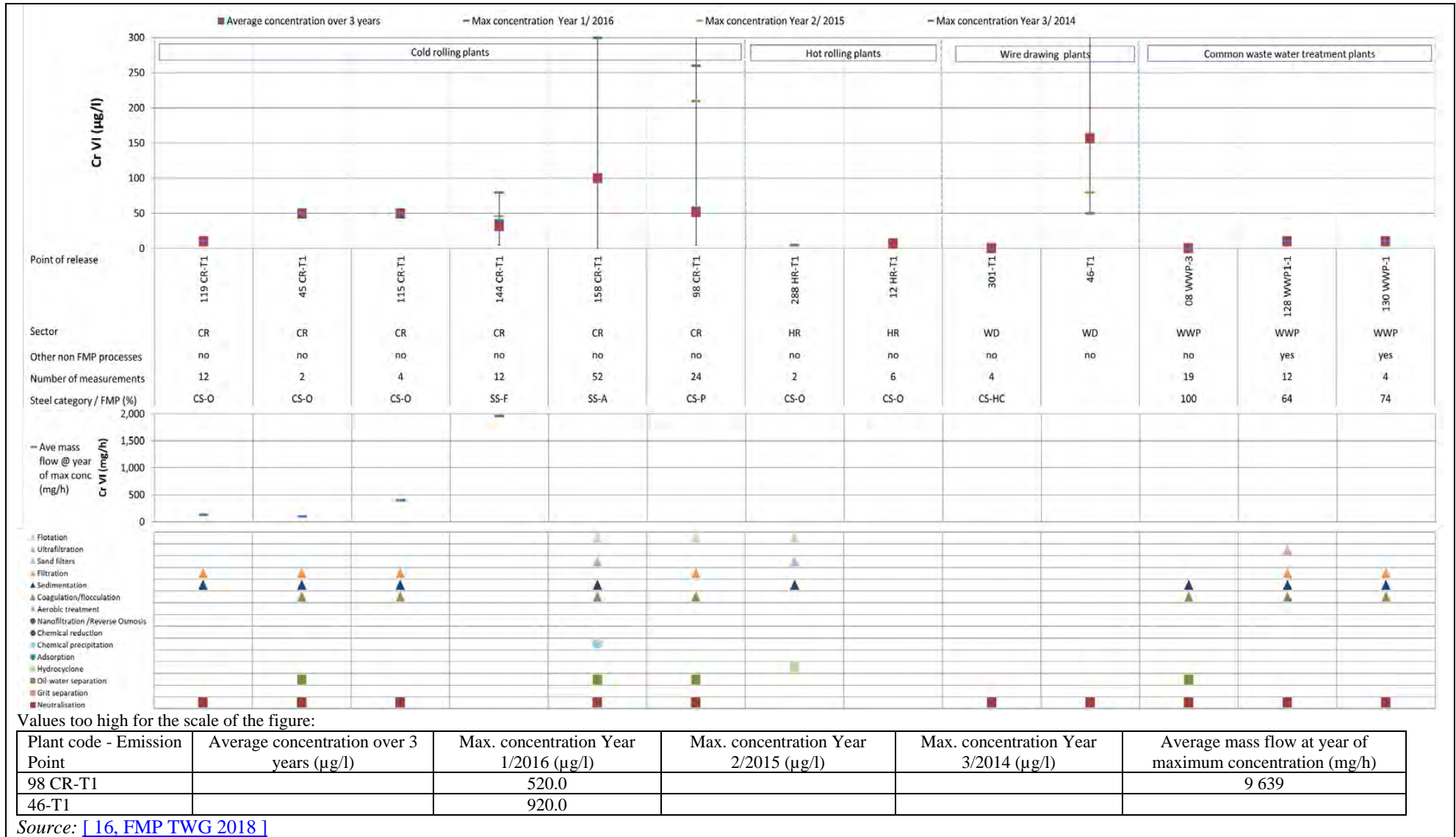


Figure 7.15: Chromium VI emissions (in µg/l) for indirect discharges



Figure 7.16: Fluoride emissions (in mg/l) for direct discharges



Figure 7.17: Fluoride emissions (in mg/l) for indirect discharges

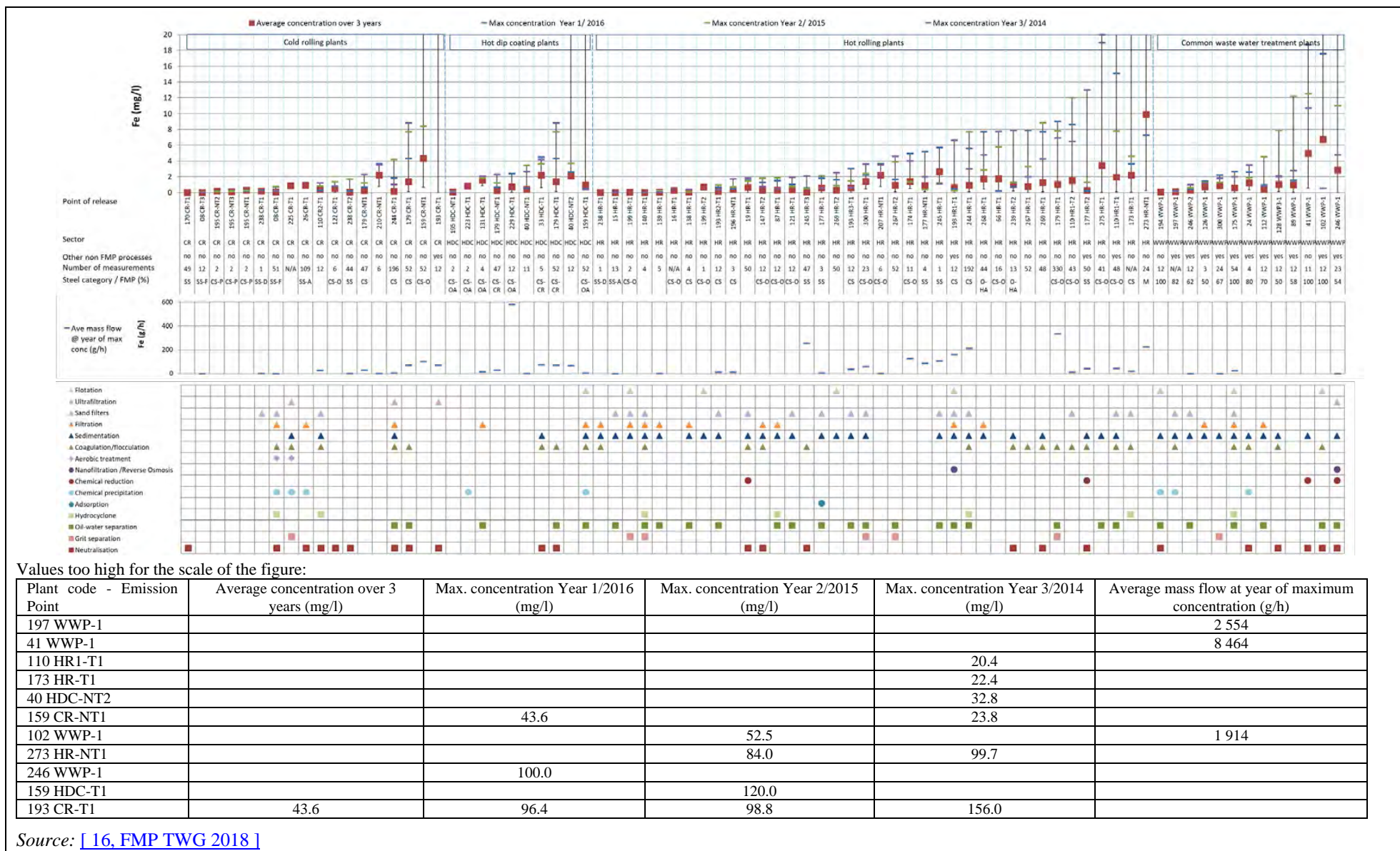


Figure 7.18: Iron emissions (in mg/l) for direct discharges

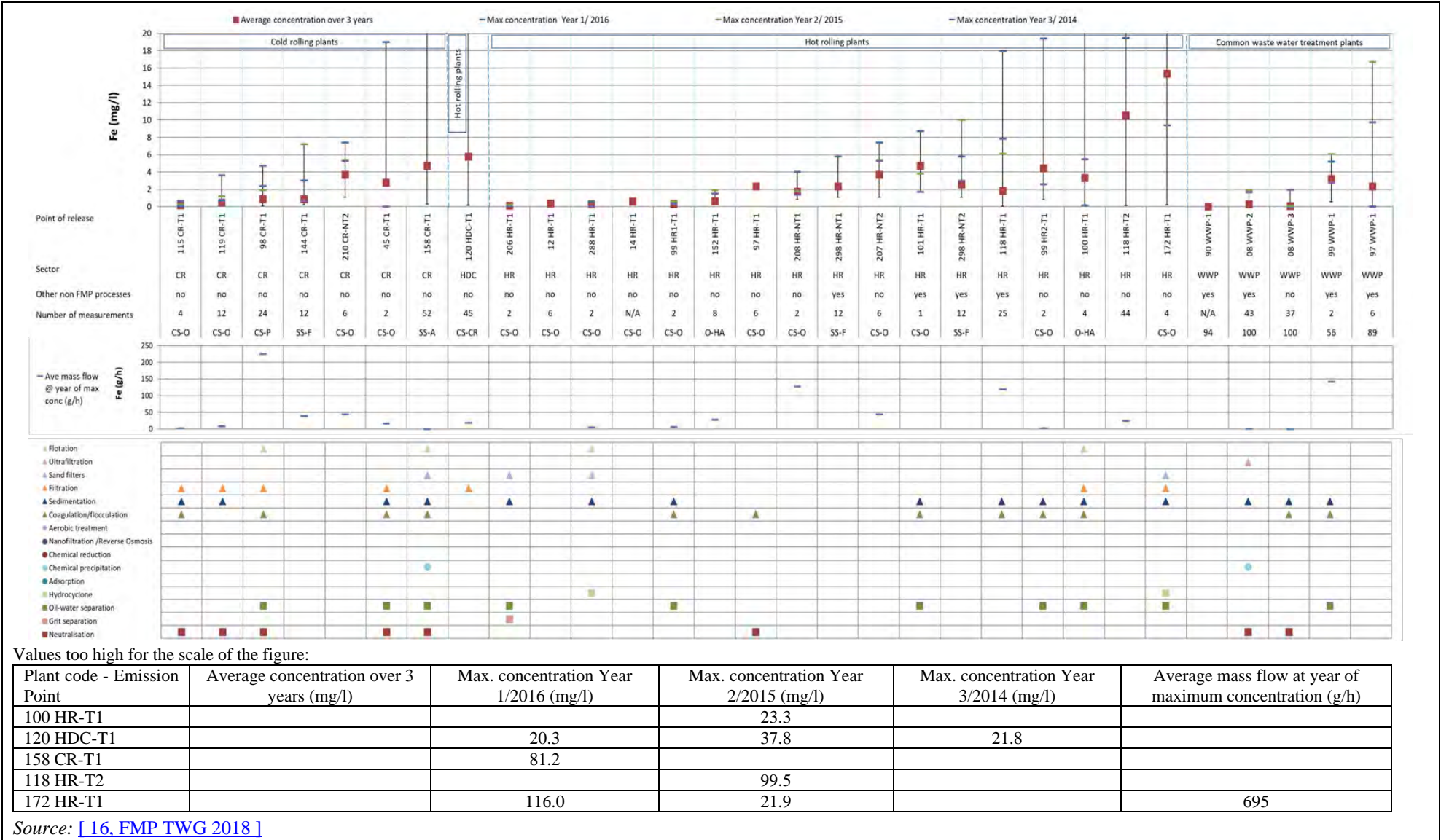
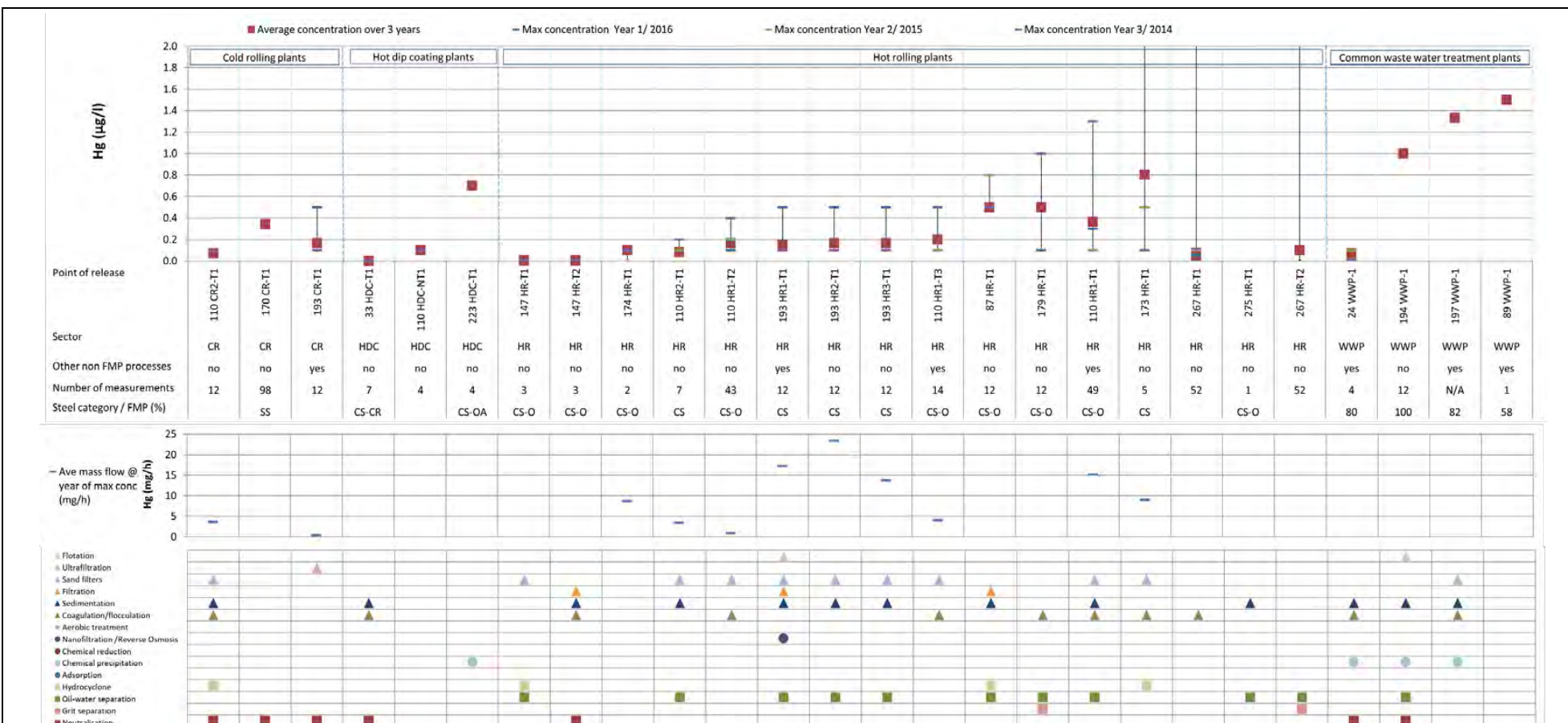


Figure 7.19: Iron emissions (in mg/l) for indirect discharges



Values too high for the scale of the figure:

Plant code - Emission Point	Average concentration over 3 years (µg/l)	Max. concentration Year 1/2016 (µg/l)	Max. concentration Year 2/2015 (µg/l)	Max. concentration Year 3/2014 (µg/l)	Average mass flow at year of maximum concentration (mg/h)
179 HR-T1					300.0
173 HR-T1		2.3			
267 HR-T1			2.5		
275 HR-T1	10.0	10.0	10.0	10.0	1 062
267 HR-T2		6.1	3.5	10.0	

Source: [16, FMP TWG 2018]

Figure 7.20: Mercury emissions (in µg/l) for direct discharges

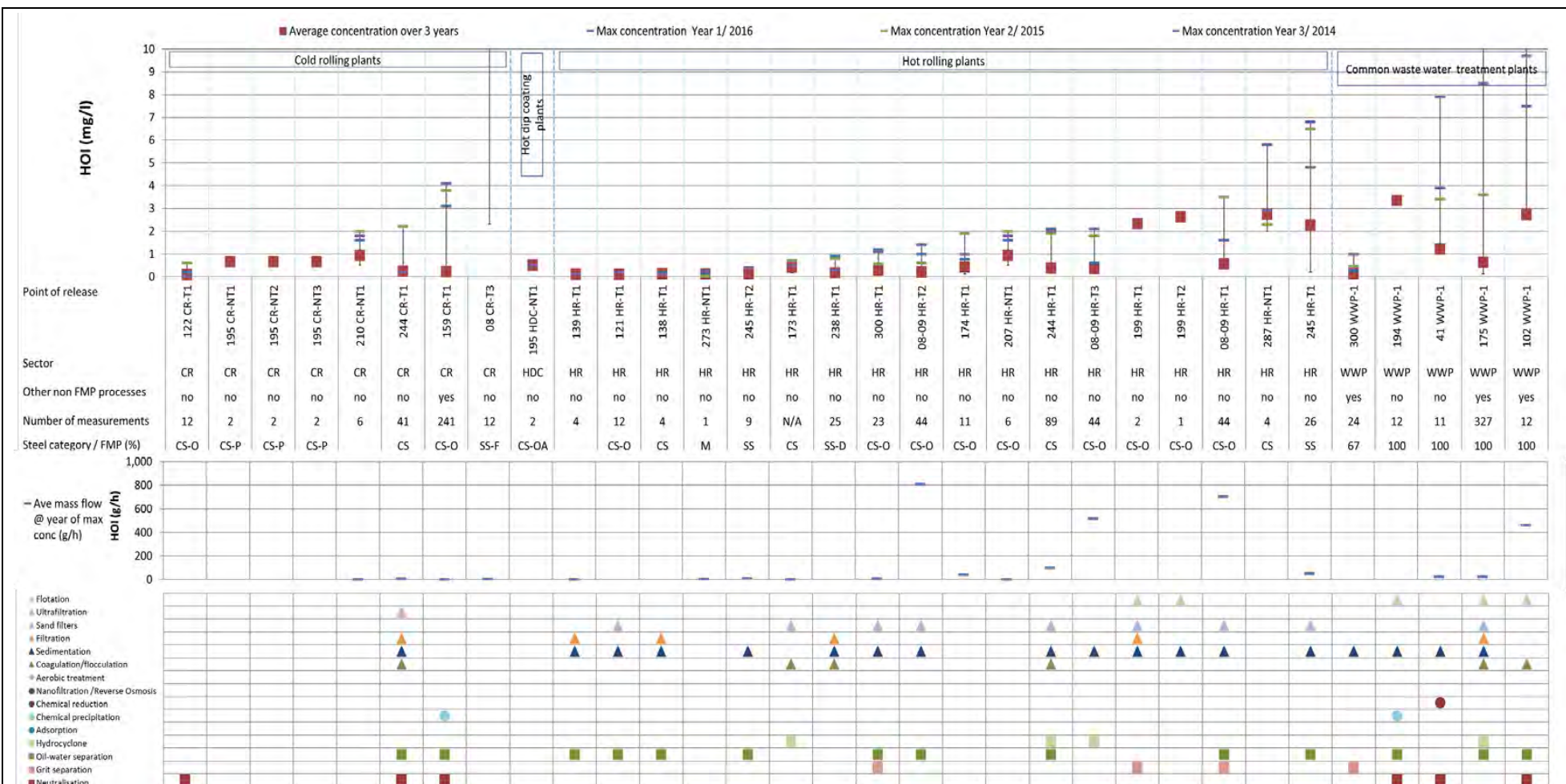


Values too high for the scale of the figure:

Plant code - Emission Point	Average concentration over 3 years (µg/l)	Max. concentration Year 1/2016 (µg/l)	Max. concentration Year 2/2015 (µg/l)	Max. concentration Year 3/2014 (µg/l)	Average mass flow at year of maximum concentration (mg/h)
97 HR-T1	10.0				
97 WWP-1	10.0		10.0	10.0	
172 HR-T1	5.5	5.0	20.0		90.0
45 CR-T1	25.0	25.0	25.0	25.0	50.0

Source: [16, FMP TWG 2018]

Figure 7.21: Mercury emissions (in µg/l) for indirect discharges



Values too high for the scale of the figure:

Plant code - Emission Point	Average concentration over 3 years (mg/l)	Max. concentration Year 1/2016 (mg/l)	Max. concentration Year 2/2015 (mg/l)	Max. concentration Year 3/2014 (mg/l)
102 WWP-1			18.5	
175 WWP-1		11.6		
08 CR-T3	11.6	16.1	19.3	18.0

Source: [16, FMP TWG 2018]

Figure 7.22: Hydrocarbon oil index emissions (in mg/l) for direct discharges

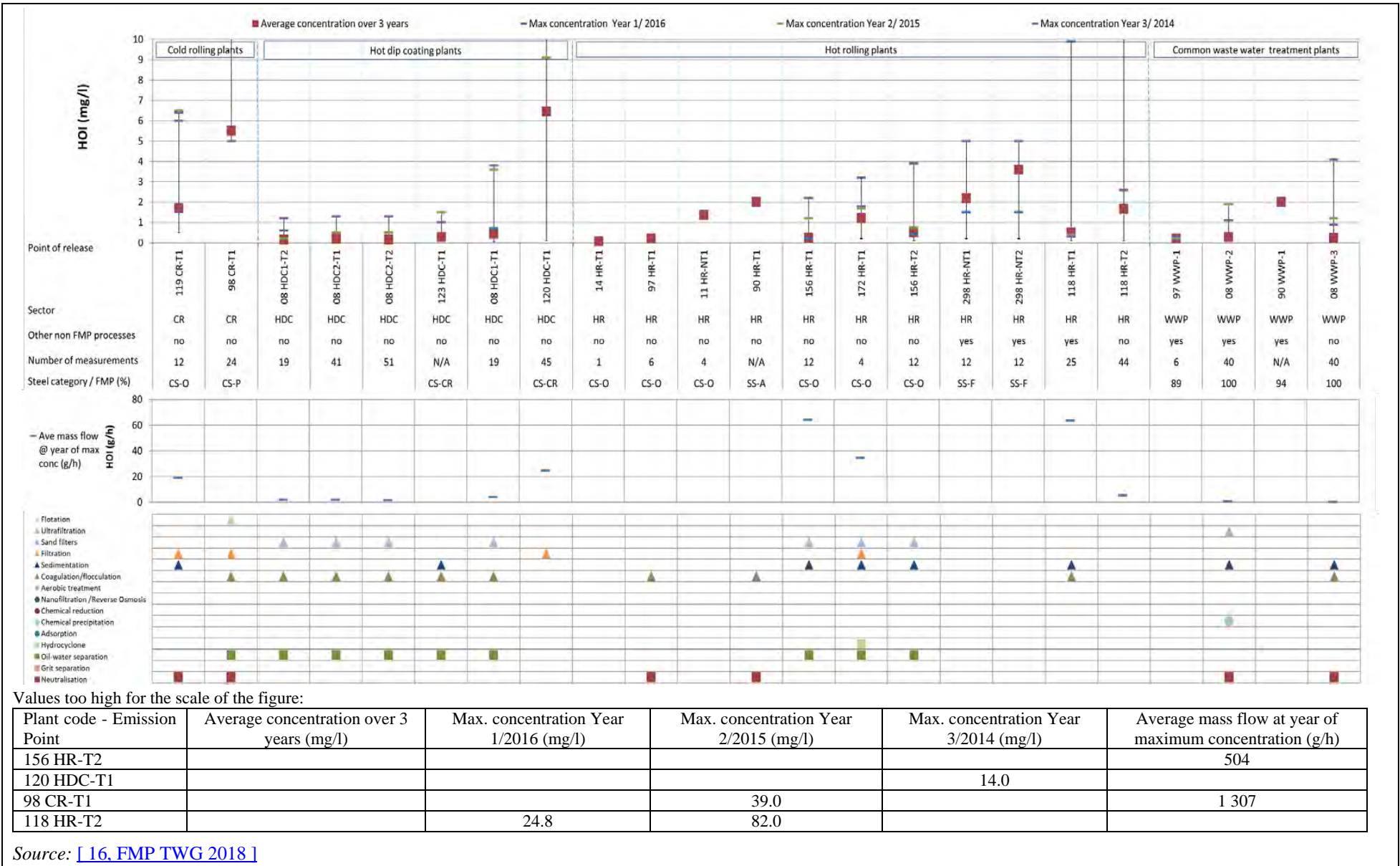
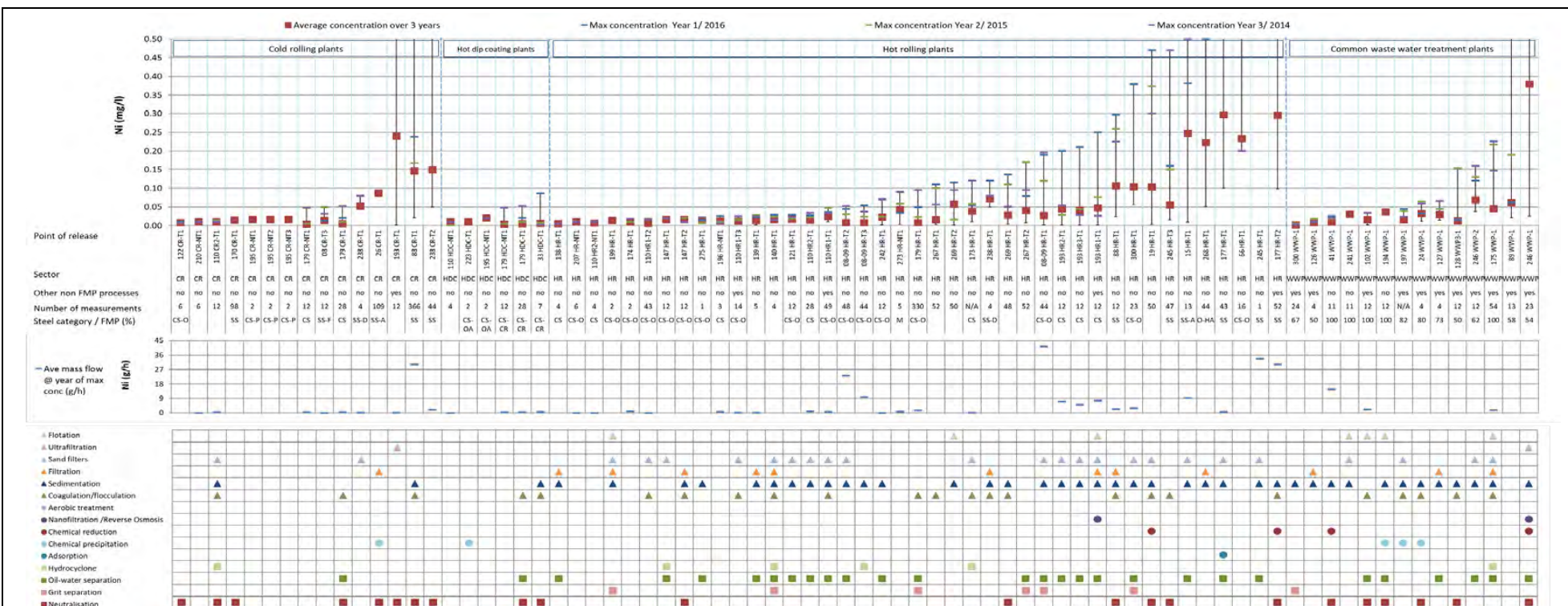


Figure 7.23: Hydrocarbon oil index emissions (in mg/l) for indirect discharges

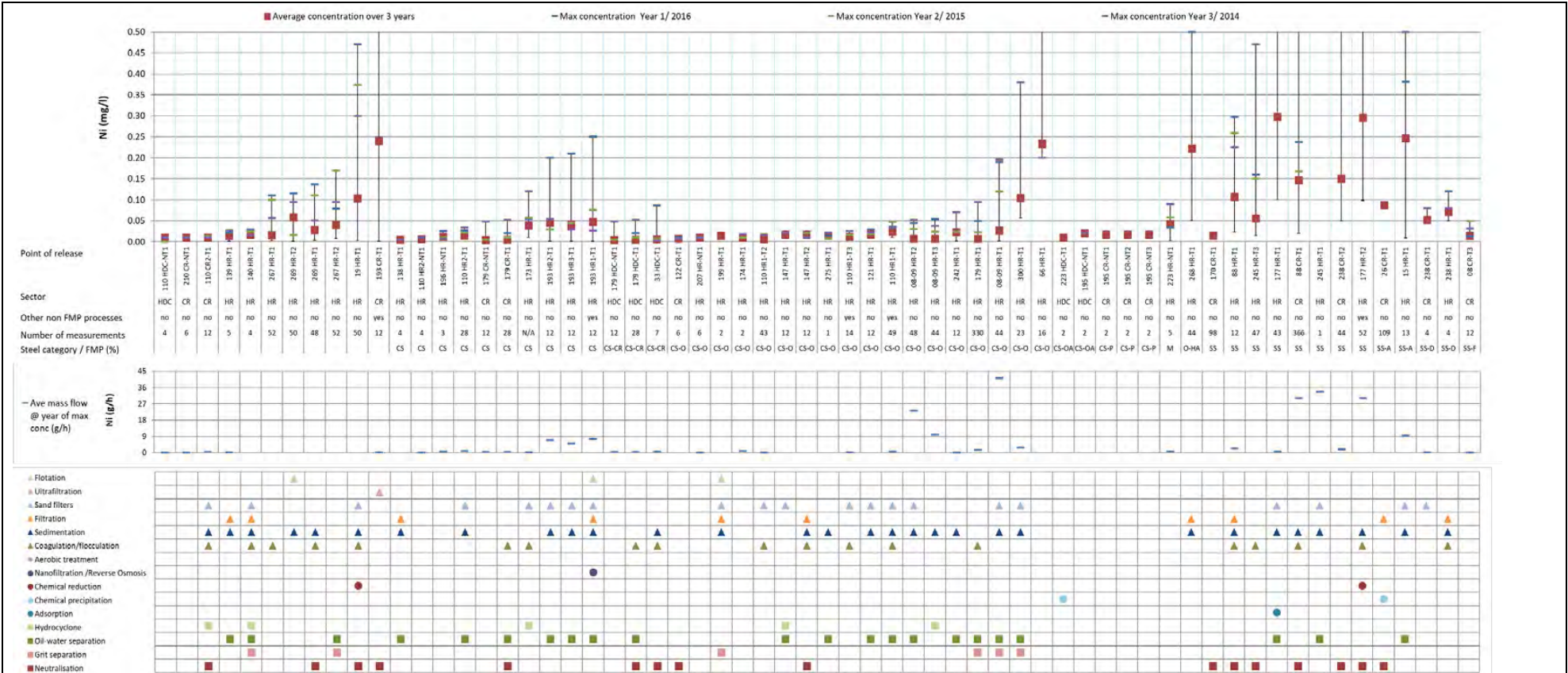


Values too high for the scale of the figure:

Plant code - Emission Point	Average concentration over 3 years (mg/l)	Max. concentration Year 1/2016 (mg/l)	Max. concentration Year 2/2015 (mg/l)	Max. concentration Year 3/2014 (mg/l)	Average mass flow at year of maximum concentration (g/h)
197 WWP-1					300.0
245 HR-T3					147.0
89 WWP-1				0.7	
193 CR-T1		0.7	0.8	0.7	
268 HR-T1			0.6	0.8	
177 HR-T1		0.7	0.7	0.9	
88 CR-T1				0.9	
66 HR-T1		1.6			
245 HR-T1	1.1	1.8	0.8	0.6	
238 CR-T2		1.6	3.2	1.0	
177 HR-T2		0.7	0.9	4.2	
246 WWP-1		5.1	1.2	1.2	

Source: [16, FMP TWG 2018]

Figure 7.24: Nickel emissions (in mg/l) for direct discharges

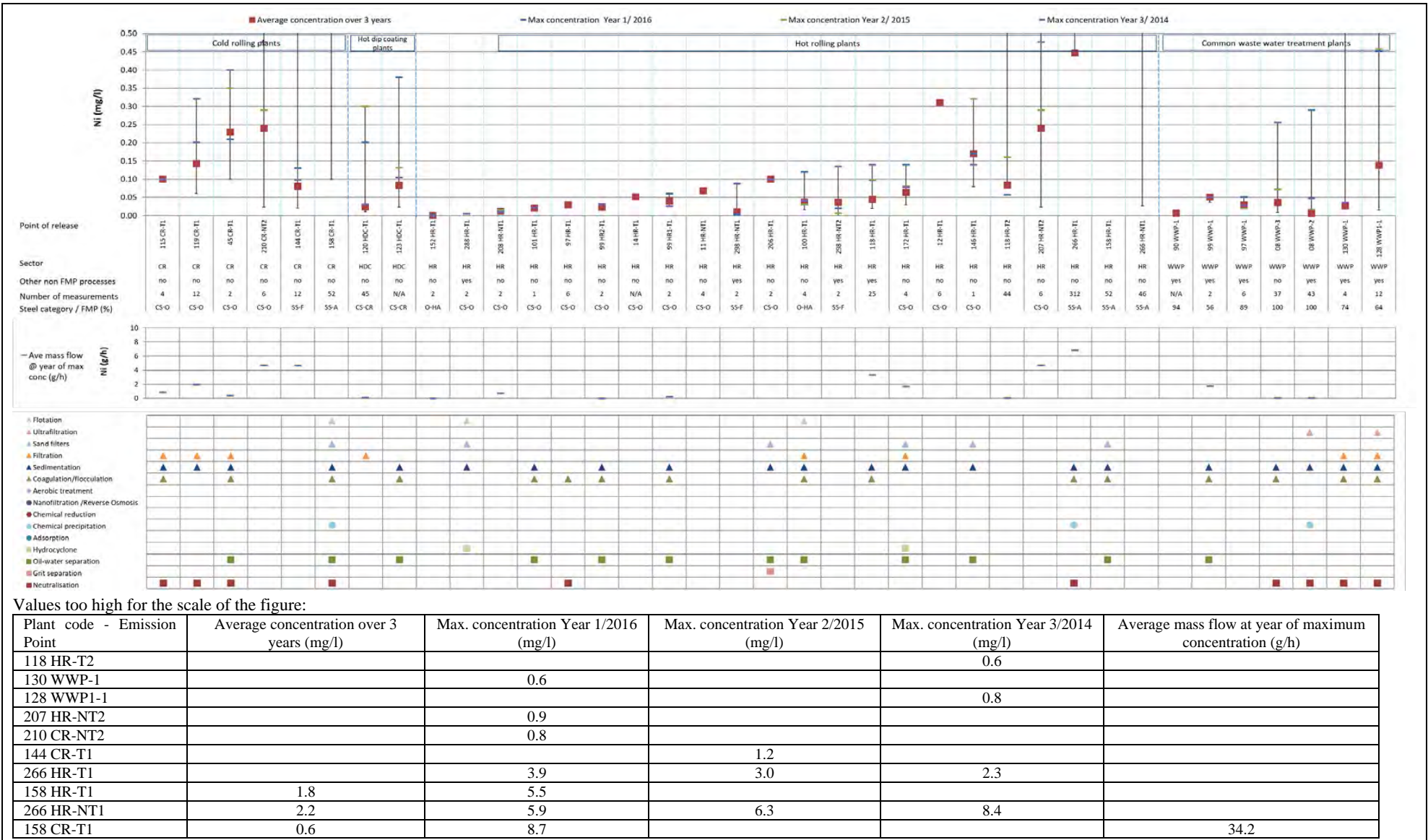


Values too high for the scale of the figure:

Plant code - Emission Point	Average concentration over 3 years (mg/l)	Max. concentration Year 1/2016 (mg/l)	Max. concentration Year 2/2015 (mg/l)	Max. concentration Year 3/2014 (mg/l)	Average mass flow at year of maximum concentration (g/h)
245 HR-T3					147.0
193 CR-T1		0.8	0.8	0.7	
268 HR-T1			0.6	0.8	
177 HR-T1		0.7	0.7	0.9	
88 CR-T1				0.9	
66 HR-T1		1.6			
245 HR-T1	1.1	1.8	0.8	0.6	
238 CR-T2		1.6	3.2	1.0	
177 HR-T2		0.7	0.9	4.2	

Source: [16, FMP TWG 2018]

Figure 7.25: Nickel emissions (in mg/l) for direct discharges (sorted by steel category)



Source: [16, FMP TWG 2018]

Figure 7.26: Nickel emissions (in mg/l) for indirect discharges



Values too high for the scale of the figure:

Plant code - Emission Point	Average concentration over 3 years (mg/l)	Max. concentration Year 1/2016 (mg/l)	Max. concentration Year 2/2015 (mg/l)	Max. concentration Year 3/2014 (mg/l)	Average mass flow at year of maximum concentration (g/h)
118 HR-T2				0.6	
207 HR-NT2		0.9			
210 CR-NT2		0.9			
144 CR-T1			1.2		
266 HR-T1		3.8	3.1	2.3	
158 HR-T1	1.8	5.5			
266 HR-NT1	2.2	5.9	6.3	8.4	
158 CR-T1	0.6	8.7			34.2

Source: [16, FMP TWG 2018]

Figure 7.27: Nickel emissions (in mg/l) for indirect discharges (sorted by steel category)

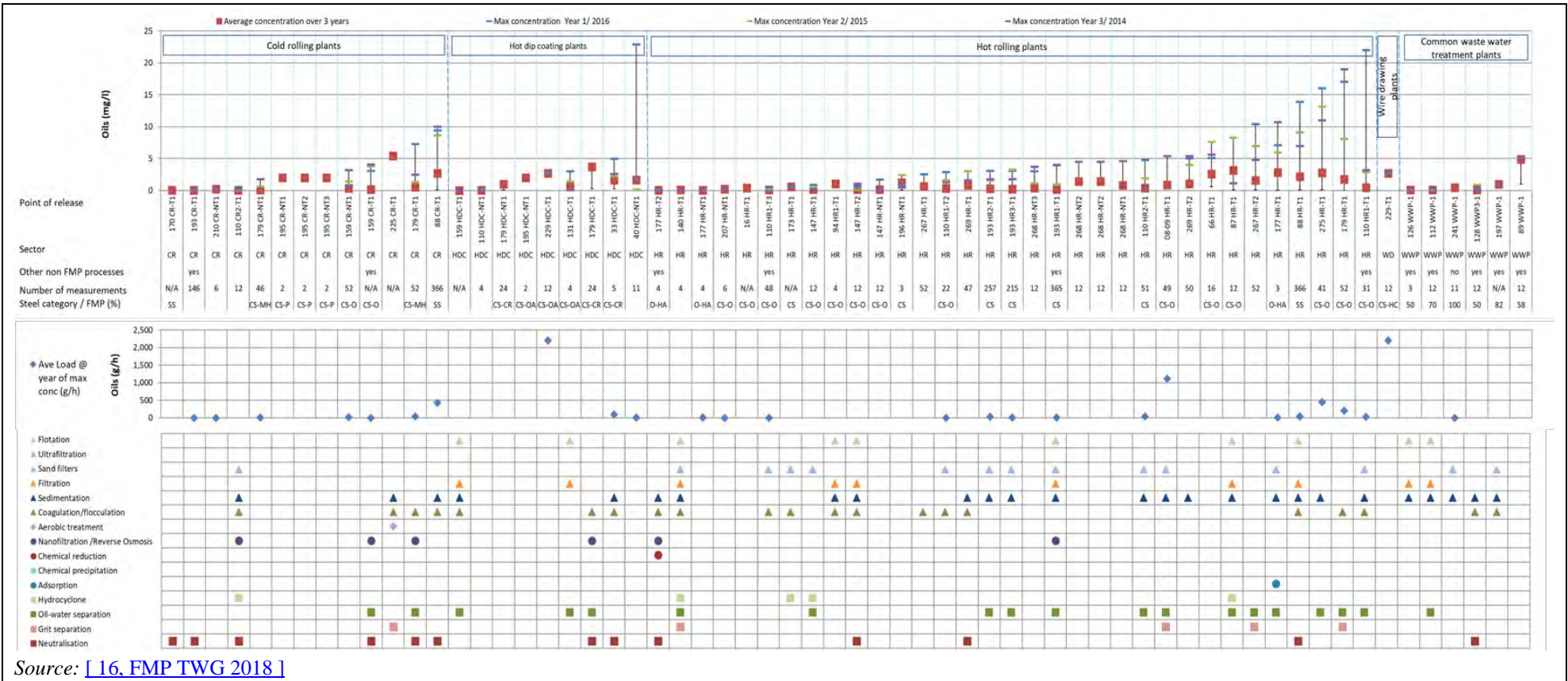
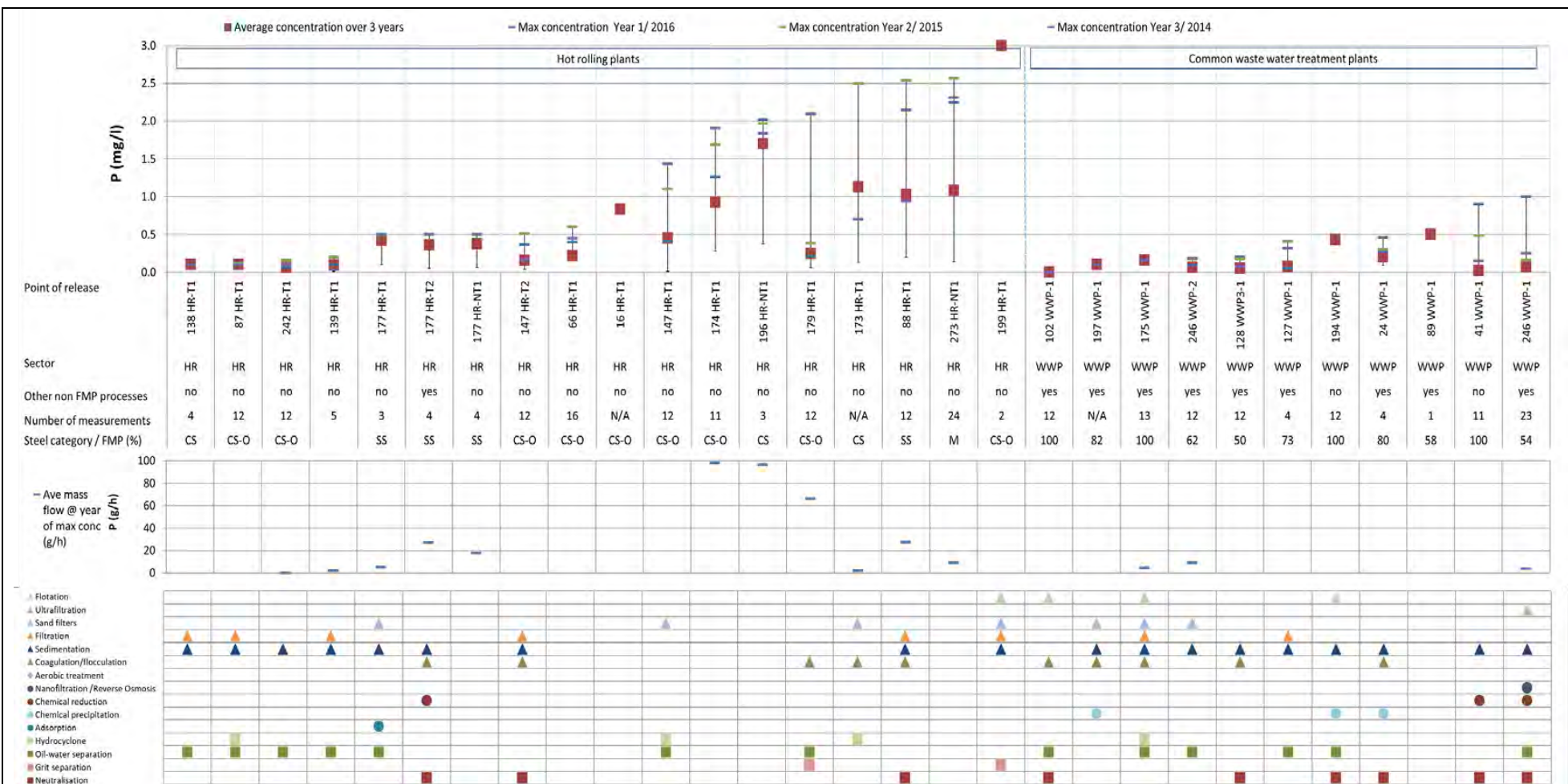


Figure 7.28: Oil emissions (in mg/l) for direct discharges



Source: [16, FMP TWG 2018]

Figure 7.29: Oil emissions (in mg/l) for indirect discharges



Values too high for the scale of the figure:

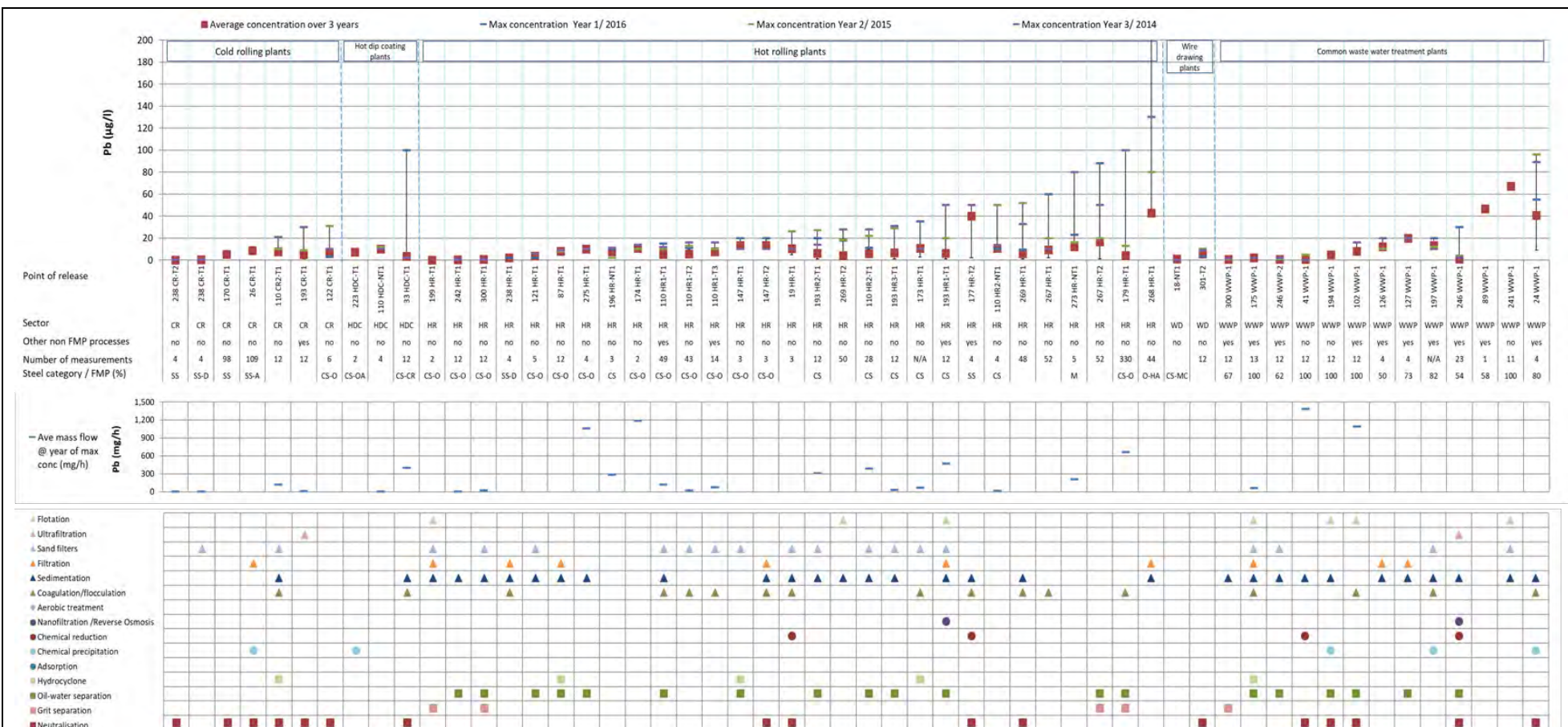
Plant code - Emission Point	Average concentration over 3 years (mg/l)	Max. concentration Year 1/2016 (mg/l)	Max. concentration Year 2/2015 (mg/l)	Max. concentration Year 3/2014 (mg/l)	Average mass flow at year of maximum concentration (g/h)
197 WWP-1					1 502.0

Source: [16, FMP TWG 2018]

Figure 7.30: Phosphorus emissions (in mg/l) for direct discharges



Figure 7.31: Phosphorus emissions (in mg/l) for indirect discharges

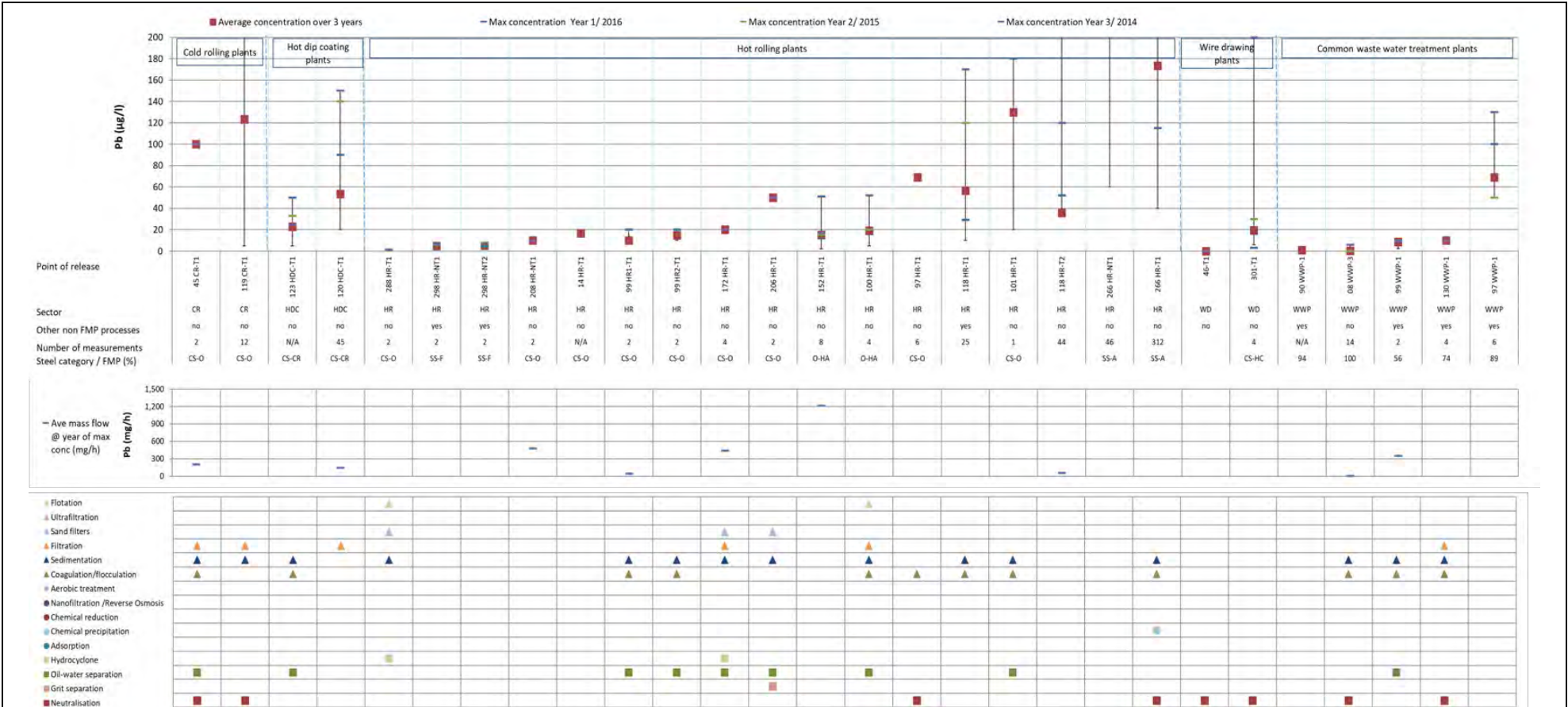


Values too high for the scale of the figure:

Plant code - Emission Point	Average concentration over 3 years (µg/l)	Max. concentration Year 1/2016 (µg/l)	Max. concentration Year 2/2015 (µg/l)	Max. concentration Year 3/2014 (µg/l)	Average mass flow at year of maximum concentration (mg/h)
197 WWP-1					300 477
177 HR-T2					29 000
268 HR-T1		590.0			

Source: [16. FMP TWG 2018]

Figure 7.32: Lead emissions (in µg/l) for direct discharges

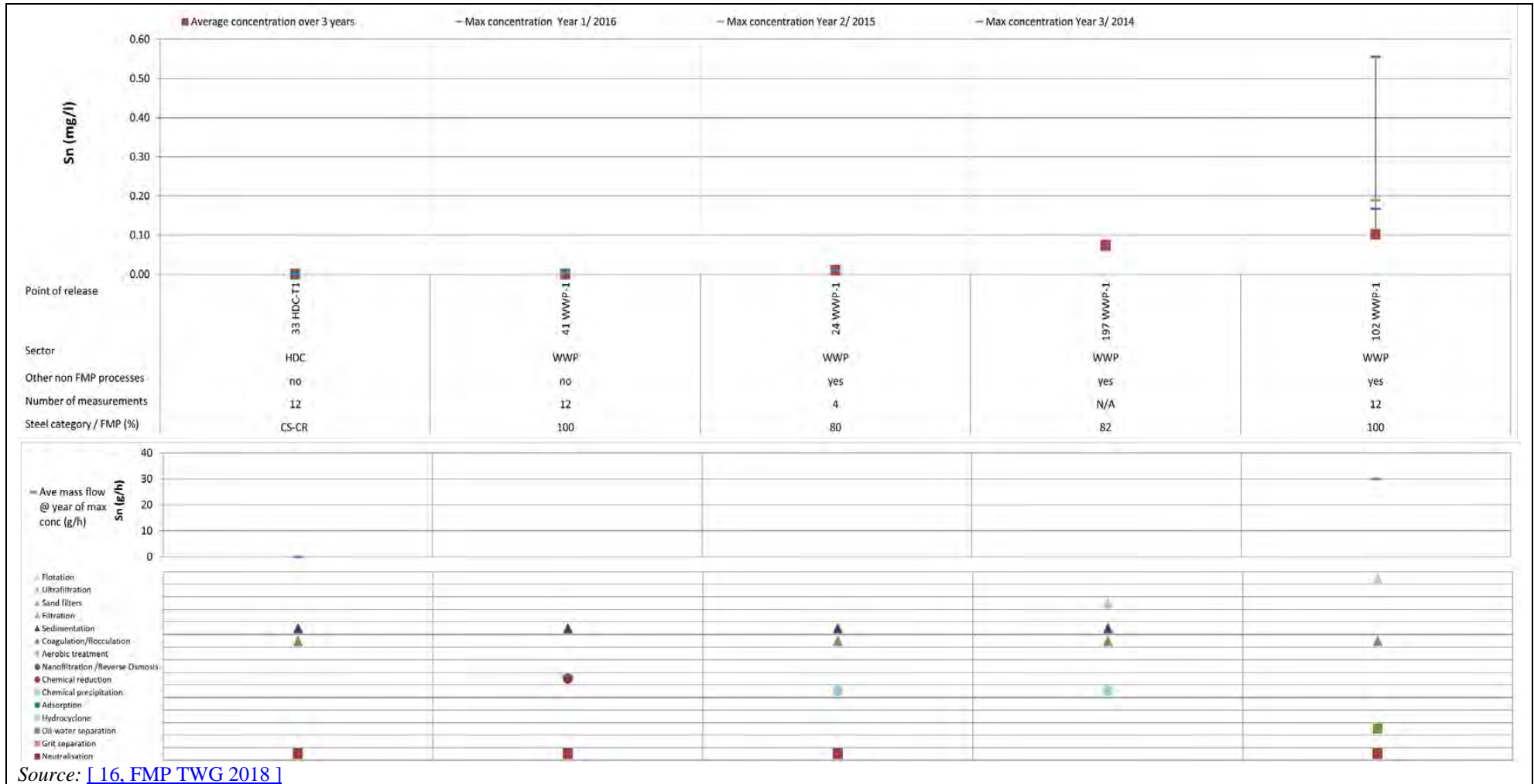


Values too high for the scale of the figure:

Plant code - Emission Point	Average concentration over 3 years (µg/l)	Max. concentration Year 1/2016 (µg/l)	Max. concentration Year 2/2015 (µg/l)	Max. concentration Year 3/2014 (µg/l)	Average mass flow at year of maximum concentration (mg/h)
118 HR-T1					5 400
119 CR-T1		370.0	220.0	640.0	1 560
266 HR-NT1		750.0			
266 HR-T1			529.0	1 188.0	3 457

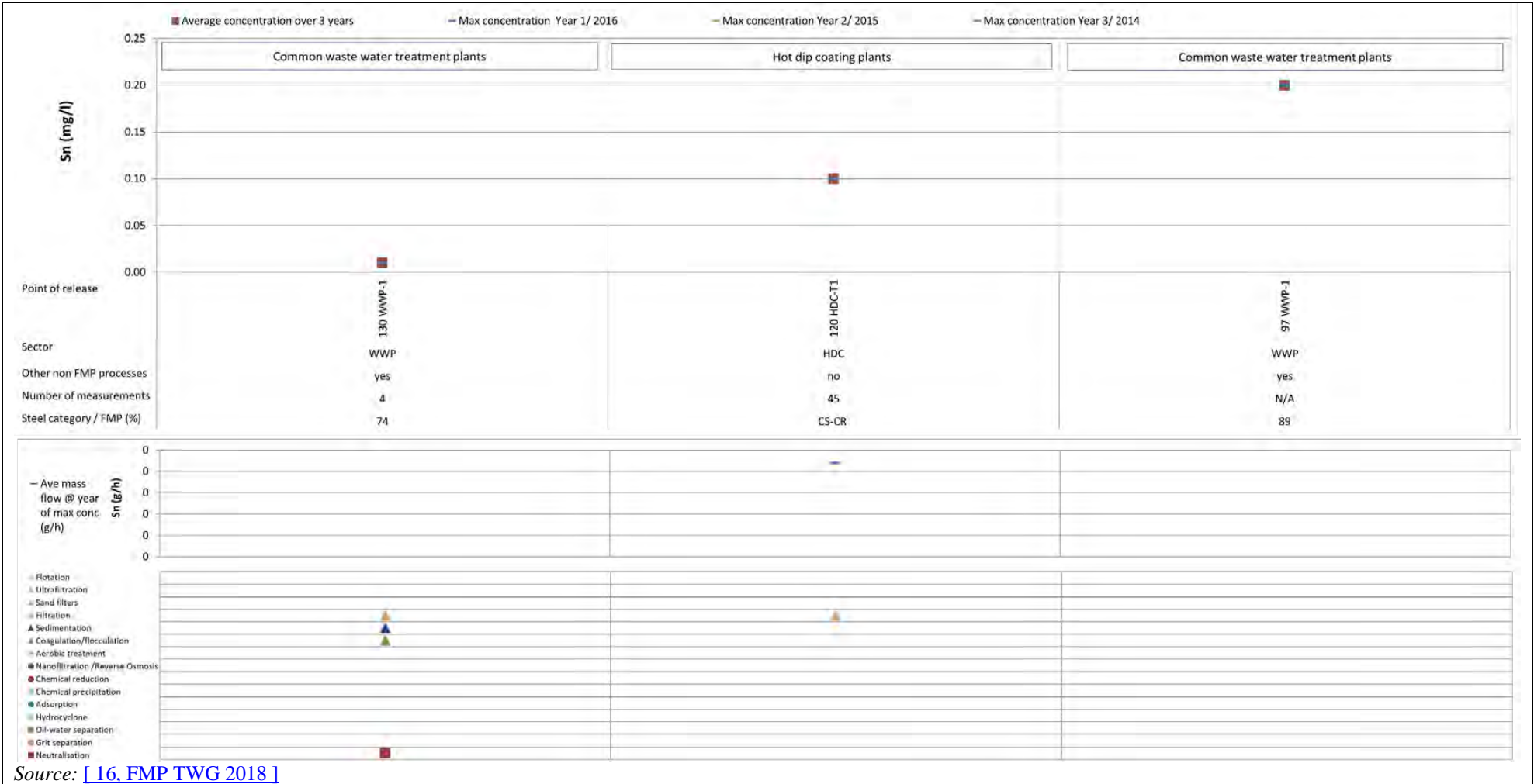
Source: [16, FMP TWG 2018]

Figure 7.33: Lead emissions (in µg/l) for indirect discharges



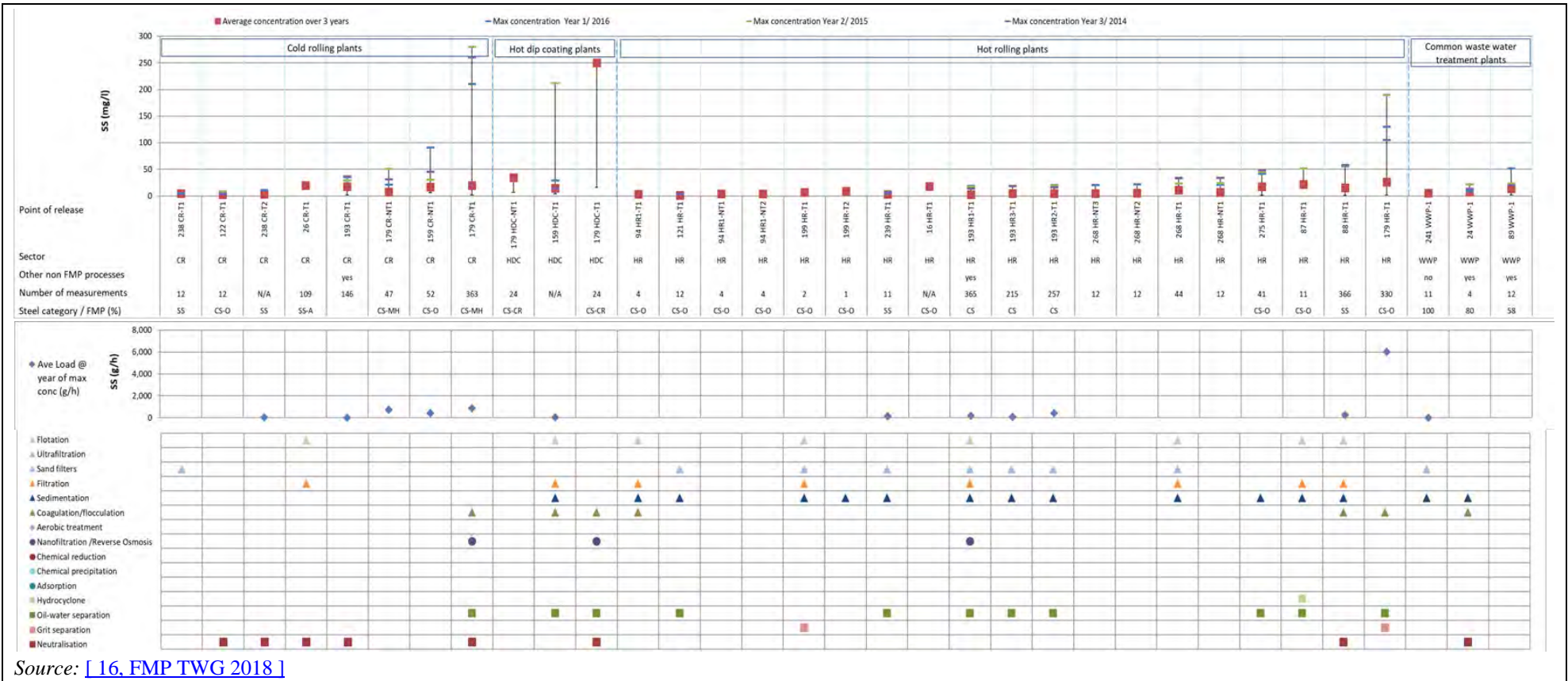
Source: [16, FMP TWG 2018]

Figure 7.34: Tin emissions (in mg/l) for direct discharges



Source: [16. FMP TWG 2018]

Figure 7.35: Tin emissions (in mg/l) for indirect discharges



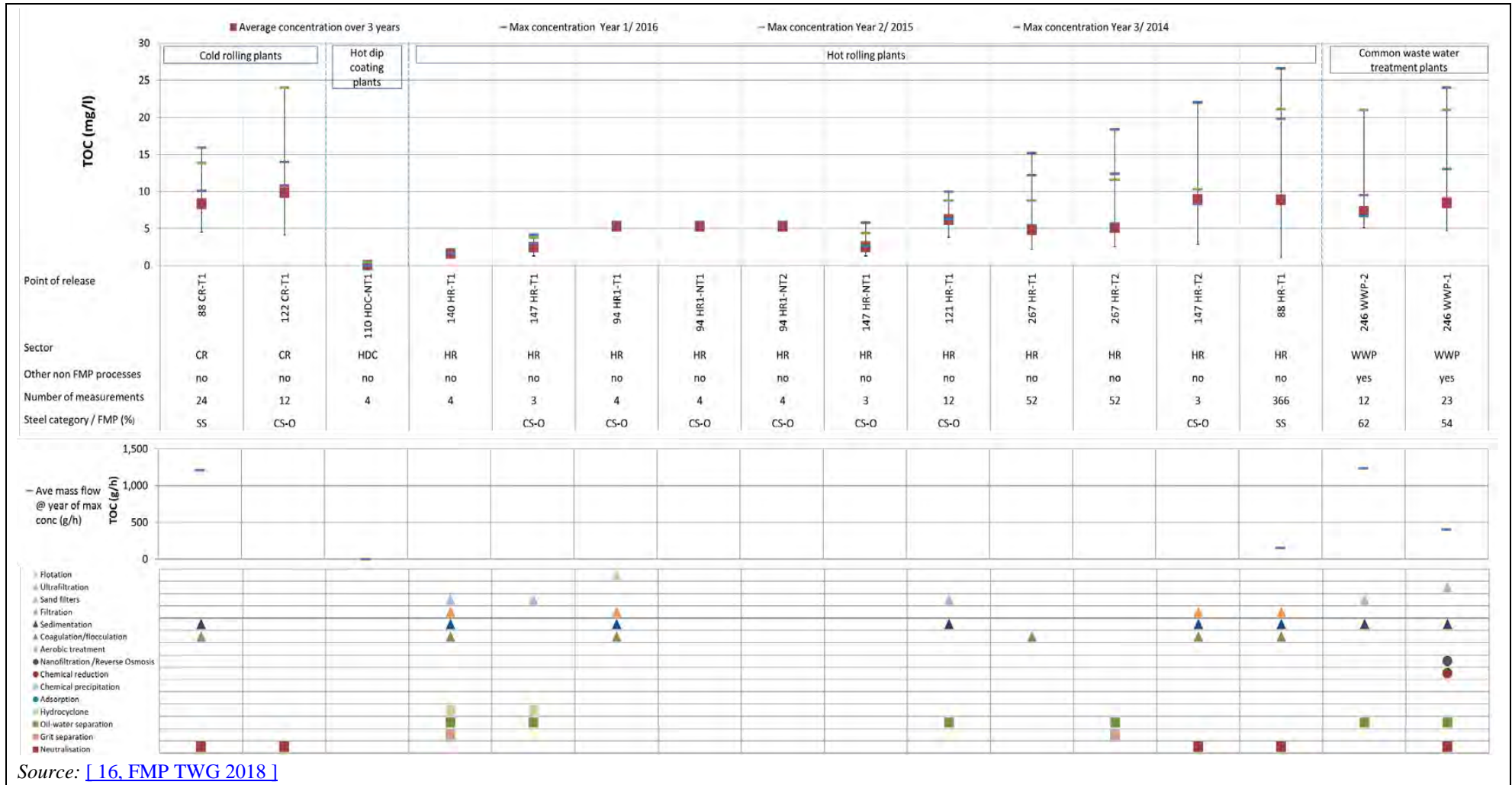
Source: [16, FMP TWG 2018]

Figure 7.36: Suspended solid emissions (in mg/l) for direct discharges



Source: [16, FMP TWG 2018]

Figure 7.37: Suspended solid emissions (in mg/l) for indirect discharges



Source: [16, FMP TWG 2018]

Figure 7.38: TOC emissions (in mg/l) for direct discharges



Figure 7.39: TOC emissions (in mg/l) for indirect discharges

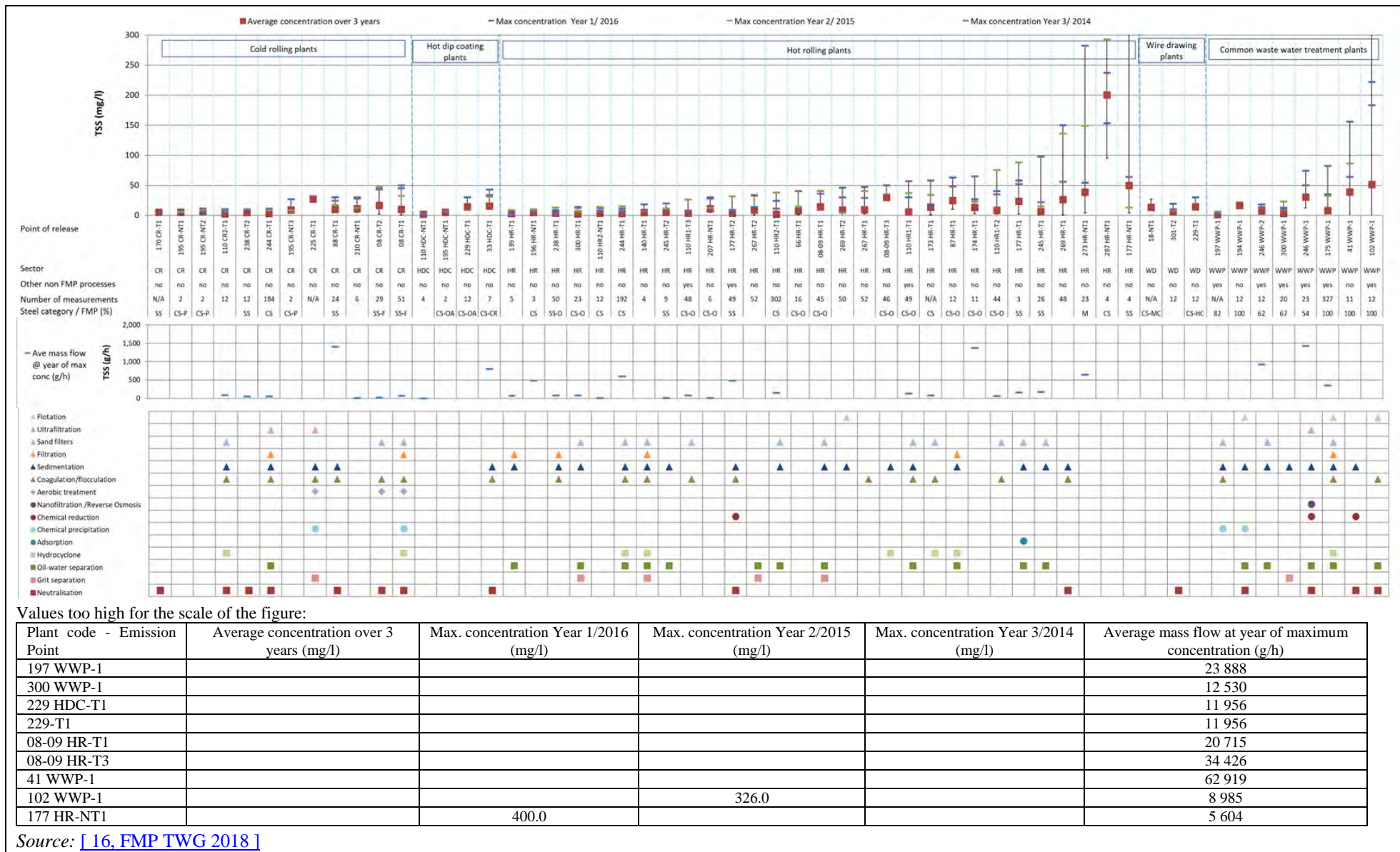


Figure 7.40: Total suspended solid emissions (in mg/l) for direct discharges

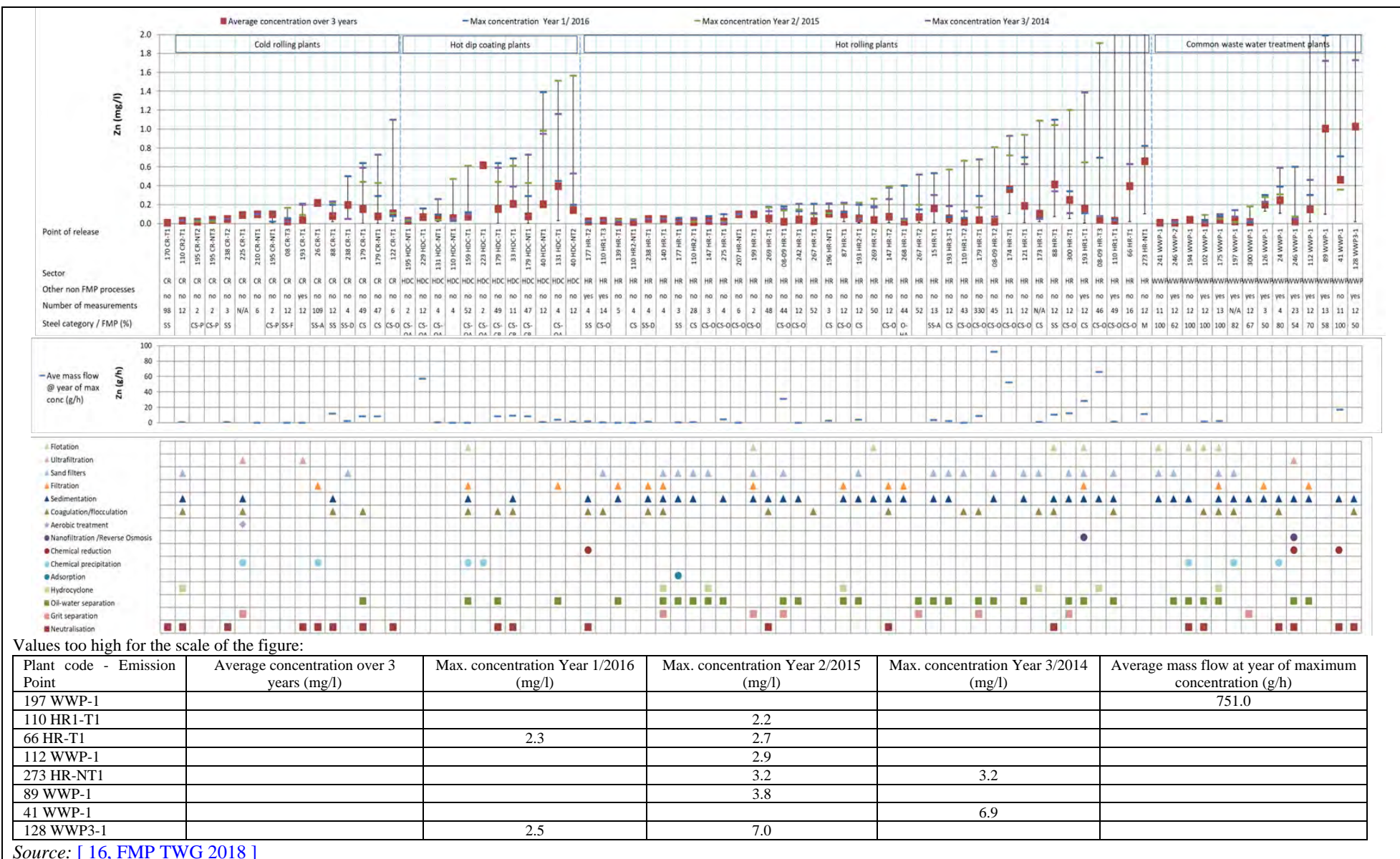


Figure 7.42: Zinc emissions (in mg/l) for direct discharges

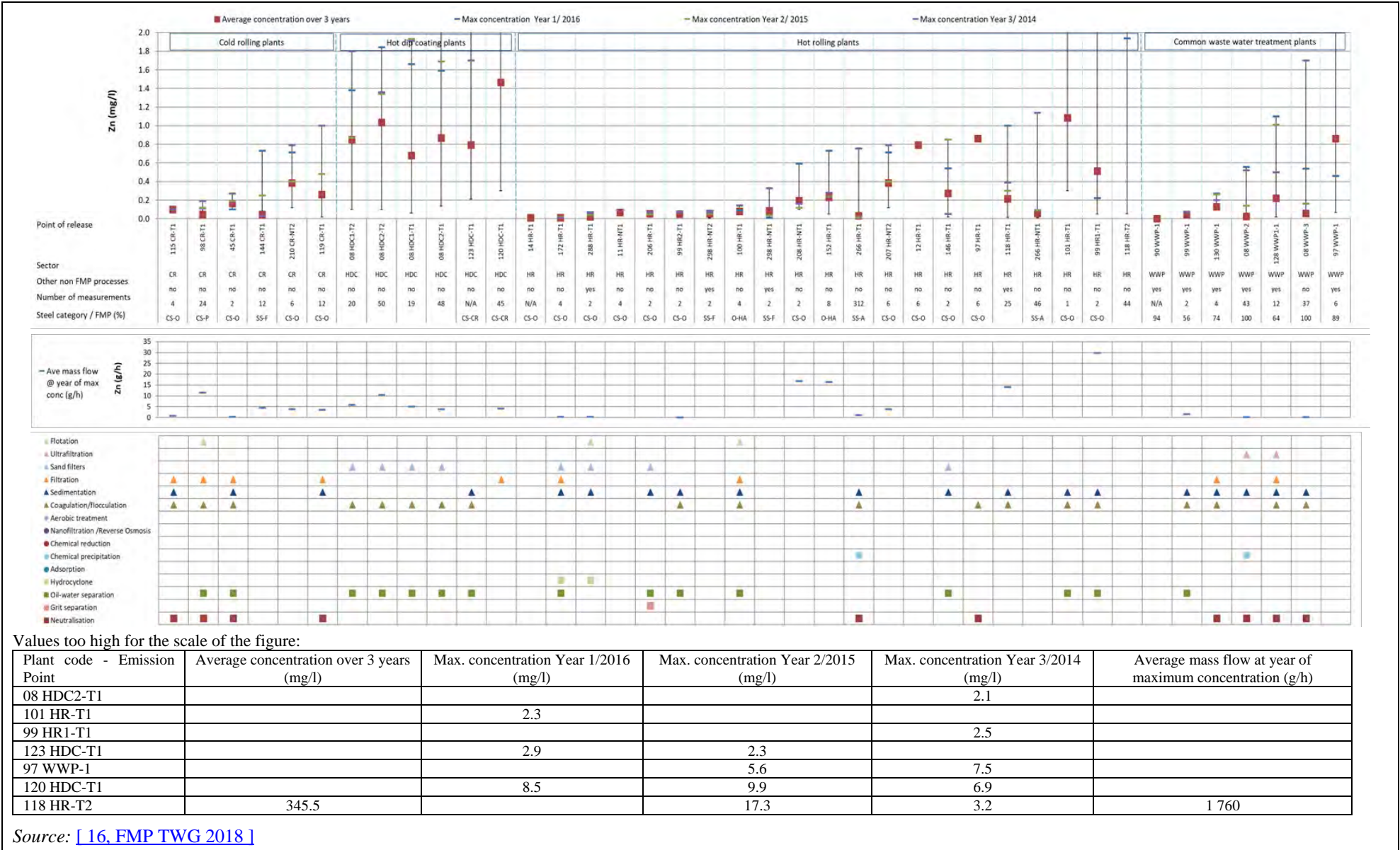


Figure 7.43: Zinc emissions (in mg/l) for indirect discharges

8 TECHNIQUES TO CONSIDER IN THE DETERMINATION OF BAT IN MORE THAN ONE SECTOR

In order to avoid repetition in describing certain techniques considered in the determination of BAT, this section contains techniques which are used in several sectors. In this section, a general description of the techniques is provided. Sector-specific aspects of the techniques (main achieved environmental benefits, applicability, cross-media effects, reference plants, operational data, economics, driving force for implementation and reference literature), if any, are sometimes further covered in the relevant Chapters 2 to 6 of this document, in which cross-references to Chapter 8 are included where relevant.

8.1 Environmental management techniques

8.1.1 Environmental management system (EMS)

Description

A formal system to demonstrate compliance with environmental objectives.

Technical description

The Industrial Emissions Directive defines ‘techniques’ (under the definition of ‘best available techniques’) as ‘both the technology used and the way in which the installation is designed, built, maintained, operated and decommissioned’.

In this respect, an environmental management system (EMS) is a technique allowing operators of installations to address environmental issues in a systematic and demonstrable way. EMSs are most effective and efficient where they form an inherent part of the overall management and operation of an installation.

An EMS focuses the attention of the operator on the environmental performance of the installation; in particular through the application of clear operating procedures for both normal and other than normal operating conditions, and by setting out the associated lines of responsibility.

All effective EMSs incorporate the concept of continuous improvement, meaning that environmental management is an ongoing process, not a project which eventually comes to an end. There are various process designs, but most EMSs are based on the plan-do-check-act cycle (which is widely used in other company management contexts). The cycle is an iterative dynamic model, where the completion of one cycle flows into the beginning of the next (see Figure 8.1).

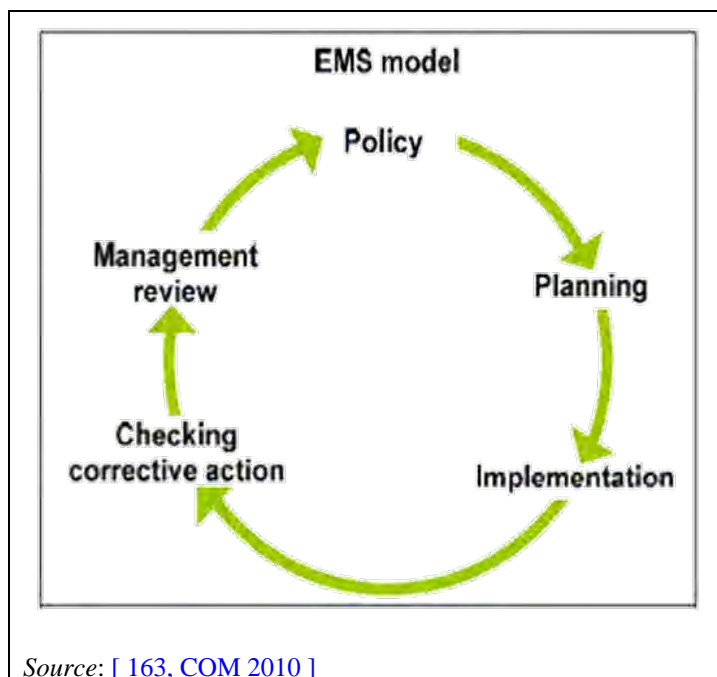


Figure 8.1: Continuous improvement in an EMS model

An EMS can take the form of a standardised or non-standardised ('customised') system. Implementation and adherence to an internationally accepted standardised system, such as EN ISO 14001:2015, can give higher credibility to the EMS especially when subjected to a properly performed external verification. The European Union eco-management and audit scheme (EMAS) according to Regulation (EC) No 1221/2009 provides additional credibility due to the interaction with the public through the environmental statement and the mechanism to ensure compliance with the applicable environmental legislation. However, non-standardised systems can, in principle, be equally effective provided that they are properly designed and implemented.

While both standardised systems (EN ISO 14001:2015 or EMAS) and non-standardised systems apply in principle to organisations, this document takes a narrower approach, not including all activities of an organisation, e.g. with regard to their products and services, due to the fact that the Directive only regulates installations.

An EMS can contain the following features:

- i. commitment, leadership, and accountability of the management, including senior management, for the implementation of an effective EMS;
- ii. an analysis that includes the determination of the organisation's context, the identification of the needs and expectations of interested parties, the identification of characteristics of the installation that are associated with possible risks for the environment (or human health) as well as of the applicable legal requirements relating to the environment;
- iii. development of an environmental policy that includes the continuous improvement of the environmental performance of the installation;
- iv. establishing objectives and performance indicators in relation to significant environmental aspects, including safeguarding compliance with applicable legal requirements;
- v. planning and implementing the necessary procedures and actions (including corrective and preventive actions where needed), to achieve the environmental objectives and avoid environmental risks;
- vi. determination of structures, roles and responsibilities in relation to environmental aspects and objectives and provision of the financial and human resources needed;

- vii. ensuring the necessary competence and awareness of staff whose work may affect the environmental performance of the installation (e.g. by providing information and training);
- viii. internal and external communication;
- ix. fostering employee involvement in good environmental management practices;
- x. establishing and maintaining a management manual and written procedures to control activities with significant environmental impact as well as relevant records;
- xi. effective operational planning and process control;
- xii. implementation of appropriate maintenance programmes;
- xiii. emergency preparedness and response protocols, including the prevention and/or mitigation of the adverse (environmental) impacts of emergency situations;
- xiv. when (re)designing a (new) installation or a part thereof, consideration of its environmental impacts throughout its life, which includes construction, maintenance, operation and decommissioning;
- xv. implementation of a monitoring and measurement programme; if necessary, information can be found in the Reference Report on Monitoring of Emissions to Air and Water from IED Installations;
- xvi. application of sectoral benchmarking on a regular basis;
- xvii. periodic independent (as far as practicable) internal auditing and periodic independent external auditing in order to assess the environmental performance and to determine whether or not the EMS conforms to planned arrangements and has been properly implemented and maintained;
- xviii. evaluation of causes of nonconformities, implementation of corrective actions in response to nonconformities, review of the effectiveness of corrective actions, and determination of whether similar nonconformities exist or could potentially occur;
- xix. periodic review, by senior management, of the EMS and its continuing suitability, adequacy and effectiveness;
- xx. following and taking into account the development of cleaner techniques.

Specifically for the ferrous metals processing sector, the following features are included in the EMS:

- xxi. an inventory of process chemicals used and of waste water and waste gas streams (see Section 8.1.2)
- xxii. a chemicals management system (see Section 8.1.3);
- xxiii. a plan for the prevention and control of leaks and spillages (see Section 8.3.3);
- xxiv. an OTNOC management plan (see Section 8.3.5);
- xxv. an energy efficiency plan (see Section 8.5.1);
- xxvi. a water management plan (see Section 8.7.1);
- xxvii. a noise and vibrations management plan (see Section 8.10.1).
- xxviii. a residues management plan (see Section 8.11.1);

Achieved environmental benefits

An EMS promotes and supports the continuous improvement of the environmental performance of the installation. If the installation already has a good overall environmental performance, an EMS helps the operator to maintain the high performance level.

Cross-media effects

None reported. The systematic analysis of the initial environmental impacts and scope for improvements in the context of the EMS sets the basis for assessing the best solutions for all environmental media.

Technical considerations relevant to applicability

The level of detail and the degree of formalisation of the EMS will generally be related to the nature, scale and complexity of the installation, and the range of environmental impacts it may have.

Economics

It is difficult to accurately determine the costs and economic benefits of introducing and maintaining a good EMS. There are also economic benefits that are the result of using an EMS and these vary widely from sector to sector.

Driving force for implementation

The driving forces for the implementation of an EMS include:

- improved environmental performance;
- improved insight into the environmental aspects of the company which can be used to fulfil the environmental requirements of customers, regulatory authorities, banks, insurance companies or other stakeholders (e.g. people living or working in the vicinity of the installation);
- improved basis for decision-making;
- improved motivation of personnel (e.g. managers can have confidence that environmental impacts are controlled and employees can feel that they are working for an environmentally responsible company);
- additional opportunities for operational cost reduction and product quality improvement;
- improved company image;
- reduced liability, insurance and non-compliance costs.

Example plants

EMSs are applied in a number of installations throughout the EU.

Reference literature

[\[163, COM 2010 \]](#), [\[164, IAF 2010 \]](#), [\[165, EU 2009 \]](#), [\[166, CEN 2015 \]](#).

8.1.2 Inventory of process chemicals used and of waste water and waste gas streams

Description

The compilation of relevant basic data on the process chemicals used and on the composition and quantity of waste water and waste gas streams – each one individually – is done in a stream inventory (register). The emitted streams are listed respective to their source (i.e. process) from which they originate. This is a key element in assessing their degree of contamination and the nature of the contaminants, as well as the possibilities of reduction at the source.

Technical description

A stream inventory (register) addresses the following aspects, if relevant to the particular local conditions:

- (i) information about the production processes, including:
 - (a) simplified process flow sheets that show the origin of the emissions;
 - (b) descriptions of process-integrated techniques and waste water/waste gas treatment at source including their performances;
- (ii) information about the characteristics of the waste water streams, such as:
 - (a) average values and variability of flow, pH, temperature, and conductivity;
 - (b) average concentration and mass flow values of relevant substances and their variability (e.g. total suspended solids, COD/TOC, hydrocarbon index, phosphorus, metals, fluorides);
- (iii) information about the quantity and characteristics of the process chemicals used:
 - (a) the identity and the characteristics of process chemicals, including properties with adverse effects on the environment and/or human health;
 - (b) the quantities of process chemicals used and the location of their use;

- (iv) information about the characteristics of the waste gas streams, such as:
 - (a) average values and variability of flow and temperature;
 - (b) average concentration and mass flow values of relevant substances and their variability (e.g. dust, NO_x, SO₂, CO, metals, acids);
 - (c) presence of other substances that may affect the waste gas treatment system (e.g. oxygen, nitrogen, water vapour) or plant safety (e.g. hydrogen).

Concerning the inventory of process chemicals, developing and maintaining such an inventory in an electronic format is preferable.

Achieved environmental benefits

Achieved environmental benefits include the reduction of emissions to water and/or air. Identification of relevant waste water/waste gas streams is a prerequisite for efficient waste water/waste gas management and for the reduction of emissions by technical and management measures.

Environmental performance and operational data

No information provided.

Cross-media effect

None.

Technical considerations related to applicability

The level of detail of the inventory will generally be related to the nature, scale and complexity of the installation, and the range of environmental impacts it may have.

Economics

No information provided.

Driving force for implementation

Inventories/registers may be used to assess the implementation of BAT and may constitute basic information for authorities for setting emission limit values.

Example plants

The use of a stream inventory is applied in a number of installations throughout the EU.

Reference literature

[\[167, Pinasseau et al. 2018 \]](#), [\[168, COM 2016 \]](#).

8.1.3 Chemicals management system (CMS)

Description

The chemicals management system is part of the EMS (see Section 8.1.1) and is a set of technical and organisational measures to limit the impact of the use of process chemicals on the environment.

Technical description

The chemicals management system (CMS) contains the following components:

- I. A policy to reduce the consumption and risks of process chemicals, including a procurement policy to select less harmful process chemicals and their suppliers with the aim of minimising the use and risks of hazardous substances and avoiding the procurement of an excess amount of process chemicals. The selection of process chemicals may consider:
 - a) their eliminability, their eco-toxicity and their potential to be released into the environment in order to reduce emissions to the environment;

- b) the characterisation of the risks associated with the process chemicals, based on the chemicals' hazards statement, pathways through the plant, potential release and level of exposure;
- c) the regular (e.g. annual) analysis of the potential for substitution, to identify potentially new available and safer alternatives to the use of hazardous substances (e.g. use of other process chemicals with no or lower environmental impacts, see Section 8.4.1);
- d) the anticipatory monitoring of regulatory changes related to hazardous chemicals and safeguarding compliance with applicable legal requirements.

The inventory of process chemicals (see Section 8.1.2) may be used to support the selection of process chemicals.

- II. Goals and action plans to avoid or reduce the use and risks of hazardous substances.
- III. Development and implementation of procedures for the procurement, handling, storage, and use of process chemicals to prevent or reduce emissions to the environment (e.g. see Section 8.3).

Achieved environmental benefits

- Reduction of the use of hazardous chemicals.
- Reduction of emissions of hazardous chemicals to the environment.
- Reduction of the amount of hazardous chemicals in waste.

Environmental performance and operational data

The need to implement a chemicals management system in relevant IED installations depending on the amounts and diversity of chemicals used is described in more details in the conclusions of the HAZBREF project (Work package 3 / Activity 3.2). [[169, HAZBREF 2021](#)]

Cross-media effect

None.

Technical considerations related to applicability

The level of detail of the CMS will generally be related to the nature, scale and complexity of the plant.

Economics

No information provided.

Driving force for implementation

The driving forces for the implementation of a CMS include:

- improved environmental performance;
- compliance with regulations;
- optimised consumption of hazardous chemicals.

Example plants

No information provided.

Reference literature

[[169, HAZBREF 2021](#)]

8.2 Monitoring

8.2.1 Overview

Real data are required on the precise effects of the activities of the industrial site on the environment. It is thus necessary to conduct a planned, regular sampling and monitoring programme. The parameters monitored include:

- point sources channelled, diffuse and fugitive emissions to the atmosphere, water or sewer;
- wastes, particularly hazardous wastes;
- contamination of land, water and air;
- use of water, fuels, energy, oxygen, nitrogen and other gases (e.g. argon);
- discharge of thermal energy, noise, odour and dust;
- effects on specific parts of the environment and ecosystems;
- on-site accidents and near misses;
- staff injuries;
- transport accidents;
- complaints from community residents.

Monitoring, however, is not restricted to analytical measuring. It also includes regular maintenance, and visual and safety checks. Preferably, the monitoring records for emissions to air and water shall be made available in an electronic format.

In parallel to this document, a Reference Report on Monitoring of Emissions to Air and Water from IED installations exists in which the reader is referred for further information. [[170, Brinkmann et al. 2018](#)]

8.2.2 Monitoring of emissions to water

Description

Regular monitoring of emissions to water.

Technical description

Monitoring of the relevant parameters can be accomplished by online measurements (that facilitate rapid intervention and control of the waste water treatment plant - WWTP) or analytical results derived from waste water samples. Parameters to be monitored and the frequency of monitoring depend on the activities which are connected to the WWTP and to the destination of the treated effluent (direct discharge or indirect discharge after further treatment in another industrial WWTP or a municipal WWTP). Discharges may come from a WWTP that treats streams originating from one sector only (e.g. hot rolling) or from a common WWTP that treats streams originating from several FMP sectors and may also include streams from non-FMP activities.

The monitoring of emissions is carried out in accordance with EN standards or, if EN standards are not available, in accordance with ISO, national or other international standards which ensure the provision of data of an equivalent scientific quality.

Achieved environmental benefits

Monitoring the waste water of a FMP plant helps to maintain the proper operation of the facility and to detect accidental releases and thus helps to prevent any possible adverse environmental effects upon discharge of waste waters.

Environmental performance and operational data

Common parameters monitored are found in the common section on emissions to water (Section 7.2.1) and include: TOC, COD, HOI, TSS, B, Cd, Cr total, Cr(VI), Fe, Ni, Pb, Sn, Zn, Hg, total P and F.

Cross-media effects

Some equipment, ancillary materials and energy are required for carrying out monitoring. The COD measurement relies on the use of very toxic compounds (i.e. mercury and chromate).

Technical considerations relevant to applicability

Generally applicable to all waste water treatment plant where there are emissions to water.

Economics

The costs associated with monitoring the effluent waste water of a waste water treatment plant relate to personnel and equipment used for sampling and measurement.

Driving force for implementation

Environmental legislation.

Example plants

See Section 7.2.1.

Reference literature

[\[170, Brinkmann et al. 2018 \]](#)

8.2.3 Monitoring of channelled emissions to air

Description

Regular monitoring of emissions to air.

Technical description

Monitoring of the relevant parameters can be accomplished by online measurements (which facilitate rapid intervention and control) or analytical results derived from air samples. Parameters to be monitored and the frequency of monitoring depend inter alia on the activities responsible for generating the emissions to air.

The monitoring of emissions is carried out in accordance with EN standards or, if EN standards are not available, ISO, national or other international standards which ensure the provision of data of an equivalent scientific quality.

Achieved environmental benefits

Monitoring the waste gas of a FMP plant helps to maintain the proper operation of the plant and to detect accidental releases and thus helps to prevent any possible adverse environmental effects when the waste gas is emitted.

Environmental performance and operational data

Data for the common parameters monitored in FMP plants may be found in the sector specific sections on hot rolling (Section 2.3.5), cold rolling (Section 3.3.5), wire drawing (Section 4.3.5), hot dip coating (Section 5.3.5) and batch galvanising (Section 6.3.5). Some of the key parameters to be monitored are: dust, NO_x, HCl, HF, SO₂, CO, Ni and Pb.

Cross-media effects

Some equipment, ancillary materials and energy are required for carrying out monitoring.

Technical considerations relevant to applicability

Generally applicable to all FMP plants where there are channelled emissions to air.

Economics

The costs associated with monitoring the waste gas of a FMP plant relate to personnel and equipment used for sampling and measurement.

Driving force for implementation

Environmental legislation.

Example plants

See the relevant sector specific sections indicated above.

Reference literature

[170, [Brinkmann et al. 2018](#)]

8.3 General environmental performance

This section covers the areas, processes and activities of the FMP installation that are not covered elsewhere, as they refer to issues that are common for most of the FMP sectors. In particular, it covers the prevention of emissions to soil, groundwater and surface water, although the techniques are also relevant to the prevention of fugitive emissions to air resulting from the delivery/receipt of raw materials and other chemicals to/at the FMP plant up to their final preparation step prior to application. However, when considering the integrated operation and the complexity of an IED installation, overlaps and repetition with other sections are inevitable: these have been cross-referenced where found.

The design, construction and operation, also referred to 'good housekeeping' or 'good practice' plays an important role in the reduction of fugitive emissions and in occupational health. For many companies, simple, affordable good housekeeping measures are being effectively applied to minimise oil or acid consumption, improve efficiency, achieve a cleaner workplace and reduce costs.

Measures to prevent spillages and leakages are described extensively elsewhere, such as in the EFS BREF. The following sections are therefore a brief summary of key issues for this sector, together with more specific information relevant to the scale and type of operation.

8.3.1 Set-up and implementation of a plan for the prevention and control of leaks and spillages

Description

Preparation and implementation of a plan for the prevention and control of potential leaks and spillage incidents/accidents.

Technical description

A plan for the prevention and control of leaks and spillages is part of the EMS (see Section 8.1.1) and includes, but is not limited to:

- site incident plans for small and large spillages;
- identification of the roles and responsibilities of persons involved;
- ensuring staff are environmentally aware and trained to prevent and deal with spillages incidents;
- identification of areas at risk of spillage and/or leaks of hazardous materials and ranking them according to the risk;
- identification of suitable spillage containment and clean-up equipment and regularly ensuring it is available, in good working order and close to points where these incidents may occur;
- waste management guidelines for dealing with waste arising from spillage control;
- regular (at least on an annual basis) inspections of storage and handling areas, testing and calibration of leak detection equipment and prompt repair of leaks from valves, glands, flanges, etc.

Achieved environmental benefits

Prevents or minimises the contamination of surface waters, groundwaters and soils, and assists in site decontamination on cessation of activities. Also reduces fugitive emissions from solvent spillages.

Environmental performance and operational data

Small spills are likely to happen more often and the sum effect of these if not detected and dealt with is significant increases of fugitive emissions to air, soil and groundwater.

Cross-media effects

None.

Technical considerations relevant to applicability

The level of detail of the plan will generally be related to the nature, scale and complexity of the plant, as well as to the type and quantity of liquids used.

Economics

The following costs need to be considered:

- Staff time for training and updating plans.
- Materials for spillage and clean-up.

Driving force for implementation

- Reduced risks of liability from contamination.
- Reduced risks of associated accidents, e.g. preventing slippery floors, risk of fire.

Example plants

Widely used in all FMP sectors.

Reference literature

No information provided.

8.3.2 Use of oil-tight trays or cellars

Description

Hydraulic stations and oil- or grease-lubricated equipment are situated in oil-tight trays or cellars.

Technical description

Hydraulic stations and oil- or grease-lubricated equipment are situated in oil-tight trays or cellars to avoid penetration of oil into the ground in the event of leakage. Accidental releases are prevented by periodic checks and preventive maintenance of seals, gaskets, pumps and piping. In the event of spillage, oils are drained to pump sumps where they are discharged by a third party or used as fuel in iron and steel production (e.g. blast furnaces or coke ovens). [[127, Continuous Coating Shadow Group 1999](#)].

Achieved environmental benefits

Prevention of oil (hydrocarbon) contamination of water.

Environmental performance and operational data

No information provided.

Cross-media effects

None.

Technical considerations relevant to applicability

Generally, there are no technical restrictions to the applicability of this technique.

Economics

Installation costs and operating costs are both low. [[127, Continuous Coating Shadow Group 1999](#)]

Driving force for implementation

- Reduced risks of liability from contamination.
- Workplace health and safety objectives including reduced risks of associated accidents, e.g. preventing slippery floors, reducing risk of fire.

Example plants

Widely used.

Reference literature

[[127, Continuous Coating Shadow Group 1999](#)].

8.3.3 Prevention and handling of acid spillages and leaks

Description

Storage tanks for both fresh and spent acid are equipped with sealed secondary containment protected with an acid-resistant coating which is regularly inspected for potential damage and cracks. Loading and unloading areas for the acids are designed in such a way that any potential spillages and leaks are contained and sent to on-site treatment or off-site treatment.

Technical description

All storage tanks for both fresh and spent acid are equipped with efficient and sealed secondary containment and, if required, also with protective shields. This secondary containment is completely protected with an acid-resistant coating which is regularly controlled for potential damage and cracks. Furthermore, the loading and unloading area for the acids is designed in such a way that any potential leak is directly discharged to the waste water treatment plant or can be collected separately for on-site treatment or off-site treatment.

Achieved environmental benefits

Prevention of acid contamination of water.

Environmental performance and operational data

No information provided.

Cross-media effects

None.

Technical considerations relevant to applicability

Generally, there are no technical restrictions to the applicability of this technique.

Economics

No information provided.

Driving force for implementation

- Reduced risks of liability from contamination.
- Workplace health and safety objectives including reduced risks of accidents from workers' exposure to highly corrosive acids.

Example plants

Widely used.

Reference literature

No reference literature provided.

8.3.4 Techniques for storage and handling of coils

Description

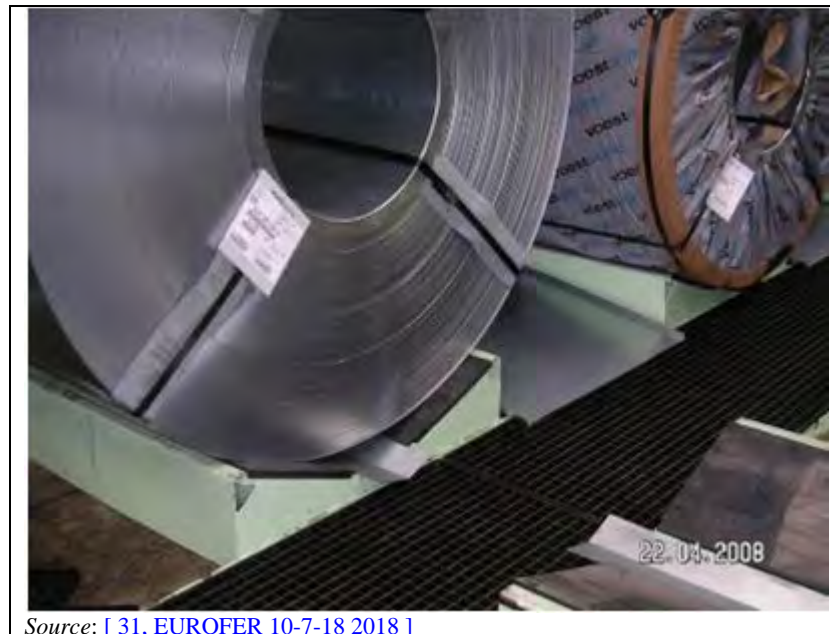
Process-integrated techniques for preventing soil contamination with oil during storage and handling of coils as intermediate or finished products, for avoiding coil damages, reworking (post-processing) and subsequent increase of the waste generated.

Technical descriptionStorage conditions for coils

As a matter of principle, the following is to be observed when storing steel coils:

- Avoid impairment or damage to material;
- Avoid confusion of materials/ensure retrieval of stored coils
- Ensure occupational health and safety/prevent accidents
- Prevent environmental impact resulting from leaking of anti-corrosion oil.

In the warehouse, coils are deposited in areas equipped with suitable coil supports allowing the coils to be deposited without being damaged. The coil supports are made of plastic, steel or wood. Steel scrims are lined with rubber or plastic. The design of the coil support corresponds to the coil geometry so as to avoid deformation and damage (See Figure 8.2). Drip trays can be used for the storage of oiled coils (See Figure 8.3).



Source: [31, EUROFER 10-7-18 2018]

Figure 8.2: Coil support lined with rubber corresponding to the coil geometry



Source: [31, EUROFER 10-7-18 2018]

Figure 8.3: Coil support with oil drip trays

Coil handling

Permissible hoisting gear for handling coils are cranes with coil tongs (See Figure 8.4), C-hooks magnets (See Figure 8.5), or pilers with mandrels (See Figure 8.6). Load-handling attachments are adjusted to the inner diameter of the coil. Chains, ropes and belts are not used as slings. The condition of the load-handling attachments is periodically checked, and wear parts are replaced depending upon their condition. The coils are checked at the exit section of the plant and protected from damage. Coils intended for ‘outdoor storage area’ are strapped with two steel straps.



Figure 8.4: Coil tong with protector



Figure 8.5: C-hook magnet for hoisting of coils



Source: [31, EUROFER 10-7-18 2018]

Figure 8.6: Piler with mandrels for coil manipulation and transport

Coil transfer (in-plant)

Coils are transferred with due care in order to avoid damage. In-plant transfer is performed using only permitted and designated means of transportation. This can be done using the following:

- Forklift trucks: Mandrel pilers may be used for transferring coils to an outdoor storage area. If transportation trailers are loaded and unloaded using mandrel pilers, special care is taken not to damage the inner and outer wraps of the coils during depositing. Furthermore, adequate distance is kept between the coils.
- Transportation trailers or railway cars: The coil supports are made of plastic, steel or wood. Steel scrims are lined with rubber or plastic. The design of the coil supports corresponds to the coil geometry. In order to ensure loading and unloading without damage, adequate distance is kept between the individual coils allowing the crane grab tongs to reach between the coils or the mandrel piler to load a coil onto or unload a coil from a trailer without coming into contact with the other coils. Transportation trailers and railway cars have appropriate coverings in order to protect them from rain and snow.

Achieved environmental benefits

- Prevention of soil contamination with oil.
- Energy savings through avoidance of further product treatment, finishing or reworking (post-processing).

Environmental performance and operational data

Approximately 10 % productivity loss can be expected via an increase in the scrap production if no appropriate measures are taken with respect to the storage and handling of intermediate and finished products. [31, EUROFER 10-7-18 2018]

Cross-media effects

None.

Technical considerations relevant to applicability

Generally, there are no technical restrictions to the applicability of this technique.

Economics

An exact cost calculation through the implementation of these measures is not possible. The estimated costs saved by optimising the storage and handling system correspond to approximately 10 % of the production value.

Driving force for implementation

- Material savings through less damage to intermediate products.
- Product saving through less damage to coils.
- Increased productivity.
- Reduction of scratched products.
- Preservation of product quality.

Example plants

Widely used.

Reference literature

[31, EUROFER 10-7-18 2018].

8.3.5 Set-up and implementation of an OTNOC management plan to reduce emissions during OTNOC

Description

A risk-based OTNOC management plan includes all of the following elements:

- identification of potential OTNOC (e.g. failure of equipment critical to the protection of the environment ('critical equipment')), of their root causes and of their potential consequences, and regular review and update of the list of identified OTNOC following the periodic assessment below;
- appropriate design of critical equipment (e.g. compartmentalisation of fabric filters);
- set-up and implementation of an inspection and preventive maintenance plan for critical equipment;
- monitoring (i.e. estimating or, where possible, measuring) and recording of emissions during OTNOC and of associated circumstances;
- periodic assessment of the emissions occurring during OTNOC (e.g. frequency of events, duration, amount of pollutants emitted) and implementation of corrective actions if necessary.

Technical description

When applying the processes described above in Chapters 2 to 6 and Chapter 8, the FMP plant may experience other than normal operating conditions (OTNOC). These OTNOC are very diverse and may cover conditions such as:

- start-up;
- shutdown;
- momentary stoppages;
- holding mode in heating furnaces;
- leaks (oils or acids);
- malfunction or breakdown of the abatement equipment or part of the equipment (e.g. fabric filters or ESPs);
- malfunction of instruments related to the process control or used for emission monitoring (such as instrumentation drift);
- testing of new apparatus;
- calibration of the monitoring system.

In order to reduce the frequency of the occurrence of OTNOC and to reduce emissions during OTNOC, a risk-based OTNOC management plan as part of the environmental management system (see Section 8.1.1) is put into place and may include the elements described in the description section above.

Achieved environmental benefits

Emissions associated with shutdown and start-up operations are in part avoided. Planning for and achieving a reduced number of shutdowns is likely to reduce the annual mass emission levels of any plant.

Environmental performance and operational data

Malfunctions in a waste gas treatment plant can result in a significant increase in emissions (e.g. dust). To prevent this, the following measures are put into place:

Preventive maintenance

Preventive maintenance is used to:

- ensure that maintenance requiring switching off emissions control equipment/systems (e.g. containment, extraction systems, off-gas treatment) is planned to take place when there are no emissions (e.g. shutdown times) or when emission levels are low;
- replace parts that require replacement on a regular basis is planned to take place before breakdowns are likely;
- ensure that parts that are essential to the normal running of emission control equipment are kept in stock, can be replaced or repaired rapidly with minimum call-off times;
- carry out routine and non-routine maintenance including maintenance of covers and pipe joints for oil/acid storage and delivery systems.

Regular maintenance checks

A maintenance schedule and record of all inspections and maintenance activities is kept and includes the following:

- visually check for leaking seals, flanges, valves, welds, tanks and vats;
- inspections by external experts where necessary;
- monitoring key equipment for problems such as vibration, emission leaks and planning repairs (as above);
- test programmes, e.g. pressure-test pipelines and tanks, calibration of metering and monitoring equipment;
- check the tightness of nuts and bolts;
- check for wear and tear on machinery, valves and bunds, over-heating bearings, etc.;
- recalibrate metering systems;
- ensure that extraction and abatement equipment is fully serviceable.

Unplanned maintenance

Process operators and maintenance staff identify and report leaks, broken equipment, fractured pipes, etc. to focus unscheduled maintenance.

Cross-media effects

None.

Technical considerations relevant to applicability

Generally, there are no technical restrictions to the applicability of this technique.

Economics

Avoiding plant shutdowns can reduce costs at FMP installations by:

- allowing continuous throughput and hence greater installation utilisation;
- decreasing furnace maintenance due to lower thermal stress on the process.

Driving force for implementation

- Reduces downtime.
- Maintains product quality and throughput.

Example plants

Widely used.

Reference literature

No reference literature provided.

8.4 Hazardous substances

8.4.1 Avoiding the use of hexavalent chromium compounds in passivation

See Sections 5.4.1.5.6 and 5.4.1.5.7.

8.5 Energy efficiency

8.5.1 Energy efficiency plan and energy audits

Description

An energy efficiency plan is part of the EMS (see Section 8.1.1) and entails defining and calculating the specific energy consumption of the activity, setting key performance indicators on an annual basis (e.g. MWh/tonne of product) and planning the periodic improvement targets and related actions. Energy audits are carried out at least once a year to ensure that the objectives of the energy management plan are met. The energy efficiency plan and the energy audits may be integrated in the overall energy efficiency plan of a larger installation (e.g. for iron and steel production).

Technical description

Extensive information about energy efficiency can be found in the Energy Efficiency BREF. [[171, COM 2009](#)] Some techniques applicable to increase the energy efficiency of FMP plants are as follows:

- a. Appraising the costs and benefits of different energy options.
- b. Monitoring energy flows (consumption and generation by source) and the targeting of areas for reductions.
- c. Defining and calculating the specific energy consumption of the activity (or activities), and setting key performance indicators on an annual basis (e.g. MWh/tonne of product).
- d. Carrying out an energy survey to identify the opportunities for further energy savings.
- e. Using heat recovery techniques from flue-gases.
- f. Applying operating, maintenance and housekeeping measures to the most relevant energy consumption plants, such as:
 - air conditioning, process refrigeration and cooling systems (leaks, seals, temperature control, evaporator/condenser maintenance);
 - operation of motors and drives (e.g. high-efficiency motors);
 - compressed gas systems (leaks, procedures for use);
 - steam distribution systems (leaks, traps, insulation);
 - room heating and hot water systems;
 - lubrication to avoid high friction losses (e.g. mist lubrication);
 - boiler maintenance, e.g. optimising excess air;
 - other maintenance relevant to the activities within the plant;
 - reviewing equipment requirements on a regular basis.
- g. Using techniques that reduce energy consumption and thereby reduce both direct (heat and emissions from on-site generation) and indirect (emissions from a remote power station) emissions. For example:
 - building insulation;
 - use of energy-efficient site lighting;
 - vehicle maintenance;
 - efficient plant layout to reduce pumping distances;
 - phase optimisation of electronic motors;
 - heat recovery;
 - ensuring equipment is switched off, if safe to do so, when not in use;
 - ensuring on-site vehicle movements are minimised and engines are switched off when not in use.
- h. Applying basic, low-cost, physical techniques to avoid gross inefficiencies; including insulation, containment methods (for example seals and self-closing doors) and avoiding unnecessary discharges of heated water or air (for example by fitting simple control systems).
- i. Applying energy efficiency techniques to building services.
- j. Using landfill gas to produce electricity and heat.
- k. Using heat from the furnaces and engines for vaporisation, drying and for preheating activities.

When a FMP plant is embedded in the energy network of a larger installation, the energy efficiency plan of the FMP plant may be integrated in the overall energy efficiency plan of the larger installation (e.g. for iron and steel production).

Energy audits are carried out at least once a year to ensure that the objectives of the energy management plan are met. Audits may be carried out using international standards which have been developed to support the implementation of energy audits under the Energy Efficiency Directive (e.g. EN 16247-1:2012 and ISO 50002:2014).

Achieved environmental benefits

Reduction of energy consumption and emissions relevant for that energy use.

Environmental performance and operational data

No information provided.

Cross-media effects

None.

Technical considerations relevant to applicability

The level of detail of the energy efficiency plan and of the energy audits will generally be related to the nature, scale and complexity of the plant and the types of energy sources.

Economics

No information provided.

Driving force for implementation

Energy savings.

Example plants

Widely used.

Reference literature

[\[171, COM 2009 \]](#), [\[172, EN standard 16247-1 2012 \]](#), [\[173, ISO standard 50002 2014 \]](#).

8.5.2 Energy balance record

Description

An annual energy balance record is carried out, providing a breakdown of the energy consumption and generation (including energy export) by the type of energy source (e.g. electricity, natural gas, iron and steel process gases, renewable energy, imported heat and/or cooling).

Technical description

The technique involves the drawing up on an annual basis of an energy balance record which provides a breakdown of the energy consumption and generation (including energy export) by the type of source (e.g. electricity, natural gas, iron and steel process gases, renewable energy, imported heat and/or cooling). This includes:

- (i) defining the energy boundary of the processes;
- (ii) information on energy consumption in terms of delivered energy;
- (iii) information on energy exported from the plant;
- (iv) energy flow information (e.g. Sankey diagrams or energy balances) showing how the energy is used throughout the processes.

Achieved environmental benefits

Reduction of energy consumption.

Environmental performance and operational data

The reduction of emissions from the energy system can only be evaluated with a proper calculation of the actual emissions generated. The breakdown between generation and consumption can help to optimise the balance between them and hence to optimise the use of energy resources.

Cross-media effects

None.

Technical considerations relevant to applicability

The level of detail of the energy balance record will generally be related to the nature, scale and complexity of the plant and the types of energy sources.

Economics

The requirements are basic and cost little.

Driving force for implementation

Reduction of energy costs.

Example plants

Widely used.

Reference literature

[\[171, COM 2009 \]](#).

8.5.3 General techniques to increase the energy efficiency of heating

8.5.3.1 Optimum furnace design for feedstock heating

Description

This includes techniques such as the following:

- Optimisation of key furnace characteristics (e.g. number and type of burners, air tightness and furnace insulation using suitable refractory materials).
- Minimisation of heat losses from furnace door openings, e.g. by using several liftable segments instead of one in continuous reheating furnaces.
- Minimisation of the number of feedstock supporting structures inside the furnace (e.g. beams, skids) and use of suitable insulation to reduce the heat losses from water cooling of the supporting structures in continuous reheating furnaces.

Technical description

Furnace design

The design of the furnace and the degree of insulation have a significant effect on thermal efficiency. The furnace together with the number and the capacity of the burners are carefully calculated starting from several realistic production scenarios. Different heating temperatures of the stock, differences in production rhythm caused by changes in the dimensions of the stock or as a result of changes in the production rhythm of the hot mill, as well as periods where hot or direct charging is applied are taken into account. [\[4, EUROFER 1998 \]](#)

The appropriate equipment is available to limit the emissions and the energy consumption in case of a sudden line stop. This means that the temperature can easily be turned down or burners switched off in certain furnace sections. In the latter case, a N₂ purge might be necessary for safety reasons. [\[4, EUROFER 1998 \]](#), [\[26, Hot Rolling Shadow Group 1999 \]](#)

Generally, the following recommendations are considered, preferably in the design process:

- Radiant burners in the roof of the furnace, due to quick dissipation of energy, produce lower NO_x levels.
- The insulation properties of the refractory material are important; therefore constructional measures should be taken to increase the lifetime of the refractory material, as damage in the refractory material cannot be repaired immediately.
- Use of low-thermal-mass refractory material can reduce stored energy losses and reduce light-up energy and time. [37, ETSU 1993]
- Improved airtightness of furnaces and installation of specially designed doors, to reduce tramp air. [37, ETSU 1993]
- Door areas and/or charge and discharge door gaps are minimised, and insulating refractory curtains used for times when doors are necessarily open (provided that excessive mechanical damage to stock can be avoided). [37, ETSU 1993]

More information on the minimisation of heat losses from door openings and on the minimisation of the number of feedstock supporting structures to reduce heat losses can be found in the specific sections 2.4.2.2 and 2.4.2.13, respectively.

Achieved environmental benefits

- Reduced energy consumption.
- Reduction of NO_x and CO emissions.

Environmental performance and operational data

The furnace is run with 'good craftsmanship'. Even sophisticated installations can give poor results in emission and thermal efficiency if the process is not properly operated and if the installations are not maintained on a regular basis. Experience has shown that good housekeeping can lead to fuel savings of up to 10 %. [37, ETSU 1993]

Furnace control is very important for efficient operation and different techniques such as pulse firing can increase the efficiency of fuel use and good temperature control. [31, EUROFER 10-7-18 2018]

Turbulence in the flame of the burners is avoided. Investigations showed indeed a marked increase in the NO_x produced by temperature fluctuations compared to the NO_x values produced by a steady flame operating at the same mean temperature-

Air excess is also an important factor for the control of the NO_x emission level, the energy consumption and the formation of scale. The air excess should be minimised without excessive CO emission and without compromising the effective operation of the furnace. Special care should be taken to avoid the presence of tramp air, which increases the energy consumption as well as the NO_x emission. A mass spectrometer is useful in keeping the air/gas ratio at an optimal level for fuels with a variable or unknown composition. [4, EUROFER 1998]

Heat stored in the refractories is supplied during the start-up period and the first production shift. During continuous operation this stored heat is usually regarded as negligible. When down-shift practices are employed (e.g. at weekends) or when furnaces are deliberately cooled for maintenance reasons, these energy losses can become an important factor as this energy has to be put in during furnace heat-up for the next production period. For two cases, the stored energy losses during weekend plant shutdown were reported: 0.409 GJ/m² and 0.243 GJ/m². During production stoppages and weekends, doors should be closed and sealed to retain the heat. The use of low-thermal-mass refractories can reduce light-up time, energy consumption and operating costs. [37, ETSU 1993]

Maintenance of control systems and burners is very important. Control valves, linkages, burner internal components and cooling systems are maintained using good planned maintenance

standards to ensure reliable and efficient operation. Damaged burners and control valves can result in elevated emissions from the furnace and inefficient use of fuel.

[31, EUROFER 10-7-18 2018]

Cross-media effects

None.

Technical considerations relevant to applicability

Only applicable to new plants and major plant upgrades.

Economics

No information provided.

Driving force for implementation

- Reduced energy consumption.
- Reduction of NO_x and CO emissions.

Example plants

Widely used.

Reference literature

[4, EUROFER 1998], [26, Hot Rolling Shadow Group 1999], [31, EUROFER 10-7-18 2018], [37, ETSU 1993].

8.5.3.2 Combustion optimisation

Description

Measures taken to maximise the efficiency of energy conversion in the furnace while minimising emissions (in particular of CO). This is achieved by a combination of techniques including good design of the furnace, optimisation of the temperature (e.g. efficient mixing of the fuel and combustion air) and residence time in the combustion zone, and the use of furnace automation and control.

See the LCP BREF for more information [23, Lecomte et al. 2017].

Reference literature

[23, Lecomte et al. 2017].

8.5.3.3 Furnace automation and control

Description

The heating process is optimised by using a computer system controlling in real time key parameters such as furnace and feedstock temperature, the air to fuel ratio and the furnace pressure.

Technical description

Furnace automation takes care of the combustion, the energy consumption, material handling, temperature control of the feedstock and process safety continuously. In addition, it enables adjustment of the air to fuel ratio for optimum combustion which in turn minimises NO_x emissions. [25, EUROFER 2018]

With the help of a process computer, the heating process can be optimised (e.g. no unnecessary overheating of feedstock during interruptions, more accurate temperature control) in accordance with the material quality and dimensions. [4, EUROFER 1998]

Furnace pressure control: If the furnace pressure is below atmospheric pressure, cold air will be drawn into the chamber through doors and openings. Conversely, if it is above atmospheric pressure, hot gases will be forced out through the same openings. For reasons of energy efficiency, consistency of operation and product quality, furnaces are usually operated at a slight positive pressure compared with the outside air. [37, ETSU 1993]

Another reason to maintain a slightly positive furnace pressure is for safety, to prevent air ingress which might provide an explosive mixture if fuel/gas were ignited, especially on start-up. [26, Hot Rolling Shadow Group 1999]

Air to fuel ratio control: Control of the air to fuel ratio is necessary to regulate the quality of the combustion, as it ensures flame stability and complete combustion. Adjusting the air to fuel ratio as close as possible to stoichiometric conditions results in higher fuel efficiency and reduced exhaust gas energy losses. Measurements of the oxygen concentration in the combustion products in the furnace can be used to provide a signal to trim air to fuel ratio control systems (*Oxygen Trim Control*). [37, ETSU 1993]

Material temperature control: By using a supervisory computer system to calculate the temperature of the feedstock (slabs, blooms, billets, etc.), heating above the target temperature is prevented. The Furnace Optimisation Control System (FOCS) determines set points for temperature in various zones of the furnace and controls the furnace flow on the basis of the calculated workpiece temperatures and current production status in order to produce optimally heated materials. [25, EUROFER 2018]

Reheating time control: The reheating time in the furnace is a key parameter. It depends on the exit target temperature, the size and the steel grade of the product, the characteristics of the furnace, the targeted level of plant production and the bottleneck of the plant (either at the rolling mill level or at the furnace level). The computer system is able to predict the optimised reheating time. In case of problems at the rolling mill level, the computer system takes into account any change in terms of reheating time within each zone of the furnace. [3, EUROFER 2020]

Achieved environmental benefits

- Reduced energy consumption.
- NO_x reduction.

Environmental performance and operational data

Example: Oxygen Trim Control

A system using zirconia-based oxygen measuring cells has been installed at Rotherham Engineering Steels walking beam furnace which is used for reheating square billets from cold to 1 200 °C. The 110 t/h capacity furnace operates six independently controlled temperature zones. It is usually fired by natural gas or with heavy fuel as an alternative during interruptions in gas supply. The oxygen trim control resulted in a lower average oxygen concentration in the furnace than with conventional air to fuel ratio control. Energy savings of about 2 % were achieved: although the reduction in oxygen content suggests that savings of around 4.7 % could realistically be achieved, this potential has been reduced by an increase in temperature in the heating zones. Additional benefits included improved product quality and reduced maintenance costs. [11, ETSU - b 1993], [174, ETSU 1995]

Raahe Plate Mill uses continuous oxygen control in all bottom and top zones. The oxygen set point is low for the majority of slabs and a higher oxygen set point is used only for special slabs. [25, EUROFER 2018]

Example: Computer-controlled furnace management

Computer-controlled furnace management installed at two pusher-type furnaces used to reheat cold charged slabs at British Steel, Teeside, resulted in energy savings of 15 % for both furnaces. The formerly manually adjusted temperature zones switched to computer-controlled (using on-line mathematical models) to provide optimal heating profiles.

Implementation of computerised furnace control at a German pipe production site led to energy savings of 5 % and a reduction of scale generation during reheating of up to 30 %. [63, Grobe et al. 1996]

Example: Roller hearth furnaces

In roller hearth furnaces, selected furnace zones can be switched to standby mode when no slab is present inside the furnace by using computerised furnace control. Additionally, depending on the actual slab temperature, the temperature of the zones and the duration of slab heating are adjusted. [25, EUROFER 2018]

Table 8.1: Typically achievable reductions and cost data for furnace automation

Furnace automation ²	Reduction [%]	
	NO _x	Energy ¹
	10	10
Note: <i>Source:</i> [4, EUROFER, 2018]. Basis is a furnace with a yearly capacity of 1.5 Mt fired with natural gas with standard burners and without air preheat. Investment costs can be site specific (available room, layout of the existing furnace, number of side and bottom burners)		
¹ In percentage terms, the energy reduction is matched by the reduction in SO ₂ , CO and CO ₂ emissions		
² With furnace automation is meant all measures that allow a quick adaptation of the furnace parameters to changes in the production and a tight control of the air excess		

Cross-media effects

No negative effects on other media are known.

Technical considerations relevant to applicability

Generally, there are no technical restrictions to the applicability of this technique.

Economics

No information provided.

Driving force for implementation

- Reduced energy consumption – energy savings.
- Improved product quality and reduced maintenance costs.

Example plants

Widely used.

Reference literature

[4, EUROFER, 2018], [11, ETSU - b 1993], [25, EUROFER 2018], [37, ETSU 1993], [63, Grobe et al. 1996] [174, ETSU 1995].

8.5.3.4 Process gas management system

Description

A system that enables iron and steel process gases to be directed to the reheating and/or heat treatment furnaces, depending on their availability. The calorific value of iron and steel process gases and/or CO-rich gas from ferrochromium production is used.

See the LCP BREF for more information related to the relevant iron and steel process gases.

See the NFM BREF for more information related to CO-rich gas from ferrochromium production. [34, COM 2017]

Technical considerations relevant to applicability

Only applicable when iron and steel process gases and/or CO-rich gas from ferrochromium production are available.

Reference literature

[23, [Lecomte et al. 2017](#)], [34, [COM 2017](#)].

8.5.3.5 Batch annealing with 100 % hydrogen**Description**

Batch annealing is carried out in furnaces using 100 % hydrogen as a protective gas with increased thermal conductivity.

Technical description

Conventional batch annealing in annealing furnaces is carried out under a hydrogen/nitrogen atmosphere (e.g. HN) consisting of about 5 % H₂ and 95 % N₂. In some cases, up to 7 % H₂ may be used. High-Performance Hydrogen (e.g. HPH) annealing of steel coils consists of using 100 % hydrogen and results in better productivity, improved mechanical properties, surface and product quality. [31, [EUROFER 10-7-18 2018](#)]

The changeover to an atmosphere with 100 % H₂ has the following effects on the heating and cooling process:

- 1) The heat transfer by convection between the gas and the steel surface will increase owing to the relatively higher thermal conductivity of hydrogen gas. The effect is approximately a 60 % higher convective heat transfer rate.
- 2) The smaller size of H₂ molecules compared to N₂ enables easier penetration of the gas into the small gap between the layers of the coiled strip. Since H₂ also has a higher ability to absorb heat, it will increase the axial thermal conductivity in a coil, by approximately a factor of 7.
- 3) The lower specific weight of H₂ also allows a higher circulation of the gas for the heat transfer.

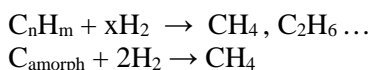
Pure hydrogen bell furnaces can be equipped with gaseous fuel burners, allowing the surplus/leftover of the reduction gases (mainly H₂, but also the residuals from oil, CH₄, C_nH_m, CO and H₂O) to be burned together with the main fuel in order to maximise the use of hydrogen. The method of using the off-gases in the burners for heating the process allows to treat and eliminate the oil and other organic materials from the product.

The benefits of higher heat transfer to and within the coil enables an increased production rate with a lower heating and cooling time as well as lower specific energy consumption. A faster heating rate means less specific consumption of gases and electrical energy.

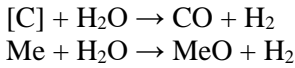
H₂ reacts very quickly and intensively with air. Using a 100 % hydrogen atmosphere, process safety actions are put in place to avoid reactions with air, including continuous supervision of the annealing process.

A higher amount of H₂ provides the possibility to penetrate better between the layers of a coil, facilitating decarburising reactions between hydrogen and oil contamination products on the coil. The decarburising power of pure hydrogen is significantly higher than that obtained in a protective atmosphere composed of nitrogen / 5 % hydrogen. [175, [Scheuermann et al. 1995](#)]

This results in a cleaning effect when the following reactions take place:



In addition, a higher H₂:H₂O ratio helps preserve the structure of the steel surface by preventing to a certain extent the following reactions from taking place:

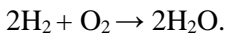


Where:

Me = any kind of metal;

MeO = any kind of metal oxide.

Figure 8.7 shows the chemical reactions taking place during the heating up of the charge in a 100 % hydrogen bell annealing furnace. Reaction A (blue line) is the reduction of any free oxygen:



From steps B to E, the consecutive chemical reactions taking place during the annealing process are detailed. Overall, a high concentration of H₂ helps the reduction of any oxides and the hydrogenation of heavy hydrocarbons; these reactions are only limited when using a conventional HN annealing furnace.

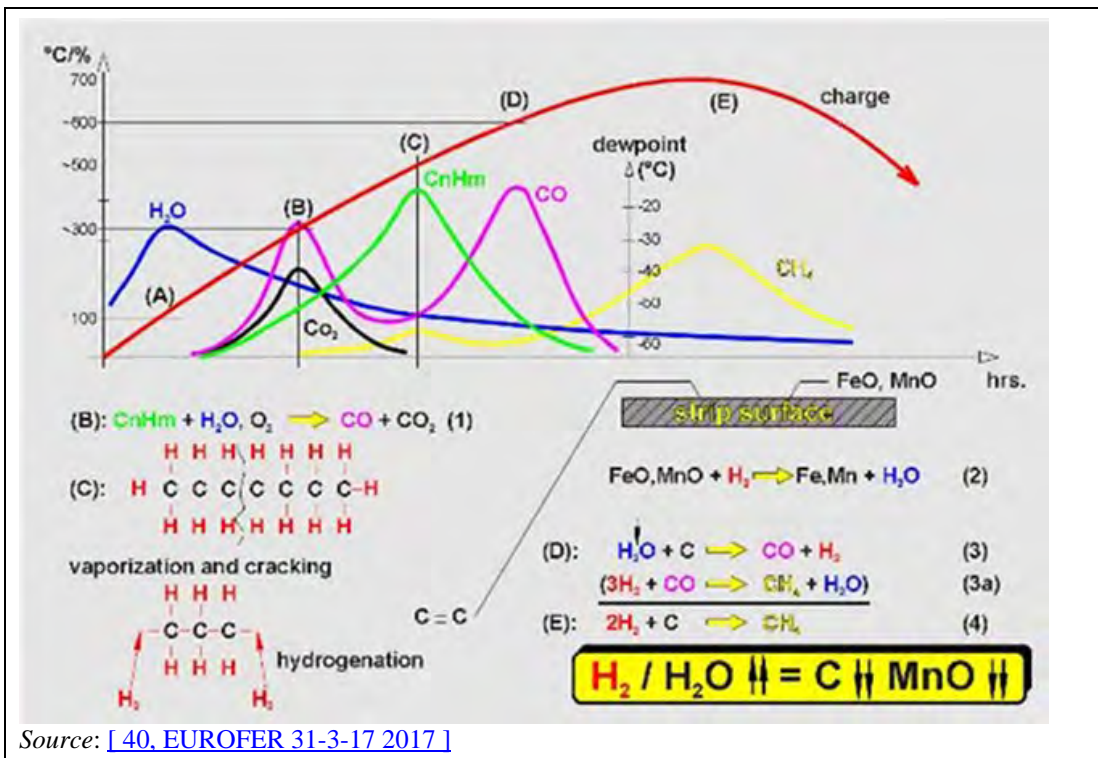


Figure 8.7: Chemical reactions within 100 % Hydrogen Bell Annealing

Achieved environmental benefits

Reduced energy consumption.

Environmental performance and operational data

At SSAB Borlänge site, there are five HPH bell furnaces operating with 100 % hydrogen and four electrically heated HN furnaces. For these furnaces, operational data are given in Table 8.2. These data are aggregated over a three-year period from the actual plant production. In this exercise, the fact that different annealing cycles could have been used in the different furnaces was not taken into consideration. [31, EUROFER 10-7-18 2018]

Regarding the data reported, it should be noted that the energy savings figures are related to the time of process. No data were available for the energy savings from the base fans and electrical heating component separately. Also, product grade (and hence annealing cycles) as well as loading (tonne/batch), strip thickness which can have an influence on data such as annealing time and energy efficiency (per tonne) were not considered. [31, EUROFER 10-7-18 2018]

Table 8.2: Productivity rate, energy and gas consumption and NO_x emissions data at SSAB Borlänge annealing furnaces (HN and HPH)

	Electrical HN furnace	HPH (100 % H ₂) furnace	Difference
Productivity (tonne/h)	0.5	2.0	200 %
Energy [kWh/tonne] (electricity and LPG)	427	253	-41 %
N ₂ gas [m ³ /tonne]	83	8.7	-90 %
H ₂ gas [m ³ /tonne]	2.9	6	107 %
NO _x [kg/tonne]	NI	0.21	NI
NB: NI = No information provided. Source: [31, EUROFER 10-7-18 2018]			

At SSAB, only the H₂ bell furnaces emit NO_x because the other HN furnaces are electrically heated.

In total, 10 plants from the data collection using this technique reported energy consumption values within the range 580 MJ/t to 800 MJ/t. [16, FMP TWG 2018]

Cross-media effects

Compared with electrically heated furnaces, the use of HPH furnaces may result in higher emissions to air. In order to fully utilise the H₂, efficiency increases can be achieved if using a combustion technology for heating the bell where the surplus of H₂ can be combusted together with natural gas or another fuel.

Technical considerations relevant to applicability

Only applicable to new plants and major plant upgrades.

Economics

No information provided.

Driving force for implementation

- Productivity, surface quality, cost savings depending on fuel prices.
- High product quality standards can bet met.

Example plants

Plants from the data collection: 08 CR, 37 CR, 45 CR, 110 CR1, 110 CR2, 112 CR, 115 CR, 116 CR, 128 CR, 144 CR, 193 CR, 194 CR.

Reference literature

[31, EUROFER 10-7-18 2018], [175, Scheuermann et al. 1995], [176, Wendt et al. 2015].

8.5.3.6 Optimum galvanising kettle design

Description

This includes techniques such as:

- uniform heating of the galvanising kettle walls (e.g. by using high-velocity burners or radiant design);
- minimisation of heat losses from the furnace using insulated outer/inner walls (e.g. ceramic lining).

Technical description

Furnace heating efficiency should be considered in two parts: firstly the efficiency with which heat is transferred from the prime heat source to the galvanising bath and, secondly, the efficiency with which the transferred heat is employed for maintaining the zinc temperature.

The efficiency of heat transfer to the kettle is governed by basic principles of heat transfer and combustion engineering. Combustion of gases and oils results in a flow of flue-gas products which carries away sensible and latent heat. This amounts typically to 45 – 55 % of the gross calorific input of the fuel at maximum input. A small amount of electrical energy is used to drive the combustion air fan, and the pump or compressor used in oil heating. Use of electricity for heating involves energy loss owing to reactance effects and often also to cooling of temperature-sensitive parts of the heating system. Losses may be around 15 % of the metered power. For all energy sources, there is additional heat loss from the furnace case, although for a well-insulated furnace this is small, typically 2 % of the energy input. All losses in this category increase as the heat input increases.

Losses from the system are also due to radiation and convection from the molten metal surface and from exposed parts of the top of the bath, such as the top flange on a steel kettle. The extent of these losses depends on the surface areas, conditions and temperatures, but is typically 15 to 25 % of the heat originally transferred to the bath.

Flue-gas heat losses may be reduced by optimising the combustion process, by optimising excess air for combustion and by reducing air ingress to the furnace casing. The low-temperature operation of the galvanising process implies that there are limited opportunities for energy saving by reduction of losses. The burner system must be capable of accommodating a turn down ratio of approximately 15:1.

In some cases, minimisation of heat losses from the furnace is achieved using insulated outer/inner walls (e.g. ceramic lining).

Furnace efficiency is also affected by the control system. Higher efficiencies are obtained with control systems which most closely match the heat input to the heat demand. Determination of heat input is based on the molten zinc temperature, measured by thermocouples either immersed in the zinc or – for steel kettles – possibly by contact with the external kettle wall. Depending on the flexibility of the heating system the controller often uses PID (Proportional, Integral, Derivative) or other control logic to keep the zinc temperature as constant as possible. In some cases, a two-zone temperature control can be installed where the heating system can be divided in two zones, the upper and the lower zone. This can also help to control and minimise the formation of top dross.

Combustion systems include High/Low (either maximum or minimum heat is delivered for a period), Modulating (the heat input varies constantly over a range between maximum and minimum), or Pulsing (a continual succession of maximum and minimum heat inputs is delivered equating to a net intermediate heat input).

In the case of gas-fired burners, high velocity burners are employed to ensure an optimal heat transfer towards the galvanising kettle. In the case of induction heating, heating panels with a radiant design are used for uniform heating of the kettle walls.

Achieved environmental benefits

Reduced energy consumption.

Environmental performance and operational data

Losses from the system are also due to radiation and convection from the molten metal surface and from exposed parts of the top of the bath, such as the top flange on a steel kettle. The extent of these losses depends on the surface areas, conditions and temperatures, but is typically 15 % to 25 % of the heat originally transferred to the bath.

Cross-media effects

None.

Technical considerations relevant to applicability

Only applicable to new plants and major plant upgrades.

Economics

No information provided.

Driving force for implementation

Reduced energy consumption – energy savings.

Example plants

Widely used.

Reference literature

No reference literature provided.

8.5.3.7 Optimum galvanising kettle operation

Description

This includes techniques such as minimisation of heat losses from the galvanising kettle in hot dip coating of wires or in batch galvanising, e.g. by using insulated covers during idle periods.

Technical description

In hot dip coating of wires or in batch galvanising, surface losses may be reduced during working (subject to adequate ventilation) by use of an enclosure over the bath, or limiting the open part of the surface to that required for the type of galvanising in progress. When the kettle is on hot standby (idle periods), reductions in heat loss can be obtained by the use of insulated covers which extend over the furnace top. Reducing the bath temperature during hot standby periods rarely saves significant amounts of energy and, with steel kettles, cycling of the bath temperature adversely affects the protective zinc-iron alloy, thus reducing the kettle's working life.

Achieved environmental benefits

Reduced energy consumption.

Environmental performance and operational data

No information provided.

Cross-media effects

None.

Technical considerations relevant to applicability

Generally, there are no technical restrictions to the applicability of this technique.

Economics

No information provided.

Driving force for implementation

Reduced energy consumption – energy savings.

Example plants

Widely used.

Reference literature

No reference literature provided.

8.5.4 General heat recovery techniques from flue-gases

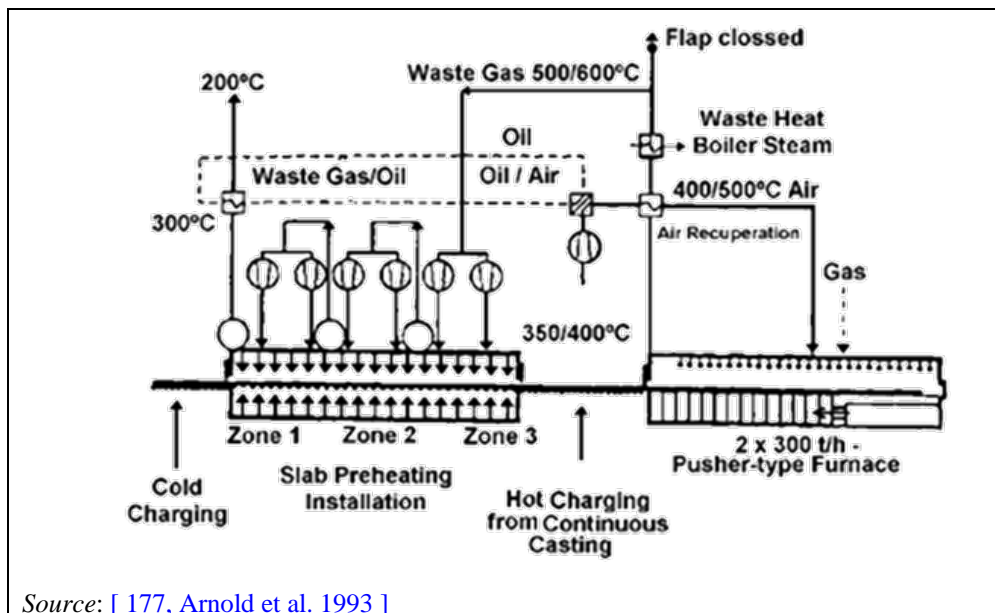
8.5.4.1 Feedstock preheating

Description

Feedstock is preheated by blowing hot flue-gases directly onto it.

Technical description

The heat in the waste gas of heating furnaces can be used to preheat the feedstock by blowing the hot waste gas from above and below onto the slab in hot rolling. Even after regenerative burners and a waste heat boiler, the waste gas can have enough energy to heat the slabs up to 400 °C. Figure 8.8 shows the example of a slab preheater installed upstream of a pusher-type heating furnace.



Source: [177, Arnold et al. 1993]

Figure 8.8: Principle of slab preheating using waste gas

As an alternative to preheaters, the heat of waste gas can be used also in very long walking beam furnaces in the unfired long preheating zone. [177, Arnold et al. 1993]

In cold rolling (e.g. continuous annealing), the feedstock is preheated either by a direct contact between the strip and the flue-gases or the heat can be transferred to the strip by the protective gas which is heated by the waste gas using heat exchangers. Direct contact is only possible in controlled circumstances (depending on the temperature of the gas and of the strip, the oxidation potential of the gas, the moisture, the contamination of the gas with particles). The result is a reduction of energy consumption.

Regenerative and recuperative burners are bigger than conventional burners. However, according to the data collection, a large number of plants have reported the use of air preheating using regenerative or recuperative burners. In the majority of cases, these burners were retrofitted to existing installations.

Even though new furnace models need to be put in place in order to regulate the furnace pressure when regenerative burners are employed, this is technically feasible.

Results from the data collection show that several plants equipped with regenerative burners are using process gases including COG (e.g. Plants 126 and 08-09-HR), in some cases up to 100% COG.

Compact regenerative burners are commercially available where heat recovery takes place in the burner itself, meaning that while air is preheated, the flue-gases are cooled directly inside the burner which can extract its own combustion products locally. When this type of regenerative burner is used, there is no longer any need for a centralised uptake system for hot flue-gases where energy is recovered using a central heat recuperator at the chimney.

Achieved environmental benefits

Reduced energy consumption in the heating furnace (20 %).

Environmental performance and operational data

Hot rolling:

The preheater shown in Figure 8.8 is installed upstream of two pusher-type furnaces. The furnaces have capacities of 300 t/h and are fired by regenerative burners. The heat from the waste gas of the furnace is first used for heat recovery in a waste heat boiler. After that, it still has a temperature of 500–600 °C and is further used in the preheater to heat the slabs at temperatures up to 400 °C. The waste gas leaving the preheater still has a temperature of 300 °C and is used to preheat the combustion air for the regenerative burners of the heating furnace to about 150 °C (by means of an oil heat exchanger). The waste gas is discharged at a temperature of 200 °C. [177, Arnold et al. 1993]

Continuous annealing

An energy consumption of 945 MJ/t is reported by one plant of the data collection using this technique.

Cross-media effects

No negative effects on other media are known.

Technical considerations relevant to applicability

- Only applicable to continuous reheating furnaces.
- Not applicable to furnaces equipped with radiant tube burners.

Economics

No information provided.

Driving force for implementation

Increased energy efficiency.

Example plants

Plants from the data collection:

Hot rolling: 94 HR1, 99 H1, 99 HR2, 101 HR, 147 HR, 208 HR, 222 HR, 288 HR.

Cold rolling: Only one continuous annealing plant in the data collection (CBI).

Reference literature

[16, FMP TWG 2018], [177, Arnold et al. 1993], [206, BE 2021].

8.5.4.2 Drying of workpieces

Description

In batch galvanising, the heat from flue-gases is used to dry the workpieces.

Technical description

Galvanising kettles may be fired either by gaseous or liquid fuels. The method most commonly used for heat recovery from combustion gas is transfer to air or water. Heat exchangers typically fabricated from banks of stainless steel tubes are used to recover heat from flue-gas to air. The flue products are normally on the tube side. Flue products may be introduced at 500–700 °C when the furnace is operating at full production rate. The heat exchanger may be placed directly in the furnace flue duct but, in the absence of forced extraction of flue-gases, only a small flue-gas pressure drop can be tolerated. This limits the rate of heat transfer.

Shell and tube heat exchangers can be used to transfer heat from flue products to water or steam, with flue-gas on the shell side. Another common type of exchanger is a bank of finned tubes placed in the flue duct. In this case, water is on the tube side.

Gases may be drawn through the heat exchanger using a fan downstream of the exchanger in order to increase the overall coefficient. This is a common arrangement for gas-to-water heat exchange. Both the heat exchanger and fan are located in a branch parallel to the main flue duct, thus avoiding any back-pressure effect on the furnace. The fan consumes a small amount of power.

In a few cases, flue-gases are in direct contact with the outer surface of a pretreatment tank, transferring heat by radiation and convection.

Heat exchangers for oil fuels and for surface-heated baths require special design due to the presence of SO₂ and ash in the flue-gases. [146, EGGA 2000]

Achieved environmental benefits

Reduced energy consumption.

Environmental performance and operational data

Energy reductions in the range of 15–45 kWh/t of steel.

Cross-media effects

None.

Technical considerations relevant to applicability

- Generally, there are no technical restrictions to the applicability of this technique.
- In principle, the technique can be applied to any installation subject to economic analysis, which depends on the fuel price, the thermal rating of the furnace and the demand for waste heat.
- It is not normally worthwhile in two-burner systems (small kettles) because there is not enough heat available to be useful. Heat recovery systems are very frequently installed on four- and six-burner systems.

Economics

No information provided.

Driving force for implementation

Fuel costs.

Example plants

Plants from the data collection: 71, 75, 186, 192.

Reference literature

[146, EGGA 2000]

8.5.4.3 Preheating of combustion air**Description**

Reuse of part of the heat recovered from the combustion flue-gas to preheat the air used in combustion. This may be achieved for example by using regenerative or recuperative burners. A balance has to be achieved between maximising heat recovery from the flue-gas and minimising NO_x emissions.

Technical description

To improve the thermal efficiency of furnaces, the exhaust gases from the furnace may be used to preheat the combustion air. Thermal efficiency increases with increasing preheated air temperature and decreasing waste gas temperature. The diagram in Figure 8.9 shows potential fuel savings achieved by preheating combustion air. Actual values might differ from these theoretical figures as they are subject to a number of other influences.

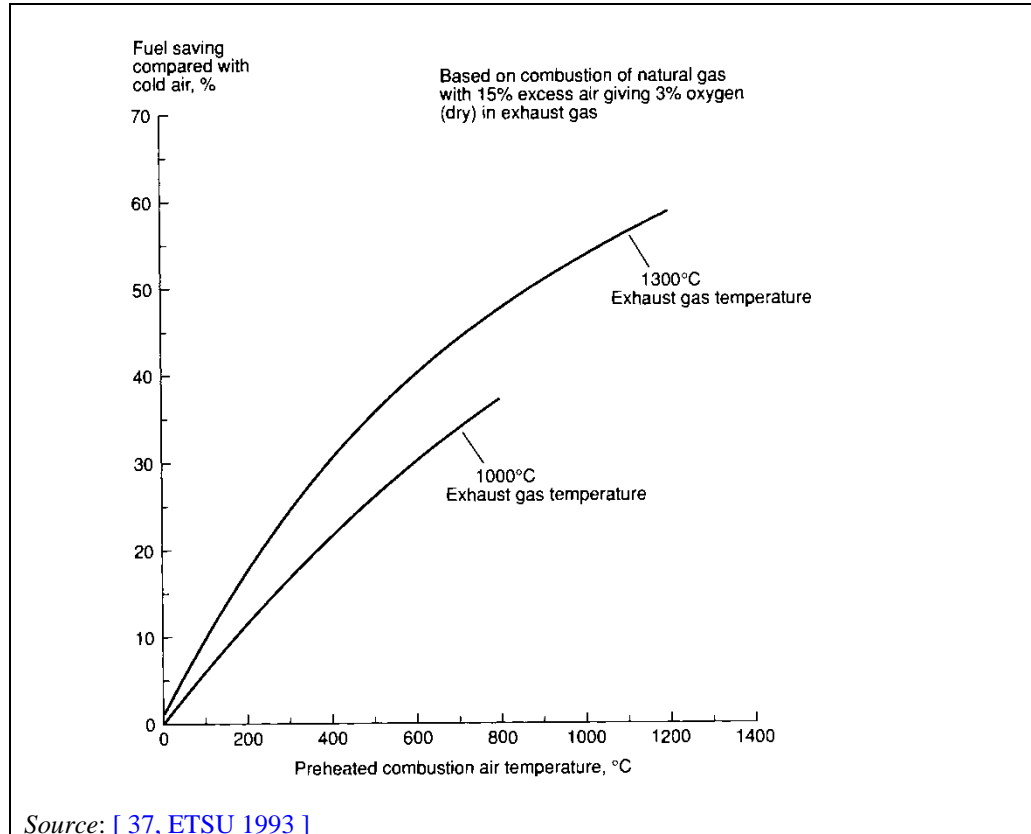


Figure 8.9: Potential fuel savings with preheating of combustion air

For preheating of combustion air, two systems exist: regenerative and recuperative burners.

Regenerative burners

Regenerative systems use two sets of heat exchangers, containing for example brick chequer material or ceramic balls. Figure 8.10 shows an example of such a regenerative burner system that can be found in continuous reheating furnaces or annealing furnaces. When one burner is fired, the furnace gases are channelled via the other burner. The exhaust gases pass through a regenerator which contains a bed of refractory or ceramic materials. The refractory materials are heated by the exhaust gases and store the energy, which is then used to preheat the combustion air. When the refractory materials are fully heated, the firing burner is turned off and the regenerated burner is put into operation. Typical reversal times are in the range of 20 s to 100 s.

New regenerative low-NO_x burners have been developed, combining the regeneration with coupled gas and air staging, internal products of combustion, recirculation and flameless technologies. [31, EUROFER 10-7-18 2018]

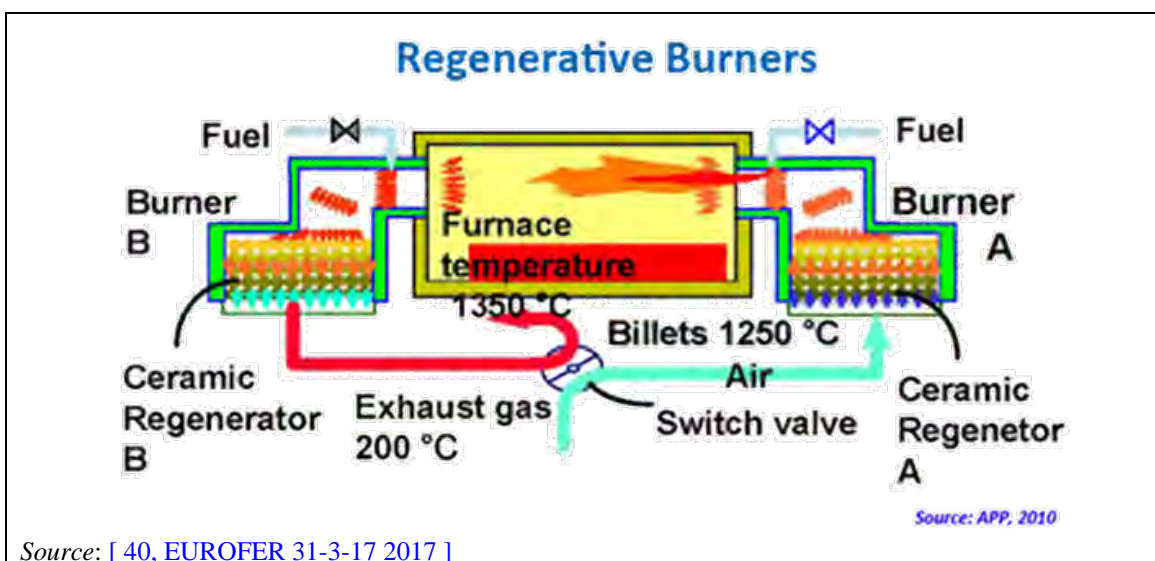


Figure 8.10: Schematic of a regenerative burner system

A special type of regenerative burner is the integral bed burner which has a more compact design as the regenerative bed is incorporated in the body of the burner. These types of burners are especially suitable for retrofitting furnaces where space constraints may be a problem and for small furnaces.

Recuperative burners

A recuperator is a heat exchanger fitted in the exhaust gas outlet, which allows heat to be transferred continuously through the heating surfaces to the incoming combustion air. Various equipment designs are available. Self-recuperative burners have integral heat exchangers for preheating combustion air. Figure 8.11 shows the schematic of a self-recuperative burner where the hot combustion products preheat the combustion air.

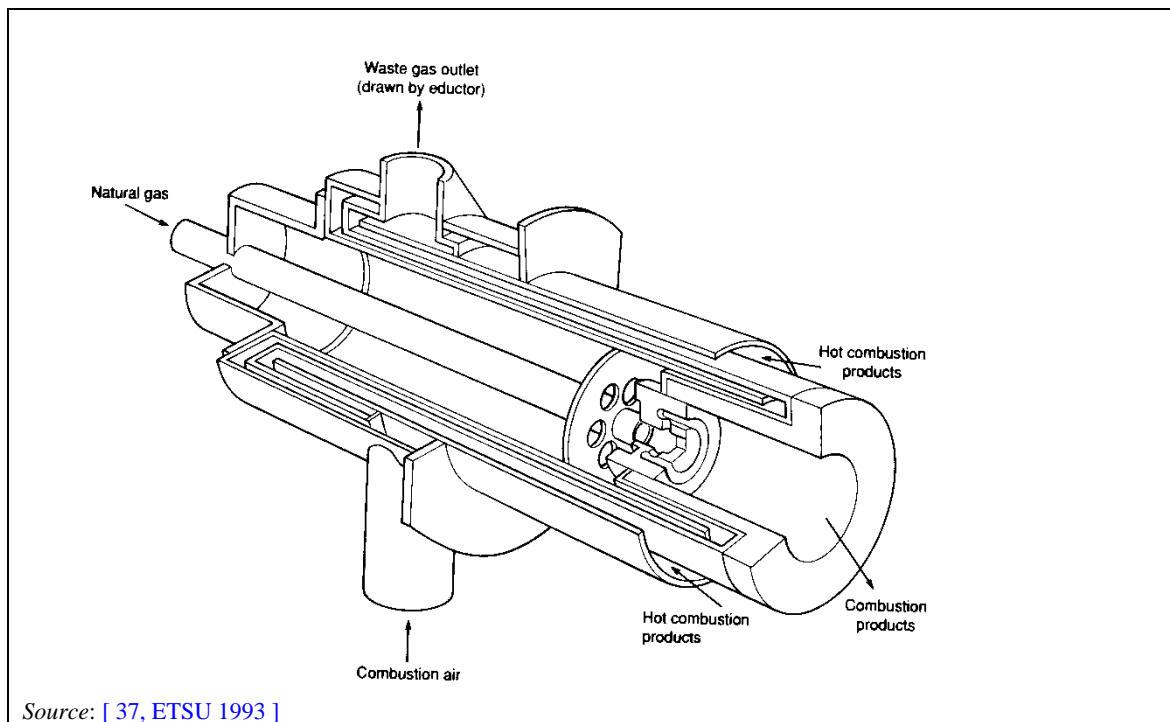


Figure 8.11: Schematic of a self-recuperative burner

There are several types of recuperators:

- The radiation recuperator incorporates a cylindrical alloy steel tube bundle suspended within a refractory-lined outer shell (see Figure 8.12). These recuperators have proven to be reliable under adverse corrosion and fouling conditions. [31, EUROFER 10-7-18 2018]
- A convection recuperator is comprised of tube bundles with the tubes welded to the tube sheets to assure gas-tightness (see Figure 8.12). The tube arrangement, tube material and flow pattern are based on the specificities of each individual application, including temperatures, compositions, pressure drop limits and space availability. In a typical design, the hot waste gas from the furnace flows horizontally through the recuperator, passing outside of vertical tubes. Combustion air flowing to the burners makes two or more passes inside the tubes in a counter cross-flow pattern. [31, EUROFER 10-7-18 2018]

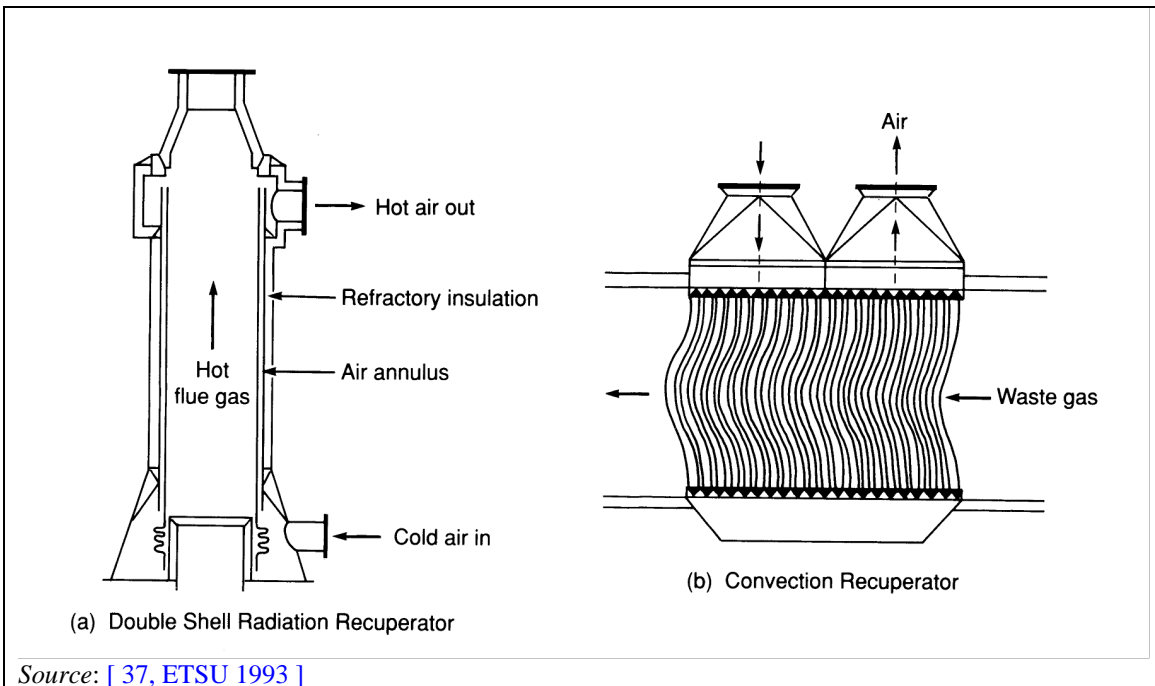


Figure 8.12: Typical exhaust gas recuperators

More complex designs of a recuperator can enlarge the heat exchange surface by creating a more compact heat transfer surface geometry. Figure 8.13 shows the schematic of a typical compact recuperator. [31, EUROFER 10-7-18 2018]

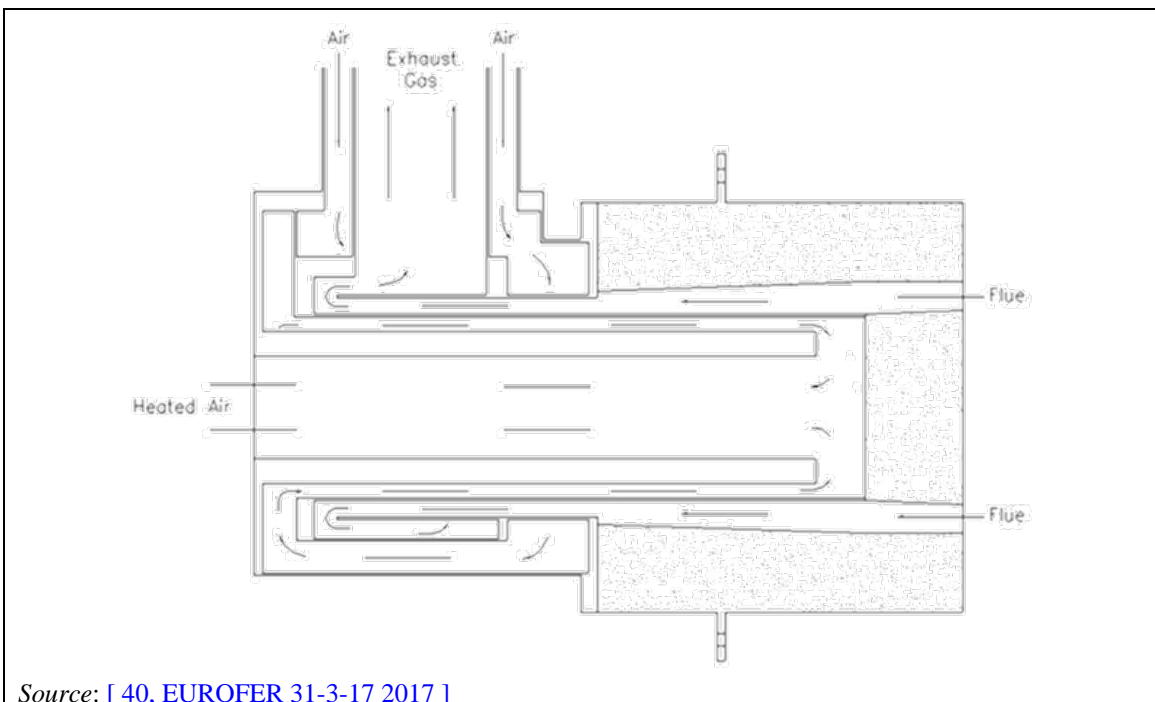


Figure 8.13: Typical compact recuperator

Achieved environmental benefits
 Reduced energy consumption.

Environmental performance and operational data

Regenerative burners

Regenerative burners can achieve air preheating temperatures of up to 1 100 °C but actual temperatures are dependent on the waste gas inlet temperature. Based on the air preheat temperatures, NO_x emissions can be as high as 3 000 mg/m³. [18, CITEPA 1994]

Regenerative systems are preferred for high waste gas temperatures to achieve air preheat temperatures above 600 °C. The air preheat temperature is limited by the process temperature and is generally 150–200 °C below the process temperature. A thermal efficiency of the furnace of 80 % and fuel savings of up to 60 % can be achieved. [4, EUROFER 1998], [89, EUROFER, TG Cold Rolling 1998]

A regenerative system is particularly attractive for batch processes because they do not generally contain a preheat zone. In continuous furnaces equipped with a central recuperator system, a similar thermal efficiency is reached by means of a long unheated (preheat) zone, where the heat of the flue-gases is transmitted by convection to the cold stock. [4, EUROFER 1998]

A specific design of compact regenerative burners has been developed for radiant tubes (Figure 8.14), with specific application for continuous annealing lines or the heating zones of galvanising lines. [31, EUROFER 10-7-18 2018]

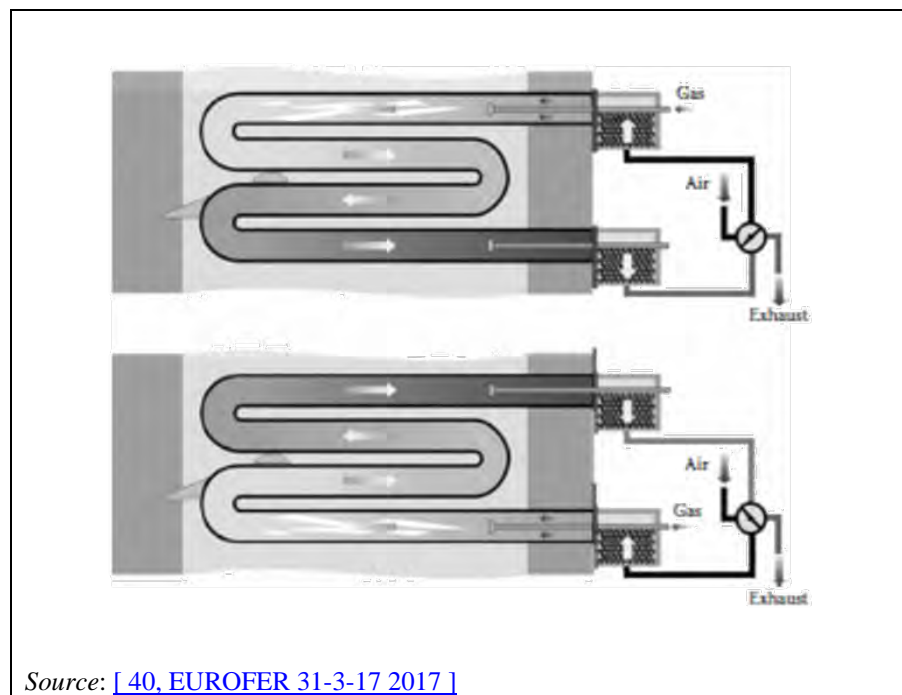


Figure 8.14: Schematic of a regenerative burner system in radiant tubes

Recuperative burners

Recuperating the heat of flue-gases allows an air preheat temperature up to 550 °C or 620 °C depending on the process temperature. Higher air preheat temperatures are technically possible, but entail additional costs due to the heat-resistant construction materials that would be required. A thermal efficiency of approximately 65 % can be reached. [4, EUROFER 1998]

Recuperative burners can be used in high-temperature processes (700–1 300 °C). [31, EUROFER 10-7-18 2018]

Recuperation combined with additional techniques results in advanced burner designs with effects on emissions. A recuperative radiant tube burner used for indirect heating of the load is shown in Figure 8.15. The high velocity of the combustion gases generates a pressure at the

outlet of the ceramic burner tube, resulting in the recirculation of the flue-gases. This leads to the reduction of NO_x emissions and a uniform radiant tube temperature. The maximum air preheat temperature is approximately 700 °C. A recuperative burner using staged combustion can lead to low NO_x emissions. [31, EUROFER 10-7-18 2018]

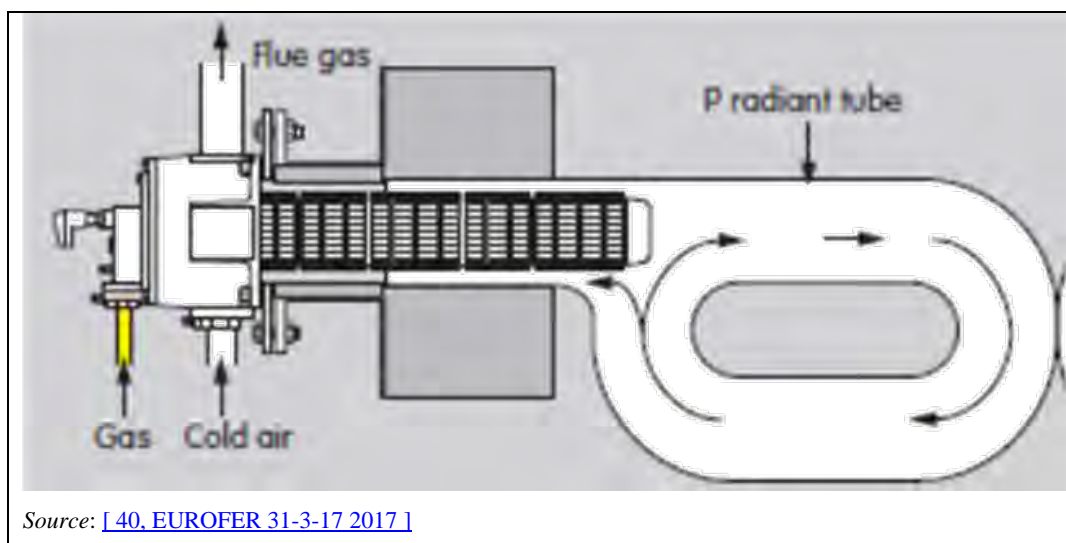


Figure 8.15: Typical recuperative burner in radiant tubes

Cross-media effects

Thermal NO_x generation can be increased.

Technical considerations relevant to applicability

Applicability to existing plants may be restricted by a lack of space for the installation of regenerative burners.

Economics

No information provided.

Driving force for implementation

Increased energy efficiency.

Example plants

Widely used.

Reference literature

[4, EUROFER 1998], [18, CITEPA 1994], [31, EUROFER 10-7-18 2018].

8.5.4.4 Waste heat recovery boiler

Description

The heat from hot flue-gases is used to generate steam or hot water that is used in other processes (e.g. for heating pickling and fluxing baths), for district heating or for generating electricity.

Technical description

The waste heat recovery boiler can be installed directly after the furnace exit or after a recuperator unit. With this technique, the heat content of the hot exhaust gases is used to generate steam (Figure 8.16). Hot exhaust gases pass through several heat exchanger units and heat is transferred to the water/steam cycle. The economiser and evaporiser are used to heat up the condensate and generate steam. Additional superheater units can be installed to generate

overheated steam. Depending on the operation conditions, the exhaust gas can be cooled down to around 200 °C, but lower temperatures would lead to condensation in the chimney and therefore must be avoided. [25, EUROFER 2018]

The generation of steam by this method at this point saves generating this energy elsewhere (e.g. in the power plant or heating station). As a result, considerable energy and emission reductions can be achieved, providing that there is a need for the quantity of steam produced and over the time period when it is produced. [25, EUROFER 2018]

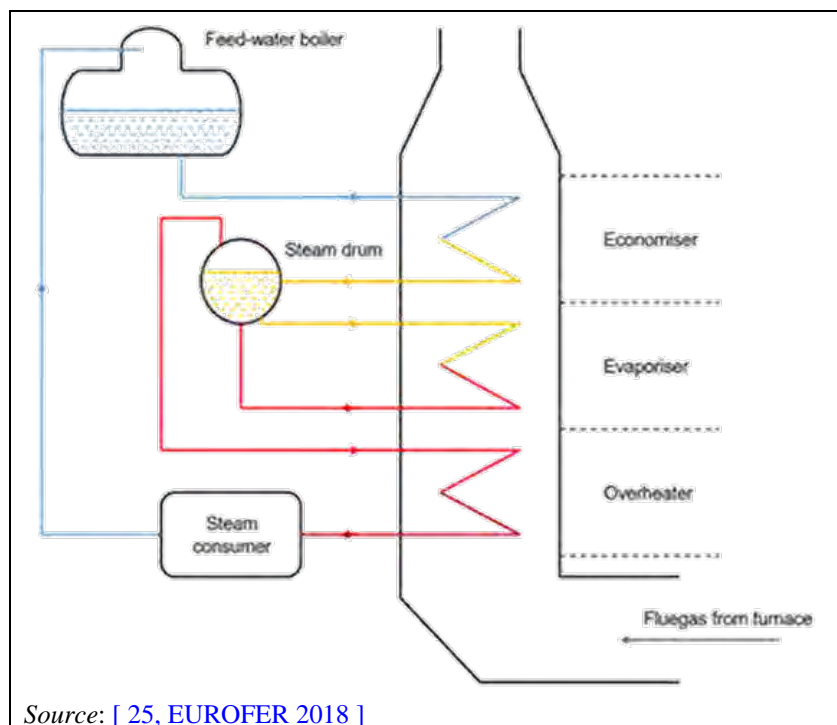


Figure 8.16: Basic schematic of a waste heat recovery boiler

The steam generated can be used within the rolling mill for heating systems or outside the rolling mill to produce electrical energy in the power plants or for municipal long-distance heating systems. [4, EUROFER 1998]

Achieved environmental benefits

By generating steam, the thermal potential of the waste heat stream can be used to supply other processes in the plant and therefore decrease the overall primary fuel consumption. [25, EUROFER 2018]

Environmental performance and operational data

Table 8.3: Operational data of the waste heat recovery boiler at reference plant Voestalpine Stahl GmbH (hot strip rolling mill)

Location	Steam generator producing overheated steam using the exhaust gases from two pusher-type furnaces
Steam pressure	18 bar
Steam temperature	320 °C
Capacity	65 t/h
Investment costs:	EUR 4.5 million
Energy recovery	(8 % of fuel consumption)
Use of steam	Steam network

Source: [25, EUROFER 2018]

The steam-generating process is applied between points of high thermodynamic potential. In the hot rolling process, only the heat treatment furnaces provide a sufficient thermal gradient to operate a practical waste heat steam boiler. [\[25, EUROFER 2018 \]](#)

The effectiveness of the waste heat boiler and recuperator decreases when they are installed for the same exhaust gas stream. [\[25, EUROFER 2018 \]](#)

Cross-media effects

None.

Technical considerations relevant to applicability

Applicability to existing plants may be restricted by a lack of space and/or a suitable steam or hot water demand.

Economics

With heat recovery systems, fuels can be substituted, which leads to a monetary advantage. The installation of a waste heat recovery boiler is only practical when there is a significant and continuous demand for steam. In an integrated steel plant, there is mostly a surplus of heat and a fast amortisation of the investment cannot be expected.

Investment costs depend on the heat capacity, location and accessibility of the furnaces, the type of steam requirements and the existing steam network. Long distances to the purchaser or the steam network significantly increase the investment and maintenance costs for transportation.

Additional expenses for maintenance, process control and operating costs must be taken into account. Possible further costs may be needed for the transport of steam to users (if not already available). [\[25, EUROFER 2018 \]](#)

Driving force for implementation

Energy savings.

Example plants

Voestalpine Stahl GmbH hot strip rolling mill.

Reference literature

[\[4, EUROFER 1998 \]](#), [\[25, EUROFER 2018 \]](#).

8.6 Material efficiency

8.6.1 Techniques to increase material efficiency in degreasing

8.6.1.1 Use of feedstock with low oil and grease contamination

Description

The use of feedstock with low oil and grease contamination prolongs the lifetime of the degreasing solution.

Technical description

Customers of galvanising plants are informed to oil and grease their items as little as possible. Reducing the oil/grease input is a cheap, easy and effective technique to prolong the lifetime of degreasing baths and thus reduce the amount of waste generated (spent bath and oily sludge).

Achieved environmental benefits

- Increased material efficiency.
- Reduced waste water and sludge.

Environmental performance and operational data

No information provided.

Cross-media effects

None.

Technical considerations relevant to applicability

Applicability may be limited if the feedstock quality cannot be influenced.

Economics

No information provided.

Driving force for implementation

Reduced costs due to increased material efficiency.

Example plants

Widely used.

Reference literature

No reference literature provided.

8.6.1.2 General techniques for increased degreasing efficiency

Description

This includes techniques such as:

- monitoring and optimising the temperature and the concentration of degreasing agents in the degreasing solution;
- enhancing the effect of the degreasing solution on the feedstock (e.g. by moving the feedstock, agitating the degreasing solution or by using ultrasound to create cavitation of the solution on the surface to be degreased).

Technical description

Monitoring of bath parameters such as temperature and concentration of degreasing agent can be used for optimising degreasing activities and thus make efficient use of the degreasing bath. Furthermore, degreasing efficiency can be improved by enhancing the contact between the

liquor and the feedstock: e.g. by moving the feedstock, by moving the bath (agitation) or by using ultrasound.

Achieved environmental benefits

- Increased material efficiency.
- Reduced waste water and sludge.

Environmental performance and operational data

Plants 166, 167 and 168 report analysing the degreasing bath parameters every month. [[16, FMP TWG 2018](#)]

Cross-media effects

Increased energy consumption by moving the feedstock, agitating the solution or ultrasonic cleaning.

Technical considerations relevant to applicability

Generally, there are no technical restrictions to the applicability of this technique.

Economics

No information provided.

Driving force for implementation

Reduced costs due to increased material efficiency.

Example plants

Plants from the data collection: 166, 167 and 168.

Reference literature

[[16, FMP TWG 2018](#)].

8.6.1.3 Minimisation of drag-out of degreasing solution

Description

This includes techniques such as:

- using squeeze rolls, e.g. in the case of continuous degreasing of strip (see Section 5.4.1.1.4);
- allowing for a sufficient dripping time, e.g. by slow lifting of workpieces (see Section 6.4.1.1).

8.6.1.4 Reverse cascade degreasing

Description

Degreasing is carried out in two or more baths in series where the feedstock is moved from the most contaminated degreasing bath to the cleanest.

More information on the technique

See Sections 3.4.3.1 and 5.4.1.1.1.

8.6.1.5 Cleaning and reuse of the degreasing solution

Description

Magnetic separation, oil separation (e.g. skimmers, discharge launders, weirs), micro- or ultrafiltration or biological treatment is used to clean the degreasing solution for reuse.

Technical description

High oil contents make degreasing solutions unusable and cleaning measures are applied to extend the lifetime of the bath using different types of cleaning circuits employing mechanical cleaning, magnetic separators/filters, adsorption of surfactants and oils, membrane filtration.

Mechanical cleaning

Usually the emulsions of degreasing agents and oil/grease from the metal surface are unstable and after some time they float on the surface of the bath in calm areas. Calm areas can be achieved by special design features of the degreasing tank or if this is not possible, e.g. when the degreasing solution is sprayed, by introducing a special calm tank where the solution can settle. The floating oil and grease can be removed by **skimmers, discharge launders, weirs** etc.

With these measures, simply using natural gravity (separating time: about 2 hours), the lifetime of degreasing baths can be prolonged by two or four times. The sludge withdrawn contains oils, grease, degreasing agent, scale, rust, dust, etc. and is usually disposed of. [71, Fichtner 1994], [144, ABAG 1993]

Separation is more effective using **centrifuge separators** or hydrocyclones, which split the oil and water phases within seconds. Very small oil and grease drops are separated more easily; the oil-rich part contains only 5–10 % water and unwanted carry-over of degreasing chemicals is prevented. The lifetime of the baths can be prolonged by up to 16 times. [144, ABAG 1993]

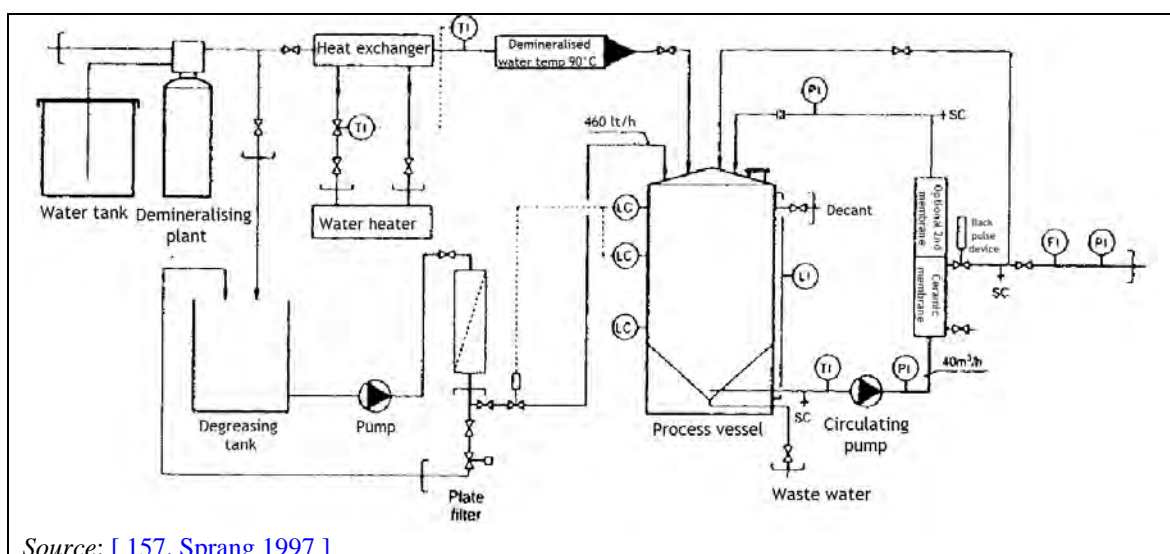
Magnetic separators/filters

Magnetic separators can be used to remove the mixture of iron fines and oil from degreasing baths.

Membrane filtration

In **micro- and ultrafiltration** (see also Figure 8.53) the degreasing bath is pumped through membranes (at a pressure of 3–8 bar) in which oil, grease and spent surfactants are held back due to the size of the molecules. To protect the membranes, the degreasing liquid is usually cleaned from particles in a settling tank or by other means first. Micro- and ultrafiltration increase the lifetime of the bath by 10 to 20 times. [144, ABAG 1993]

Figure 8.17 shows the flow sheet of such a filtration plant. In regular production, the degreasing liquid is pumped out of the bath into a standard plate filter where all solid particles are removed. The filtrate then goes on to a storage vessel, also known as a circulation vessel. The vessel contains the concentrated degreasing solution. [157, Sprang 1997]



Source: [157, Sprang 1997]

Figure 8.17: Example flowsheet for ceramic filtration of degreasing solution

A second pump forces the degreasing solution through the membrane section at high speed and pressure (approximately 2.5 bar). The free oil and oil dissolved by the surfactant are filtered out by the membrane while the clear liquid and free surfactants flow through it and back into the degreasing bath. Thus, any oil that forms is removed during the course of normal production. Liquid circulates through the storage vessel and concentrates over time. When the oil concentration is high enough the unit is turned off and the liquid (oil and water) in the storage vessel allowed to settle. After a period of time, a two-stage process takes place: the oil is separated from the water phase and, to recycle the active surfactants, a thermal treatment is employed in the second stage. This thermal treatment causes the surfactant to release the oil trapped in it and to separate into two phases. Separation is highly effective and high-grade oil is recovered. [157, Sprang 1997]

Achieved environmental benefits

- Increased material efficiency.
- Reduced waste water and sludge.

Environmental performance and operational data

Table 8.4 presents input/output data and effluent data for degreasing solution cycle of a continuous annealing line, which is maintained by cleaning via **ultrafiltration**.

Table 8.4: Operational and effluent data for degreasing bath cleaning by ultrafiltration

Input / Consumption Level				
Degreasing solution		50 - 60	kg/t	
Demineralised water		0.3 - 0.4	kg/t	
Degreaser		0.04 - 0.05	kg/t	
Tempering fluid concentrate		0.15 - 0.2	kg/t	
Electrical energy		4 - 5	MJ/t	
Output / Emission Level				
Cleaned degreasing solution		40 - 50	kg/t	
Sludge		0.4 - 0.5	kg/t	
	Concentration [mg/l]	Specific Emission [g/t product]	Reduction rate ¹ [%]	Method of analysis
Suspended solids (filterable)	20 - 40	2.35 - 4.7 E -4	> 90	DIN 38409-H2
Σ Hydrocarbons (oil, grease)	5 - 8	5.9 - 9.4 E -5	> 90	DIN 38409-H18
Fe total	1 - 2	1.2 - 2.4 E -5	> 90	DIN 38406
Temperature	30 °C	NI	NI	Thermometer
pH	6.5 - 9.5	NI	NI	NI
¹ Based on mass flow of constituent. NB: NI = No information provided. Source: [89, EUROFER, TG Cold Rolling 1998]. Data based on weekly, volume proportional 24-h sampling.				

All techniques described above to prolong the lifetime of degreasing baths can be used in the case of alkaline or acidic degreasing baths, but the efficiency in acidic degreasing baths is reduced due to the more stable emulsions formed. [144, ABAG 1993]

Cross-media effects

Increase in energy consumption when using centrifuges, micro- or ultrafiltration.

Oil and grease arise as waste in the cleaning of degreasing solutions. This waste may be used for energy recovery or has to be disposed of by incineration.

Technical considerations relevant to applicability

Generally, there are no technical restrictions to the applicability of this technique.

The membranes (pore size) have to be adjusted to the characteristic of the degreasing bath and have to match the cleaning requirements for each individual bath. With the ever changing conditions usually observed in job galvanising (i.e. variations in contents, surfactants, oils, grease etc.), operational problems occur, like clogging, fouling and damage to the membrane. [[144, ABAG 1993](#)] Appropriate membranes and specific bath chemistry have yet to be developed to allow application in batch hot dip galvanising. [[80, DE, TWG member 2000](#)]

Economics

No information provided.

Driving force for implementation

Reduced costs due to increased material efficiency.

Example plants

Widely used.

Reference literature

[[16, FMP TWG 2018](#)], [[71, Fichtner 1994](#)], [[80, DE, TWG member 2000](#)], [[144, ABAG 1993](#)], [[157, Sprang 1997](#)].

8.6.2 Techniques to increase material efficiency in pickling

8.6.2.1 Acid heating with heat exchangers or by submerged combustion

Description

Acid heating is carried out with heat exchangers or by submerged combustion:

- corrosion-resistant heat exchangers are immersed in the pickling acid for indirect heating, e.g. with steam;
- combustion gases pass through the pickling acid, releasing the energy via direct heat transfer.

Technical description

In principle two techniques are available: **heat exchangers** and **submerged combustion** (immersion gas burner) for heating acid baths. The formerly applied technique of steam injection (e.g. for heating acid baths), is not considered here as it leads to unnecessary dilution of process baths. The principles of both, heat exchanger and submerged combustion, are shown in Figure 8.18 and Figure 8.19.

In heat exchangers, the heating media and the liquid to be heated are separated by a partition and no mixing (or contamination) takes place. With the immersion of gas burners, hot flue-gas is blown directly into the liquid to be heated and both are mixed. Either heating technique has advantages and disadvantages and their application depends to some extent on the individual situation of a plant.

Where waste heat is available in the form of steam or in the form of another heating medium with a lower temperature, heat exchangers are commonly used. Several designs of heat exchangers exist, tube or plate, and depending on the chemical properties of the product to be heated and/or the heating media, high quality material has to be used. Heat exchangers need large surfaces to achieve the heat transfer.

If fuel gas is readily available or steam has to be produced first, it might be sensible to use a burner to heat the liquid directly and thus increase the thermal efficiency. Disadvantages are that the product may be contaminated with CO₂, SO₂, NO_x etc., which could cause problems, and

that portions of the product (e.g. acid vapour, droplets) may be carried out with the flue-gas, making a waste gas treatment necessary. [27, Van Roosbroeck 1999]

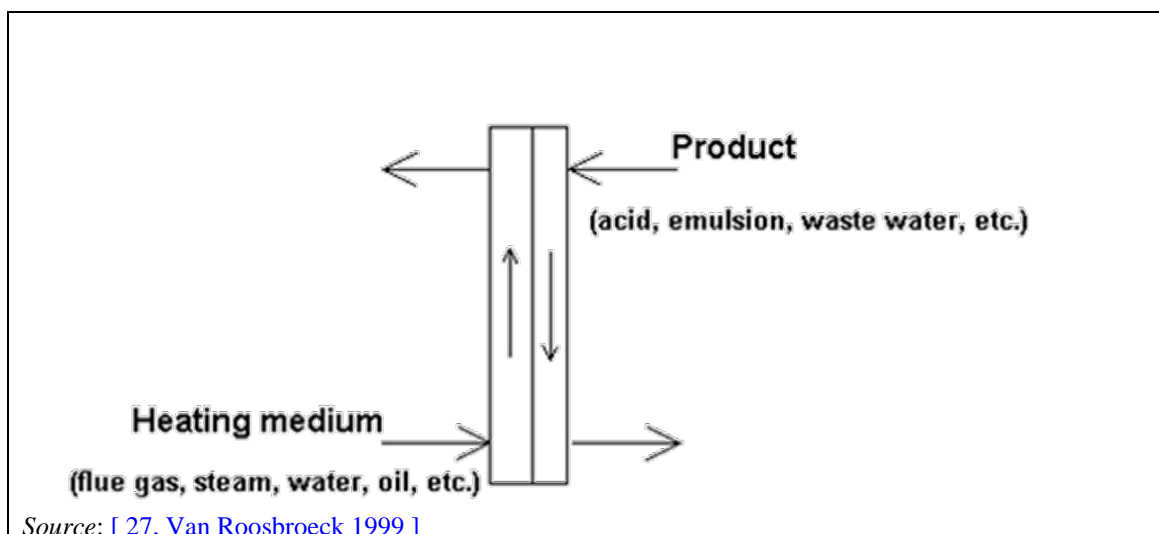


Figure 8.18: Principle of heat exchangers

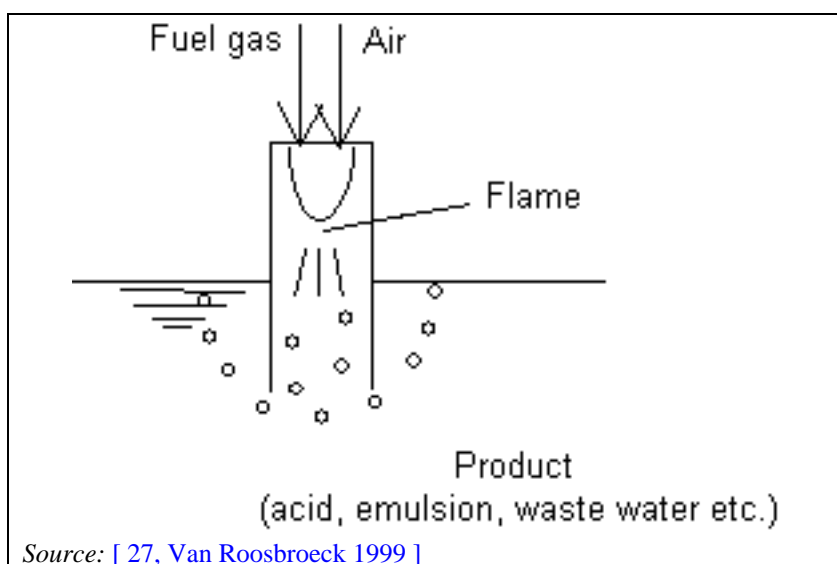


Figure 8.19: Principle of submerged combustion

Some advantages of submerged combustion were reported, besides financial savings, reduced energy consumption and acid consumption have been reported.

Achieved environmental benefits

- The direct injection of steam to heat the pickling acid is avoided.
- Increased material efficiency.

Environmental performance and operational data

No information provided.

Cross-media effects

None.

Technical considerations relevant to applicability

Generally, there are no technical restrictions to the applicability of this technique.

Economics

No information provided.

Driving force for implementation

- Savings in acid consumption.
- Increased effectiveness of pickling operations.

Example plants

Widely used.

Reference literature

[[27, Van Roosbroeck 1999](#)].

8.6.2.2 Minimisation of steel corrosion**Description**

This includes techniques such as:

- cooling the hot rolled steel as fast as possible depending on product specifications;
- storing the feedstock in roofed areas;
- limiting the storage duration of the feedstock.

Technical description

General techniques are employed to minimise steel corrosion of the hot rolled product and reduce or avoid the need for pickling. Indeed, the acid consumption during pickling is proportional to the amount of iron oxide removed from the steel surface. These techniques include the following:

- Reduction of iron oxide formation during hot rolling and steel handling (e.g. by high-pressure descaling, fast cooling).
- Short storage time of the feedstock in corrosion-free storage areas.
- The acid consumption during pickling is proportional to the amount of iron oxide removed from the steel surface. Although the potential for a reduction in oxide formation is limited, control of the cooling rate can modify the structure of the scale. This can influence the pickling speed and thus reduce energy consumption for the process. Fast cooling of the hot rolled strip may be limited however for quality reasons.

Achieved environmental benefits

Reduce the generation of spent pickling acid.

Environmental performance and operational data

No information provided.

Cross-media effects

None.

Technical considerations relevant to applicability

Generally, there are no technical restrictions to the applicability of this technique.

Economics

No information provided.

Driving force for implementation

Reduced costs due to increased material efficiency.

Example plants

Widely used.

Reference literature

No reference literature provided.

8.6.2.3 Mechanical predescaling**Description**

This includes techniques such as:

- shot blasting;
- bending;
- sanding;
- brushing;
- stretching and levelling.

Technical description

Mechanical predescaling techniques, like shot blasting, bending, sanding, brushing, stretcher leveller, temper mill or leveller, are used to break and remove the major portion of the hot rolling scale. As the amount of iron oxide that has to be removed from the steel surface in the chemical pickling section is reduced, the acid consumption is reduced. Mechanical predescaling facilities are equipped with extraction systems and abatement devices (generally fabric filters) to control the release of particulate material.

For the application of bending in wire drawing see Section 4.4.1.1.

Achieved environmental benefits

Reduction of acid consumption.

Environmental performance and operational data

Table 8.5: Dust emission levels achieved at shot blasting units using fabric filters (mechanical predescaling before pickling)

Substance	Concentrations reported over 3-year period - (mg/Nm ³)					Number of plants/ number of measurements
	Average	Median	90 th percentile	Min.	Max.	
<u>Carbon steel</u>						
Dust	1.9	0.9	4.9	0.05	5.0	8 / 27
<u>Stainless steel</u>						
Dust	2.6	2.8	3.6	1.2	7.3	5 / 11
Pb	0.0016	0.0016	0.002	0.0003	0.003	2 / 10
Ni	0.05	0.02	0.08	0.001	0.016	4 / 14

- Due to increased effectiveness of the pickling operations, pickling bath temperatures can be lowered, resulting in lower evaporation losses. Reducing the loading on the acid pickling and hence the consumption of acids decreases the generation of acidic wastes.
- Mechanical predescaling for stainless steel grades can only be applied prior to the initial pickling step. In later pickling steps, this would influence the surface quality of the finished product.

Cross-media effects

- Increased energy consumption.
- Generation of particulate emissions which have to be captured and abated.
- Generation of waste (filter dust).

Technical considerations relevant to applicability

- Applicability to existing plants may be restricted by a lack of space.
- Applicability may be restricted due to product specifications.

Economics

No information provided.

Driving force for implementation

- Savings in acid consumption.
- Increased effectiveness of pickling operations.

Example plants

Outokumpu Nirosta GmbH, Plant 144 CR (horizontal shot blasting for hot and cold strip, fabric filter). [[178, Anstots et al. 1994](#)]

Other example plants in the data collection using fabric filters include: 88 CR, 110 CR, 158 CR, 238 CR.

Reference literature

[[18, CITEPA 1994](#)], [[89, EUROFER, TG Cold Rolling 1998](#)], [[178, Anstots et al. 1994](#)], [[179, Finland, TWG member 1998](#)].

8.6.2.4 Electrolytic prepickling for high-alloy steel**Description**

Use of an aqueous solution of sodium sulphate (Na_2SO_4) to pretreat high-alloy steel before pickling with mixed acid, in order to speed up and improve the removal of the surface oxide scale. The waste water containing hexavalent chromium is treated by chemical reduction (see BAT 31 (f) related to Section 8.9.4 and/or Section 3.4.1.14).

Technical description

In the production of stainless steel, electrolytic prepickling with a neutral electrolytic solution of sodium sulphate (Na_2SO_4) is used as a pre-processing technique, at a maximum processing temperature of 80 °C, prior to mixed acid pickling (with HF/HNO_3) in order to speed up the removal of the surface oxide scale which develops during annealing. This process provides fast pickling rates and reduces over-pickling. [[180, Ipek et al. 2005](#)]

Other developments include alkaline electrolytic prepickling in combination with neutral prepickling and acidic pickling / acidic electrolysis.

Achieved environmental benefits

- Reduction of the load on the mixed acid pickling line and hence a reduction in NO_x and nitrate releases.
- Wet scrubbing techniques using packed towers are generally employed to reduce the emissions to air from prepickling facilities.

Environmental performance and operational data

Electrolytic prepickling facilities are fully sealed; fumes are extracted and led to a scrubber unit before release.

During the pickling process, insoluble salts and metalics are formed and must be removed from the electrolytic sodium sulphate solution to maintain proper operation. Accordingly, a small side stream of the electrolyte is cleaned. Particulates in the solution are removed in inclined plate

clarifiers by gravity settling. The clarified solution is returned to the electrolysis tank while the sludge stream is sent to a chromium reduction unit.

Cross-media effects

Emissions to air and to water.

Technical considerations relevant to applicability

- Only applicable to cold rolling.
- Applicability to existing plants may be restricted by a lack of space.

Economics

No information provided.

Driving force for implementation

Reduction of pickling time at the mixed acid pickling line.

Example plants

Plants from the data collection: 26 CR, 88 CR, 144 CR, 232 CR.

Reference literature

[[180](#), [Ipek et al. 2005](#)].

8.6.2.5 Rinsing after alkaline degreasing

Description

Carry-over of alkaline degreasing solution to the pickling bath is reduced by rinsing feedstock after degreasing.

Technical description

The amount of solution carried out of degreasing baths and into the following pickling process can be minimised by allowing enough time for the solution to drip off, but especially by implementing a rinse step.

Achieved environmental benefits

Reduction of the generation of spent pickling acid.

Environmental performance and operational data

No information provided.

Cross-media effects

Generation of waste water.

Technical considerations relevant to applicability

Applicability to existing plants may be restricted by a lack of space.

Economics

No information provided.

Driving force for implementation

Reduced costs due to increased material efficiency.

Example plants

Widely used.

Reference literature

No reference literature provided.

8.6.2.6 General techniques for increased pickling efficiency

Description

These include techniques such as:

- optimisation of the pickling temperature for maximising pickling rates while minimising emissions of acids;
- optimisation of the pickling bath composition (e.g. acid and iron concentrations);
- optimisation of the pickling time to avoid over-pickling;
- avoiding drastic changes in the pickling bath composition by frequently replenishing it with fresh acid.

Technical description

The acid concentration can be reduced by using high pickling temperatures. The optimum is a function of acid losses, pickling efficiency and energy consumption. Increasing the pickling temperature leads to a rise in NO_x generation for stainless steel pickling and therefore avoiding excessive NO_x formation needs to be considered in the balance.

The pickling efficiency, and thereby the necessary pickling time, changes during the lifetime of the bath. As the bath gets older, the iron concentration increases significantly, and less free acid is needed to keep the same pickling velocity as initially. Drastic changes in the pickle liquor, e.g. by replacing large volumes of the bath, may lead to unknown pickle conditions which may result in over-pickling. Discharge of spent pickle liquor and addition of fresh acid in more frequent but small doses avoids drastic changes in bath characteristics and allows for smooth operation.

Achieved environmental benefits

- Reduction of the generation of spent pickling acid.
- Less over-pickling (associated with less waste).

Environmental performance and operational data

Careful monitoring of bath parameters (acid concentration, iron content etc.), can help in optimising the operation, e.g. by shortening the pickling time to avoid over-pickling.

Cross-media effects

None.

Technical considerations relevant to applicability

Generally, there are no technical restrictions to the applicability of this technique.

Economics

No information provided.

Driving force for implementation

Reduced costs due to increased material efficiency.

Example plants

Widely used.

Reference literature

No reference literature provided.

8.6.2.7 Cleaning of the pickling bath and reuse of free acid

Description

A cleaning circuit, e.g. with filtration, is used to remove particles from the pickling acid followed by reclamation of the free acid via ion exchange, e.g. using resins.

Technical description

Side-stream mechanical filtering, acid recovery and internal recycling can be used for cleaning and extending the lifetime of the pickling liquor. The liquor is filtered, e.g. in deep bed media filters, to remove particulates. Cooling of the acid by means of heat exchangers might be necessary prior to the adsorption unit in which a physico-chemical adsorbent (like a resin) removes free acid from the waste stream. Once the unit is saturated, the free acid is desorbed by a fresh water stream and recycled to the pickling process.

Achieved environmental benefits

Reduced acid consumption (waste water volume and sludge).

Environmental performance and operational data

This technique enables a constant composition of pickling acids to be easily maintained. [[25, EUROFER 2018](#)]

Cross-media effects

Increased energy consumption.

Technical considerations relevant to applicability

Not applicable if cascade pickling (or similar) is used, as this results in very low levels of free acid.

Economics

Savings are made because of a reduced consumption of acids. [[25, EUROFER 2018](#)]

Driving force for implementation

Reduced consumption of pickling acid.

Example plants

Outokumpu Germany Krefeld – Plant 144 CR [[25, EUROFER 2018](#)]

Other example plants in the data collection include 37 CR, 88 CR, 105 CR, 158 CR, 170 CR, 180 CR, 193 CR.

Reference literature

[[181, Brown C. 1999](#)].

8.6.2.8 Reverse cascade pickling

Description

Pickling is carried out in two or more baths in series where the feedstock is moved from the bath with the lowest acid concentration to the one with the highest.

Technical description

Cascade pickling is performed in two or more baths in series. The acid flows (continuously or discontinuously) countercurrently from one bath to the next. This allows a very efficient use of the acid while still achieving good pickling quality. [[118, B. Gielen, Bekaert 1998](#)]

Achieved environmental benefits

- Reduced consumption of fresh acid.
- Reduced spent acid (waste).

Environmental performance and operational data

No information provided.

Cross-media effects

None.

Technical considerations relevant to applicability

Applicability to existing plants may be restricted by a lack of space.

Economics

Costs include:

- larger building, including larger acid-proof floor surface and larger secondary containment;
- extra tank, circulation pump, and possibly extra exhaust system;
- more complex process control software for follow-up of pickling bath composition and level;
- different types of wire rod often require different contact times; if this is the case, specific process control software for scheduling and follow-up of the movements of the different rolls is also required.

Estimation: EUR 0.2–0.4 million depending on capacity.

Driving force for implementation

Reduced consumption of pickling acid.

Example plants

Widely used.

Reference literature

[\[118, B. Gielen, Bekaert 1998 \]](#)

8.6.2.9 Minimisation of drag-out of pickling acid**Description**

This includes techniques such as:

- using squeeze rolls, e.g. in the case of continuous pickling of strip;
- allowing for a sufficient dripping time, e.g. by slow lifting of workpieces;
- using vibrating wire rod coils.

Technical description

Minimising carry-over requires sufficient time for the acid to drip off the wire rod coils. This can be done by lifting the wire rod coil slowly from the last acid bath of the cascade and then allowing several seconds of dripping time above the acid bath before moving the wire rod coil to the first bath of the rinsing cascade. Dripping off can be enhanced for example by vibrating the wire rod coil.

Achieved environmental benefits

- Reduced fresh acid consumption.
- Reduced spent acid (waste).
- Reduced pickling loss.

Environmental performance and operational data

No information provided.

Cross-media effects

Energy needed for squeeze rolls and vibrating wire rod coils.

Technical considerations relevant to applicability

Generally, there are no technical restrictions to the applicability of this technique.

Economics

No information provided.

Driving force for implementation

Reduced consumption of pickling acid.

Example plants

Widely used.

Reference literature

No reference literature provided.

8.6.2.10 Turbulence pickling

Description

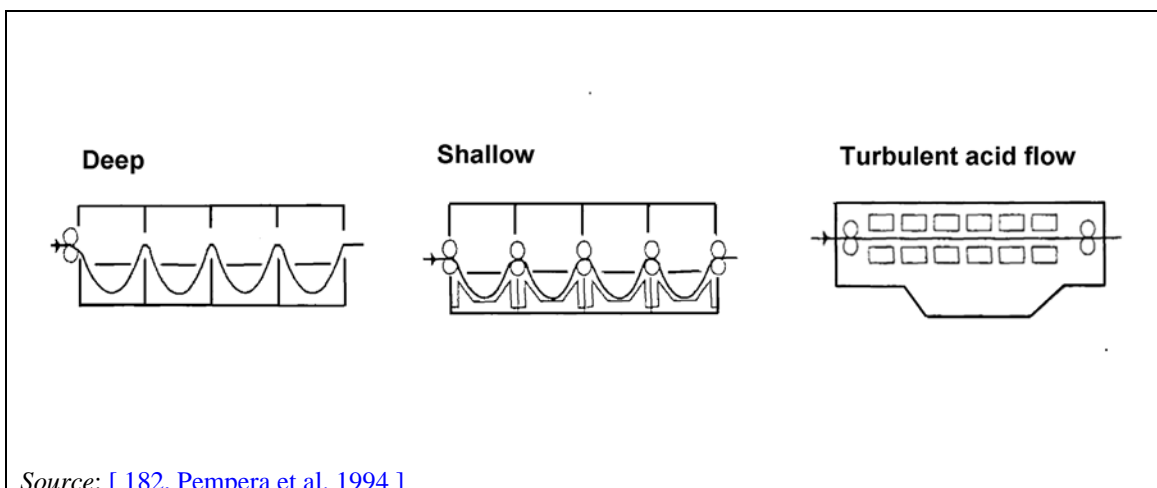
This includes techniques such as:

- injection of the pickling acid at high pressure via nozzles;
- agitation of the pickling acid using an immersed turbine.

Technical description

Figure 8.20 shows the development from deep pickling tanks via shallow tanks to turbulent pickling where the acid is sprayed onto the strip at the narrow gap between the pickling tanks. Turbulence pickling consists of injecting at high pressure using a series of nozzles the heated acid into the pickling channel along which the strip is passing. It results in a high level of turbulence, leading to maximum contact between the surface of the strip and the pickling acid. Using turbulence pickling, the acid is continuously forced into the cracks in the scale layer, facilitating the pickling process. As a result, the process is more efficient and lower temperatures are possible for the acid bath, leading to a reduction in acid consumption. [182, Pempera et al. 1994]

New acid consumption and/or regeneration capacities for spent acid are reduced. [182, Pempera et al. 1994]



Source: [182, Pempera et al. 1994]

Figure 8.20: Different types of pickling tanks

Turbulence pickling may also be achieved using an immersed turbine which agitates the pickling acid to reach a turbulent flow regime with a high Reynolds number. [148, IT 18-4-17 2017]

Achieved environmental benefits

- Reduction in acid consumption.
- Increased material efficiency.

Environmental performance and operational data

Injection of the pickling acid at high pressure via nozzles

As turbulence pickling is easier to control (and may be equipped with additional process models), a more effective control of the pickling effect is possible leading to less over-pickling and thus a reduction in pickling loss (20–30 % or 0.8–1.2 kg/t). [182, Pempera et al. 1994]

Agitation of the pickling acid using an immersed turbine

In one concrete case, an immersed turbine with an engine power equal to 7.5 kW was capable of circulating more than 5 000 m³/h of acid with a very low energy consumption. The agitating and recirculating system requires the use of a bath divided into two interconnected channels. A normal pickling tank is split into two compartments, one where the workpieces are actually pickled and the other the turbine is installed. Depending on the compartments and the volume of the workpieces, the speed of the pickling acid near the surface of the workpieces is more than 0.5 m/s. The geometric complexity of the workpieces immersed also helps to increase the speed of the pickling acid. The complete homogeneity of the flow of the pickling acid is guaranteed in both directions by the bidirectional action of the turbine. [148, IT 18-4-17 2017]

Cross-media effects

Increased energy consumption for high-pressure injection and for the operation of the turbine.

Technical considerations relevant to applicability

Applicability to existing plants may be restricted by a lack of space.

Economics

Low investment and operational costs.

Driving force for implementation

- Improvement of pickling process efficiency.
- Improved quality of the product.
- Savings in acid consumption.

Example plants

Plants from the data collection: 37 CR, 88 CR, 122 CR, 144 CR, 158 CR, 159 CR, 195 CR, 197 CR.

Reference literature

[182, Pempera et al. 1994]

8.6.2.11 Use of pickling inhibitors

Description

Pickling inhibitors are added to the pickling acid to protect clean metallic parts of the feedstock from over-pickling.

Technical description

To protect parts of the workpieces from over-pickling, pickling inhibitors are added to the pickling solution.

Achieved environmental benefits

- Reduced acid consumption.
- Less waste acid.

Environmental performance and operational data

Pickling inhibitors can reduce the material loss of the workpieces by up to 98 % and can reduce acid consumption by 10–20 %. [[183, EGGA - b 1999](#)]

However, these organic inhibitors could have a negative influence on subsequent acid recycling. Inhibitors can also have a detrimental effect on the surface quality (due to the formation of rust). [[144, ABAG 1993](#)]

Cross-media effects

Some pickling inhibitors may reduce the recycling options for waste acid.

Technical considerations relevant to applicability

- Not applicable to high-alloy steel.
- Applicability may be restricted due to product specifications.

Economics

Cost savings. [[184, EGGA - a 1999](#)]

Driving force for implementation

- Enhanced quality of product.
- Reduced operational costs.

Example plants

The vast majority (> 90 %) of all batch galvanising plants use pickling inhibitors. [[183, EGGA - b 1999](#)]

Reference literature

[[144, ABAG 1993](#)], [[183, EGGA - b 1999](#)], [[184, EGGA - a 1999](#)].

8.6.2.12 Activated pickling in hydrochloric acid pickling

Description

Pickling is carried out with a low hydrochloric acid concentration (i.e. around 4–6 wt-%), and a high iron concentration (i.e. around 120–180 g/l), at temperatures of 20–25°C.

Technical description

Pickling in hydrochloric acid with a low acid percentage and high iron content is referred to as activated pickling. For pickling steel with hydrochloric acid, the acid content is normally 10–12 % in order to achieve a reasonably quick pickling. However, at this acid percentage, the formation of hydrogen chloride is rather high. When using activated pickling, the acid percentage may be halved without affecting the pickling rate negatively, provided that the iron concentration is kept within 120–180 g/l. The temperature of the pickling bath needs to be maintained at 20–25 °C.

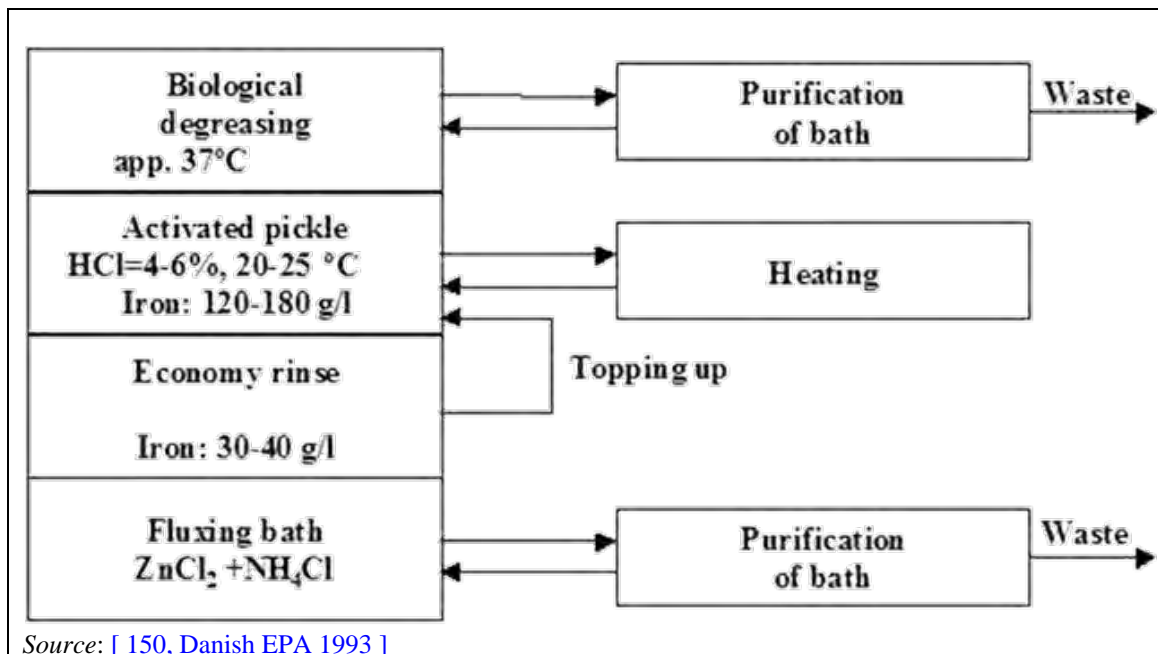
Achieved environmental benefits

- Reduced acid consumption.
- Prolonged lifetime of pickling baths and reduced generation of spent pickling liquor (liquid waste).
- Reduction of HCl emissions to air.

Environmental performance and operational data

Example Ferritslev Jernvarefabrik (FJ)

This system is used at Ferritslev Jernvarefabrik (FJ) where the pickling bath is kept almost free of zinc. The discarded baths can be utilised as precipitation agent at the municipal sewage treatment plant. FJ Varmforzinkning only has to pay the transport costs. [150, Danish EPA 1993]



Source: [150, Danish EPA 1993]

Figure 8.21: Flowsheet for activated pickling

After biological degreasing, the items are immersed directly into an activated pickling bath with 4–6 % hydrochloric acid and an iron content of 120–180 g/l. The items are suspended in black steel wires which are used only once. By doing so, zinc-coated suspension devices are prevented from entering the pickling bath. Furthermore, in a special stripping acid (4–7 % hydrochloric acid) zinc is stripped off items to be regalvanised. Thus, the zinc concentration in the pickling bath is kept at a very low level. [150, Danish EPA 1993]

There are four pickling tanks of 100 m³ each. From each tank 10 m³/h are circulated by means of a pump. The circulated volumes of water are mixed and pass through a heat exchanger before the water is returned to the individual tanks via a distribution system. In this manner, they take care of both heating and circulation in the pickling baths. [150, Danish EPA 1993]

It is important not to rinse between the biological degreaser and the pickler, since carry-over chemicals from the degreaser act as an inhibitor in the pickler, thereby preventing acid attack on the base material. [150, Danish EPA 1993]

After the pickling bath, rinsing is carried out in a so-called economy rinse which is used to dilute the pickling bath when part of it is to be discarded. Typically, the economy rinse has an iron content of 30–40 g/l and, consequently, it significantly reduces the carry-over of iron into the flux bath. [150, Danish EPA 1993]

Discarded stripping acid is delivered to Kommunekemi in the usual way. Discarded pickling acid is delivered to a firm which utilises it as precipitation agent in municipal sewage treatment plants. When they change the bath, they typically drain off 20 m³ of bath which is replaced by 10 m³ of hydrochloric acid and 10 m³ of water from the economy rinse. [150, Danish EPA 1993]

The production of hydrogen chloride in the acid hall is so low that even without extraction the hydrogen chloride content is 11–20 times below the occupational health and safety threshold value. Occupational environment measurements in the acid hall show hydrogen chloride concentrations in the air of 0.32–0.65 mg/m³. This is only 5–9 % of the threshold value for hydrogen chloride of the Danish Working Environment Service which is 7 mg/m³.

As activated pickling is introduced at the same time as biological degreasing and fluxing bath regeneration, it is difficult to quantify the financial advantages. In principle, extraction in the acid hall may be dispensed with. If they had extraction, air purification might be required. Their solution means that they can do without such equipment.

The service lifetime of the pickling baths increases by about 50 % when using activated pickling, because the bath is not discarded until it has an iron content of 180 g/l compared with the usual 120 g/l. It is cheap to get rid of the discarded pickling bath when it does not contain substantial quantities of zinc. The plant only has to pay for the transport to Kemira Miljø in Esbjerg where the discarded bath is reprocessed into precipitation agent. [[150, Danish EPA 1993](#)]

A heating system for the pickling baths is necessary when activated pickling is used, which means additional expense as compared with conventional pickling baths.

Cross-media effects

Increased energy consumption.

Technical considerations relevant to applicability

Generally, there are no technical restrictions to the applicability of this technique.

Economics

No information provided.

Driving force for implementation

Increased lifetime of the pickling baths.

Example plants

Widely used in batch galvanising.

Reference literature

[[150, Danish EPA 1993](#)].

8.6.3 Techniques to increase material efficiency in fluxing

8.6.3.1 Rinsing of workpieces after pickling

Description

In batch galvanising, carry-over of iron to the fluxing solution is reduced by rinsing workpieces after pickling.

Technical description

An excessive iron concentration in the flux bath causes drag-in of iron into the zinc bath. Each kg of Fe entering the zinc bath causes the loss of 25–30 kg Zn by formation of dross. Therefore, the iron content should be kept at a low level. [[118, B. Gielen, Bekaert 1998](#)]

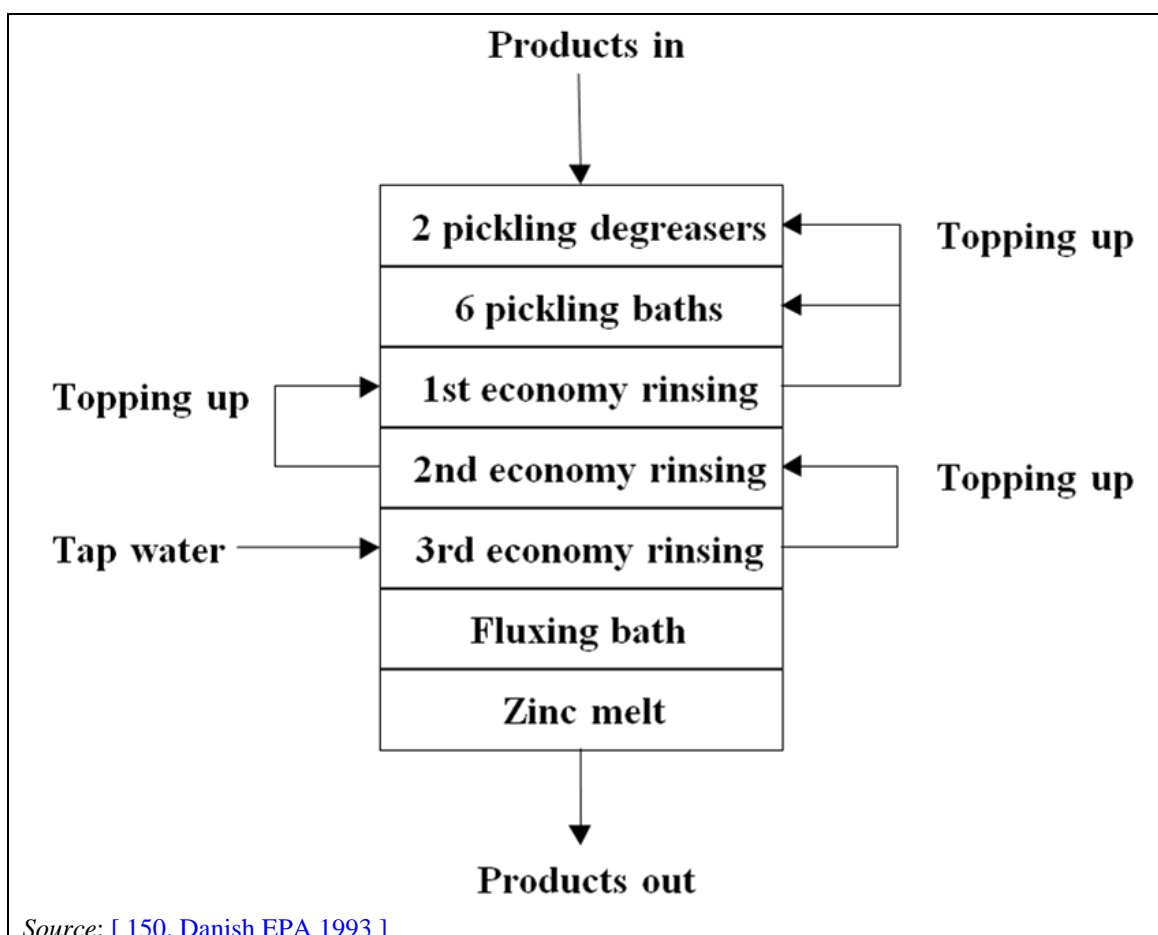
After pickling and ensuring the minimisation of drag-out of pickling solution (see Section 8.6.2.9), the feedstock is rinsed in water using a static rinse tank or reverse cascade rinsing.

Achieved environmental benefit

- Reduction of the generation of spent fluxing solution.
- Reduced waste (dross) and emissions in the subsequent galvanising step.

Environmental performance and operational data

As an example, the Herning Varmforzinkning plant uses 3 rinsing tanks without outlet after the pickling process (see Figure 8.22). Here, the pollution of the fluxing bath is reduced by 85 – 90 % resulting in a longer lifetime of the fluxing bath and less fluxing waste. The rinsing water flows countercurrent to the feedstock and is finally used as make-up water in the pickling baths. [150, Danish EPA 1993]



Source: [150, Danish EPA 1993]

Figure 8.22: Reverse cascade rinsing at a batch galvanising plant

The following average iron values were measured in pickling baths, rinsing tanks and fluxing baths: [150, Danish EPA 1993]

- Pickling bath: Iron = 75–85 g/l
- 1st economy rinse: Iron = 40–50 g/l
- 2nd economy rinse: Iron = 25–35 g/l
- 3rd economy rinse: Iron = approximately 10 g/l
- Fluxing bath: Iron = approx. 5 g/l

When the iron concentration in the fluxing bath reaches 10 g/l the bath is discharged into a road tanker and brought to the Vildbjerg factory equipped with a purification and regeneration system for fluxing baths. [150, Danish EPA 1993]

Cross-media effects

The rinsing water can be partially or completely used as make-up water for the pickling bath. In the case of a partial use, waste water is generated.

Technical considerations relevant to applicability

Applicability to existing plants may be restricted by a lack of space.

Economics

It is difficult to quantify the savings achieved. [\[150, Danish EPA 1993 \]](#)

Driving force for implementation

Reduced costs due to increased material efficiency.

Example plants

Herning Varmforzinkning A/S, Denmark [\[150, Danish EPA 1993 \]](#)

Reference literature

[\[118, B. Gielen, Bekaert 1998 \]](#), [\[150, Danish EPA 1993 \]](#).

8.6.3.2 Optimised fluxing operation

Description

The chemical composition of the fluxing solution is monitored and adjusted frequently. The amount of fluxing agent used is reduced to the minimum level required to achieve the product specifications.

Technical description

To make up for entrainment losses and to keep the concentration of flux baths constant, fluxing agents and water are added on a regular basis. The concentration of iron/iron chloride is monitored closely. This technique is not used in hot dip coating of sheets where fluxing is not carried out.

Achieved environmental benefits

Reduction of waste and avoidance of premature discarding of flux baths.

Environmental performance and operational data

To prevent carry-over of iron chlorides from pickling baths, the pickled workpieces should be rinsed thoroughly before fluxing. Nevertheless, a build-up of iron chloride cannot be prevented completely, so the flux solution has to be exchanged or regenerated periodically.

Cross-media effects

None.

Technical considerations relevant to applicability

Generally, there are no technical restrictions to the applicability of this technique.

Economics

No information provided.

Driving force for implementation

Increased lifetime of the fluxing baths.

Example plants

Widely used.

Reference literature

No reference literature provided.

8.6.3.3 Iron removal and reuse of the fluxing solution

Description

Iron is removed from the fluxing solution by one of the following techniques:

- electrolytic oxidation;
- oxidation using air or H₂O₂;
- ion exchange.

After iron removal, the fluxing solution is reused.

Technical description

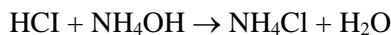
During operation, the iron concentration in a fluxing solution increases. At a certain level, the flux solution becomes unusable. In order to be able to recirculate the solution, the iron content needs to be removed. This can be done continuously or in batch operation. This technique is not used in hot dip coating of sheets where fluxing is not carried out.

Iron removal from the flux bath by aeration and precipitation of iron

The flux solution is aerated to assist iron precipitation and then the solution is decanted in order to remove the resulting sludge from the bottom of the tank. This operation has the advantage of reducing iron levels, although not to very low levels. [149, Wedge Group 2000]

Iron removal using ammonia and H₂O₂ oxidation

By means of addition of ammonia (for pH adjustment) and H₂O₂ (oxidant), iron is precipitated as Fe(OH)₃ and NH₄Cl is produced according to the reactions:



The precipitated iron hydroxide sludge is withdrawn and disposed of.

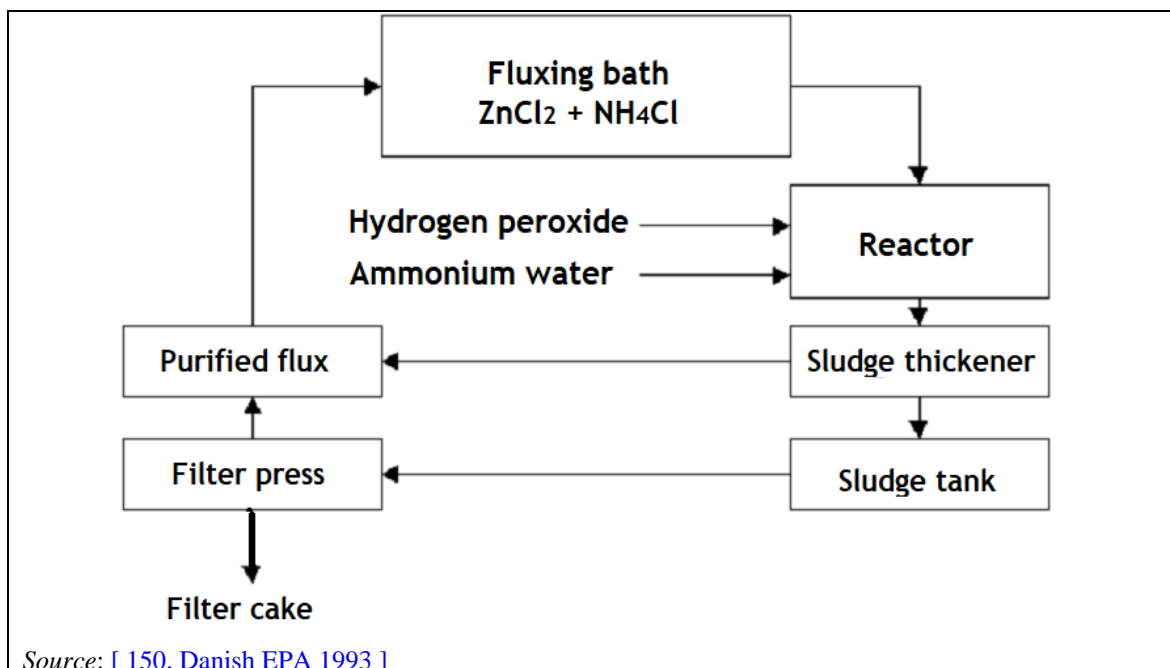
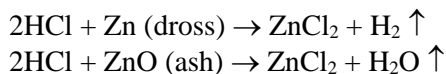


Figure 8.23: Flow sheet for flux regeneration

Zinc, initially present in solution or introduced by the workpieces impregnated with solution from the rinsing or pickling baths, remains as ZnCl₂.

Normally, the ratio of NH₄Cl/ZnCl₂ produced is higher than the ratio required by most galvanisers and the amount of salt produced is not sufficient to compensate for the consumption

of flux. This can be corrected by addition of depleted pickling or de-zincing solution, which increases the production of fluxing salts. Another option to influence the $\text{NH}_4\text{Cl}/\text{ZnCl}_2$ ratio of salts produced is to pre-react the depleted pickling or the de-zincing solution with dross or ash, thus producing ZnCl_2 instead of NH_4Cl :

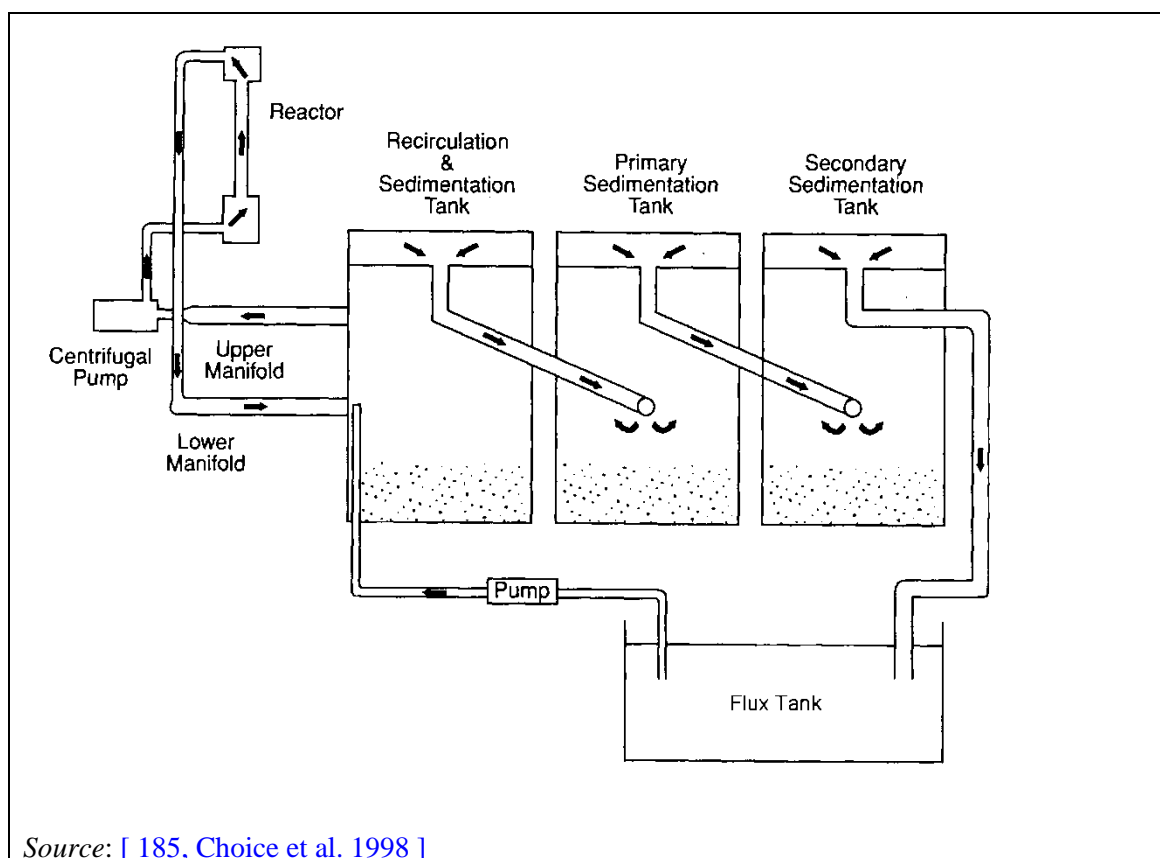


Automated pH and redox controls allow for a selective iron precipitation (about 50 % iron in the solids) and a low oxidising potential, avoiding the destruction of any organic additive in the flux. To obtain maximum thickening and filtration efficiency, a selective flocculant is added to the pulp in the flocculator, resulting in a high settling rate of solids, excellent clarity of the overflow and improved filtration characteristics of the underflow. A solid content of the press filter cake of around 50 % is achievable.

It is possible to generate flux solution with a composition required by the galvaniser. For an optimum composition of the flux, zinc chloride or ammonium chloride additions may be required. [150, Danish EPA 1993]

Iron removal using electrolytic oxidation

The electrolytic oxidation process consists of a reactor module or series of reactor modules for the electrolytic oxidation of dissolved iron and a set of sedimentation tanks for the removal of precipitate from the process stream. A schematic flow diagram is shown in Figure 8.24.



Source: [185, Choice et al. 1998]

Figure 8.24: Schematic of the electrolytic oxidation process

As the flux solution passes through the reactor, ferrous iron (II) is oxidised to ferric iron (III). The ferric iron (III) is precipitated as hydroxide. This is accompanied by the generation of acid. As a result, the concentrations of dissolved iron and acid capacity in the stream leaving the reactor are lower than in the entering stream. Because of this, and because work continues to

import rinse water or pickle solution to the main flux tank, the iron and acid capacity in the recirculation tank are lower than in the main flux tank. The relationship between the iron concentrations in the two tanks depends on a number of factors but, in practice, the concentration in the recirculation tank can be brought down to near zero grams per litre and steady concentrations in the main tank of less than 2 grams per litre can be achieved easily, while concentrations of 1 gram per litre or lower can be achieved with careful operation. [185, Choice et al. 1998]

Briefly, the main benefits of this technique are:

- The system is based on a chloride balance and all the chloride carried over from the rinse tank to the flux tank is utilised in the generation of zinc ammonium chloride make-up.
- Iron is removed.
- No waste water treatment is necessary.
- Promotion of the rinse water to the acid tanks allows a significant saving in acid costs.
- Water input and costs are minimised. [185, Choice et al. 1998]

Sourcing spare parts for the equipment was reported as a potential problem as the supplier is based in Australia. [146, EGGA 2000]

Iron removal using ion exchange columns

The ion exchange process uses resin to absorb the iron. As this process is sensitive to solid particles, the flux solution is filtered first. This can be done with a standard plate filter. By adding concentrated NaOH, the pH is set to the required pH value. The neutralisation unit is continuously stirred to create a homogeneous solution. The solution is then pumped through the ion exchange column where iron is absorbed by the resin. After leaving the column, the liquid is returned to the rinse/flux bath. When the resin is saturated with iron, it must be stripped and regenerated. The stripping/regeneration solution is pumped from a storage vessel through the column into another vessel. An exchange of iron and acid takes place in the column. Iron is dissolved in the HCl, while the acid is absorbed by the resin. [157, Sprang 1997]

Achieved environmental benefits

Reduction of waste (spent flux).

Environmental performance and operational data

Iron removal using ammonia and H₂O₂ oxidation

Example CM Jernvarer AIS

CM Jernvarer AIS has established a regeneration system for their fluxing bath enabling them to continuously remove iron from their bath. In the purifying process, the hydrochloric acid is neutralised, thus generating ammonium chloride which is one of the two components of the bath. The optimum composition of the fluxing bath is maintained by dosing extra zinc chloride and ammonium chloride calculated on the basis of routine chemical analyses. [150, Danish EPA 1993]

The system has been designed for continuous purification of the fluxing bath, and about 5 000 litres are purified daily. With this capacity, the system is actually capable of purifying a fluxing bath being contaminated by iron corresponding to a production of at least 10 000 tonnes of products per year. The bath is pumped through a reactor to which hydrogen peroxide and ammonia water are dosed by a redox and pH controller. The iron is oxidised and precipitated as iron hydroxide sludge. The sludge is collected in a sludge thickener and separated. The sludge is then dewatered in a filter press, the filtrate and decanting water from the thickener being collected in a storage tank from where it is reused in the fluxing bath. Discarded fluxing bath with a high iron content may also be purified by the system. It is either fed slowly together with the lightly polluted fluxing liquid from the fluxing tank or it may be purified separately by

several successive treatments. Discarded stripping acid may be treated too. In this case a reduced dose is required to avoid getting too high sludge concentrations in the liquid. The stripping acid contains great volumes of zinc chloride which are admixed to the fluxing bath in this process. However, since a certain ratio between ammonium chloride and zinc chloride has to be maintained in the fluxing bath, there is an upper limit to the volume of stripping acid that may be taken into the system if the zinc chloride concentration is to be kept at the optimum value. [150, Danish EPA 1993]

In the purification of old fluxing baths, no ammonium water was dosed because the pH value remained at the desired value of 4.5. Normally the consumption of ammonia is 2.4 g of 25 % ammonium water per g of iron II (dissolved iron). This corresponds to an expected consumption of 1 800 kg of ammonium water for the regeneration of fluxing baths of 50 m³. There were no major problems during the running-in period, and after some minor adjustments the system is today running as planned with minimum time spent on operation and maintenance. After purification of the old fluxing baths, the system is today linked to the fluxing bath used in the production so they are continuously keeping the iron concentration as low as possible. They have not yet started treating discarded stripping acid in the system. [150, Danish EPA 1993]

Example Galva 45

Results (January-April 1993) of the flux regeneration process in operation at Galva 45, France are shown below in Table 8.6:

Table 8.6: Operational data of the flux regeneration process at Galva 45 (France)

		First line (7m bath)	New automated line (3.5m bath)
Total salt content	(g/l)	461	450
ZnCl ₂ % - NH ₄ Cl%		55 - 45	57 - 43
Temperature	(°C)	46	50
Fe	(g/l)	0.9	0.38
ZnCl ₂ or NH ₄ Cl addition		0	NI
NB: NI = No information provided.			

Advantages in purifying fluxing baths

- Quality improvement: by maintaining acid and iron in the flux at very low levels (below 1 g/l), a sharp reduction in dross formation and, consequently, fewer coating defects due to dross inclusion in the zinc is observed. The zinc coating would have a more regular thickness and hence a shiny appearance. The reduction in the number of workpieces with surface defects would lead to a reduction in the workpieces having to be recycled.
- Reduction in zinc consumption: there would be reductions in zinc pick-up and of ash and dross formation, leading to valuable reductions in total zinc consumption.
- Increased internal profitability, thanks to the flux production and the reduction of effluent solution, which compensated for reagent costs and for iron solid residue disposal costs.
- Ecological process: there was a marked reduction in residue production since the tonnage of effluent solutions used to produce the flux was higher than the production of the new iron solid residue.

Iron removal using electrolytic oxidation

Example Industrial Galvanizers Corporation

The galvanising plant is processing 10 000–12 000 tonnes per year of general workpieces which includes a reasonable proportion of tube and manufactured products. The average steel section thickness processed by this plant is approximately 3 mm.

The three identifiable plant operating costs associated with iron contamination of flux are: effluent disposal, zinc usage cost and chemical usage cost. The costs will vary from plant to

plant and vary within a plant depending on the method used to control the composition of the preflux solution. In the case studied, a rinse system was used to avoid carry-over of acid and iron into the preflux solution.

An examination of the operating costs of the plant before and after introduction of regeneration has shown the following cost savings:

- effluent disposal 20.2 %;
- dross production 27.6 %;
- chemicals 10.5 %;
- ash production 39.0 %;
- zinc 10.4 %.

Advantages

- Eliminating the need for rinse overflow or rinse treatment.
- Minimising the sludge for disposal from conventional flux treatment.

Disadvantages

The system requires considerable operator input, and problems for sourcing spare parts (from Australia) have been reported. [\[146, EGGA 2000 \]](#)

Iron removal using ion exchange columns

Example Dutch plant

Advantages

- Decrease in zinc pick-up from 9.5 % to < 7 %.
- Higher production rate - increase of over 10 %.
- Lower production of zinc ash.
- Lower production of fume.
- Lower dross production from 8 t every 2 weeks to 2 t every 6 weeks.
- Higher quality product. [\[157, Sprang 1997 \]](#)

Cross-media effects

Generation of iron hydroxide sludge (60 % water, 6.5 % zinc, 20 % iron) requiring disposal in the case of iron removal using ammonia and H₂O₂ oxidation.

Technical considerations relevant to applicability

Applicability to existing batch galvanising plants may be restricted by a lack of space.

Economics

No information provided.

Driving force for implementation

Reduced costs due to increased material efficiency.

Example plants

CM Jernvarer A/S.

Reference literature

[\[146, EGGA 2000 \]](#), [\[149, Wedge Group 2000 \]](#), [\[150, Danish EPA 1993 \]](#), [\[185, Choice et al. 1998 \]](#).

8.6.3.4 Recovery of salts from the spent fluxing solution for production of fluxing agents

Description

Spent fluxing solution is used to recover the salts contained therein to produce fluxing agents. This may take place on or off site.

Technical description

The salts in the spent fluxing solution can be reused for fluxing agent production. This may take place on site or off site by fluxing agent producers. This technique is not used in hot dip coating of sheets where fluxing is not carried out.

Achieved environmental benefits

Reduced amount of waste sent for disposal.

Environmental performance and operational data

No information provided.

Cross-media effects

No information provided.

Technical considerations relevant to applicability

Applicability may be restricted depending on the availability of a market.

Economics

No information provided.

Driving force for implementation

Reduced costs due to increased material efficiency.

Example plants

Th. Goldschmidt, Germany.

Reference literature

No reference literature provided.

8.6.3.5 Minimisation of drag-out of fluxing solution

Description

The drag-out of the fluxing solution is minimised by allowing enough time for it to drip off.

Technical description

The drag-out of the fluxing solution is minimised by allowing enough time for it to drip off. This technique is not used in hot dip coating of sheets where fluxing is not carried out.

Achieved environmental benefits

Increased material efficiency.

Environmental performance and operational data

No information provided.

Cross-media effects

No information provided.

Technical considerations relevant to applicability

Generally, there are no technical restrictions to the applicability of this technique.

Economics

No information provided.

Driving force for implementation

No information provided.

Example plants

Widely used.

Reference literature

No reference literature provided.

8.6.4 Techniques to increase material efficiency in hot dipping**8.6.4.1 Reduction of the generation of bottom dross****Description**

The generation of bottom dross is reduced, e.g. by sufficient rinsing after pickling, removing the iron from the fluxing solution (see Section 8.6.3.3), using fluxing agents with a mild pickling effect and avoiding local overheating in the galvanising kettle.

Technical description

The following techniques reduce the generation of bottom dross:

- Sufficient rinsing following pickling.
- Continuous regeneration of the flux bath.
- Use of fluxing agents with a low ammonium chloride content which have a low pickling effect (removal of iron).
- Avoiding local overheating in the externally heated galvanising kettles (reaction with the boiler walls). [\[82, DE, TWG member 1999 \]](#), [\[146, EGGA 2000 \]](#)

This technique is not used in hot dip coating of sheets where fluxing is not carried out.

Achieved environmental benefits

Less waste, more efficient use of raw material (no need to recycle bottom dross).

Environmental performance and operational data

No information provided.

Cross-media effects

Rinsing generates waste water.

Technical considerations relevant to applicability

Generally, there are no technical restrictions to the applicability of this technique.

Economics

No information provided.

Driving force for implementation

Reduced costs due to increased material efficiency.

Example plants

Widely used.

Reference literature

[\[82, DE, TWG member 1999 \]](#), [\[146, EGGA 2000 \]](#).

8.6.4.2 Prevention, collection and reuse of zinc splashes in batch galvanising

Description

The generation of zinc splashes from the galvanising kettle is reduced by minimising carry-over of the fluxing solution. Zinc splashes out of the kettle are collected and reused. The area surrounding the kettle is kept clean to reduce contamination of the splashes.

Technical description

The following techniques reduce the generation of splashes:

- Sufficient drying after the flux bath.
- Area surrounding the galvanising kettle is kept clean to obtain recoverable zinc containing a minimum of impurities. [[82, DE, TWG member 1999](#)]

Achieved environmental benefits

Less waste, more efficient use of raw material (no need to recycle splashes for zinc recovery).

Environmental performance and operational data

No information provided.

Cross-media effects

Energy needed for drying the workpieces.

Technical considerations relevant to applicability

Generally, there are no technical restrictions to the applicability of this technique.

Economics

No information provided.

Driving force for implementation

Reduced costs due to increased material efficiency.

Example plants

Widely used.

Reference literature

[[82, DE, TWG member 1999](#)].

8.6.4.3 Reduction of the generation of zinc ash

Description

The formation of zinc ash, i.e. zinc oxidation on the bath surface, is reduced for example by:

- sufficient drying of the workpieces/wires before dipping;
- avoiding unnecessary disturbance of the bath during production, including during skimming;
- in continuous hot dipping of wires, reducing the bath surface that is in contact with air using a floating refractory cover, especially during standby.

Technical description

Zinc ash is a mixture comprising zinc metal, zinc oxide and zinc chloride that is formed on the surface of the molten zinc bath. To minimise the amounts of zinc ash forming on the bath surface, a number of simple measures can be put in place such as thoroughly drying the

workpieces and/or wires before hot dipping, maintaining steady bath operation (including during skimming) and using floating refractory covers in continuous hot dip coating of wires to minimise zinc oxidation with ambient air.

Achieved environmental benefits

Increased material efficiency.

Environmental performance and operational data

No information provided.

Cross-media effects

None reported.

Technical considerations relevant to applicability

Generally, there are no technical restrictions to the applicability of this technique.

Economics

No information provided.

Driving force for implementation

Reduced costs due to increased material efficiency.

Example plants

Widely used.

Reference literature

No reference literature provided.

8.6.5 Techniques to recover spent pickling acids

Description

Techniques to recover spent pickling acids on site or off site include:

- spray roasting or using fluidised bed reactors for the recovery of hydrochloric acid;
- crystallisation of ferric sulphate for the recovery of sulphuric acid;
- spray roasting, evaporation, ion exchange or diffusion dialysis, for the recovery of mixed acid;
- use of spent pickling acid as a secondary raw material (e.g. for the production of iron chloride or pigments).

Technical description

Crystallisation (H₂SO₄)

Sulphuric acid recovery by crystallisation is based on the decreasing solubility of iron sulphate with decreasing temperatures. By cooling spent pickling acid (e.g. to temperatures of 6–10 °C), iron sulphate heptahydrate (FeSO₄ • 7 H₂O) crystallises and is removed from the acid by sedimentation followed by centrifugation. The regenerated sulphuric acid is recycled back to the pickling tank while the iron sulphate can be sold. [[148, IT 18-4-17 2017](#)], [[160, BG Q 198 2018](#)]

With respect to the type of cooling, the following heptahydrate crystallisation processes for regeneration are available: crystallisation with indirect cooling, cyclone crystallisation and vacuum cooling crystallisation. The treatment of spent pickle solution by crystallisation avoids the need to neutralise free acid; furthermore the iron is precipitated as heptahydrate and does not have to be neutralised either. With crystallisation processes a significant enhancement of the waste water releases and a reduction of the salt load can be achieved. As an example, Figure 8.25 shows the vacuum cooling crystallisation process.

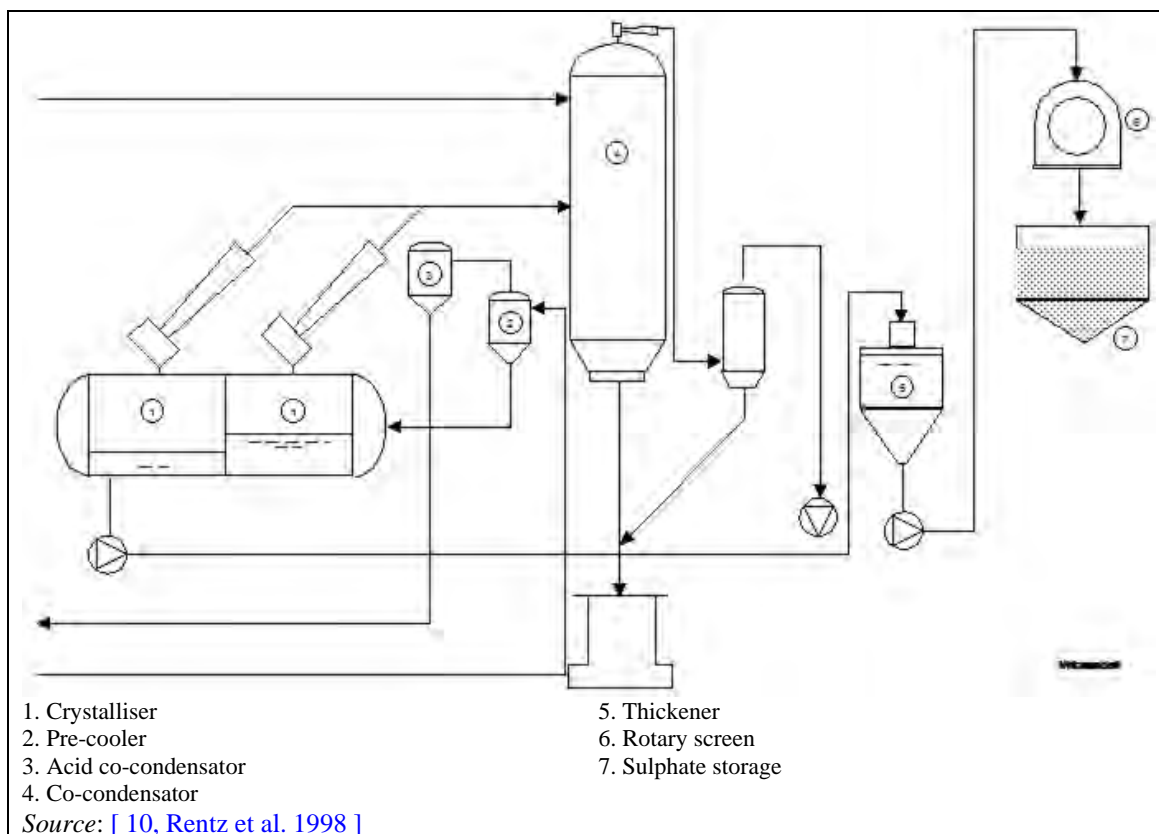


Figure 8.25: Vacuum cooling crystallisation process for H_2SO_4

Evaporative recovery (HCl)

The evaporative hydrochloric acid recovery system is a forced circulation flash evaporator with controlled two-stage condensation/separation. The spent acid solution is aggressively heated to extract the acid and water from the spent pickling acid. Only a concentrated ferrous chloride solution remains.

The spent acid solution is led to the recovery unit via a filter and a preheat exchanger, utilising the remaining heat of the acid and water vapours generated in the evaporative process (See Figure 8.26). The preheated spent acid solution then enters the evaporation section where it quickly loops through the main heat exchanger and into the separator vessel where water and acid vaporise. Acid and water vapour are continuously driven from the waste solution until the solution temperature reaches about 110 °C. At that temperature, the solution has reached saturation and is ready for removal from the evaporator. A PLC (programmable logic controller) automatically adjusts the rate of spent acid fed into the process and the volume of ferrous chloride concentrate removed from the loop and stored in a holding tank. [156, Cullivan 1997]

Forced by the expanding vapours in the separator, the acid and water vapours are driven through the feed exchanger and into the acid condenser. The condensing acid vapour combines with some of the condensing water vapour as it descends through the acid condenser. The concentration of the acid is controlled in this step to return the right quality to the pickling process. The remaining water vapour is led into the water condenser where it is cooled and scrubbed of any residual acid vapour. No vapours leave the system because the process cools any remaining vapour to a condensate. The final condensate can be reused, e.g. as rinse water in the pickling process.

An optional heating loop added to the acid condensing section can provide a precise pickling acid concentration. Since the recovered acid concentration typically ranges from 5 % to 15 %, this additional cost is usually not warranted. The recovered acid is strong enough for pickling and is combined with a more concentrated mix of HCl when fresh make up acid is added. [156, Cullivan 1997]

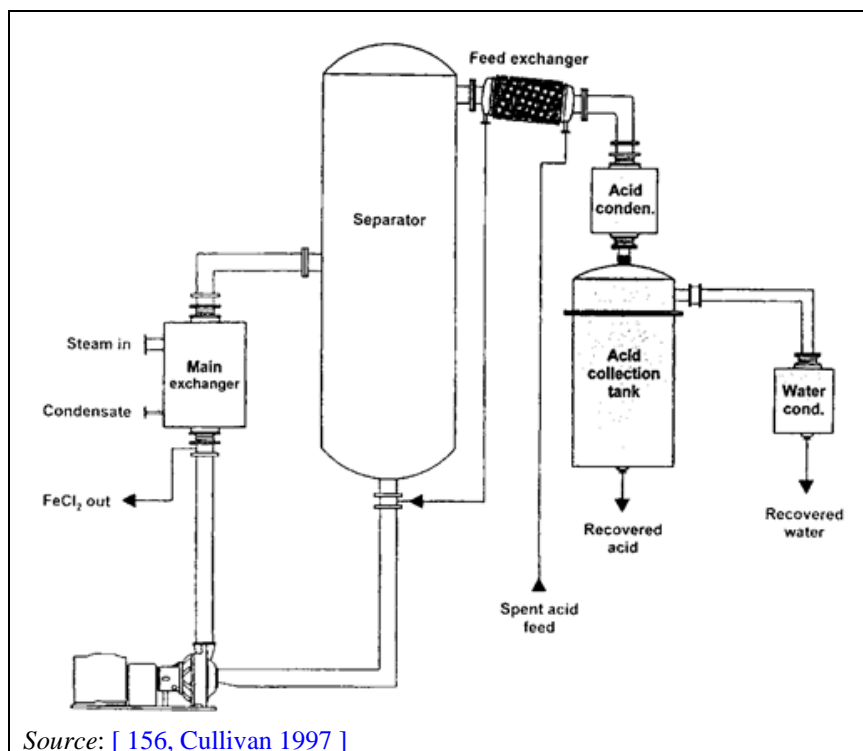


Figure 8.26: Evaporative acid recovery

The process is easy to operate. Since it has only a few moving parts and the acid vapours essentially clean the system while it operates, downtime for maintenance of heat exchangers and reactors has proven minimal. Normal maintenance includes changing filters, attending to pumps and checking the boiler and cooling tower loops to ensure optimum performance. [156, Cullivan 1997]

Acid retardation (HCl, H₂SO₄, HF/HNO₃)

The principle of the retardation process is based on the adsorption of free, undissociated acid to ion-exchange resins as the dissolved metals pass through the resin bed. In backwashing with water, the adsorbed acid is re-released because of the difference in osmotic pressure. Free-acid recovery rates are about 80–90 % for hydrochloric acid and sulphuric acid. The advantages of the process are that it requires little apparatus and space. The energy requirement for the regeneration process is confined to electrical energy. Electricity consumption varies between approximately 0.25 kWh/kg and 0.40 kWh/kg of iron depending on throughput. The requirement for demineralised water is approximately 1 m³/m³ of regenerated pickling solution. [71, Fichtner 1994], [82, DE, TWG member 1999]

The use of the retardation process is feasible when acid consumption is at least about 40 l/h. The average metal content in the pickling solution should not exceed 50–60 g/l. The resulting waste consists of a metallic salt solution which, depending upon composition, can be utilised. [71, Fichtner 1994], [82, DE, TWG member 1999]

Diffusion dialysis (HCl, H₂SO₄, HF/HNO₃)

Diffusion dialysis is a membrane separation process where an anion exchange membrane is placed between a rinse water stream (water side) and the flowing spent pickle liquor containing dissolved metals in solution (feed side). The anion exchange membrane exhibit a positive charge on its surface which attracts the negatively charged anions in solution. Hence, the chloride (or sulphate / nitrate / fluoride) ions which are negatively charged are flowing from the feed side to the water side (see Figure 8.27). The dissolved metals positively charged (e.g. Fe²⁺) present in the feed side will not be able to pass through the positively charged membrane and will remain in the feed side. However, the H⁺ ions despite being positively charged will flow

through the membrane together with the chloride ions because of their smaller size and higher mobility allowing electrical neutrality in the water side. [102, Luo et al. 2011]

The membranes are assembled in a membrane stack similar to a filter press with a usual specific capacity of 0.5–2 l/hm². The demineralised water and the used acid are led in countercurrent through the cells in an alternating manner. The demineralised water adopts the free acid and the resulting diffusate is recycled to the pickling process. The other part-stream - dialysate - is mostly led to the neutralisation. In certain cases this part stream can also be recycled or retreated. [100, Deutschle 1993]

The process of diffusion dialysis has been used successfully for recovery of H₂SO₄, HCl, HNO₃ and HF. It is possible to extract 80–85 % of free acids from used pickling solutions and to recycle it in a purified form with about 5 % metal pollution. [100, Deutschle 1993]

The membrane lifetime is normally 3–5 years, but it can be reduced by oxidising substances such as hydrogen peroxide, chromic acid, nitric acid with concentrations of over 20 % as well as temperatures over 45 °C and organic substances such as tensides, oils, grease, solvents or cleaners. In most cases in which organic substances cause membrane fouling, a pretreatment of the raw solution with activated carbon does help. [100, Deutschle 1993]

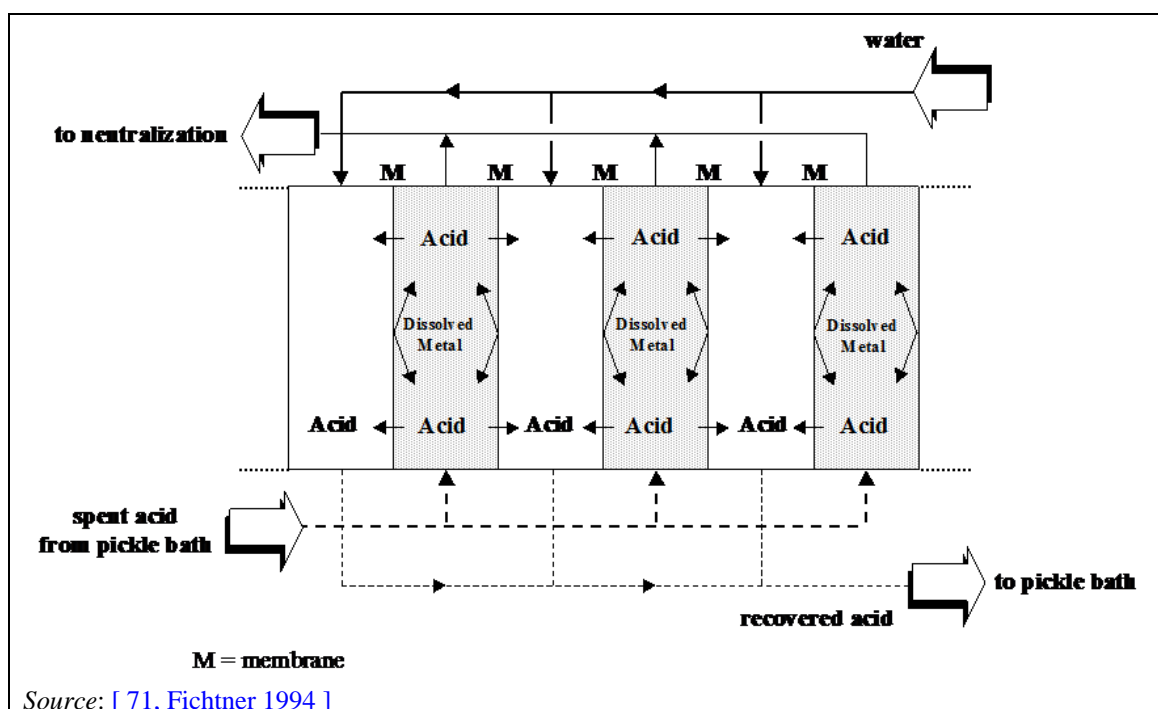


Figure 8.27: Principle of diffusion dialysis

The advantages of the process are that it requires little equipment and space and has low operating costs. The energy requirement for diffusion dialysis is confined to electricity to run the pumps. Electricity consumption per kg of removed iron varies between 0.1 kWh and 0.23 kWh. The requirement for demineralised rinse water is approximately 1 m³/m³ regenerated pickling solution. Diffusion dialysis can be used when acid consumption is at least about 60 l/h. The average metal content in the pickling solution should not exceed 50–60 g/l. [71, Fichtner 1994], [82, DE, TWG member 1999]

Further reported advantages of the process:

- Small energy requirement.
- Considerable reduction of fresh acid requirement, of neutralisation and deposition costs.
- Very low maintenance costs.
- Long membrane life.
- Short amortisation time. [100, Deutschle 1993]

Pyrohydrolysis: Fluidised bed process (HCl)

The basis of the process is the thermal decomposition of spent pickle liquor, which is converted at high temperature in the presence of water vapour and oxygen into hydrochloric acid and iron oxide:

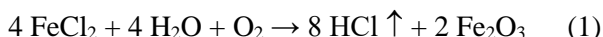


Figure 8.28 shows the main subprocesses of the fluidised bed acid regeneration process. The spent pickle liquor is pumped into a separating vessel and then concentrated in a Venturi loop by hot gases from the reactor. A share of the concentrated pickle from this loop is continuously fed into the fluidised bed of the reactor. Within the fluidised bed, which consists of iron oxide granulate, acid and water are evaporated at a temperature of about 850 °C and iron chloride is converted into iron oxide and hydrochloric gas according to equation (1).

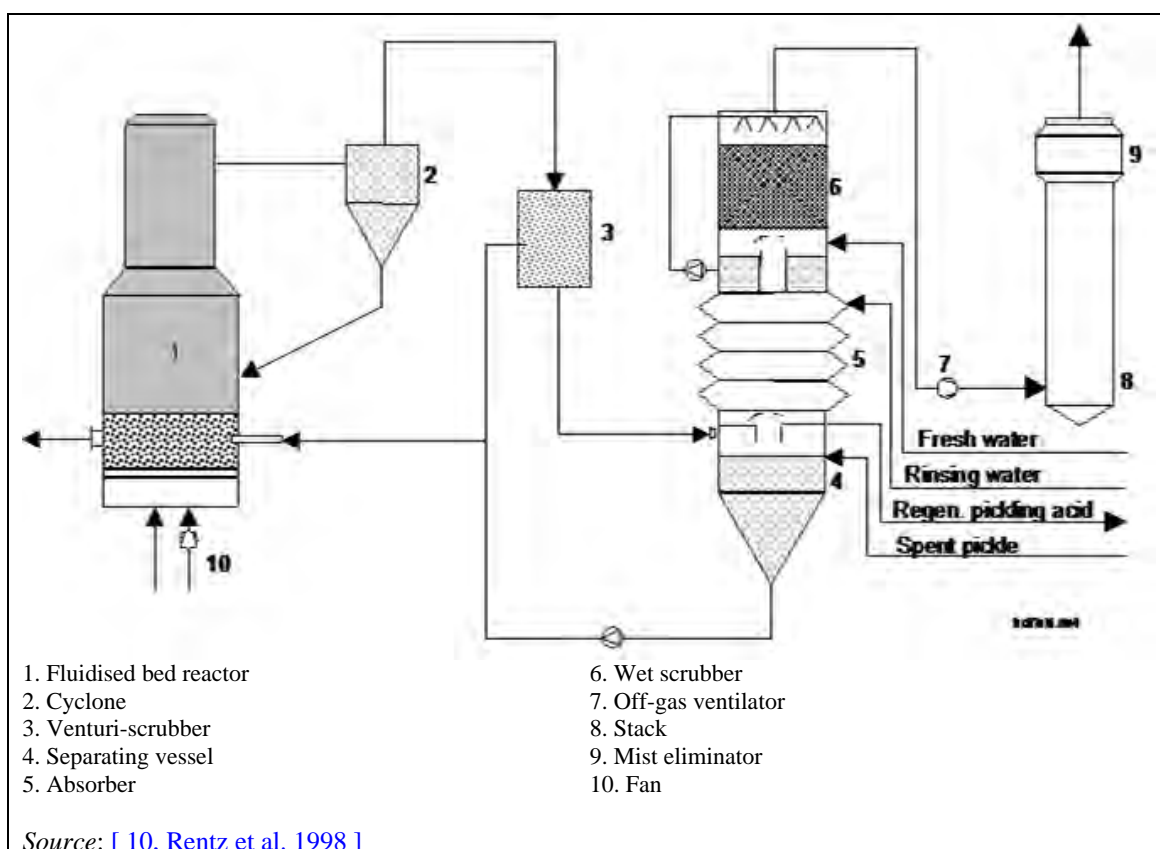


Figure 8.28: Fluidised bed HCl acid regeneration process

Growth and new formation of iron oxide grains in the fluidised bed are controlled so that a dust-free granulated product is obtained with a grain size of 1–2 mm and a bulk density of about 3.5 t/m³. The granular product is discharged continuously from the bottom of the reactor, and transported by a vibrating cooling chute and vibrating spiral conveyor to the oxide storage bin.

The hot off-gas from the reactor contains hydrochloric gas, overheated steam, combustion products and small amounts of iron oxide dust, which is separated from the gas in a cyclone and recycled to the fluidised bed. The off-gas is then cooled to a temperature of about 100 °C in the Venturi scrubber. The thermal energy of the hot off-gases is used to concentrate the spent pickling liquor by evaporation before it is fed to the reactor. Very fine dust particles in the gas stream are removed by scrubbing.

From the venturi scrubber, the cooled gas stream goes to the absorber, where hydrogen chloride is absorbed adiabatically with rinse liquor from the pickling line and fresh water. The hydrochloric acid thus produced has a concentration of approximately 18 wt-%. It is recycled to

The hydrochloric gas, steam and combustion gases are ducted via the pre-vaporiser to an absorber. The resulting off-gas is subsequently cleaned by alkaline washing and is released via a stack into the atmosphere.

The gases containing HCl are absorbed in an adiabatic column where rinse water from the pickling line can be used as absorption water. The generated hydrochloric acid (about 18 %) can be returned to the pickling process. The off-gas from the absorption unit is subsequently cleaned in a caustic scrubber with the addition of sodium thiosulphate, which results in pollutant concentrations of less than 2 mg/m^3 of HCl and free Cl_2 .

Because of the application of the iron oxide by-product in the ferrite industry, higher quality demands on the oxide have arisen in recent years. Besides physical parameters such as specific surface area, primary particle size and tap density, which are important for the solid state reactions of the iron oxide with manganese, nickel and zinc oxide, the impurity level of the oxide is critical. Therefore a preprocessing process was developed to produce ultra-pure iron oxide with especially low contents of silicon, phosphorous and heavy metals such as chromium, nickel or copper. The process flow sheet is shown in Figure 8.30, presenting the following process steps:

- Reduction of free acid and cementation of heavy metals by scrap.
- Increase of pH by ammonia addition.
- Partial oxidation of Fe^{2+} to Fe^{3+} leading to specific adsorption of Si and P to ferric and aluminium hydroxide.
- Filtration to remove hydroxide sludge.

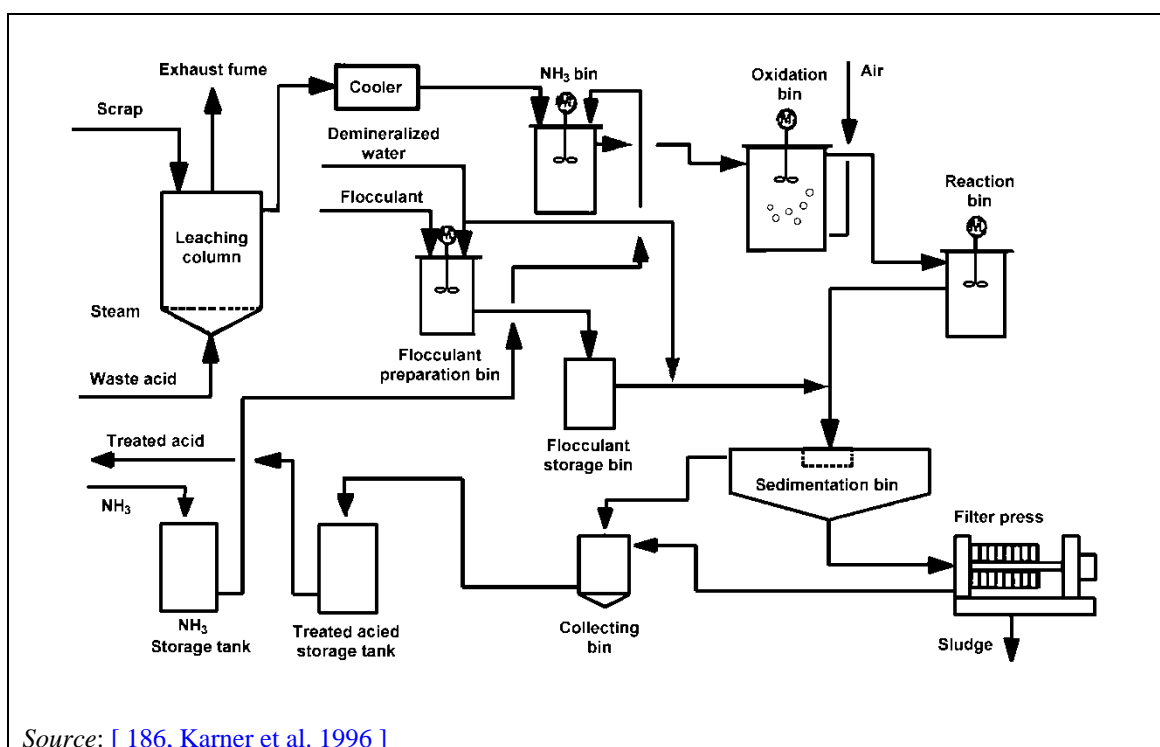
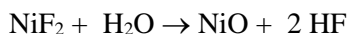
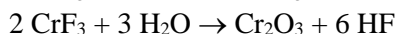
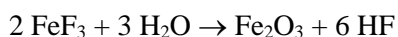


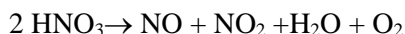
Figure 8.30: Process flowsheet for the production of high-purity oxides

The spray roasting process for the regeneration of **mixed acids** from stainless steel pickling is quite similar to the one for hydrochloric acid, but it also includes an isothermal absorption step and a tail-gas cleaning system using a catalytic converter for NO_x . The spent pickle liquor containing the fluoride complexes of iron, chromium, nickel and minor metals as well as free hydrofluoric and nitric acid is first led to a pre-evaporiser, where it is partly evaporated by the

contact with hot gases from the reactor. The pre-concentrated pickle liquor is fed into the reactor via nozzles. Inside the reactor, the following decomposition reactions are taking place:



In addition, nitric acid is partly decomposed into nitrogen oxides:



The reactor is directly heated with burners using natural or other gases. The mixed metal oxide is collected at the bottom of the reactor. The oxide is kept at 500 °C to 600 °C at the flat bottom of the reactor to reduce the fluoride content below 1.5 %. This oxide is usually pelletised and can be recycled in an electric arc furnace. [98, Karner 1999], [186, Karner et al. 1996]

The reactor off-gases, which contain water vapour, combustion gases, HF, HNO₃ and NO_x are led to a two-stage absorption unit, where cooled recirculated acid is used for absorption. Hydrogen peroxide is added to the second column in order to oxidise NO to NO₂, which can be absorbed more easily. Contrary to the hydrochloric acid regeneration, the absorption is carried out isothermally, i.e. the liquid in the two columns is recycled and cooled in external heat exchangers. In the columns, regenerated acid is produced which contains free and bound hydrofluoric acid and up to 85 % of the nitric acid. The regenerated acid is reused in the pickling process. [98, Karner 1999], [186, Karner et al. 1996]

The off-gas after the absorption columns is first cleaned in an (alkaline) wet scrubber to remove traces of HF and the tail gases, which contain NO_x from nitric acid, are cleaned by a selective catalytic reduction using NH₃ or urea or ammonium compounds as a reducing agent. The NO_x is thus converted to harmless nitrogen and water. Figure 8.31 shows the flowsheet of a spray roasting process for mixed acids (Pyromars process). [98, Karner 1999], [186, Karner et al. 1996]

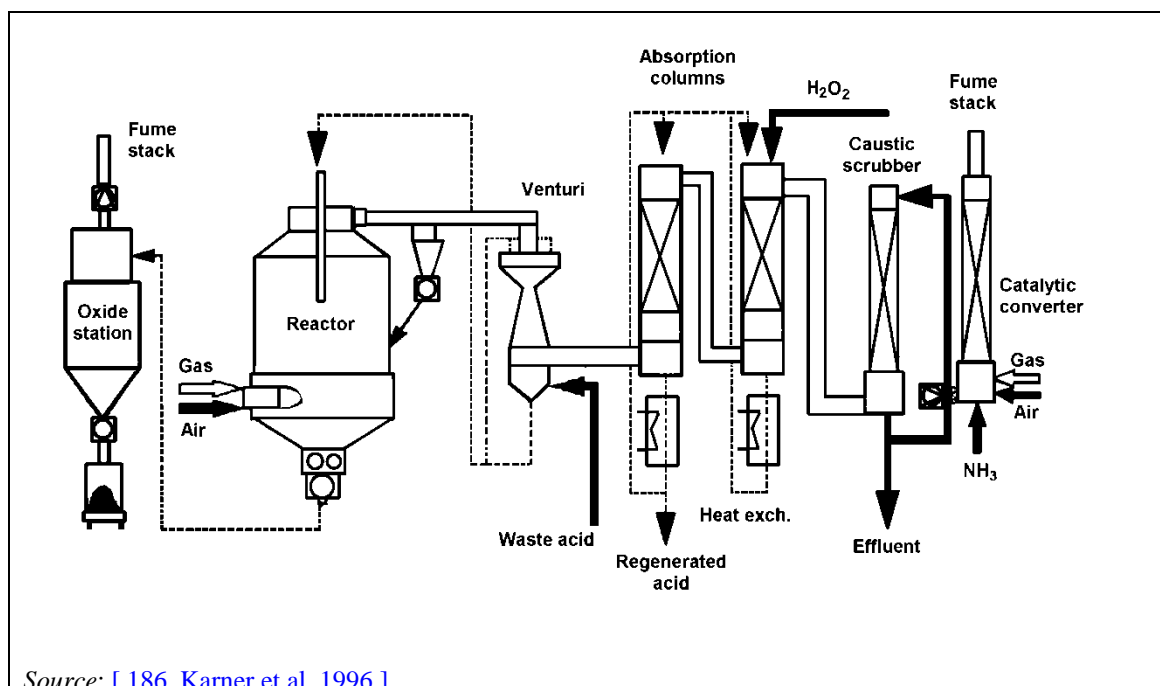


Figure 8.31: Spray roasting mixed acid regeneration process

Electrolytic regeneration (HCl, H₂SO₄)

The electrolytic regeneration of acid is based on iron precipitation at the cathode of the electrolytic cell and water splitting and acid reformation at the anode.

For HCl, a recovery of free and iron-bound acid is possible but, simultaneously with the water splitting at the anode, chloride gas is formed. This requires a waste gas extraction and waste gas cleaning unit.

In regenerating H₂SO₄, an additional electrolyte (ammonia sulphate) is used and cathode and anode are separated by an ion exchange membrane. Iron is precipitated on cathodic stainless steel plates while sulphate ions in the anodic part reform H₂SO₄ which can be recycled to the pickling operation.

Bipolar membrane (HF/HNO₃)

Acid regeneration using bipolar membranes comprises a combination of processing steps. First, the free acid is recovered, e.g. by diffusion dialysis. Then the remaining spent acid solution is neutralised with potassium hydroxide (KOH), thus generating metal hydroxides and salts such as potassium chloride (KCl) or -with mixed acids- potassium fluoride (KF). The metal hydroxides are precipitated as sludge and further processed, e.g. dewatered. By thoroughly washing the metal hydroxide sludge, virtually all chloride and fluoride is transferred into solution. The KCl/KF-containing salt solution is then further concentrated by electrodialysis. The generated water can be used for metal hydroxide sludge washing. [[71, Fichtner 1994](#)]

The bipolar membrane process is an electrically driven membrane process similar to electrodialysis in that it employs ion exchange membranes to selectively separate charged ions in solution, but distinguished by the water splitting characteristics of a bipolar membrane. [[81, Haskoning 1993](#)]

The membranes are composed of two distinct layers of oppositely charged ion exchange materials. Subjected to an electrical current, the cations in the salt solution (potassium) pass through the cation exchange membrane into a parallel water flow (See Figure 8.32); the anions (chloride, fluoride) pass through the anion exchange membrane into another parallel water flow. Due to the bipolar membrane, the water is continuously dissociated (split) into H⁺ and OH⁻. With the anions and cations of the salt solution, acid and base, in this case KOH, are generated. The acid is recycled to the pickling process; the KOH is recycled to the neutralisation step. [[71, Fichtner 1994](#)]

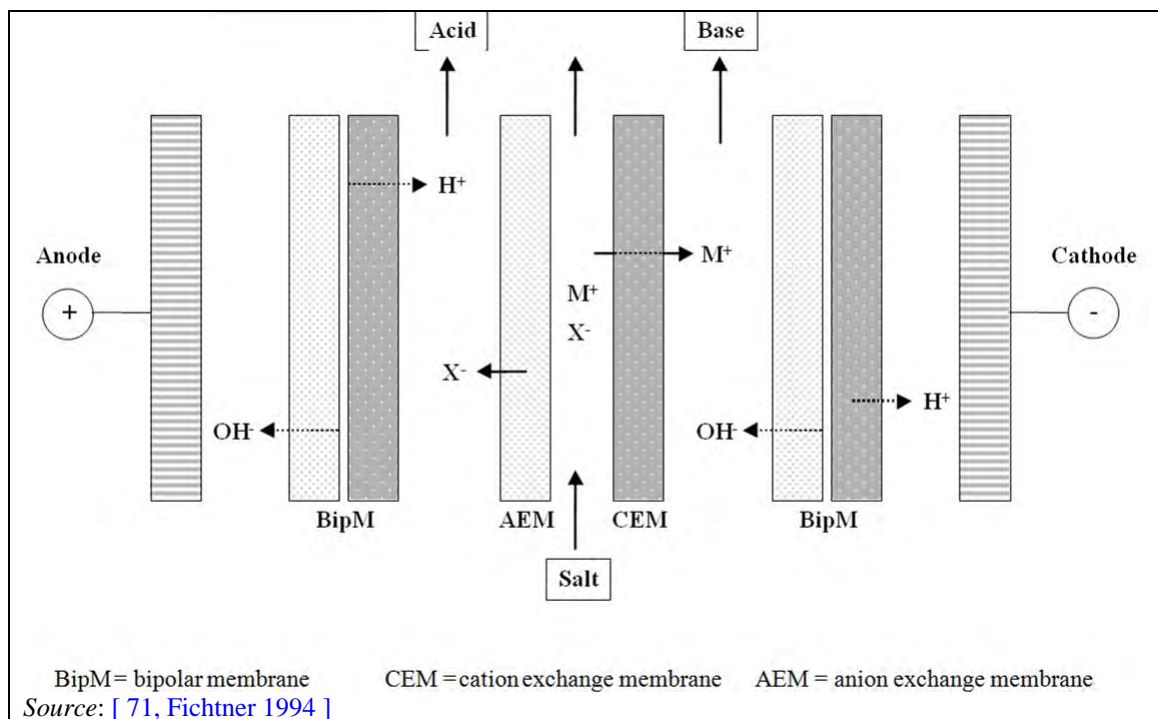
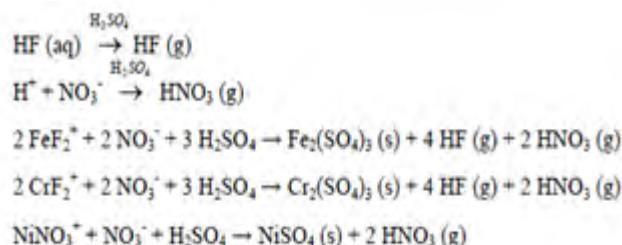


Figure 8.32: Principle of salt splitting by bipolar membranes

Evaporation process (HF/HNO₃)

The spent pickling acid is fed to a vacuum evaporator together with circulating sulphuric acid. In the vacuum evaporator the mixed acid is heated at about 90 °C. Make-up sulphur acid is added to such an extent that a concentration of at least 60 % is reached. This concentration ensures a high yield of recovered pickling acids. Metal fluorides and nitrates forms metal sulphates while the acid is liberated. These reaction products are formed according to the following reactions:



In the evaporation process, the following steps are taking place. First, the combustion gases generated in the vacuum evaporator are ducted down below the acid liquor surface through a dip tube. At this point, a sulphuric acid concentration of 80 % is reached at 150 °C. The underflow of the submerged combustion evaporator is led to the crystalliser tank. The combustion gases are washed in two steps to recover HF and HNO₃ acids from the gas. First, the gas is washed using a venturi scrubber. In addition, a general gas scrubber is included in the regeneration process. Gases from the venturi scrubber, from crystallisation and from other process steps are treated together. The acid solution washed from the gases is combined with the product acid from the evaporation and condensing part of the process. [25, EUROFER 2018]

Long enough residence time in the evaporation-crystallisation circuit improves the filtering properties of the sulphate salt formed. The sulphate slurry from the crystalliser tank is pumped to a cone thickener. The underflow of the thickener is led to a press filter to separate the metal sulphates from the acid liquor. The filtrate is returned to the crystalliser. The metal sulphate

cake from the press filter is neutralised in a separate process to form metal hydroxides. [25, EUROFER 2018]

In the evaporation process, high-quality materials including special corrosion-resistant steels and fluorocarbon polymers are extensively used as construction materials for the process equipment. [25, EUROFER 2018]

The evaporation process is also applicable to three-acid pickling (HF , HNO_3 and H_2SO_4) – (See Section 3.4.1.13). [25, EUROFER 2018]

A flowsheet of the evaporation process for mixed acid recovery is shown in Figure 8.33.

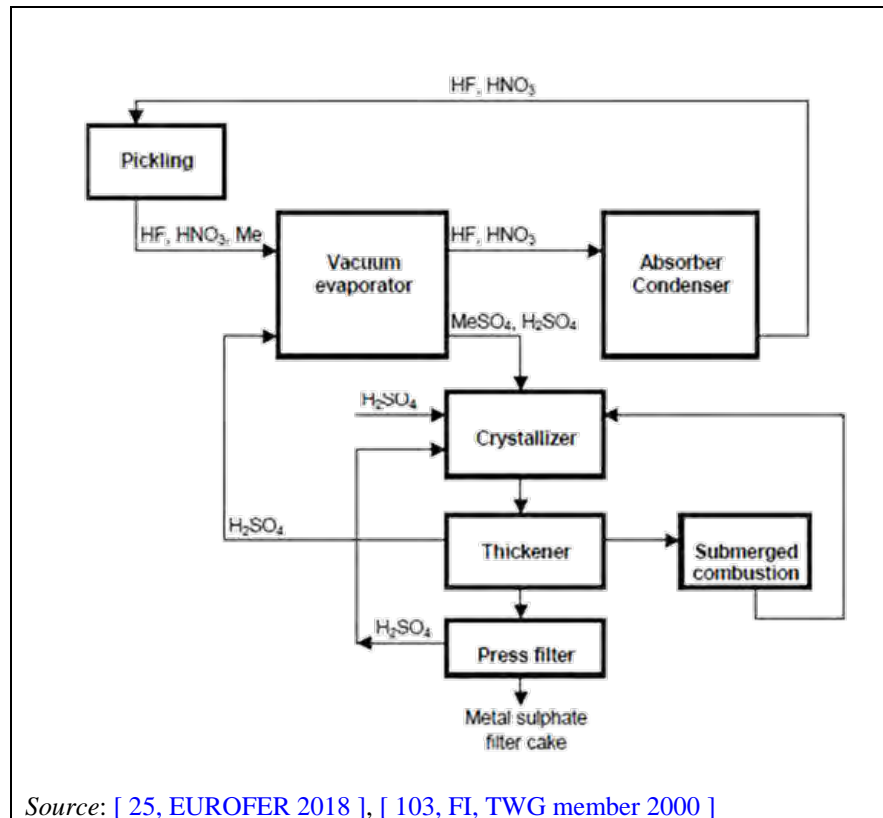


Figure 8.33: Evaporation process for mixed acid regeneration

Achieved environmental benefits

- Increased material efficiency.
- Reduction of pickling acid sent for disposal.

Environmental performance and operational data

Table 8.7 gives an overview of the available acid regeneration and acid reclamation techniques.

Table 8.7: Overview of regeneration and reclamation processes

Processes for recovery and regeneration of spent acids from HCl pickling plants							
	Pyrohydrolysis	Retardation	Dialysis	Electrolytic oxidation	Electrolytic Fe-precipitation	Chemical oxidation	Ion exchange
1. Principle of process.	Regeneration	Recovery of free HCl	Recovery of free HCl	Transformation of FeCl ₂ to FeCl ₃	Regeneration of HCl Electrolysis	Transformation of FeCl ₂ to FeCl ₃	Recovery of free HCl acid
2. Other products	Iron-oxides	-	-	FeCl ₃	Ferrous shots	FeCl ₃	FeCl ₃
2.1 Waste for disposal	-	Acidic FeCl ₂ solution	Acidic FeCl ₂ solution	-	-	-	
3. Regeneration rate total acid	> 99 %	For neutralisation	For neutralisation	> 95 %	> 95 %	> 95 %	
3.1 free acid		75 - 90 %	75 - 90 %				50 - 70 %
4. Input for regeneration	- Electrical energy - Natural gas - Fresh- and waste-water	- Electrical energy - VE-water	- Electrical energy - VE-water	- Electrical energy - muriatic acid	- Electrical energy	- Electrical energy - HCl + air or Cl ₂ or HCl + H ₂ O ₂	- Electrical energy - VE-water - Oxidation agents as for chemical oxidation
5. Field of application l/h	> 300	> 40	> 60	> 20	> 20	> 20	> 40
6. Complexity of installation	High	Low	Medium	Low	Medium	Medium	High
7. Required space	Big	Small	Medium	Small	Small	Medium	Medium
8. Benefit / cost ratio	High	Medium	Medium	Medium	Medium	Low	Low
9. Number of plants¹	ca. 250	ca. 15	ca. 5	2	???	???	1
Processes for recovery and regeneration of spent acids from H ₂ SO ₄ pickling plants							
	Crystallisation (indirect cyclone- or vacuum-cooling)	Retardation	Dialysis	Electrolytic oxidation	Process with HCl and pyrolysis	Crystallisation and roasting	Precipitation with solvents
1. Principle of process	Recovery of free H ₂ SO ₄	Recovery of free H ₂ SO ₄	Recovery of free H ₂ SO ₄	Regeneration	Regeneration	Regeneration	Recovery of free H ₂ SO ₄
2. Other products	FeSO ₄ ·7H ₂ O	-	-	Ferrous shots	Iron-oxide	Iron-oxide	Iron-oxide
2.1 Waste for disposal	(If Cr, Ni, Zn present)	Acidic FeSO ₄ for neutralisation	Acidic FeSO ₄ for neutralisation	-	-	-	(If Cr, Ni, Zn present)
3. Regeneration rate total acid				> 99 %	> 95 %	> 95 %	
3.1 free acid	> 99 %	80 - 90 %	75 - 85 %				> 99 %
4. Input for regeneration	- Electrical energy - Steam - Cooling water	- Electrical energy - VE-water	- Electrical energy - VE-water	- Electrical energy - Additional electrolyte in loop	- Electrical energy - Natural gas - Cooling water - HCl in loop by fresh- and rinsing water	- Electrical energy - Steam - Natural gas - Cooling water - Fresh and waste water	- Electrical energy - Steam - Cooling water - Solvent in loops
5. Field of application l/h	> 200	> 40	> 60	> 20	> 500	> 500	> 200
6. Complexity of installation	Medium/ high	Low	Medium	Medium	High	High	High
7. Required space	Medium/ big	Small	Medium	Medium	Big	Big	Medium
8. Benefit / cost ratio	Medium	Medium	Medium	Medium	Low	Low	Low
9. Number of plants¹	ca. 80	ca. 30	ca. 5	2	1	1	n.a.

Processes for recovery and regeneration of spent acids from HNO ₃ / HF pickling plants								
	Solvent extraction	Retardation	Dialysis	Crystallisation	Pyrohydrolysis	Bipolar membranes	Outokumpu process ²	Kawasaki process
1. Principle of process	Total regeneration	Regeneration of free acids	Regeneration of free acids	Regeneration of free acids	Total regeneration	Total regeneration	Total regeneration	Total regeneration
2. Regenerate / reg. acid	Total HNO ₃ and HF	Free HNO ₃ and HF	Free HNO ₃ and HF	Free HNO ₃ and HF	Total HNO ₃ and HF	Total HNO ₃ and HF	Total HNO ₃ and HF	Total HNO ₃ and HF
3. Other products	-			Metal fluorides	Metal oxide	Metal hydroxides	Ni(OH) ₂	Iron oxide
3.1 Waste for disposal	Metallic salt solution	Metallic salt solution	Metallic salt solution				Metal hydroxides	Metallic salt solution
4. Regeneration rate total acid	HNO ₃ 80 - 95 % HF 50 - 65 %				HNO ₃ 80 - 90 % HF 90 - 99 %	HNO ₃ 90 - 95 % HF 90 - 97 %	HNO ₃ > 97 % HF 99 %	HNO ₃ 75 - 90 % HF 85 - 95 %
4.1 free acids		HNO ₃ 80 - 95 % HF 80 - 90 %	HNO ₃ 85 - 95 % HF 80 - 90 %	HNO ₃ 80 - 95 % HF 50 - 55 %				
5. Input for regeneration	- Electrical energy - H ₂ SO ₄ - Cooling water - TBP in loop - Activated carbon	- Electrical energy - VE-water	- Electrical energy - VE-water	- Electrical energy - Cooling water	- Electrical energy - Natural gas - Cooling water - Fresh- and waste water - H ₂ O ₂ or similar	- Electrical energy - Caustic potash solution in loop - Diatom earth	- Electrical energy - H ₂ SO ₄ in loop- - Propane - Limestone - Steam - Cooling water	- Electrical energy - Extraction agents TBP and D2EHPA in loop - NH ₄ HF ₂ in loop - Natural gas, - Freshwater
6. Field of application l/h	>300	>40	>60	>300	>500	>100	4500	>1000
7. Complexity of installation	Medium	Low	Medium	Medium	High	High	Medium	Very high
8. Required space	Medium	Small	Medium	Medium	Large	Medium	Medium	Very large
9. Benefit / cost ratio	Medium	Medium	Medium	Low	Medium	Medium	Medium	Medium
10. Number of plants¹	2	ca. 30	ca. 5	1	2	2	2	1

Source of data in the Table: [10, Rentz et al. 1998]

¹ Worldwide, as at 1990, production and pilot plants

² Source of data [103, FI, TWG member 2000]

Technical considerations relevant to applicability

In batch galvanising, if the use of spent pickling acid as a secondary raw material is restricted by market unavailability, neutralisation of spent pickling acid may exceptionally take place.

The fluidised bed and spray roasting processes for HCl recovery are useful only for liquors which contain iron but no zinc. If zinc enters the feedstock there is a strong possibility of process upset.

Driving force for implementation

Reduced costs due to increased material efficiency.

Reference literature

[\[10, Rentz et al. 1998 \]](#), [\[25, EUROFER 2018 \]](#), [\[71, Fichtner 1994 \]](#), [\[81, Haskoning 1993 \]](#) [\[97, Rituper 1995 \]](#), [\[98, Karner 1999 \]](#), [\[100, Deutschle 1993 \]](#), [\[102, Luo et al. 2011 \]](#), [\[148, IT 18-4-17 2017 \]](#), [\[156, Cullivan 1997 \]](#), [\[160, BG Q 198 2018 \]](#) [\[186, Karner et al. 1996 \]](#).

More information on the techniques

More information on the techniques presented above, namely about environmental performance and operational data, cross-media effects, economics and example plants, is available in the sector-specific Sections 3.4.1.3, 3.4.1.4, 3.4.1.6 to 3.4.1.10, and 6.4.2.2.

8.7 Water use and waste water generation

8.7.1 Water management plan and water audits

Description

A water management plan and water audits are part of the environmental management system (EMS) and include:

- flow diagrams and a water mass balance of the plant;
- establishment of water efficiency objectives;
- implementation of water optimisation techniques (e.g. control of water usage, recycling, detection and repair of leaks).

Water audits are carried out at least once every year to ensure that the objectives of the water management plan are met. The water management plan and the water audits may be integrated in the overall water management plan of a larger installation (e.g. for iron and steel production).

Technical description

Some water optimisation techniques to consider are as follows:

a) Controlling water consumption

A prerequisite of any programme to prevent unnecessary use of water is to firstly collect information on the installation and the volumes consumed in the various processes, as part of the collection of information on types, quantities, composition and sources of all waste streams.

As with water consumption, data at site level is already a good benchmark in determining whether water consumption is excessive and is a good baseline against which to measure improvements. In order to allow a process-specific analysis, water use is monitored and recorded at machine/process level and water meters are regularly maintained and calibrated.

b) Reducing water consumption

By improved working practises

Production procedures are established and the personnel trained, in order to avoid inappropriate working practices and the absence of automated control systems that can lead to significant wastage of water, e.g. from overfilling which may occur during filling and rinsing.

By technical modifications

- Installation of magnetic drive pumps are employed instead of mechanical pumps to reduce water consumption and prevent leakages of fluids (See Section 3.4.1.11).
- Installation of reverse cascade rinsing systems (See Section 8.7.5).

By optimising water supply and treatment system

Semi-closed and closed loop water circuits are installed to reuse the process and cooling water after treatment and to minimise water consumption (See Sections 2.2.17 and 2.4.11.1)

By improving water treatment before reuse

Waste water containing scale and oil-bearing is treated separately using a sequence of cleaning steps (e.g. scale pits, settling tanks, cyclones, filtration) to separate oil and scale before reuse (e.g. See Section 2.4.11.2)

By reuse and/or recycling of water

- Water streams (e.g. process water, effluents from wet scrubbing or quench baths) are reused and/or recycled in closed or semi-closed circuits (see Sections 2.2.17 and 2.4.11.1), if necessary after treatment (see Section 8.9).
- Water from rinsing after pickling or degreasing is recycled to the preceding process baths as make-up water (See Section 8.7.6).

By operating water cooling systems in closed loops

The cooling water is recooled in cooling towers, heat exchangers or hybrid cooling towers (See Section 8.7.7).

Achieved environmental benefits

Reduction in water consumed and waste water discharged.

Environmental performance and operational data information

No information provided.

Cross-media effects

None.

Technical considerations relevant to applicability

The level of detail of the water management plan and water audits will generally be related to the nature, scale and complexity of the plant.

Economics

- Staff time.
- Cost of any additional metering required.

Driving force for implementation

Cost reduction depending on pricing of water and availability.

Example plants

Widely used.

Reference literature

No reference literature provided.

8.7.2 Segregation of water streams

Description

Each water stream (e.g. surface run-off water, process water, alkaline or acidic waste water, spent degreasing solution) is collected separately, based on the pollutant content and on the required treatment techniques. Waste water streams that can be recycled without treatment are segregated from waste water streams that require treatment.

Technical description

A detailed technical description of a waste water collection and segregation system can be found in the CWW BREF. [[168, COM 2016](#)]

Achieved environmental benefits

Reduction in water consumed and waste water discharged.

Environmental performance and operational data information

Separate discharge is recommended to avoid a dilution effect of the treated waste water. The more concentrated the effluents that result from separation are, the more generally effective their downstream treatment is.

Cross-media effects

None.

Technical considerations relevant to applicability

Applicability to existing plants may be limited by the layout of the water collection system.

Economics

Retrofitting costs associated with the separation/segregation of waste waters can be significant at existing plants. Waste water separation/segregation systems can be installed efficiently at new plants. Savings may be made from the reduction in the water holding capacity needed on the site.

Driving force for implementation

Cost reduction depending on pricing of water and availability.

Example plants

Widely used.

Reference literature

[168, COM 2016].

8.7.3 Minimisation of hydrocarbon contamination of process water

Description

The contamination of process water by oil and lubricant losses is minimised by using techniques such as:

- oil-tight bearings and bearing seals for working rolls;
- leakage indicators;
- regular inspections and preventive maintenance of pump seals, piping and working rolls.

Technical description

Reduction of oil and lubricant losses is a preventive measure against the contamination of process waters and the included scale. The use of modern design bearings and bearing seals for work-up and back-up rolls and the installation of leakage indicators in the lubricant lines (pressure monitoring equipment, e.g. at hydrostatic bearings) can reduce the hydrocarbon content (oil) of scale and waste water and reduces the oil consumption by 50–70 %. [4, EUROFER 1998]. In addition, preventive periodic checks and maintenance of seals, gaskets, pumps and piping reduce the chance of equipment failures and oil leakages.

Contaminated drainage water at the various consumers (hydraulic aggregates) is collected and pumped into intermediate storage tanks. The waste oil, after separation from water, can be used as a reducing agent in the blast furnace or can be recycled off site. The separated water may be further processed either in the water treatment plant or in dressing plants with ultrafiltration or a vacuum evaporator. [14, Hot Rolling Shadow Group 2000]

Complete prevention of water and scale contamination by hydrocarbons (oils and grease) is, even by applying precautionary measures, almost impossible.

Achieved environmental benefits

- Prevention of oil (hydrocarbon) contamination of water and scale.
- Reduced amount of oily scale.
- Reduction of water consumption.
- Reduction of the volume of waste water generated.

Environmental performance and operational data

No information provided.

Cross-media effects

None.

Technical considerations relevant to applicability

Generally, there are no technical restrictions to the applicability of this technique.

Economics

No information provided.

Driving force for implementation

Optimisation of water consumption.

Example plants

Widely used.

Reference literature

[\[4, EUROFER 1998 \]](#), [\[14, Hot Rolling Shadow Group 2000 \]](#).

8.7.4 Reuse and/or recycling of water

Description

Water streams (e.g. process water, effluents from wet scrubbing or quench baths) are reused and/or recycled in closed or semi-closed circuits, if necessary after treatment (see Section 8.9).

Technical description

In order to reduce costs, plants will strive to reuse and/or recycle water as much as possible. Hence, water streams (e.g. process water, effluents from wet scrubbing or quench baths) are reused and/or recycled in closed or semi-closed circuits (see Sections 2.2.17 and 2.4.11.1), if necessary after treatment (see Section 8.9). However, the recycling of certain water streams may only be partially possible. For example, to reduce waste water generation, quenching water is often used to prepare and refresh pickling acids. However, this could add large amounts of zinc to the acid which would hamper its recovery. [\[144, ABAG 1993 \]](#)

Achieved environmental benefits

- Reduction of water consumption.
- Reduction of the volume of waste water generated.

Environmental performance and operational data

No information provided.

Cross-media effects

None.

Technical considerations relevant to applicability

The degree of water reuse and/or recycling is limited by the water balance of the plant, the content of impurities and/or the characteristics of the water streams.

Economics

No information provided.

Driving force for implementation

Reduced costs due to reduced water consumption and reduced waste water generation.

Example plants

The use of closed and semi-closed process water circuits has been reported in various hot rolling, cold rolling, wire drawing and hot dip coating plants. [\[16, FMP TWG 2018 \]](#)

Reference literature

[\[144, ABAG 1993 \]](#).

8.7.5 Reverse cascade rinsing

Description

Rinsing is carried out in two or more baths in series where the feedstock is moved from the most contaminated rinsing bath to the cleanest.

Technical description

A typical reverse cascade rinsing system utilises three to six compartments with wringer rolls to reduce carry-over between compartments. Fresh or condensate water to be added to the last compartment is allowed to cascade countercurrently over a weir to the preceding compartment. The excess (e.g. drag-out) overflows from the first compartment to a storage tank from where it is usually passed to the regeneration plant. Portions from the intermediate tanks are taken for acid vapour absorption in the absorption columns of the regeneration plant or for fresh acid dilution in the pickling tanks.

Figure 8.34 shows a variety of rinsing techniques available; ranging from the simplest single rinse flow method to more sophisticated combined rinsing systems. Multiple (cascade) use of rinse water and static rinse tanks result in sufficiently high concentrations in the rinse water to allow for the reuse in preceding process baths or to allow for regeneration or reclamation measures applied to the process baths to be applied to the rinse water as well.

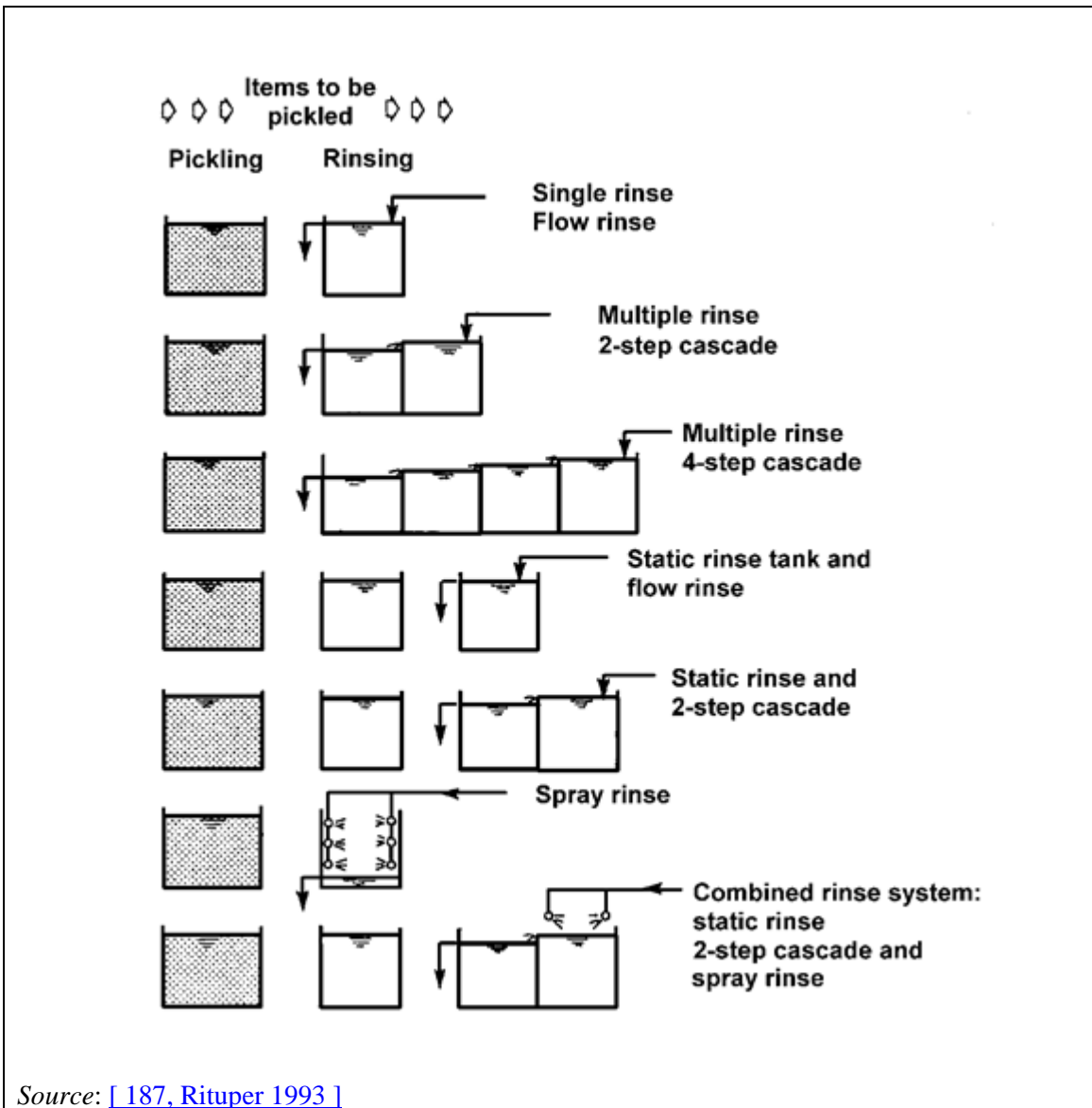


Figure 8.34: Rinsing systems

Achieved environmental benefits

- Reduction of water consumption.
- Reduction of the volume of waste water generated.

Environmental performance and operational data

Water consumption levels associated with different rinsing systems are listed in Table 8.8. Rinsing systems with a single flow rinse step (i.e. 'Flowrinse' and 'Static and flow rinse') show by far the highest water consumption levels.

Table 8.8: Comparison of water consumption levels for different rinsing systems

Concentration in pickling bath [g/l]		100				200				600			
Residual concentration in last rinse bath [mg/l]		5	10	20	50	5	10	20	50	5	10	20	50
Rinse criteria		$2 \cdot 10^4$	10^4	$5 \cdot 10^3$	$2 \cdot 10^3$	$4 \cdot 10^4$	$2 \cdot 10^4$	10^4	$4 \cdot 10^3$	$1.2 \cdot 10^5$	$6 \cdot 10^4$	$3 \cdot 10^4$	$1.2 \cdot 10^4$
Rinse system	Number of Baths	Rinse water consumption [m ³ /h]				Rinse water consumption [m ³ /h]				Rinse water consumption [m ³ /h]			
Flowrinse	1	2000	1000	500	200	4000	2000	1000	400	12000	6000	3000	1200
2-step cascade	2	14.1	10	7.1	4.5	20	14.1	10	6.3	34.6	24.5	17.3	11
3-step cascade	3	2.7	2.1	1.7	1.3	3.4	2.7	2.1	1.6	5.0	4.0	3.1	2.3
4-step cascade	4	1.2	1.0	0.9	0.7	1.4	1.2	1.0	0.8	1.9	1.6	1.3	1.0
Static and flow rinse	2	400	200	100	40	800	400	200	80	2400	1200	600	240
Static rinse 2-step cascade	3	6.3	4.5	3.2	2.0	9.0	6.3	4.5	2.9	15.5	11.0	7.7	4.9
Static rinse 3-step cascade	4	1.6	1.3	1.0	0.7	2.0	1.6	1.3	0.9	2.9	2.3	1.8	1.3
Spray rinse Efficiency 100 %	1	9.9	9.2	8.5	7.6	10.6	9.9	9.2	8.3	11.7	11.0	10.3	9.4
Spray rinse Efficiency 30 %	1	3.3	3.1	2.9	2.6	3.6	3.3	3.1	2.8	4.0	3.7	3.5	3.2

NB: Carry-over 100 l/h.
Source: [187, Rituper 1993]

Cross-media effects

None.

Technical considerations relevant to applicability

Applicability to existing plants may be restricted by a lack of space.

Economics

No information provided.

Driving force for implementation

Reduced costs due to reduced water consumption and reduced waste water generation.

Example plants

Reverse cascade rinsing is widely used. Example plants include Jenn Ann, Taiwan and Herning Varmforzinkning A/S, Denmark (see Section 8.6.3.1).

Reference literature

[[187, Rituper 1993](#)].

8.7.6 Recycling or reuse of rinsing water

Description

Water from rinsing after pickling or degreasing is recycled/reused, if necessary after treatment, to the preceding process baths as make-up water, rinsing water or, if the acid concentration is sufficiently high, for acid recovery.

Technical description

When the water in rinsing tanks becomes too contaminated to secure efficient rinsing, the water is recycled to the preceding process bath as make-up water for evaporation losses and drag-out or reused as rinsing water.

A physico chemical treatment can be used to treat the rinsing water to a level where it can be reused in the rinsing tanks. This leads to an additional reduction in the water consumption of the plants. Also, this treatment may lead to lower contamination in the rinsing water (e.g. Fe) which would maximise the effects of technique 8.6.3.1 (i.e. minimise the carry-over of iron to the fluxing solution). [[32, Pre-FD comments 2021](#)]

Achieved environmental benefits

- Reduction of water consumption.
- Reduction of the volume of waste water generated.
- A physico chemical treatment before reuse can reduce the carry over of iron to the fluxing solution and therefore reduce the generation of spent fluxing solution. [[32, Pre-FD comments 2021](#)]

Environmental performance and operational data

With a proper design and operational practice, all rinsing water can be recycled or reused in batch galvanising plants.

Cross-media effects

Consumption of chemicals and energy in treatment for reuse. [[32, Pre-FD comments 2021](#)] [[32, Pre-FD comments 2021](#)]

Technical considerations relevant to applicability

Generally, there are no technical restrictions to the applicability of this technique.

Economics

No information provided.

Driving force for implementation

Reduced costs due to reduced water consumption and reduced waste water generation.

Example plants

Basically all galvanising plants recycle rinsing water. An example plant is described in Section 8.6.3.1. Reuse is only rarely applied. [\[32, Pre-FD comments 2021 \]](#)

Reference literature

[\[32, Pre-FD comments 2021 \]](#).

8.7.7 Cooling water systems**Description**

Separate and closed cooling water systems are applied with recooling of the water by evaporative towers or plate heat exchangers (cooling media can also be seawater or other available media). In order to operate closed cooling water cycles, the cooling water has to be re-cooled and treated, depending on the type of cooling system. Cooling water may be recirculated to minimise consumption by rejecting the heat via evaporative cooling towers or secondary cooling circuits. [\[25, EUROFER 2018 \]](#)

Technical description

In order to run cooling water in closed loops and thus reduce the water consumption, the cooling water has to be re-cooled and treated.

Cooling is carried out either by evaporation in cooling towers, heat exchangers using a secondary cooling system or hybrid cooling towers. In pressure-cooled counterflow **cooling towers**, the water to be cooled is sprayed on grids in the cooling tower cells and trickles over blocks into the cooling tower tray. Fans arranged laterally or on top draw in ambient air which passes the water in counterflow. Thus cooling is achieved by evaporation of water. The cooling efficiency is controlled by means of the air volume. Desalting is controlled via a measurement of the electrical conductivity. If required, the necessary amount of dispersants, sodium hypochlorite and biocide (prevention of growth of bacteria and fungi) and acid or alkali (pH value) is added. [\[4, EUROFER 1998 \]](#), [\[25, EUROFER 2018 \]](#)

In **plate heat exchangers**, plates with through-flow channels are stacked up. Between the plates, alternately warmed up water and secondary cooling water is pumped through, enabling heat exchange between the two fluids via the plate walls. Sources for secondary cooling water are mostly open water sources like rivers, lakes or sea, and it can be pretreated to decrease fouling in the system. [\[4, EUROFER 1998 \]](#), [\[25, EUROFER 2018 \]](#)

In **hybrid cooling towers**, a plate heat exchanger is installed in the upper part of the tower. In the lower part, the water is cooled by evaporation. Due to the heat exchanger, the air with 100 % moisture is heated and condenses as fog some time later and with less intensity.

In the planning and installation of circuit-type water treatment plants with cooling towers, the geographical situation of the respective mill has to be taken into consideration. Due to the water evaporation in the recooling process, climatic conditions can be affected by the constant formation of fog and by so-called industrial snow, especially in central Europe. [\[4, EUROFER 1998 \]](#)

Achieved environmental benefits

Reduced water consumption as water can be reused in the process.

Environmental performance and operational data

Cold rolling (example of a tandem mill)

Table 8.9: Consumption and emission levels for the cooling water system of a tandem mill

Input / Consumption Level			
Cooling water (re-circulating)	8400		m ³ /t
River water	7000		m ³ /t
Soft water ¹	2.5 E -4		m ³ /t
NaOH	1.25 E -8		m ³ /t
Inhibitor	2.5 E -7		m ³ /t
Energy:			
Electrical	0.004		GJ/t
Caloric ²	0.282		GJ/t
Output / Emission Level			
	Specific Emission		Concentration
Cooling water (re-circulating)	8400	m ³ /t	
Waste water (system drain water)	2.5 E -4	m ³ /t	
Settleable solids (volume)	2 - 5	ml/l	
Hydrocarbons (oil, grease)	2 - 5	mg/l	0.5 - 1.25 mg/t
Chlorides	50	mg/l	12.5 mg/t
Fe total	2	mg/l	0.5 mg/t
Temperature	35	°C	
pH	6.5 - 9.5		
Electric conductivity	1.1	mS/cm	
¹ only in case of system drainage			
² energy removed from tandem mill by cooling water			
Source: [89, EUROFER, TG Cold Rolling 1998]			
Data based on weekly, volume proportional 24-h sampling			

Example of annealing furnaces

The annealing furnaces (e.g. batch annealing in a controlled atmosphere of 75 % H₂, 25 % N₂ (or sometimes 100 % H₂) are equipped with a water cooling system in order to maintain both the fan motors brackets situated at the base of the furnaces and the furnace bell at low temperature. The cooling circuit has a water tank that is reintegrated every time a minimum level is reached. The frequency of reintegration of the water tank is dependent on production. The water is cooled by evaporative towers and then reused. [70, EUROFER 31-5-17 2017]

Cross-media effects

- Addition of dispersants and of biocides for cooling water treatment. [26, Hot Rolling Shadow Group 1999]
- Increased energy consumption as a result of recirculation pumping requirements. [14, Hot Rolling Shadow Group 2000]
- Due to the water evaporation in the recooling process, the climatic conditions can be affected by the constant formation of fog and by the so-called industrial snow, especially in central Europe. [25, EUROFER 2018]

Technical considerations relevant to applicability

- Applicability to existing plants may be restricted by a lack of space. [25, EUROFER 2018]
- Depending on local conditions, in some plants once-through water cooling systems are applied (see Section 2.2.17 and BAT conclusions in the IS BREF [22, COM 2013] and ICS BREF). [25, EUROFER 2018]
- Once-through systems are commonly applied to large-capacity installations, e.g. iron and steel integrated works in locations where sufficient cooling water and receiving surface

water are available. Using a once-through system has the advantage of avoidance of industrial snow and ice formation during winter time in cold climatic European regions, resulting from condensating steam emissions from cooling towers. If a reliable water source is not available, recirculating systems (cooling towers) are used (see the IS BREF and ICS BREF). [\[25, EUROFER 2018 \]](#)

Economics

Beside the costs for installing and operating a cooling water system, the expenditure for maintenance needs to be considered. Micro- and macro-fouling inside the heat exchangers and cooling water pipes increases the pressure loss and decreases the heat transfer, causing higher energy consumption for recirculation. Periodic maintenance is necessary to preserve the efficiency of the system. [\[25, EUROFER 2018 \]](#)

Driving force for implementation

Reduced water consumption.

Example plants

Widely used.

Reference literature

[\[14, Hot Rolling Shadow Group 2000 \]](#), [\[22, COM 2013 \]](#), [\[25, EUROFER 2018 \]](#), [\[26, Hot Rolling Shadow Group 1999 \]](#), [\[188, COM 2001 \]](#).

8.8 General techniques to reduce emissions to air

8.8.1 End-of-pipe techniques

8.8.1.1 Demister

Description

Demisters, also called droplet or entrainment separators or mist eliminators, are filter devices that remove entrained liquid droplets from a gas stream. They consist of a structure of metal, plastic or fibre, with a high specific surface area. Through their momentum, small droplets present in the gas stream impinge against the filter structure and coalesce into bigger drops. The main types of demisters are wire-mesh, fibre-bed and baffle-type demisters and can either be used as a separate piece of equipment, or part of another piece of equipment, e.g. a wet scrubber (see Section 8.8.4.3).

Reference literature

[\[167, Pinasseau et al. 2018 \]](#), [\[168, COM 2016 \]](#).

8.8.1.2 Electrostatic precipitator (ESP)

Description

Electrostatic precipitators (ESPs) operate such that particles are charged and separated under the influence of an electrical field. Electrostatic precipitators are capable of operating under a wide range of conditions. The abatement efficiency may depend on the number of fields, residence time (size), and upstream particle removal devices. They generally include between two and five fields. Electrostatic precipitators can be of the dry or the wet type depending on the technique used to collect the dust from the electrodes. Wet ESPs are typically used at the polishing stage to remove residual dust and droplets after wet scrubbing.

Reference literature

[\[167, Pinasseau et al. 2018 \]](#), [\[168, COM 2016 \]](#).

8.8.1.3 Fabric filter

Description

Fabric filters, often referred to as bag filters, are constructed from porous woven or felted fabric through which gases are passed to remove particles. The use of a fabric filter requires the selection of a fabric suitable for the characteristics of the waste gas and the maximum operating temperature.

Reference literature

[\[167, Pinasseau et al. 2018 \]](#), [\[168, COM 2016 \]](#).

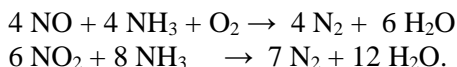
8.8.1.4 Selective catalytic reduction (SCR)

Description

The SCR technique is based on the reduction of NO_x to nitrogen in a catalytic bed by reaction with urea or ammonia at an optimum operating temperature of around 300–450 °C. Several layers of catalyst may be applied. A higher NO_x reduction is achieved with the use of several catalyst layers.

Technical description

The SCR process is the most highly developed and widely used method for NO_x removal from exhaust gases. The process involves the reduction of NO and NO₂ to N₂ of ammonia over a catalyst bed. The overall reactions are:



The optimum temperature window for these reactions is 300–400 °C. Usually, ammonia is added slightly sub-stoichiometrically (0.9–1.0 mole per mole of NO_x) to suppress carry-over. [9, ETSU - c 1993], [51, Davies et al. 1995]

The most effective and widely used catalyst is vanadium pentoxide (V₂O₅) supported on TiO₂. Other substances exhibiting catalytic activity are Fe₂O₃ and CuO, the noble metals (Pt, Pd, Ru, Rh), oxides of the metals W, Mo, Cr, Co and Ni or certain zeolites and activated carbon. The catalyst may be employed in a variety of structures and configurations to alleviate the problem of blockage by particulates depending on the severity of the problem. A honeycomb-shaped catalyst is suitable in a fixed bed configuration because it permits the particles to pass through without clogging. A moving bed configuration allows a deactivated or clogged catalyst to be constantly regenerated. A parallel-flow arrangement is also suitable. [51, Davies et al. 1995]

Deactivation by poisoning (Na, K, As), erosion or solids contamination may limit the lifetime of the catalyst. [4, EUROFER 1998]

The efficiency of NO_x reduction by SCR depends on the catalyst used and the initial NO_x concentration. Values up to 95 % have been reported, with a typical range being 70–90 %. [48, ETSU 1996], [51, Davies et al. 1995]

More specific information regarding this technique at hot rolling and cold rolling plants may be found in Sections 2.4.2.9 and 3.4.3.5, respectively.

A table is provided in Annex 11.9 which compares the advantages and disadvantages of this technique with other NO_x emission reduction techniques.

Reference literature

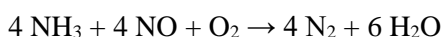
[4, EUROFER 1998], [9, ETSU - c 1993], [48, ETSU 1996], [51, Davies et al. 1995]

8.8.1.5 Selective non-catalytic reduction (SNCR)**Description**

SNCR is based on the reduction of NO_x to nitrogen by reaction with ammonia or urea at a high temperature. The operating temperature window is maintained between 800 °C and 1 000 °C for optimal reaction.

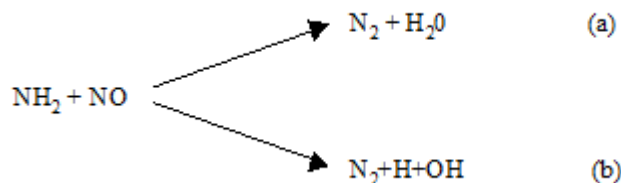
Technical description

In this process, also known as the thermal De-NO_x process, ammonia or urea is injected directly into the flue-gas at higher temperatures than SCR, to reduce NO to N₂, without the aid of a catalyst. To ensure the maximum possible reduction of NO_x, it is necessary to inject ammonia or urea at a point in the process where the exhaust gas temperature is within an optimum range. For ammonia, the range is between 850 °C and 1 000 °C and for urea the range is from 950 °C to 1 100 °C. The overall reaction is:



The presence of excess O₂ in the exhaust gas is thus required, as well as a residence time of 0.1 to 0.4 seconds. A feature of this process is that it is only effective over a narrow temperature window. [51, Davies et al. 1995]

The reaction mechanism is a homogeneous gas phase one, the key step being:



The chain-branching channel (b), producing radicals, is crucial to sustaining the reaction; without it, the reaction would quickly terminate. This reaction is in competition with reactions of NH₂ with oxidising radicals (O, OH) which lead to the formation of NO. This competition explains the existence of the temperature window. At temperatures below the low temperature limit, NO reduction is limited by radical chain termination steps in the mechanism competing effectively with chain-branching steps; at temperatures above the high temperature limit, NH₃ oxidation dominates over NO reduction, leading to net NO formation. Additives influence this window by altering the balance between these processes. [51, Davies et al. 1995]

Ammonia is potentially explosive and its safe storage would be a significant consideration with cost implications. [51, Davies et al. 1995]

More specific information regarding this technique at hot rolling plants may be found in Section 2.4.2.10.

A table is provided in Annex 11.9 which compares the advantages and disadvantages of this technique with other NO_x emission reduction techniques.

Reference literature

[51, Davies et al. 1995].

8.8.1.6 Optimisation of the SNCR/SCR design and operation

Description

Optimisation of the reagent to NO_x ratio over the cross-section of the furnace or duct, of the size of the reagent drops and of the temperature window in which the reagent is injected.

Technical description

A possible disadvantage of the SCR/SNCR techniques is related to the ammonia slip, which is the emission of unreacted ammonia into the environment.

This occurs in the case of incomplete reaction of NH₃ with NO_x, when small amounts of NH₃ leave the reactor / combustion chamber with the flue-gas, and may be due to catastrophic failure of the whole SCR system or to an increase of the NH₃ to NO_x ratio when looking to increase the SCR/SNCR system efficiency. This effect is known as ammonia slip. High ammonia slip (NH₃ breakthrough) can lead to the following:

- Unwanted ammonia emissions into the environment.
- The formation of ammonium sulphates, which form deposits on downstream systems such as the catalyst and air preheater and on surfaces below 235 °C, or can result in increased dust emissions. Deposits can be minimised by keeping the ammonia slip low and

monitoring the downstream flue-gas temperature. Deposits can be cleaned on-line by water washing or by raising metal temperatures above the condensation temperature to sublime deposits with suitably designed materials.

Controlling the ammonia slip in SCR/SNCR can be done in a number of ways that are summarised below:

- The ammonia slip at SCR and SNCR installations increases with an increasing NH_3 to NO_x ratio, but also, with SCR, with decreasing catalyst activity.
- The SCR system needs regular planned maintenance or inspection, e.g. annually, in order to prevent ammonia slip. For instance, with high ammonia slip, harmful salt deposits can occur on the internal surfaces of the components sited after the reactor.
- Limiting the ammonia slip for SCR systems can be solved by using a larger catalyst volume and/or by improving the mixing of NH_3 and NO_x in the flue-gas.
- In the case of SNCR, the ammonia slip increases with poor NH_3 and flue-gas mixing conditions, due to lack of residence time within the reaction temperature window, and with an increasing NH_3 to NO_x ratio. To avoid ammonia slip with the SNCR technique, a layer of SCR catalyst can be installed in the economiser area of the boiler. As this catalyst reduces the ammonia slip, it also reduces the corresponding amount of NO_x .

Both SCR and SNCR techniques require the use of ammonia or urea as a reducing agent. A number of health and safety risks related to the use of pure liquefied ammonia exist (e.g. for the handling and storage of pure liquefied ammonia, pressure reservoirs may need to be double-walled and located underground). No impact on health arises from solid urea storage. From a safety point of view, the use of an ammonia-water solution is less risky than the storage and handling of pure liquefied ammonia.

The most common form of ammonia used for SCR and SNCR is aqueous ammonia, normally available in a 24.5 % concentration or lower. Aqueous ammonia is a non-flammable liquid, and is classified as an irritant. Aqueous ammonia can be stored under atmospheric conditions. Pure anhydrous ammonia is classified as a flammable, toxic and corrosive gas, and is combustible in air concentrations between 15 % and 28 % and has to be stored under pressure (vapour pressure of 7.6 bar at 20 °C).

Because of the high risk of ammonia to human health, ammonia transportation, handling and storage need to be carried out very carefully to avoid any leakage.

Achieved environmental benefits

Minimisation of ammonia emissions from SCR/SNCR.

Environmental performance and operational data

At SSAB Borlänge cold rolling mill (Sweden), in the SCR reactor, a solution containing 25 % NH_3 is injected in the waste gases. The working temperature of the catalyst is between 160 °C and 400 °C and the injection of the NH_3 solution is only done when the waste gas temperature is within this range. The measured NH_3 emissions during the first years of operation at SSAB showed that emission concentrations were within the range of 2-3 ppm NH_3 .

In order to avoid problems with the smell of the flue-gas in surrounding areas, the ammonia concentration associated with the use of SCR or SNCR is usually kept below 10 mg/Nm³.

Cross-media effects

Incomplete reaction of NH_3 with NO_x may result in the formation of ammonium sulphates, which are deposited on downstream systems such as the catalyst and air preheater. This incomplete reaction only occurs in the very unlikely case of catastrophic failures of the whole SCR system.

The use of ammonia gas, transport and storage can be hazardous and subject to stringent safety regulations.

Technical considerations relevant to applicability

Only applicable where SNCR/SCR is used for the reduction of NO_x emissions.

Economics

No information provided specifically related to the FMP sector.

General information on the costs of implementation of SCR/SNCR may be found in the LCP BREF (Sections 3.2.2.3.11 and 3.2.2.3.12). [[23, Lecomte et al. 2017](#)]

Driving force for implementation

Reduction of NO_x emissions.

Example plants

SSAB Borlange, (110HR – Tata Steel Ijmuiden)

Reference literature

[[23, Lecomte et al. 2017](#)].

8.8.1.7 Wet scrubbing

Description

The removal of gaseous or particulate pollutants from a gas stream via mass transfer to a liquid solvent, often water or an aqueous solution. It may involve a chemical reaction (e.g. in an acid or alkaline scrubber). In some cases, the compounds may be recovered from the solvent.

Reference literature

[[167, Pinasseau et al. 2018](#)].

8.8.2 Emissions to air from heating

8.8.2.1 Use of electricity generated from fossil-free energy sources for heating

Description

Use of electric furnaces in the hot rolling, cold rolling, hot dip coating, wire drawing and batch galvanising heating processes (e.g. annealing, heat treatment before hot dipping, heating of galvanising kettles) to prevent or reduce dust, SO₂ and NO_x emissions (while limiting CO emissions).

The electricity used is generated from fossil-free energy sources (e.g. hydroelectric, solar, wind, nuclear).

Technical description

The main heating processes used in the FMP sector are summarised below:

- in HR: reheating, intermediate heating and post-heating (e.g. tempering, quenching, normalising);
- in CR: continuous / batch annealing, heat treatment (e.g. soaking, over-ageing furnaces);
- in WD: continuous / batch annealing;
- in HDC: heat treatment before hot dipping, galvannealing;
- in BG: heating of the galvanising kettle.

This technique consists of operating the FMP heating processes mentioned above using electricity. In order to ensure that emission reductions at the FMP site are not counterbalanced by emissions and other potential negative environmental impacts from power generation, electricity generated from fossil-free energy sources is used. Green energy certificates and/or a Guarantee of Origin as specified in Directive 2018/2001 on the promotion of the use of energy from renewable sources can provide information to the operator on the source of the electricity supply.

At the time of writing this document (2022), electric furnaces are not commercially available in hot rolling (HR) for reheating and intermediate heating. For post-heating, however, electric furnaces may be used in some processes and have been reported in the FMP data collection. In other FMP sectors (i.e. CR, WD, HDC and BG), electric furnaces are commercially available; however, their use is not widespread due to technical and/or economic reasons. This was confirmed by the FMP data collection in which only a relatively small number of plants reported the use of electric furnaces (see example plants section below).

Achieved environmental benefits

- Elimination of emissions of CO, SO₂ and NO_x and reduction of dust emissions from FMP heating processes on site.
- Reduction and/or avoidance of CO, SO₂, NO_x and dust emissions from power generation.
- Improved energy efficiency of the heating process.
- Prevention or limitation of negative impacts to the environment as a whole, e.g. emissions to air, water and soil as well as use of resources and waste generation.

Environmental performance and operational data

The use of this technique can lead to substantial reductions in terms of CO, dust, SO₂ and NO_x emissions at the FMP plant.

The overall thermal efficiency of gas-fired furnaces generally ranges from 50 % to 70 % depending on the type of furnace and taking into consideration preheating of combustion air. In the case of electric furnaces, all the heat generated is transferred directly into the furnace chamber, leading to a much higher thermal efficiency, reaching almost 90 %. Therefore, the use of electric furnaces results in a significant reduction in the overall energy consumption

Cross-media effects

- In the case of gas-fired batch annealing furnaces, inert gases are usually purged and combusted in a special burner. The energy content of the purged gases (i.e. 3-5 % of total energy content) may be lost in the case of electric heating.
- Energy generation from fossil-free energy sources may have other environmental impacts (e.g. dust generation from electricity production from biomass combustion, generation of nuclear waste materials in nuclear power plants, noise emissions from wind turbines).

Technical considerations relevant to applicability

The following factors may need to be considered in relation to the selection of the furnace type (electric or fuel-fired):

- *Availability of electrical power output:* The use of electricity in heating processes is dependent on the available electrical power output (expressed in MW) that can be delivered from the nearby electrical grid. In some cases, the available power output from the electrical grid (MW) may be insufficient to supply the high power output required by electric furnaces.
- *Availability of electricity from fossil-free energy sources:* The current energy policy of the European Union promotes decarbonisation of electricity generation. Accordingly, the share

of fossil-free electricity in the European electricity mix is expected to rise drastically in the short to medium term. However, there are still significant differences between Member States in terms of the sources of electricity production. In 2022, for instance, in France the share of electricity production from fossil-free energy sources (wind, solar, nuclear, biomass, hydroelectricity – about 87 %) largely outweighs the share of electricity production from natural gas or coal (about 13 %). In Poland, however, the share of electricity production from coal and natural gas is very significant (about 71 %).

- *Utilisation of iron and steel process gases:* There is a need to maximise the utilisation of valuable process gases in the case of integrated steelworks (e.g. coke oven, blast furnace and basic oxygen furnace gases). Without recovery of their energy content, these gases may need to be flared.
- *Space availability (conversion of existing plants):* In the evaluation of the viability of conversion to electric heating, the power or heat load requirements of the existing furnace and suitable electrical supply infrastructure are important considerations. In general, conventional fuel-fired burners deliver a higher power density (kW/m³) in the furnace compared to electric heating. Therefore, electric heating elements may require more space compared to conventional burners. In some cases, it may be necessary to extend the length of the furnace or to build a new one (if space is available) in order to maintain sufficient power load and/or production capacity.
- *High-temperature processes:* Electric furnaces may not be the most suitable for processes involving very high temperatures (> 1 000 °C), e.g. reheating in hot rolling. In this case, conventional fuel-fired burners may be preferred because they provide higher power density.
- *Back-up power supply:* Sufficient back-up power supply (e.g. diesel generators) may be required in order to assure continuous operation, especially for melting furnaces in HDC and BG.

Economics

The choice between gas-fired furnaces and electric ones will be based on the availability of technical options and their respective costs.

The costs for converting a gas-fired furnace to an electric furnace can be close to those of the replacement of an entire furnace. Besides the conversion of the furnace, costs related to the electrical infrastructure (transformers/substations, supply cable upgrades, switchboard and connection to the furnaces) have to be considered.

The costs of fossil-free electricity in comparison to fossil fuels or gases is a key economic factor, with sizeable differences across the EU.

Some French sites have reported an increase of 40 % to 50 % in the lifetime of their furnace linings when electric furnaces are used, because there are no hotspots caused by fuel-fired burners. This results in cost savings.

Driving force for implementation

- Increased energy efficiency.
- Elimination of emissions from thermal processes on site (at the FMP plant) and from the generation of electricity.
- Decarbonisation and integrated pollution prevention of the FMP plant.
- Improved process/temperature control.
- Improved workplace conditions in the vicinity of the furnace.

Example plants

Several hot rolling plants in Sweden and Finland (belonging to Ovako) have converted existing gas-fired heat treatment furnaces (post-heating furnaces) to electric furnaces.

A number of plants in the FMP data collection reported the use of electric furnaces; however, the source of electricity was not reported in the FMP data collection for these plants. They are summarised below, and where available, the target temperature is also provided.

For these plants, it is important to note that electricity provides only a small proportion of the total power used at the plant, except for batch galvanising plants, where the electrical power required for the heating of the kettle constitutes the principal use of electrical power in the plant.

Hot rolling:

Annealing furnaces: 239 HR - target temperature of 800 °C, 248 HR1, 248 HR2.

Tempering furnaces: 243 HR.

Cold rolling:

Annealing furnaces: 98 CR.

Soaking furnaces: 37 HR - target temperature of 660 °C to 825 °C, 94 CR, 194 CR - target temperature of 730 °C.

Over-ageing furnaces: 37 CR, 94 CR, 98 CR, 179 CR, 194 CR - target temperature of 400 °C, 244°CR - target temperature of 200 °C.

Wire drawing:

Continuous annealing: 245 WD - target temperature of 1 050 °C.

Hot dip coating:

Heat treatment furnaces before hot dipping: 159 HDC: soaking furnace / target temperature range of 740 °C to 840 °C).

Galvannealing (induction heating): 159 HDC, 249 HDC - target temperature of 560 °C.

Batch galvanising:

Heating of the galvanising kettle: 103, 166, 169, 233, 234, 235, 236.

Reference literature

[[16, FMP TWG 2018](#)], [[209, FMP TWG 2022](#)].

8.8.2.2 Use of fuels with low dust or ash content

Description

Fuels with low dust and ash content include e.g. natural gas, liquefied petroleum gas, dedusted blast furnace gas and dedusted basic oxygen furnace gas.

Technical considerations relevant to applicability

Generally applicable.

More information on the relevant iron and steel process gases

See Section 2.4.2.1.

8.8.2.3 Limiting the entrainment of dust

Description

Entrainment of dust is limited by for example:

- As far as practically possible, use of clean feedstock or cleaning the feedstock of loose scale and dust before feeding it into the furnace;
- minimisation of dust generation from refractory lining damages by e.g., avoiding direct contact of the flames with the refractory lining, using ceramic coatings on the refractory lining;
- avoiding direct contact of the flames with the feedstock.

Technical description

No information provided.

Achieved environmental benefits

Reduction in dust emissions.

Environmental performance and operational data information

No information provided.

Cross-media effects

No information provided.

Technical considerations relevant to applicability

Avoiding direct contact of the flames with the feedstock is not applicable in the case of direct flame furnaces.

Economics

No information provided.

Driving force for implementation

Reduction of dust emissions.

Example plants

No information provided.

Reference literature

[[210](#), [UNEP 2014](#)].

8.8.2.4 Use of a fuel or a combination of fuels with low sulphur content

Description

Fuels with low sulphur content include e.g. natural gas, liquefied petroleum gas, blast furnace gas, basic oxygen furnace gas and CO-rich gas from ferrochromium production.

Technical considerations relevant to applicability

Generally applicable.

More information on the relevant iron and steel process gases

See Section 2.4.2.1.

8.8.2.5 Use of a fuel or a combination of fuels with low NO_x formation potential

Description

Fuels with a low NO_x formation potential, e.g. natural gas, liquefied petroleum gas, blast furnace gas and basic oxygen furnace gas.

Technical considerations relevant to applicability

Generally applicable.

More information on the technique

See Section 2.4.2.1.

8.8.2.6 Furnace automation and control

See Section 8.5.3.3.

8.8.2.7 Combustion optimisation

See Section 8.5.3.2.

8.8.2.8 Low-NO_x burner

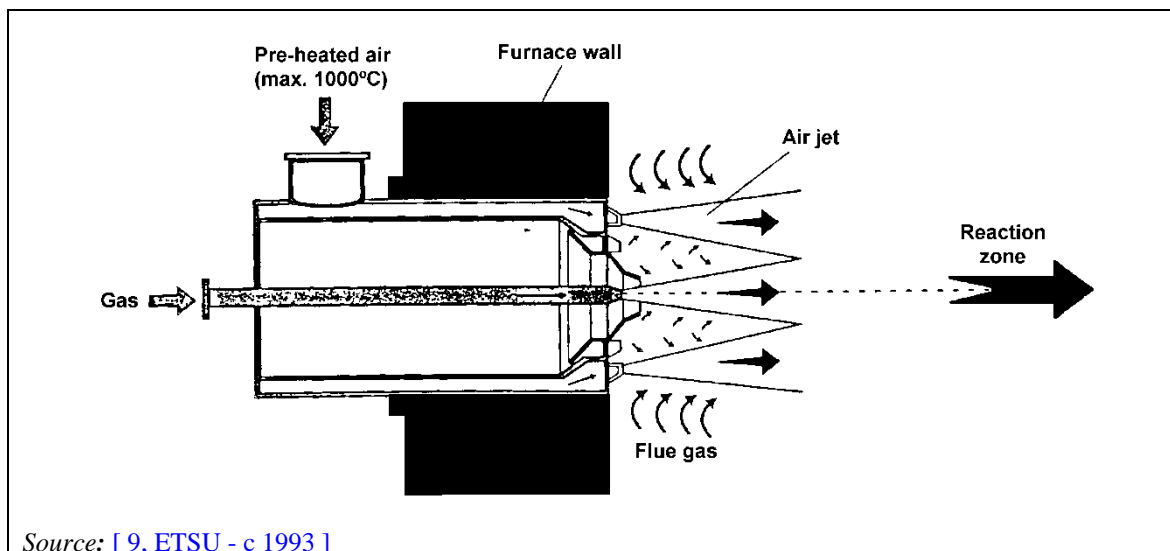
Description

The technique (including ultra-low-NO_x burners) is based on the principles of reducing peak flame temperatures. The air/fuel mixing reduces the availability of oxygen and reduces the peak flame temperature, thus retarding the conversion of fuel-bound nitrogen to NO_x and the formation of thermal NO_x, while maintaining high combustion efficiency.

Technical description

Low-NO_x burner is a general term for a series of burners that combine several design features to reduce the NO_x emission level. The main principles of these burners are the reduction in peak flame temperature, the reduction in residence time in the high-temperature zone and the reduction in oxygen availability in the combustion zone. This is generally achieved by air staging, fuel staging and/or internal flue-gas recirculation. [51, Davies et al. 1995] As there is a multitude of different burner designs, also varying from supplier to supplier, Figure 8.35 and Figure 8.36 show only a selection of the different low-NO_x burners available.

The **recirculation of the flue-gases** from the furnace into the flame can be favoured by burner design as shown in Figure 8.35. This lowers the O₂ concentration in the air/fuel mixture and creates a quiet flame with a lower temperature. The recirculation also achieves a chemical reduction of the NO_x in the flue-gases by the hydrocarbons in the fuel. [4, EUROFER 1998]



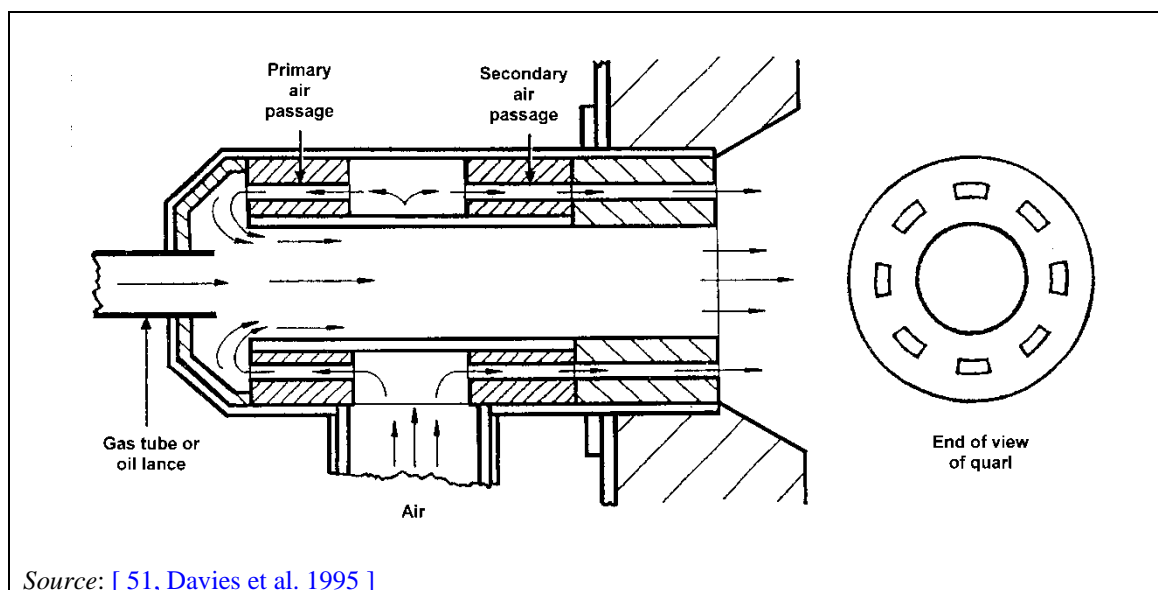
Source: [9, ETSU - c 1993]

Figure 8.35: Schematic of a low-NO_x burner with internal flue-gas recirculation

A further reduction of the NO_x level and of the dependency of the NO_x level on the air preheat temperature can be achieved by burners with an increased jet flow, where the flame in some cases is not anchored to the tile of the burner or where the gas and combustion air inlets are separated. [4, EUROFER 1998]

A common mode of operation of low- NO_x burners is the creation of a fuel-rich zone within the flame. This favours the conversion of fixed nitrogen, chemically bound fuel-nitrogen, to N_2 . It also has the effect of reducing the peak flame temperature. Both fuel and thermal NO_x mechanisms are retarded and the formation of NO_x is reduced. There are two main types of low- NO_x burners which both involve the use of staged combustion to achieve the desired effect. These are air-staged and fuel-staged burners.

In **air-staged burners**, the first stage of combustion occurs in a slightly fuel-rich zone, at an optimum fuel to air ratio (1.1–1.3) for conversion of the fuel nitrogen to N_2 . A second stage of combustion is operated fuel-lean by addition of secondary air in such a way as to complete the fuel burnout, with careful temperature control to minimise the formation of thermal NO in this zone.



Source: [51, Davies et al. 1995]

Figure 8.36: Schematic example of an air-staged low- NO_x burner

There are various designs of air-staged burners which differ in the way the two combustion zones are created. In aerodynamically air-staged burners, all the combustion air flows through the same burner opening, in such a way that aerodynamics is used to create the first fuel-rich zone. External air-staged burners use a separate air stream to complete burnout. In air-staged pre-combustor burners, the fuel-rich zone is established in a separate pre-combustor section. Key design factors controlling the effectiveness of air-staged burners are the temperature and residence time in each stage. [51, Davies et al. 1995]

In **fuel-staged burners**, NO is allowed to be formed in the primary combustion zone, but fuel is injected downstream to create a secondary fuel-rich, or 'reburn' zone where the NO is reduced to N_2 . Further air is added downstream to complete combustion of the excess fuel in a tertiary combustion zone, again with careful control of temperature to minimise thermal NO formation. Reburn fuels can be natural gas or coal.

The key reactions responsible for conversion of NO to N_2 in the fuel-rich zones of both types of low- NO_x burners are those between NO and small hydrocarbon- and nitrogen-containing radicals (such as CH , CH_2 , NH , NH_2 , NCO) which are present under these conditions. The mechanisms of NO_x chemistry are complex and the effectiveness of the methods described here to reduce NO_x formation depends on a number of factors including burner design, operation, fuel quality (particularly the volatile and fuel-nitrogen content), particle size (especially for liquid and solid fuels) and scale of operation.

Low-NO_x staged combustors are the most applicable of control techniques for industrial furnaces and do not present many difficulties of installation. Some, but not all, designs of staged combustor result in lower burner exit velocities and this reduction in momentum may cause changes in furnace aerodynamics and hence problems with heat transfer distribution. Similarly, flames will tend to lengthen which may necessitate increases in excess air levels to avoid direct flame contact with the material being heated. [\[51, Davies et al. 1995 \]](#)

Low-NO_x burners can be more complex and/or bulky than conventional burners and may give rise to problems in furnace design or in retrofitting existing furnaces. The investment cost for retrofit depends on the type and size of furnace and to what degree the new burners are compatible with the existing combustion equipment. No increase of operating costs is connected with low-NO_x burners. [\[9, ETSU - c 1993 \]](#)

For ultra-low NO_x burners, a high gas flow is required. The complete mixing of the fuel and the combustion air (and the flue-gases) takes place in the furnace, which has the effect that there is no anchoring of the flame to the burner. As a result, this type of burners can only be used at furnace temperatures beyond the spontaneous ignition temperature of the fuel/air mixture. [\[189, EUROFER, TG Cold Rolling 1998 \]](#)

By injecting fuel away from the immediate vicinity of the combustion air, mixing between reactants and products of combustion is enhanced. As a consequence, the peak flame temperature is lowered, reducing the formation of thermal NO_x. In the case of high injection momentum (e.g. high velocities), the entrainment of flue-gases is increased, resulting in mild or flameless combustion. The temperature profile achieved is much smoother, with very low NO_x emissions. In order to achieve combustion under such conditions, the furnace temperature must be above the self-ignition temperature. External flue-gas recirculation can be also used to lower the NO_x emissions, with the goal of reducing the peak flame temperature by dilution with the flue-gases. [\[31, EUROFER 10-7-18 2018 \]](#)

Combustion optimisation is a key method to reduce NO_x emissions by means of reducing the excess air. By controlling the oxygen level in the furnace atmosphere (flues), efficiency is increased and NO_x emissions are reduced (less oxygen available to react with the nitrogen). Air ingress should also be avoided (e.g. furnace pressure control during door openings). Furthermore, excess air control provides additional benefits since process yield is increased (less steel oxidation). [\[31, EUROFER 10-7-18 2018 \]](#)

Fuel switching is another effective way to reduce NO_x emissions. Use of natural gas leads to lower NO_x levels. Other fuels such as process gases from iron and steel production contain nitrogen and can therefore contribute to the formation of fuel NO_x (e.g. NH₃ in coke oven gas). In addition to the standard practice of replacing N-bound fuels (coals or fuel oils) with gaseous fuels, the use of blast furnace gas reduces NO_x formation, taking into account its lower peak flame temperature. Also, fuel conditioning is important (e.g. NH₃ removal from COG which is described in the IS BREF. [\[22, COM 2013 \]](#), [\[31, EUROFER 10-7-18 2018 \]](#)

The temperature levels required in the firing of galvanising kettles in BG differ from those required in other FMP sectors (e.g. for heating furnaces in HR). In BG, the kettle wall is part of the combustion chamber and the temperature has to be kept within a narrow range for operational reasons; high enough to allow for optimal coating properties of the molten zinc, but not too high to not lead to excessive reaction of molten zinc and iron (in the kettle wall) which would lead to increased generation of hard zinc and, even more critical, could destroy the kettle itself. The zinc bath has to be kept in a narrow temperature range compensating for heat loss and/or adding energy required to heat the feedstock entering the zinc baths; these result in the variability of firing mode.

The implementation of change of burners does not always require changes to the layout of existing plants. It is acknowledged that for some cases technical restrictions may exist.

A table is provided in Annex 11.9 which compares the advantages and disadvantages of this technique with other NO_x emission reduction techniques.

Achieved environmental benefits

- Reduced NO_x emissions.
- Increased energy efficiency. [[31, EUROFER 10-7-18 2018](#)]

Environmental performance and operational data

No information provided.

Cross-media effects

No information provided.

Technical considerations relevant to applicability

Applicability may be restricted at existing plants by design and/or operational constraints.

For instance, ultra-low NO_x burners can not be used for recrystallisation in batch annealing furnaces as they require furnace temperatures beyond the spontaneous ignition temperature of the fuel/air mixture.

Economics

No information provided.

Driving force for implementation

- Reduction of NO_x emissions. [[31, EUROFER 10-7-18 2018](#)]
- Increased energy efficiency. [[31, EUROFER 10-7-18 2018](#)]

Example plants

Cold rolling plants reporting the application of low-NO_x burners

Batch annealing plants: 08 CR4, 08 CR5, 115CR1, 193 CR1, 193 CR2.

Continuous annealing plants: 08 CR3, 37 CR5, 94 CR1, 98 CR1, 130 CR1, 130 CR2.

Hot rolling plants reporting the application of low-NO_x burners:

08-09 HR, 12 HR, 37 HR, 66 HR, 88 HR, 99 HR1, 99 HR2, 106 HR, 110 HR2, 112 HR, 121 HR, 126 HR, 146 HR, 155 HR, 157 HR1, 158 HR, 172 HR, 174 HR, 178 HR, 179 HR, 205 HR, 218 HR, 219 HR, 222 HR, 230 HR, 231 HR, 242 HR, 244 HR, 246 HR2, 267 HR, 270 HR, 288 HR, 300 HR.

Reference literature

[[4, EUROFER 1998](#)], [[9, ETSU - c 1993](#)], [[23, Lecomte et al. 2017](#)], [[31, EUROFER 10-7-18 2018](#)], [[51, Davies et al. 1995](#)], [[189, EUROFER, TG Cold Rolling 1998](#)] [[206, BE 2021](#)].

8.8.2.9 Flue-gas recirculation

Description

Recirculation (external) of part of the flue-gas to the combustion chamber to replace part of the fresh combustion air, with the dual effect of cooling the temperature and limiting the O₂ content for nitrogen oxidation, thus limiting the NO_x generation. It implies the supply of flue-gas from the furnace into the flame to reduce the oxygen content and therefore the temperature of the flame.

Technical description

Flue-gas recirculation (FGR) is a technique for limiting peak flame temperatures. Recirculating flue-gases into the combustion air will reduce the oxygen to 17–19 % and lower flame

temperatures, hence limiting the formation of thermal NO_x . [51, Davies et al. 1995], [189, EUROFER, TG Cold Rolling 1998]

Figure 8.37 shows schematically the principle of FGR. The simplest method consists of recirculating the flue-gases by withdrawing them from the exhaust duct using the burner fan and mixing them with combustion air. The recirculation flow rate can be adjusted using a servo-controlled throttle valve managed by the electronic equipment of the burner. The NO_x emission reduction obtained with this method with natural gas as fuel is significant and is a function of the percentage of recirculated fumes and the type of burner used. [25, EUROFER 2018]

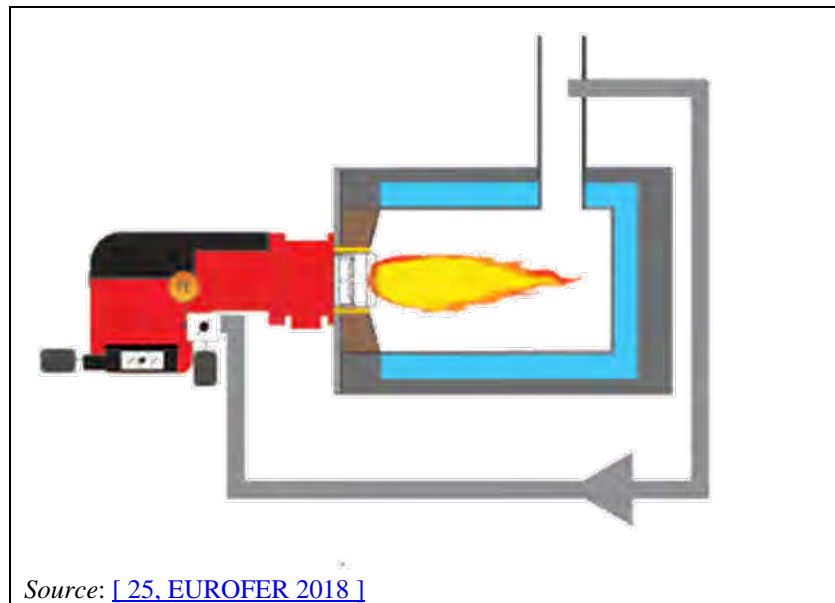


Figure 8.37: Schematic of a burner equipped with FGR

For instance, the NO_x emissions reduction achieved with FGR is shown in Figure 8.38. The diagram is based on a range of test data.

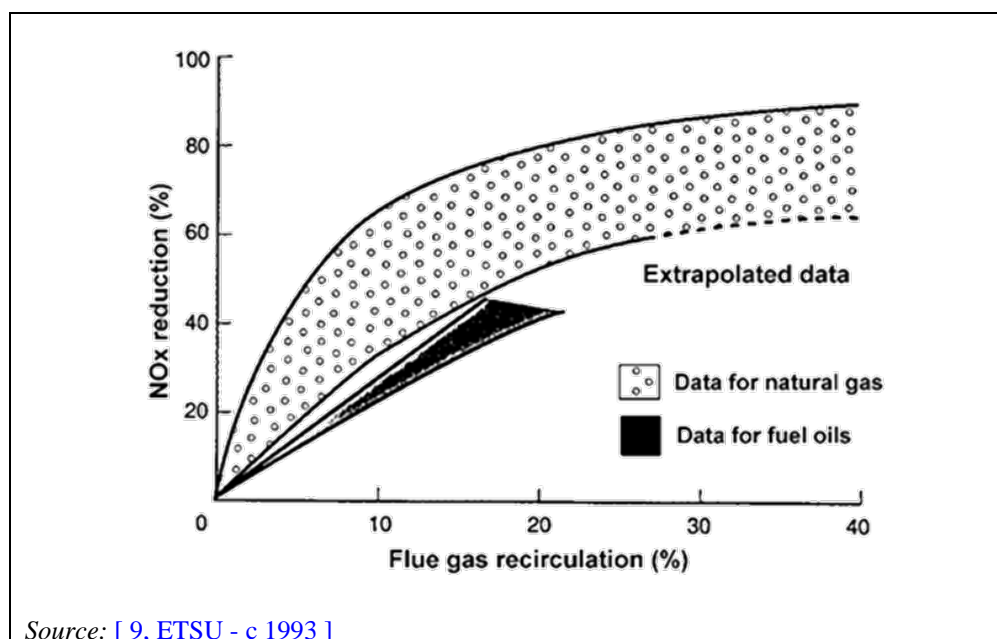


Figure 8.38: Effect of flue-gas recirculation on NO_x emission

Data obtained with several different test rigs showed that FGR can achieve NO_x reductions approaching 70–80 % depending on the fraction of the flue-gas that is recirculated (FGR 20–30 %), the temperature of the recirculated gases and whether or not the FGR is to be applied to a low-NO_x burner system. Fractional reductions compared directly to a staged combustion burner should be somewhat less, but the overall reductions with respect to the baseline should still be greater, although there are insufficient experimental results to quantify this for high-temperature industrial burners. [51, Davies et al. 1995]

A table is provided in Annex 11.9 which compares the advantages and disadvantages of this technique with other NO_x emission reduction techniques.

Achieved environmental benefits

Reduced NO_x emissions.

Environmental performance and operational data

No information provided.

Cross-media effects

Flue-gas recirculation (external) may lower the energy efficiency.

Technical considerations relevant to applicability

Applicability to existing plants may be restricted by a lack of space.

For instance, this technique requires significant ductwork to enable the flue gas recirculation which may be difficult to install, depending on the configuration of some existing plants.

Economics

No information provided.

Driving force for implementation

No information provided.

Example plants

Plants from the data collection: 203 HR, 267 HR.

Reference literature

[16, FMP TWG 2018], [25, EUROFER 2018], [51, Davies et al. 1995], [189, EUROFER, TG Cold Rolling 1998], [206, BE 2021].

8.8.2.10 Limiting the temperature of air preheating

Description

Limiting the air preheating temperature leads to a decrease of the concentration of NO_x emissions. A balance has to be achieved between maximising heat recovery from the flue-gas and minimising NO_x emissions.

Technical description

Emission levels of NO_x increase with increasing preheating temperatures of combustion air as is shown in Figure 8.39 and Figure 8.40. Limiting air preheating can be a measure to limit NO_x emissions.

On the other hand, the preheating of combustion air is a commonly applied measure to increase the energy efficiency of furnaces and to decrease fuel consumption. Limiting air preheating means that the unused energy content in the flue gas is wasted and must be compensated with higher fuel consumption. The increase in fuel consumption to be expected from reducing air preheating temperatures can be seen in Table 8.14.

Table 8.10: Calculated percentage increase in fuel consumption from reduced air preheat

		Final air pre-heat [°C]								
		1000	900	800	700	600	500	400	300	200
Initial air pre-heat [°C]	1000	0.0	6.0	12.6	19.9	28.3	37.7	48.6	60.4	74.5
	900		0.0	6.3	13.1	21.1	30.0	40.3	51.4	64.7
	800			0.0	6.4	13.9	22.2	31.9	42.3	54.9
	700				0.0	7.0	14.9	24.0	33.8	45.6
	600					0.0	7.4	15.9	25.0	36.0
	500						0.0	7.9	16.4	26.7
	400							0.0	8.4	17.4
	300								0.0	8.8
	200									0.0

Source: [9, ETSU - c 1993]

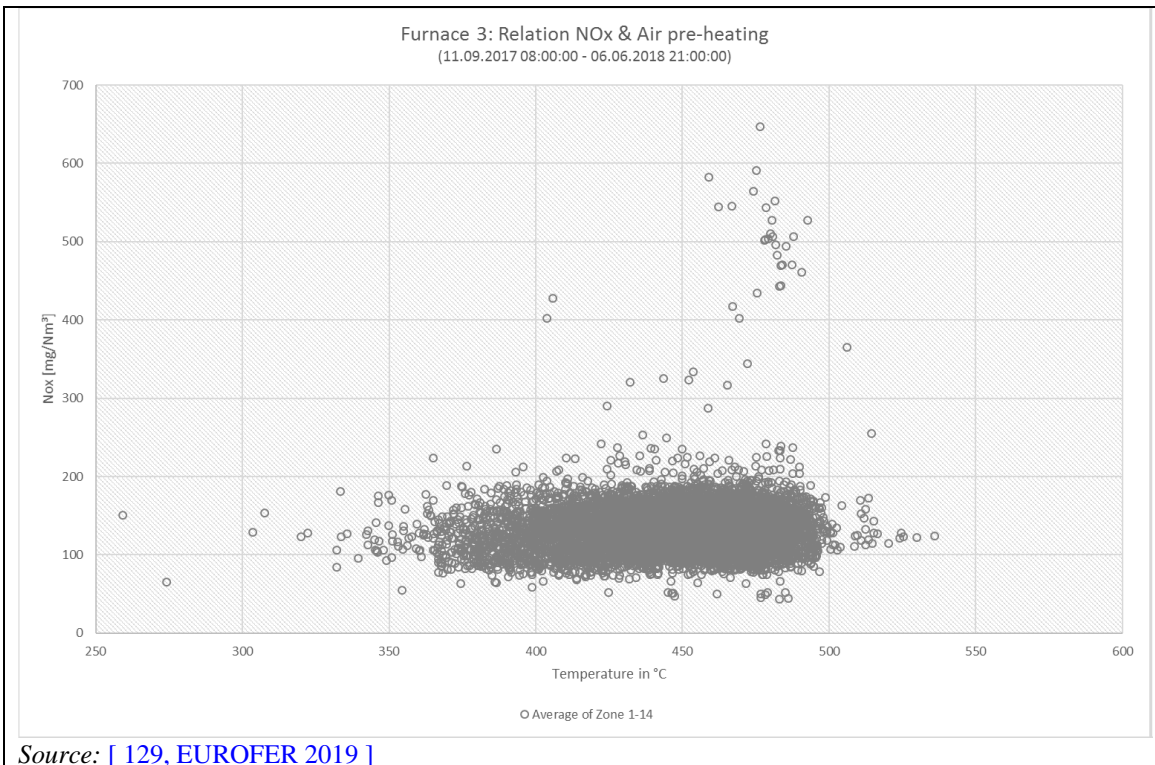
Generally, plant operators are interested in reducing the fuel consumption as this implies a monetary benefit, but the reduction of fuel consumption can additionally reduce other air pollutants, such as CO₂, SO₂ and particulates. Thus a balance may need to be achieved between energy efficiency and decreasing SO₂ and CO₂ emissions on one hand and increasing NO_x emissions on the other. When keeping air preheating temperatures high, the application of secondary NO_x reduction measures might be necessary.

A table is provided in Annex 11.9 which compares the advantages and disadvantages of this technique with other NO_x emission reduction techniques.

Environmental performance and operational data

In the following figures, the NO_x emissions in relation to the air preheating temperature are given for existing furnaces operated in hot rolling mills. It is noted that the figures below reflect the specific circumstances of individual plants and cannot be considered as a general scenario for the relation of NO_x emissions and air preheating temperature.

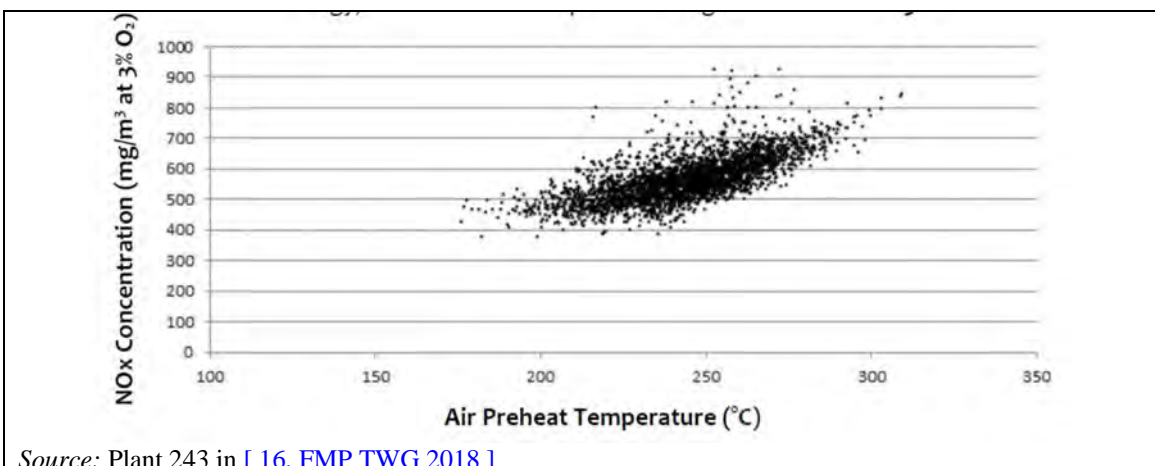
Figure 8.39 shows NO_x emission values in relation to the air preheating temperature for a natural-gas-fired walking beam furnace (Furnace No. 3, ArcelorMittal Bremen (referring to plant/emission point 121 HR-3 in the data collection)). Figure 8.39 does not provide information on the oxygen reference level or the averaging period.



Source: [129, EUROFER 2019]

Figure 8.39: Example of the relation of NO_x and air preheating temperature for a natural-gas-fired walking beam furnace

Figure 8.40 shows the hourly average NO_x emissions values derived from continuous measurement for a pusher-type reheating furnace (furnace No. 2, SSAB Oxelösund - Hot Rolling Mill corresponding to plant/emission point 243 HR-2 in the data collection). Coke oven gas is used as a primary fuel (more than 95 % of the energy input) and heavy fuel oil (HFO) is used as supplementary fuel. For the reporting years 2015 and 2016, the plant reported minimum daily mean values of 309 – 388 mg/Nm³ (COG (%): 69 – 77 %) and maximum daily mean values of 591 – 721 mg/Nm³ at 3% O₂ level (COG (%): 92 – 100%) were reported for the years 2015 and 2016.



Source: Plant 243 in [16, FMP TWG 2018]

Figure 8.40: Example of the relation of NO_x and air preheating temperature for a (mainly) COG-fired reheating furnace

Figure 8.41 shows NO_x emission concentrations obtained from continuous measurement for a heat treatment furnace for plates. The furnace is fired 100 % with COG.

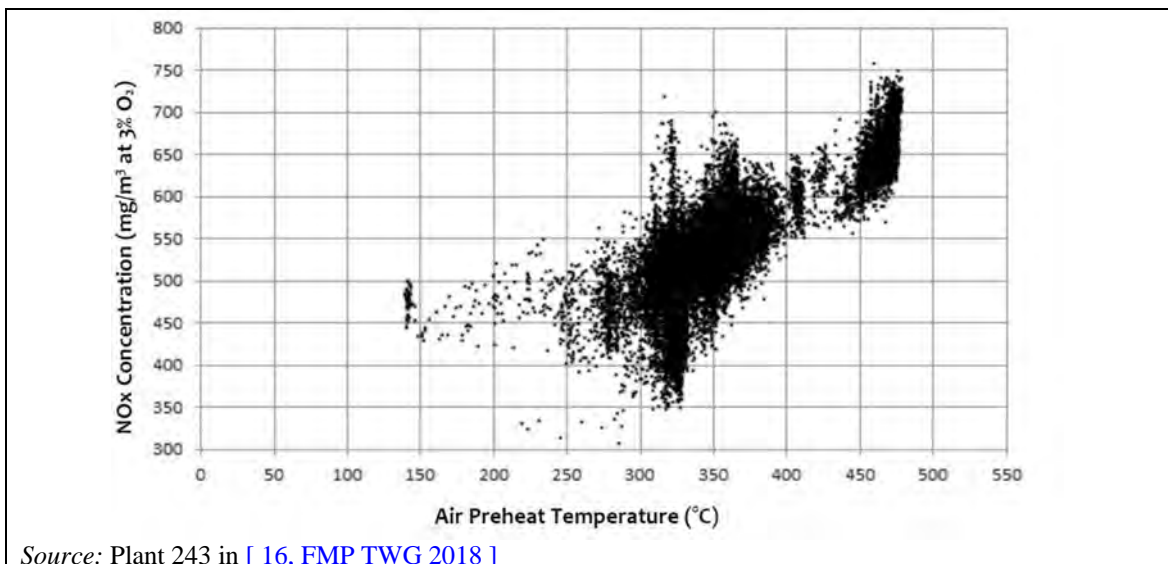


Figure 8.41: Example of the relation of NOX and air preheating temperature for a COG-fired reheating furnace

Cross-media effects

Reduced energy efficiency.

Technical considerations relevant to applicability

May not be applicable in the case of furnaces equipped with radiant tubes burners.

Economics

No information provided.

Driving force for implementation

Environmental legislation.

Example plants

Plants from the data collection: 94 HR4, 242 HR Lines 1 and 2, 243 HR2, 08 CR Lines 4 and 5, 197 CR Lines 1, 2, 3 and 4.

Reference literature

No information provided.

8.8.2.11 Flameless combustion

See Section 2.4.2.6.

8.8.2.12 Oxy-fuel combustion

See Section 2.4.2.5.

8.8.2.13 Selective catalytic reduction (SCR)

More information on the technique

See Section 8.8.1.4.

8.8.2.14 Selective non-catalytic reduction (SNCR)

More information on the technique

See Section 8.8.1.5.

8.8.3 Emissions to air from degreasing

8.8.3.1 Closed degreasing tanks combined with air extraction in the case of continuous degreasing

Description

In the case of cold rolling and hot dip coating of sheets (continuous degreasing), degreasing is carried out in closed degreasing tanks and air are extracted. Emissions are treated by using wet scrubbing and/or a demister.

Technical description

In cold rolling and hot dip coating of sheets, degreasing takes place in closed tanks and fumes are extracted.

The extracted air is then cleaned by means of wet scrubbing or a demister. For the latter, the separation is based on mass inertia. Particles (liquids or solids) with a certain mass and speed follow their original direction. When they collide with obstacles, because of their mass inertia they are separated from the carrier gas stream. Obstacles are created by means of simple walls, fillings (i.e. mesh wire) or labyrinths. [[127, Continuous Coating Shadow Group 1999](#)]

See Sections 8.8.1.1 and 8.8.1.7 for the descriptions of the demister and wet scrubbing techniques, respectively.

Achieved environmental benefits

- Reduction of fugitive emissions.
- Reduction of degreasing fume emissions.

Environmental performance and operational data

A total of 5 m³/h of recirculated water (evaporate) is needed for a production yield of 66 t/h. [[127, Continuous Coating Shadow Group 1999](#)]

Cross-media effects

- Scrubber: water consumption (evaporation) and sludge generation in water treatment plant. [[127, Continuous Coating Shadow Group 1999](#)]
- Demister: depending on the cleaning technique used, treatment of spraying water or solvents. [[127, Continuous Coating Shadow Group 1999](#)]

Technical considerations relevant to applicability

Generally, there are no technical restrictions to the applicability of this technique.

Economics

No information provided.

Driving force for implementation

Environmental legislation.

Example plants

- Hot dip coating (alkaline degreasing): 08 HDC, 40 HDC, 179 HDC, 193 HDC, 194 HDC, 195 HDC.
- Degreasing operations before bright annealing in cold rolling: 88 CR, 144 CR, 246 CR1.
- Degreasing operations before continuous annealing in cold rolling: 94 CR, 98 CR, 179 CR, 244 CR.

Reference literature

[25, EUROFER 2018], [127, Continuous Coating Shadow Group 1999].

8.8.3.2 Emissions to air from degreasing operations in batch galvanising**Description**

In batch galvanising, degreasing is carried out using alkaline or acidic water-based solutions at ambient or moderately elevated temperatures. Under such conditions, extraction may be carried out to remove water vapour from the workplace area but abatement of emissions is not necessary.

Technical description

There are two main degreasing methods in batch galvanising:

- Alkaline degreasing: The concentration, bath temperature and immersion time of the workpieces determine the efficiency of the degreasing baths. The normal temperature range for indirectly heated degreasing baths is 30–70 °C. The bath consists of a sodium hydroxide solution (1–10 %) plus other alkaline reagents, such as soda, sodium silicate, condensed alkaline phosphates and borax, and specific surfactants, emulsifying agents and dispersion agents.
- Acidic degreasing: Degreasing baths consist of diluted strong inorganic acids, such as hydrochloric acid and/or phosphoric acid with additives. Generally, this is carried out at ambient temperature.

The emissions from degreasing baths in batch galvanising are extremely low considering that water-based solutions are used with relatively low operating temperatures. Accordingly, extraction may be carried out to remove water vapour from the workplace area but abatement of emissions is not necessary.

Achieved environmental benefits

Control of water vapour in the workplace area in the vicinity of degreasing tanks.

Environmental performance and operational data

In the FMP data collection, a majority of plants used alkaline degreasing, however a limited number of plants also used acidic degreasing. For acidic degreasing, the temperatures reported were low (e.g. ambient temperature to about 35 °C). For alkaline degreasing, the temperature of the degreasing baths ranged from 25 °C to 65 °C, however most plants operated below 50 °C. No plants in the data collection reported abatement and extraction to control emissions, except of course the plants equipped with enclosed pre-treatment where both pickling and degreasing operations are enclosed. [16, FMP TWG 2018]

Results from emission measurements at batch galvanising plants: [190, EGGA 2020]

During the information exchange, the results of emission measurements (NaOH emissions) were reported for 3 batch galvanising plants that used open degreasing tanks and where an extraction system was used to remove water vapour from the workspace area. In some cases, it was necessary to add a sampling point to realise those measurements since these emissions are not normally monitored.

- Plant 283 (Coatinc Alblasserdam B.V.): Alkaline degreasing at 50 °C, NaOH emission concentrations ranged from 0.4 to 0.7 mg/Nm³ and the corresponding mass flows ranged from 0.004 to 0.006 kg/h.
- Plant 285 (Coatinc Mook B.V.): Alkaline degreasing at 50 °C, NaOH emission concentrations ranged from 0.96 to 1.65 mg/Nm³ and the corresponding mass flows ranged from 0.035 to 0.056 kg/h.
- Plant 71 (Galvanizadora Valenciana S.L.U.): Alkaline/acidic degreasing at 60 °C, NaOH emission concentrations ranged from 0.17 to 0.46 mg/Nm³ and the corresponding mass flows ranged from 0.008 to 0.026 kg/h.

Results from worker exposure monitoring programmes at batch galvanising plants: [190, EGGA 2020]

During the information exchange, the results of stationary workplace air measurements (for NaOH and phosphorus) were reported for several batch galvanising plants using open degreasing baths.

- Plant 20 (Galvapower Group Houthalen): Alkaline degreasing at 52.5 °C using NaOH solutions at 8.3 g/L, NaOH concentrations were below 0.087 mg /Nm³ in all the workplace locations tested (e.g. near the degreasing tanks).
- National workplace exposure monitoring programme in Germany (2018): An extensive study was carried out at several galvanising plants including checking worker exposures to NaOH and phosphorus in the vicinity of alkaline and acidic degreasing baths. Both stationary and personal sampling were carried out. In all sampling campaigns, the measured workplace air concentrations were below the limit of detection for both NaOH and phosphorus. For NaOH, 11 personal measurements were carried out at 11 BG plants and all the samples were below the limit of detection (0.04 mg / Nm³). In total, 9 stationary measurementst were also carried out and all the samples were also below the limit of detection. For phosphorus, 8 personal measurements and 8 static measurements were carried out at 8 BG plants and all the samples were below the limit of detection (0.01 mg / Nm³).

Cross-media effects

None reported

Technical considerations relevant to applicability

Generally, there are no technical restrictions to the applicability of this technique.

Economics

No information provided.

Driving force for implementation

Workplace exposure.

Example plants

Plants from the data collection: 71, 283, 285.

Reference literature

[16, FMP TWG 2018], [190, EGGA 2020].

8.8.4 Emissions to air from pickling in HR, CR, HDC and WD

8.8.4.1 Batch pickling in tanks equipped with lids or enclosing hoods combined with fume extraction

Description

Batch pickling is carried out in tanks equipped with lids or enclosing hoods that can be opened to allow charging of the wire rod coils. The fumes from the pickling tanks are extracted.

The captured emissions are then extracted and treated by wet scrubbing followed by a demister (see Section 8.8.4.3).

Technical description

Emissions to air from pickling lines with high acid concentrations and high temperatures are dangerous for the health of the operators and can cause corrosion to nearby installations and equipment such as building and cranes. Emissions are captured, collected and treated to protect the environment and reduce workers' exposure. Pickling of wire rod coils where the hot rolling oxides are removed using high acid concentration and process temperatures (e.g. > 60 °C) will

generate high concentrated acid emissions that need to be collected and treated. [25, EUROFER 2018]

To minimise acid emissions, batch pickling takes place in tanks equipped with lids or enclosing hoods to collect the emissions. The fumes from the pickling tanks are extracted and treated using wet scrubbing followed by a demister.

Achieved environmental benefits

Reduction of dust, acids (HCl, HF, H₂SO₄) and SO₂ emissions.

Environmental performance and operational data information

HCl pickling

Plant 97 HR reported HCl emission concentrations ranging from 0.14 mg/Nm³ to 6.8 mg/Nm³ with a mean value of 2.3 mg/Nm³, over the 3-year monitoring period of the FMP data collection. For this plant, the temperature of the acid bath was 85°C and the average exhaust flow rate was 15 770 Nm³/h. [16, FMP TWG 2018]

HF/HNO₃ pickling

Table 8.11 summarises the HF emissions of batch pickling plants included in the FMP data collection. For these plants, the temperature of the acid bath ranged from 25°C to 60°C and the exhaust flow rate ranged from 12 089 Nm³/h to 44 351 Nm³/h.

Table 8.11: HF emission concentrations from batch pickling

Substance	Concentrations reported over 3-year period - (mg/Nm ³)					Number of plants / number of measurements
	Average	Median	90 th percentile	Min.	Max.	
HF	0.26	0.12	0.72	0.04	0.93	4 / 24

Source: [16, FMP TWG 2018]

Cross-media effects

None.

Technical considerations relevant to applicability

Generally, there are no technical restrictions to the applicability of this technique.

Economics

No information provided.

Driving force for implementation

Environmental legislation.

Example plants

HCl pickling: 97 HR.

HF/HNO₃ pickling: 19 HR1, 175 HR1, 177 HR1, 2 and 3, 266 HR1 and 2.

Reference literature

[25, EUROFER 2018], [158, Stone 1997].

8.8.4.2 Continuous pickling in closed tanks combined with fume extraction

Description

Continuous pickling is carried out in closed tanks with limited entry and exit openings for the steel strips, sheets or wire. The fumes from the pickling tanks are extracted. They are treated using wet scrubbing followed by a demister.

Technical description

Completely closed/sealed tanks where the material enters the pickling tank through small openings are used in continuous processes to pickle hot strips and wires. This is the most effective way to capture the emissions from pickling in completely closed/sealed tanks as shown in Figure 8.42. The material enters the pickling tank through small openings. The whole process section including the rinse section is kept under slight negative pressure to avoid the escape of fumes. The collected emissions/vapours are treated using wet scrubber systems followed by a demister. [25, EUROFER 2018]

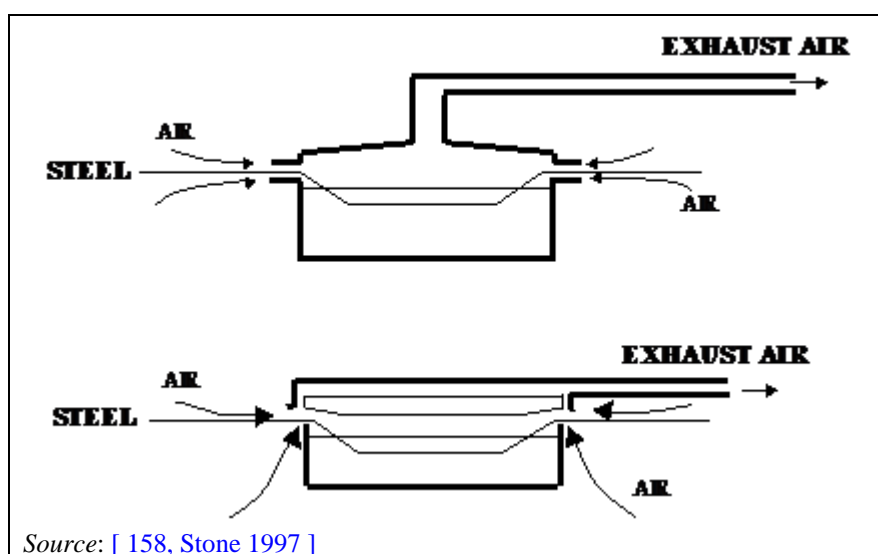


Figure 8.42: Design principles for closed pickling tanks

Achieved environmental benefits

Reduction of dust, acids (HCl, HF, H₂SO₄) and SO₂ emissions.

Environmental performance and operational data information

HCl pickling

Table 8.12 summarises the HCl emissions of continuous pickling plants with closed pickling tanks included in the FMP data collection. For these plants, the temperature of the acid bath ranged from 70°C to 87°C and the exhaust flow rate ranged from 7 658 Nm³/h to 42 909 Nm³/h.

Table 8.12: HCl emission concentrations from continuous pickling

Substance	Concentrations reported over 3-year period - (mg/Nm ³)					Number of plants / number of measurements
	Average	Median	90 th percentile	Min.	Max.	
HCl	3.3	1.3	6.2	0.3	27.8	5 / 37

Source: [16, FMP TWG 2018]

HF/HNO₃ pickling

Plant 88 HR1 reported HF emission concentrations ranging from 0.06 mg/Nm³ to 3.12 mg/Nm³ with a mean value of 1 mg/Nm³, over the 3-year monitoring period of the FMP data collection. For this plant, the temperature of the acid bath was 55°C and the average exhaust flow rate was 2 191 Nm³/h. [16, FMP TWG 2018]

Cross-media effects

None.

Technical considerations relevant to applicability

Generally, there are no technical restrictions to the applicability of this technique.

Economics

No information provided.

Driving force for implementation

Environmental legislation.

Example plants

HCl pickling: 130 CR1, 159 CR1, 209 CR1, 269 HR1, 249 CR2 and 4.

HF/HNO₃ pickling: 88 HR1.

Reference literature

[16, FMP TWG 2018], [25, EUROFER 2018].

8.8.4.3 Wet scrubbing followed by a demister**Description**

See Sections 8.8.1.7 and 8.8.1.1.

Technical description

Wet scrubbing systems are used to remove acid gas, aerosols or vapour from waste gases. The principle of wet scrubbing is absorption of gas or liquid in the scrubbing medium by close gas-liquid contact. Absorption systems can have either aqueous or non-aqueous liquid phases. The selection of the appropriate reagents depends upon the properties of the pollutant to be removed from the gas stream. Water is suitable for absorbing soluble acidic gases such as hydrogen chloride and hydrogen fluoride and also for absorbing ammonia. Alkaline solutions are suitable for absorbing less soluble acidic gases such as sulphur dioxide, hydrogen sulphide and chlorine. [191, Stone 1998]

The gas absorber needs a liquid/gas interface of high surface area across which mass transfer can occur. This is usually achieved using packing materials which are coated with liquid or by droplet/bubble formation. The absorber design also has to provide a means for renewing the liquid absorbent so that a high driving force for mass transfer is maintained. Gas absorption is a rate process and consequently the concentration gradient (driving force for the reaction) and the surface area of contact between the liquid and gaseous phase are crucial design parameters. The surface area is determined by the packing material or droplet size. Gas and liquid flow rates and pressure drop across the absorber influence the driving force, the efficiency and, in some cases, the surface area (droplet formation). In the following sections the principal wet scrubbing systems used in connection with scrubbing of waste gas from acid pickling are described.

Packed scrubbers (Figure 8.43) consist of an outer shell containing a bed of packing material on support grids, liquid distributors, gas and liquid inlets and outlets, and a mist eliminator.

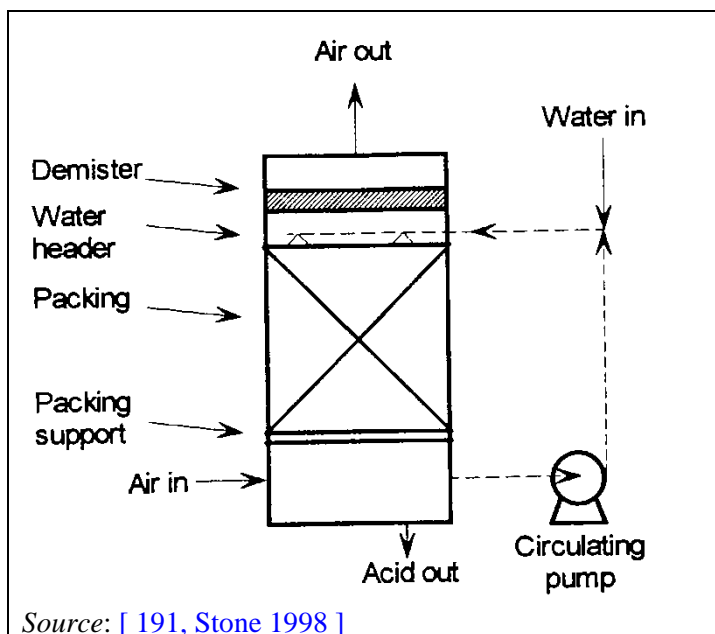


Figure 8.43: Principle of packed scrubbers

The water is usually delivered to the top of the packing bed, and runs down, by gravity, flowing over the packing, while the waste gas enters the bottom of the scrubber, and is washed by the water as it passes upwards through the bed. With this countercurrent flow design, the most contaminated gas contacts the most contaminated water at the bottom of the scrubber, and the cleanest gas contacts the cleanest water at the top of the scrubber. Other designs are possible in which the liquid and gas flows may be cocurrent or cross-current. [191, Stone 1998]

To get an even flow and good contacting of air and water, the water has to be distributed evenly over the top of the packing bed. This is usually done by a distribution header, equipped with spray nozzles. In addition, to ensure that the gas can flow through the whole bed, the packing is held up by a packing support. This packing support has to be open enough to allow the water and air to pass through without creating too much pressure drop, while still being strong enough to hold the packing up, even when it is dirty, and flooded with water. [191, Stone 1998]

A disadvantage of packed scrubbers is that, in order to function properly, the packing needs a relatively high water flow rate - about 200 gpm of water for 20 000 cfm of air (equals 1.34 l/m³). So, instead of using fresh water, most packed scrubbers have recirculation pumps, which pump the water from the bottom of the scrubber to the top of the packing. A small, continuous flow of water has to be added to the scrubber to purge the acid removed from the gas stream, through the overflow. The disadvantages of this practice are: [191, Stone 1998]

- the pump requires maintenance;
- the water at the top of the packing is now contaminated, so the advantages of countercurrent flow are no longer obtained;
- any dirt in the water is pumped back into the packing, where it may separate and block the distribution header or the packing. [191, Stone 1998].

Still, in comparison to plate scrubbers, packed scrubbers allow processing of high volume at a good rate. [25, EUROFER 2018]

Higher scrubbing efficiency can be obtained in packed scrubbers by increasing the depth of the packing bed. [191, Stone 1998]

The advantages of packed scrubbers are:

- simple construction;
- the ability to operate over a wide range of gas flow rates. [25, EUROFER 2018]

However, to keep a packed scrubber running at the most efficient level requires a significant maintenance effort to keep the circulating pump going, ensuring that the water distribution on to the packing is consistent, and keeping the packing clean. The conventional packed scrubber is a vertical tower, with the air flowing up, and the water running down. A variation on this is the **cross-flow scrubber** (Figure 8.44). In a cross-flow scrubber, the waste gas flows horizontally through the packing, while the liquid still flows down, across the flow of the waste gas. The basic set-up is the same as for conventional packed scrubbers, and a circulating pump is still needed to keep the packing wet. [191, Stone 1998]

The advantage of the cross-flow scrubber is that it needs less head room, and the ducting is usually simpler and less expensive than for a vertical scrubber. However, cross-flow scrubbers are slightly less efficient than vertical counterflow at removing soluble gases. An advanced type of cross-flow scrubber emulates the multi-stage scrubbing of a plate scrubber. In this version there are several packed beds in series. Each bed has a separate water supply, or circulation system, and may use a structured packing, rather than a random one. This advanced type of scrubber has quite a high pressure drop, and is not currently used in pickling applications. Random packed cross-flow units are widely used. [191, Stone 1998]

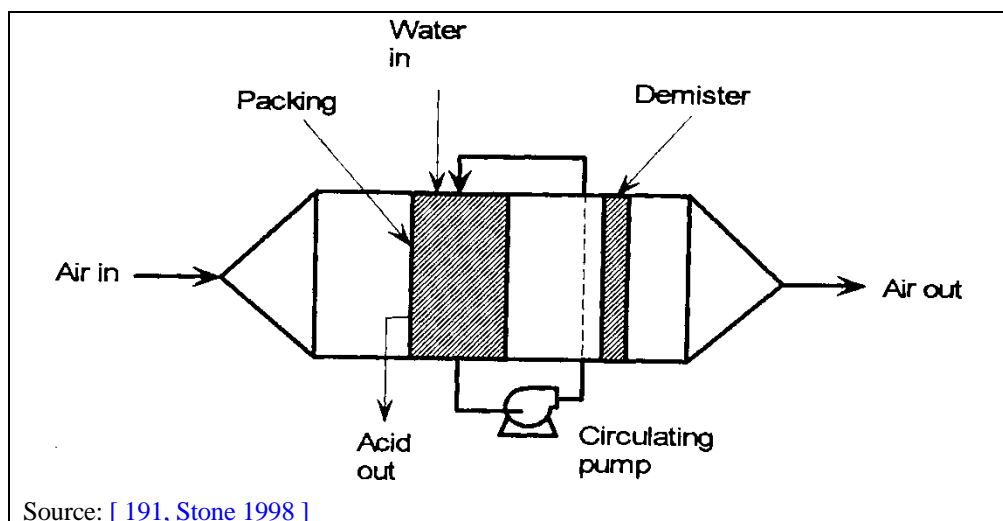


Figure 8.44: Principle of a cross-flow scrubber

Plate scrubbers (Figure 8.45) consist of a vertical tower with several horizontal perforated trays (sieve plates) stacked in it. Baffles are situated a short distance above the apertures in the plates. Scrubbing liquid enters the top of the tower and flows along each of the trays successively. The waste gas enters the bottom of the tower and flows upwards, passing through the perforations in the plates. The velocity of the gas is sufficient to prevent liquid seeping through the perforations. [191, Stone 1998]

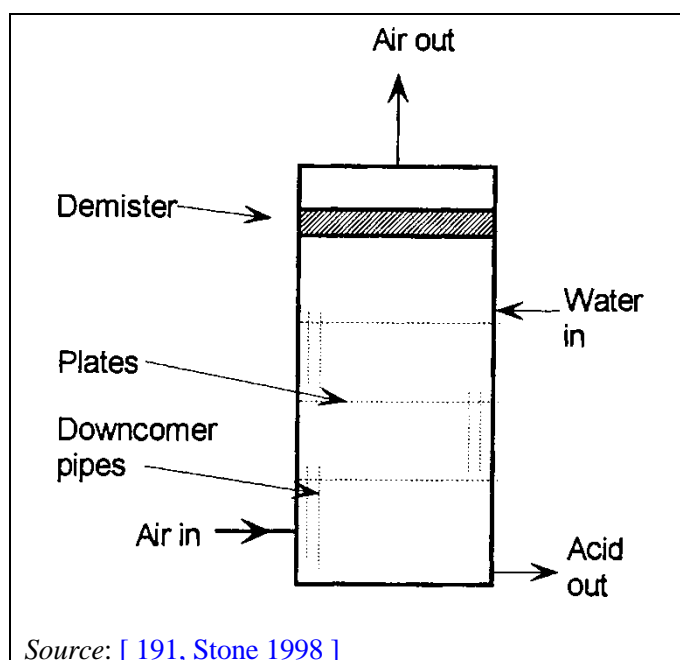


Figure 8.45: Principle of plate scrubbers

The absorption efficiency can be increased by adding more plates to the absorber (increasing the tower height) and by increasing the liquid flow rate. [191, Stone 1998]

Because the water forms a pool on each plate, smaller water flow rates are sufficient for the exchange of substances. A constant flow is necessary to flush out dissolved fumes, and also to offset weeping that occurs through the holes, due to surface tension effects. In general, recirculation pumps are unnecessary on plate scrubbers, and these scrubbers operate in true countercurrent flow. [25, EUROFER 2018], [191, Stone 1998]

Plate scrubbers are simple and have no moving parts, but require careful installation, to ensure the plates are level, and steady air flow. [191, Stone 1998] They can be susceptible to plugging and scaling, and are not suitable for foaming liquids. [191, Stone 1998]

The plate scrubber advantages are its low maintenance requirements, and once-through flow of water, which is useful in making high-strength solutions suitable for recycling into the pickling tank. However, a plate scrubber needs careful installation (to level the plates), and has a limited range of air flow variation. [191, Stone 1998]

All that is needed to keep a plate scrubber operating at design efficiency is the proper flow rate of water to the top tray, and an air flow rate within the designed range. Reported water consumption levels ranged from 0.06 l/m³ to 0.13 l/m³. [191, Stone 1998]

A key element of scrubbers - as shown above - is the **demister** (entrainment separator, droplet separator, mist eliminator). This is a device that ensures that the air leaving the scrubber is free of water droplets. [191, Stone 1998]

The principle of all demisters is the same. The inertia of fluid droplets allows the separation from the carrier gas stream by guiding the loaded air through a channel or maze with several changes of direction. The water droplets are forced to impact on a solid surface, where they create larger drops, which are too heavy to be carried by the air. [25, EUROFER 2018], [191, Stone 1998]

There are two main types of demister: *knitted mesh* and *chevron baffles*.

The knitted mesh type is simple to handle and install, and separates the water by agglomerating it on fine plastic fibres. Its disadvantages are that it also tends to remove dust, besides water, and the fine plastic fibres deteriorate in time. Eventually, after 3 to 5 years, the accumulated dust and fibre debris plug up the demister, and it has to be replaced. [191, Stone 1998]

The chevron type of demister consists of a bank of parallel, S-shaped blades, through which the gas passes - the water is removed by impact on the blade surface. This type of demister is not susceptible to plugging, and has an almost unlimited lifetime. [191, Stone 1998]

Both types of demister will remove over 99.99 % of the droplets created in wet scrubbers. [191, Stone 1998]

In a **fume filter** (Figure 8.46), the air passes at low velocity through a compacted fibrous bed. As it flows through, the droplets impact on the fibres, agglomerate, and eventually become large enough to drain away by gravity. As this kind of filter also removes dust from the air, it requires washing at regular intervals for cleaning. However, while packed and plate scrubbers usually use several gpm of water on a continuous basis, the filter only uses 30–50 gal/day (114–190 l/d) for rinsing, and this water can be returned to the pickling tank ('no-effluent' scrubber). [191, Stone 1998]

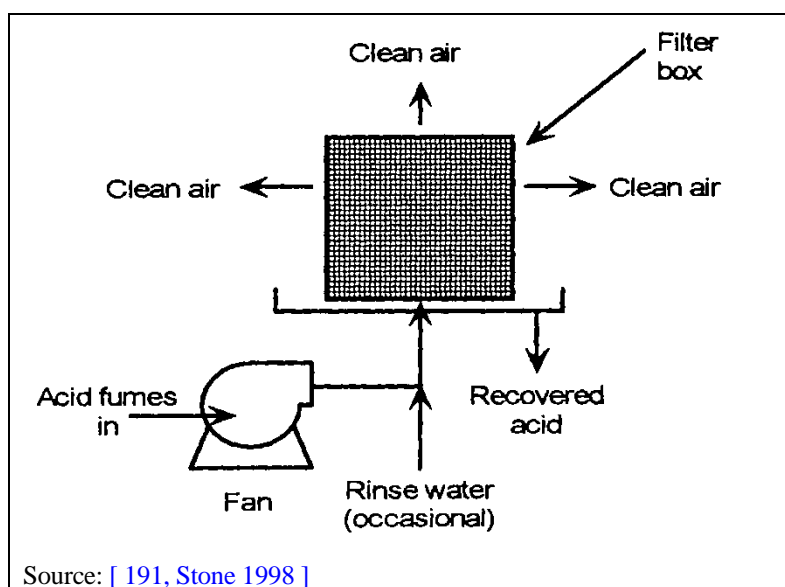


Figure 8.46: Principle of fume filter

Technical aspects specific to mixed acid pickling

Stainless steel is pickled in a mixture of nitric and hydrofluoric acid. Nitric acid is a low-boiling liquid whereas hydrogen fluoride (HF) is a gas, like HCl. As a result, these pickling tanks emit vapours. In addition, they produce droplets which are generated by the bursting of nitrogen oxide (NO_x) bubbles. However, in the case of mixed acid pickling, these droplets are not as fine as sulphuric acid droplets observed in steel pickling, and are less problematic to collect. [191, Stone 1998]

The nitric and HF vapours and droplets are easily removed in a packed or plate scrubber, using a small throughput of water. [191, Stone 1998] However, if aerosols are present, the operation of an intensive spraying zone may be required for an efficient aerosol precipitation. [10, Rentz et al. 1998]

The NO_x gases are not easily removed because they are not very soluble in water (refer to Sections 8.8.5 for NO_x abatement). [191, Stone 1998]

A problem that can occur in HF scrubbers is scaling, caused by the deposit of insoluble calcium fluoride. This is produced by the reaction of hard (calcium-bearing) water with the hydrofluoric acid, and can plug up the packing, the outlet pipes, downcomers or recirculation piping. The best way to avoid this problem is to install a water softener to remove the calcium from the supply to the scrubber. [[191, Stone 1998](#)]

Achieved environmental benefits

Reduction of dust, acids (HCl, HF, H₂SO₄) and SO₂ emissions.

Environmental performance and operational data information

Table 8.13 summarises the emissions of dust, HCl, HF (mixed acid plants) and SO_x for CR, HR or HDC pickling plants in the FMP data collection.

Table 8.13: Emissions of dust, HCL, HF and SOx from pickling plants equipped with acid gas abatement systems (wet scrubber / demister)

Substance	Concentrations reported over 3-year period - (mg/Nm ³)				Type of process / Type of tank	Reference plants
	Average	Median	Min.	Max.		
Dust	2.4	1.9	0.6	7.0	Batch / Turbulence and deep type tanks	19 HR 97 HR 239 HR
HCl	1.7	1.1	0.4	6.8	Batch / Turbulence and deep type tanks	19 HR 97 HR
HF	0.14	0.06	0.02	0.93	Batch / Shallow and deep type tanks	19 HR 175 HR 177 HR 266 HR
SO _x	0.9	0.3	0.1	2.3	Batch / Deep type tanks	175 HR
Dust	2.6	2.1	0.5	6.4	Continuous / Turbulence and deep type tanks	90 HR 41 HDC
HCl	6.0	1.9	0.9	78.0	Continuous / Turbulence and deep type tanks	195 CR 159 CR 249 CR 94 CR 41 HDC
HF	0.25	0.11	0.03	3.1	Continuous / Turbulence and deep type tanks	246 CR 144 CR 88 HR
Dust	2.0	-	-	-	Coupled pickling and rolling / Shallow type tanks	119 CR
HCl	2.6	1.6	0.1	15.7	Coupled pickling and rolling / Turbulence, shallow and deep-type tanks	194 CR 102 CR 130 CR 122 CR
Dust	4.5	3.5	0.7	18.0	Push pull / Shallow and deep type tanks	105 CR 225 CR
HCl	2.5	2.1	2.0	7.6	Push pull / Turbulence, shallow and deep-type tanks	225 CR 115 CR
HF	0.25	0.22	0.10	0.35	Push pull / deep type tanks	105 CR

Source: [16, FMP TWG 2018]

Table 8.14 summarises the emissions of HCl from wire drawing plants (pickling of wire rods) from the FMP data collection.

Table 8.14: Emissions from wire drawing plants (i.e. pickling of wire rods using HCl) equipped with acid gas abatement systems (wet scrubber / demister)

Substance	Concentrations reported over 3-year period - (mg/Nm ³)					Number of plants / number of measurements
	Average	Median	90 th percentile	Min.	Max.	
HCl	3.2	1.2	8.0	0.5	8.9	23 / 35
<i>Source:</i> [16, FMP TWG 2018]						

Cross-media effects

- Increased energy consumption.
- Generation of acidic waste water, which can be reused in the process, e.g. as rinse water for HCl regeneration, or require neutralisation followed by water treatment (associated with consumption of chemicals and generation of water treatment sludges), or has to be disposed of externally. [25, EUROFER 2018]

Technical consideration relevant to applicability

Generally, there are no technical restrictions to the applicability of this technique.

Economics

Table 8.15: Estimated costs for countercurrent water scrubbing in packed columns

Countercurrent water scrubbing in packed columns		
Production capacity	900000	t/a
Energy consumption (electrical)	0.68	kWh/t
Volume flow	10.6	Nm ³ /s
Investment cost	625 000	EUR
Operating costs	14 000	EUR
<i>Source:</i> [18, CITEPA 1994]		

Driving force for implementation

- Collection / treatment of acidic vapour fumes from pickling tanks. [25, EUROFER 2018]
- Reduction of the potential exposure of workers to acidic fumes in the workplace. [25, EUROFER 2018]

Example plants

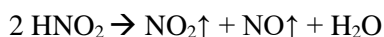
See example plants shown in Table 8.13.

Reference literature

[25, EUROFER 2018], [191, Stone 1998], [192, EPA 1998].

8.8.5 NO_x reduction techniques in mixed acid pickling

When stainless steel is pickled in mixed acid, the nitric acid reacts with the metal or metal oxides and is reduced to nitrous acid (HNO₂), which is, in turn, in equilibrium with a mixture of nitrogen oxides.



In the case of batch pickling operations (e.g. for stainless steel tube), pickling is carried out at ambient temperature. Batch processes usually apply open tanks, where a lower temperature and longer pickling times (e.g. 60–90 minutes) reduce the rate of NO_x emissions.

Coil, sheet or wire pickling, if carried out continuously, requires higher acid temperatures in order to maintain an effective pickling result in short pickling times (i.e. usually 2–4 minutes).

Since higher acid temperatures generate higher emissions of NO_x, closed tanks are installed. Specific techniques employed for NO_x suppression and reduction are described in the following sections.

8.8.5.1 Nitric-acid free pickling of high-alloy steel

Description

Pickling of high-alloy steel is carried out by fully substituting nitric acid with a strong oxidising agent (e.g. hydrogen peroxide).

Technical description

In mixed acid pickling of high-alloy steel, nitric acid acts both as an acid and an oxidant in the pickling process. Theoretically, the replacement of the acid contribution by another acid, for example sulphuric acid, and the oxidant contribution with hydrogen peroxide shall result in a nitric-acid-free metal pickling solution.

Trials have been carried out at various steel mills in Europe where this technology has been successfully used for stainless steel pickling techniques. [[193, Sanders 1997](#)]

These processes rely on the oxidising nature of the ferric ion; the ferric ion content of the pickling liquor is maintained at a minimum concentration of 15 g/l. This is achieved by the introduction of an oxidising agent to oxidise the ferrous iron (Fe²⁺) formed during the pickling reaction to ferric iron (Fe³⁺).

The oxidising agent chosen is normally hydrogen peroxide, as this does not introduce any foreign ions into the pickling bath and the method of addition is essentially the same as that used in other NO_x suppression techniques. This treatment can be used at all types of production facilities, i.e. continuous or batch pickling. [[193, Sanders 1997](#)]

The actions of HF/H₂O₂ mixtures on high-alloy steel are considerably less aggressive than that of HF/HNO₃ at high pickling temperatures (around 50–60 °C), although the reverse of this has been shown when pickling has been carried out at ambient temperatures of approximately 20–25 °C. [[193, Sanders 1997](#)]

Additives, such as nonionic surfactants and corrosion accelerators, are also added to the pickling bath, to maintain pickling efficiency. Stabilisers are added, to prolong the lifetime of the hydrogen peroxide in the pickling bath. [[193, Sanders 1997](#)]

Achieved environmental benefits

Reduction of NO emissions.

Environmental performance and operational data

Pilot trials which have been carried out have shown that the nitric-acid-free pickling process has a number of advantages when compared with the conventional nitric acid/hydrofluoric acid process. [[193, Sanders 1997](#)]

The reported advantages of hydrogen-peroxide-based nitric-acid-free pickling are:

- in certain cases, shorter pickling times;
- reduced sludge formation;
- longer bath life;
- greatly reduced intergranular corrosion;
- less aggressive pickling resulting in reduced attack on the metal surface and reduced weight loss of steel;
- reduced NO_x emissions and nitrate effluent discharges (in fact, there is an overall reduction in the volume of effluent per tonne of product per bath);
- all effluents can be precipitated by lime treatment;
- no major modifications are required to use the process at existing pickling plants; with no major equipment required except for a simple control system;
- there is a reduction in product dissolution and potential for an improvement in product quality.

The emission concentrations of NO_x reported by several plants in the FMP data collection are summarised below:

- Plant 175 HR1: Batch pickling plant using deep-type tanks for stainless steel production with mixed acid – Average NO_x emissions over 3-year period of 1.5 mg /Nm³. [[16, FMP TWG 2018](#)]
- Plant 90 HR Lines 3 and 4: Continuous pickling plants using turbulence tanks for stainless steel production with mixed acid – Average NO_x emissions over 3-year period of 23.9 mg/Nm³. [[16, FMP TWG 2018](#)]

Cross-media effects

None identified.

Technical considerations relevant to applicability

Only applicable to new plants and major plant upgrades.

Economics

The hydrogen-peroxide-based nitric-acid-free pickling process can operate effectively at low temperatures, therefore saving on heating costs compared with the conventional nitric acid/hydrofluoric acid process, which is usually required to operate at approximately 60 °C to be effective. [[193, Sanders 1997](#)]

Driving force for implementation

Environmental legislation.

Example plants

Plants from the data collection: 90 HR3, 90 HR4, 175 HR1.

Reference literature

[[93, Cold Rolling Shadow Group 2000](#)], [[193, Sanders 1997](#)].

8.8.5.2 Addition of hydrogen peroxide or urea to the pickling acid

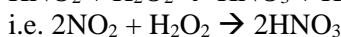
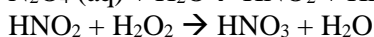
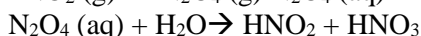
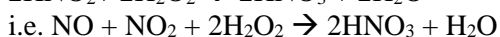
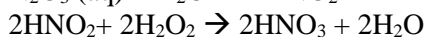
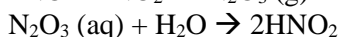
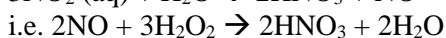
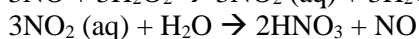
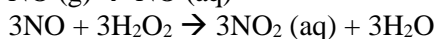
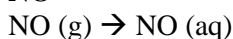
Description

Hydrogen peroxide or urea is added directly to the pickling acid to reduce the generation of NO_x emissions.

Technical description

Hydrogen peroxide or urea is added directly to the pickling acid to reduce the generation of NO_x emissions or is added to the scrubbing solution. When using hydrogen peroxide, the nitric acid formed can be recycled to the pickling tanks.

The reaction between hydrogen peroxide (H₂O₂) and NO_x occurs in the aqueous phase, in which NO_x reacts with water to form nitrous acid (HNO₂). The HNO₂ is relatively unstable and will readily decompose back to NO₂, NO and H₂O. The NO_x would ultimately be emitted from the process. However, the presence of H₂O₂ rapidly oxidises HNO₂ to the more stable HNO₃, thus preventing the reformation and emissions of NO_x. This behaviour is detailed in the following chemical reaction equations:

NO₂**NO/NO₂****NO**

The key to the efficient usage of hydrogen peroxide in NO_x suppression, by addition to the pickling bath, lies in effective mixing.

When hydrogen peroxide is added to the pickling liquor containing both oxides of nitrogen and transition metal ions, it will either oxidise the NO_x, according to the chemistry outlined above, or will itself undergo catalytic decomposition by reaction with the metal ions.

NO_x suppression by H₂O₂ injection into a recirculation loop

Austenitic steels are generally endothermic in pickling character, while ferritic steels are exothermic due to the differences in chemical composition. Therefore, some form of temperature control is installed. The normal method is to incorporate a recirculation loop, whereby the bath liquor is recirculated through either a heater or a cooler.

One method for effective mixing of H₂O₂ in the bath liquor is to inject the hydrogen peroxide into the recirculated pickle liquor. The bath contents are pumped around a recirculation loop at a rate of up to ten bath changes per hour. Hydrogen peroxide (35 %) is dosed into this loop at up to 1 litre per minute, dependent upon the process conditions pertaining. A schematic diagram of this operation is shown in Figure 8.47.

Trials carried out have shown that NO_x suppression efficiencies in excess of 90 % have been achieved using this technique.

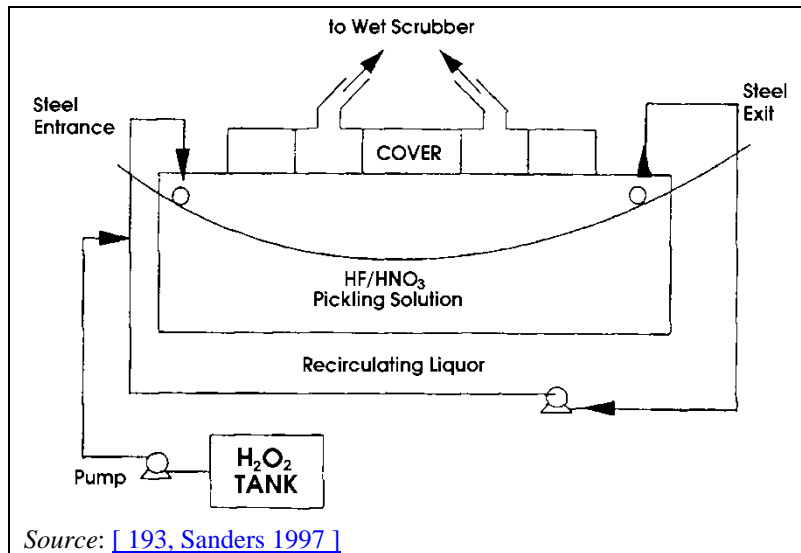


Figure 8.47: Schematic for injecting H_2O_2 into pickling acid recirculation loop

NO_x suppression by H_2O_2 injection into the pickling bath via a sparge pipe

The capital cost of a new installation of a recirculation loop to a pickling bath can be high if a static pickling bath is in operation. Therefore, an alternative method of H_2O_2 addition to the pickling bath is to directly inject H_2O_2 into the pickling bath via a bifurcated sparge located in the pickling bath. A simple sparge pipe, made from 30 mm diameter polypropylene tubing, with 3 mm holes drilled at 150 mm intervals, is inserted into the bath. [193, Sanders 1997]

Due to the large amount of insoluble scale which builds up in the pickling bath, the sparge pipe is arranged with the holes pointing at 45° downwards to the horizontal to minimise blockages. The sparge pipe is positioned at the steel entry end of the bath, just beneath the moving steel sheet, to prevent accidental collision with the sheet and also to use the constant movement of the steel sheet as a method of effectively mixing the H_2O_2 into the pickling bath. A schematic diagram of the sparge pipe system is shown in Figure 8.48.

Trials carried out have shown that NO_x suppression efficiencies in excess of 90 % have been achieved using this technique. [193, Sanders 1997]

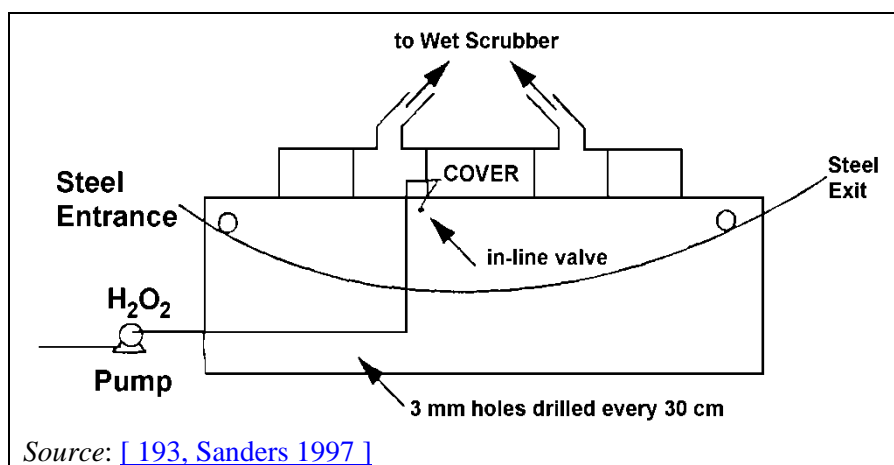


Figure 8.48: Schematic for injecting H_2O_2 into pickling baths via a sparge pipe

NO_x suppression by H₂O₂ injection into a spray pickling facility

An additional example of NO_x suppression using hydrogen peroxide is the one used for pickling of stainless steel plate in a spray chamber. The nitric acid/hydrofluoric acid pickling liquor is sprayed onto both sides of the stainless steel plate; the pickling liquor is then returned from the spray chamber to the pickling holding tank, from where it is recycled to the spray chamber. [193, Sanders 1997]

A pilot trial was carried out at a facility by injecting hydrogen peroxide into the liquor recirculation line immediately before it splits into two branches. It was found that more than 90 % of NO_x emissions were suppressed within ten minutes after introduction of hydrogen peroxide, indicating that the NO_x suppression reaction took place at the site of NO_x generation. [193, Sanders 1997]

Other sources reported NO_x reduction by up to 70 %. [194, UK, EA 1993]

NO_x suppression by hydrogen peroxide has no adverse affect on stainless steel product quality. [193, Sanders 1997]

Advantages of NO_x suppression by hydrogen peroxide

- Hydrogen peroxide converts NO_x to nitric acid *in situ*, and therefore reduces nitric acid consumption, in some cases by 20–30 %.
- No major plant change is required.
- Existing hydrofluoric acid scrubber can be used with no neutralisation of the scrubber liquor required, as the weak hydrofluoric acid solution formed can be returned to the process.

Achieved environmental benefits

Reduction of NO_x.

Environmental performance and operational data

Table 8.16: Achievable emission levels using H₂O₂ injection

	Concentration [mg/Nm ³]	Specific Emission [g/t product]	Reduction rate ¹ [%]	Method of analysis
NO _x	350 - 600	80 - 300	75 - 85	Chemiluminescence
HF	2 - 7	1 - 1.5	70 - 80	Titration

¹ Reduction rate is a combination of H₂O₂ injection and exhaust absorber system.
Source: [89, EUROFER, TG Cold Rolling 1998]

The NO_x emission concentrations reported by plant 266 HR in the FMP data collection are summarised below:

- Plant 266 HR: Batch pickling plant using deep-type tanks for stainless steel production with mixed acid. The process line has four pickling tanks fitted with lips and lids extraction. H₂O₂ is injected into the pickling baths, the fumes are extracted and treated into two nitric acid scrubbers also injected with H₂O. The exhaust gases are subsequently led to another scrubber with NaOH injection. NO_x emissions over 3-year period were within the range 10.3 mg /Nm³ to 169.8 mg /Nm³, with a mean value of 80 mg/Nm³. [16, FMP TWG 2018]

Cross-media effects

- Reduction in acid consumption.
- Consumption of hydrogen peroxide (3–10 kg/t).

Technical considerations relevant to applicability

Generally, there are no technical restrictions to the applicability of this technique.

Economics

For shallow bath turbulent pickling, the required dose rate of hydrogen peroxide may increase dramatically. Hence, for large pickling installations where the dose rate for hydrogen peroxide would be excessive, other NO_x reduction measures, e.g. SCR system, may be more appropriate. [\[93, Cold Rolling Shadow Group 2000 \]](#)

Driving force for implementation

Environmental legislation.

Example plants

Outokumpu Nirosta GmbH, Krefeld, Germany (urea addition) – Plant 144 CR. [\[178, Anstots et al. 1994 \]](#)

Outokumpu Stainless Ltd., Sheffield, UK – Plant 266 HR.

ArcelorMittal Industeel, Le Creusot, France – Plant 175 HR.

Reference literature

[\[18, CITEPA 1994 \]](#), [\[89, EUROFER, TG Cold Rolling 1998 \]](#), [\[93, Cold Rolling Shadow Group 2000 \]](#), [\[178, Anstots et al. 1994 \]](#), [\[193, Sanders 1997 \]](#), [\[194, UK, EA 1993 \]](#).

8.8.5.3 Wet scrubbing with addition of an oxidising agent (e.g. hydrogen peroxide)

Description

An oxidising agent (e.g. hydrogen peroxide) is added to the scrubbing solution to reduce NO_x emissions. When using hydrogen peroxide, the nitric acid formed can be recycled to the pickling tanks.

Technical description

Wet scrubbers are used to abate NO_x fumes from mixed acid pickling. As NO and NO₂ are insoluble or only partially soluble in water, other washing media, such as NaOH, H₂O₂ or urea, are used.

The efficiency of NaOH scrubbers depends on the NO_x concentration and on the NO:NO₂ ratio in the waste gas. To achieve satisfactory reductions, long oxidation times or multi-stage scrubbers are necessary.

To enhance the efficiency of NO_x abatement, two or more packed columns may be installed; one part operated as a reduction column, the other as an oxidation column. The reduction columns are operated countercurrently with NaOH and a reductant: sodium hydrosulphide solution (NaHS). The reductant along with high pH reduces the NO₂ entering the column bottom to nitrogen and washes and neutralises any free acid that may be entrained in the gas stream. Fresh NaOH and NaHS are added to the washing liquid based on pH value and the oxidation reduction chemical potential (ORP). [\[195, Pengidore et al. 1996 \]](#)

The gas stream from the reduction column then enters the oxidation column where NO is oxidised to NO₂. The gas enters the column at the top and flows cocurrently with the oxidising solution (e.g. sodium chlorite - NaClO₂) at low pH. The sodium chlorite forms chlorine dioxide (ClO₂) that oxidises the NO. Fresh acid and NaClO₂ are added based on pH and ORP. The cycle of reduction and oxidation may be repeated to achieve sufficient NO_x abatement rates. [\[195, Pengidore et al. 1996 \]](#)

When H₂O₂ is used for scrubbing, the scrubbing liquor usually consists of a mixture of HNO₃ and H₂O₂ at typical concentrations of 20 wt-% and 0.5 wt-% respectively. A benefit of using H₂O₂ is that the by-product of the scrubbing process is nitric acid, instead of sodium nitrate when using sodium hydroxide. This acid is recovered in usable concentrations and recycled

back to the pickling process. Thus not only is the sodium nitrate waste disposal cost eliminated but the overall nitric acid consumption is reduced. [\[18, CITEPA 1994 \]](#)

Achieved environmental benefits

- Reduction of NO_x.
- Scrubbing with H₂O₂ results in a nitric acid by-product with a concentration that allows recycling to the pickling process.
- Reduction of nitric acid consumption.
- Reduced waste water volume and waste water treatment sludge.
- In the case of H₂O₂ or urea injection in the pickling bath, scrubbing water can be reused as make-up water in the pickling tanks.

Environmental performance and operational data

See the environmental performance of Plant 266 HR (Section 8.8.5.2).

Cross-media effects

Scrubbing with sodium hydroxate results in a sodium nitrate waste which requires disposal.

Technical considerations relevant to applicability

Generally, there are no technical restrictions to the applicability of this technique.

Economics

No information provided.

Driving force for implementation

Environmental legislation.

Example plants

- Outokumpu Nirosta GmbH, Krefeld, Germany– Plant [144 CR]. [\[178, Anstots et al. 1994 \]](#)
- Allegheny Ludlum, USA.
- Acerinox Europa, Spain – Plant [88 CR]. [\[25, EUROFER 2018 \]](#)
- Outokumpu Stainless Ltd., Sheffield, UK – Plant [266 HR].

Reference literature

[\[18, CITEPA 1994 \]](#), [\[25, EUROFER 2018 \]](#), [\[93, Cold Rolling Shadow Group 2000 \]](#), [\[178, Anstots et al. 1994 \]](#), [\[195, Pengidore et al. 1996 \]](#).

8.8.5.4 Selective catalytic reduction (SCR) in mixed acid pickling

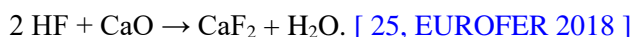
Description

See Section 8.8.1.4.

Technical description

For a full technical description, see Section 8.8.1.4.

More specifically, concerning mixed pickling acid plants, lime treatment can be used in combination with SCR for HF reduction. The gas flow is first heated and inserted into a reactor packed with CaO tiles. Inside the reactor, HF reacts with CaO to form CaF₂ according to the the following equation:



Achieved environmental benefits

- Reduction of NO_x (reduction efficiency of up to 95 % with a typical range of 70–90 %). The achieved NO_x level depends on the initial concentration.
- If coupled with lime treatment, reduction of HF emissions.

Environmental performance and operational data

Table 8.17: NO_x emissions from mixed acid pickling plants employing SCR for emissions control

Substance	Concentrations reported over 3-year period - (mg/Nm ³)					Number of plants / number of measurements
	Average	Median	90 th percentile	Min.	Max.	
NO _x	151	160	240	8	294	4 / 15

Source: [16, FMP TWG 2018]

Cross-media effects

- Energy consumption to heat the exhaust gas to operating temperature for SCR. [25, EUROFER 2018]
- NH₃ consumption in the process. [25, EUROFER 2018]
- New CaO tiles every few years. [25, EUROFER 2018]

Technical considerations relevant to applicability

Applicability to existing plants may be restricted by a lack of space.

Economics

No information provided.

Driving force for implementation

Environmental legislation.

Example plants

- Outokumpu Tornio: Plant 158 CR2.
- Outokumpu Krefeld: Plant 144 CR Lines 1 and 2.
- Avesta Jernverk: Plant 238 CR1.
- Acerinox Europe: Plant 88 CR.

Reference literature

[25, EUROFER 2018].

8.8.5.5 Comparison of NO_x reduction methods for mixed acid pickling

Table 8.18 compares the different NO_x reduction measures and gives an overview of cost.

Table 8.18: Comparison of different NO_x emission reduction measures for mixed acid pickling

	NO _x Suppression by Injection		Nitric Acid-free Stainless Steel Pickling ²	Absorptive Scrubbing		Selective Catalytic Reduction	Selective Non-Catalytic Reduction
	H ₂ O ₂	Urea ¹		NaOH	H ₂ O ₂		
Capital Costs	low	low	NI	high	high	very high	NI
Variable costs	high	low	NI	low	high	low	NI
HNO₃ Consumption	lower	higher	NI	no influence	lower	no influence	NI
NO_x Reduction	very high	very high	NI	low	very high	very high	NI
By-products	recovered	no problem	NI	difficult to discharge	recovered	no problem	NI
Steel Surface Quality	better ³	better ³	NI	no influence	no influence	no influence	NI

Source: [18, CITEPA 1994]

1 Comment: urea injection can lead to ammonia compounds in the effluent [93, Cold Rolling Shadow Group 2000]

2 Comment: only limited application [93, Cold Rolling Shadow Group 2000]

3 Comment: neither urea nor hydrogen peroxide injection give rise to better surface finish [93, Cold Rolling Shadow Group 2000]

NB: NI = No information provided.

8.8.6 Emissions to air from hot dipping

8.8.6.1 Low-fume flux

Description

Ammonium chloride in fluxing agents is partly substituted with other alkali chlorides (e.g. potassium chloride) to reduce dust formation.

Technical description

The 'normal' flux used in batch galvanising consists of a mixture of zinc chloride and ammonium chloride. A 'triple' salt flux contains approximately 45 % zinc chloride and 55 % ammonium chloride. An alternative 'double' salt flux contains approximately 55 % zinc chloride and 45 % ammonium chloride. [[196, EGGA 2019](#)]

When using low-fume flux, the ideal chemical composition is 60% zinc chloride, 30% potassium chloride and 10% ammonium chloride. Keeping this balance in the flux composition is essential to prevent quality problems (e.g. black patches on the workpieces) and minimise dust emissions.

Ammonium chloride is a component of the fluxing agent that has a sublimation temperature below the zinc bath temperature which causes fumes to be generated during hot dipping. To reduce the environmental impact of ammonium chloride during dipping, 'smoke-reducing' fluxing agents in which ammonium chloride has partly or completely been substituted by other alkali chlorides (e.g. potassium chloride) are employed. [[144, ABAG 1993](#)]

When steelwork is dipped into the galvanising bath a fume is given off that can contain total particulate above 50 mg/m³. This fume is usually captured within an enclosure situated over the galvanising bath and extracted to a bag filter. The fume consists mainly of ammonium chloride and, after being extracted through an efficient bag filter, emission levels can be reduced to very low levels. [[196, EGGA 2019](#)]

This technique is not used in hot dip coating of sheets where fluxing is not carried out.

In batch galvanising, this technique cannot be employed in all types of plants. For example, it is not possible to use it in the following applications:

- galvanising of workpieces where product specifications require higher flux concentrations (e.g. 450 g/l) than the flux concentrations typically used in low-fume flux baths (e.g. 120-200 g/l);
- centrifuge spinning galvanising plants;
- any galvanising plant operating with high bath temperature;
- galvanising plants using wet fluxing with a flux blanket where the fluxes are at the surface of the bath.

It is also important to note that the low-fume flux technique requires greater operational care if the workpieces are not completely free of oil and grease. Indeed, even small amounts of oil and grease on the workpieces would cause quality issues on the workpiece (i.e. black patches) using a low fume flux solution whereas residual oil and grease would be burnt off without leaving any marks using a traditional ammonium chloride flux solution.

Achieved environmental benefits

- Reduced generation of dust at source.
- Reduced hard zinc generation.
- Reduced energy consumption (electricity) from the operation of air abatement treatment systems.

Environmental performance and operational data

Fluxing agents based on zinc chloride/alkali chloride do not result in an additional pickling effect during hot dipping and therefore do not dissolve more iron. This reduces the generation of hard zinc on one hand, but also requires optimum pickling in the pretreatment section to achieve high quality coatings. [144, ABAG 1993]

A typical (commercially available) low fume flux has replaced the majority of the ammonium chloride content with potassium chloride that releases far less fume during the dipping operation. The consistency of a low fume flux can be in the range of 60 % zinc chloride, 30 % potassium chloride and 10 % ammonium chloride. This type of flux still produces fume during dipping, but at a much more reduced level than a traditional flux. [196, EGGA 2019]

Table 8.19: Emission comparison of normal and smoke-reducing fluxing agents

Fluxing agent	Emission	Work piece	Zinc ash
ZnCl ₂ : 89 % NH ₄ Cl: 11 % Salt content: 170 g/l	33 %	2 %	65 %
ZnCl ₂ : 32 % KCl: 68 % Salt content: 170 g/l	19 %	1 %	80 %

Source: [144, ABAG 1993]

Of the plants that took part in the data collection, 17 plants in six MS (DK, ES, FR, NL, UK, SE) reported the use of low-fume flux. The majority of the plants applied additional fume abatement by fabric filter; only 6 plants (5 from UK and 1 from DK) reported air extraction without abatement. Figure 6.16 shows the reported data on dust emissions from plants using low-fume flux without abatement (5 UK plants). The dust emission concentrations range from 1 mg/Nm³ to 8.3 mg/Nm³. Dust mass flows between 27 g/h and 205 g/h were reported.

Cross-media effects

- Zinc ash may be increased (reported by some sources).
- Smoke-reducing fluxing agents produce less visible fumes. The visibility of fumes is a function of particle size. Accordingly, there is a potential for smaller size particles with smoke-reducing fluxing agents which could give rise to adverse health effect of respirable dust. [140, UK Galvanisers 2000]. Results from occupational exposure surveys, however, state no health concerns between the different flux types and no concerns over the size of the airborne particulate. [153, Piatkiewicz 1999]
- The amount of total dust released to the atmosphere is greater than when using a 'traditional' flux and abatement equipment.

Technical considerations relevant to applicability

Applicability may be restricted due to product specifications.

Economics

- Savings from not having to install a bag filter (EUR 120 000).
- Savings on electricity consumption.
- No filter dust to be sent for disposal.

Driving force for implementation

Less energy being used and elimination of a difficult hazardous waste.

Example plants

BG plants from the data collections, plant codes: 75-1, 85, 165, 168-1,233, 251, 252, 254, 257, 259.

Reference literature

[140, UK Galvanisers 2000], [144, ABAG 1993], [153, Piatkiewicz 1999], [196, EGGA 2019].

8.8.6.2 Minimisation of carry-over of the fluxing solution

Description

This includes techniques such as:

- allowing enough time for the fluxing solution to drip off (see Section 8.6.3.5);
- drying before dipping.

Technical description

After withdrawing the workpieces from the flux bath, some of the water from the adhering fluxing fluid evaporates. The extent of evaporation depends on the temperature of the flux bath and, if the bath is hot, the rate of removal of workpieces from the bath (slower removal gives more evaporation). Further drying is sometimes achieved in dedicated drying. Exhaust gases from the galvanising kettle can sometimes be a useful indirect source of heat to such a drying unit, although ancillary burners are often also used. Drying of the workpiece helps reduce splashing and ejection of metal from the zinc bath as the workpiece is dipped, a benefit which is increased if the workpiece retains heat after leaving the dryer, i.e. if preheating is applied. [146, EGGA 2000]

This technique is not used in hot dip coating of sheets where fluxing is not carried out.

Achieved environmental benefits

Reduced emissions of zinc in hot dipping.

Environmental performance and operational data

No information provided.

Cross-media effects

None.

Technical considerations relevant to applicability

Generally, there are no technical restrictions to the applicability of this technique.

Economics

No information provided.

Driving force for implementation

Environmental legislation.

Example plants

Widely used.

Reference literature

[146, EGGA 2000].

8.8.6.3 Air extraction as close as possible to the source

Description

For emissions from hot dipping after fluxing in hot dip coating of wires and in batch galvanising, air from the kettles is extracted, for example using lateral hood or lip extraction.

Technical description

The galvanising kettle is equipped with lip extraction to collect emissions from hot dipping after fluxing in hot dip coating of wires and in batch galvanising. The emissions are treated using fabric filters (see Section 8.8.1.3). Figure 8.49 and Figure 8.50 show bilateral-lip extraction systems at galvanising plants.

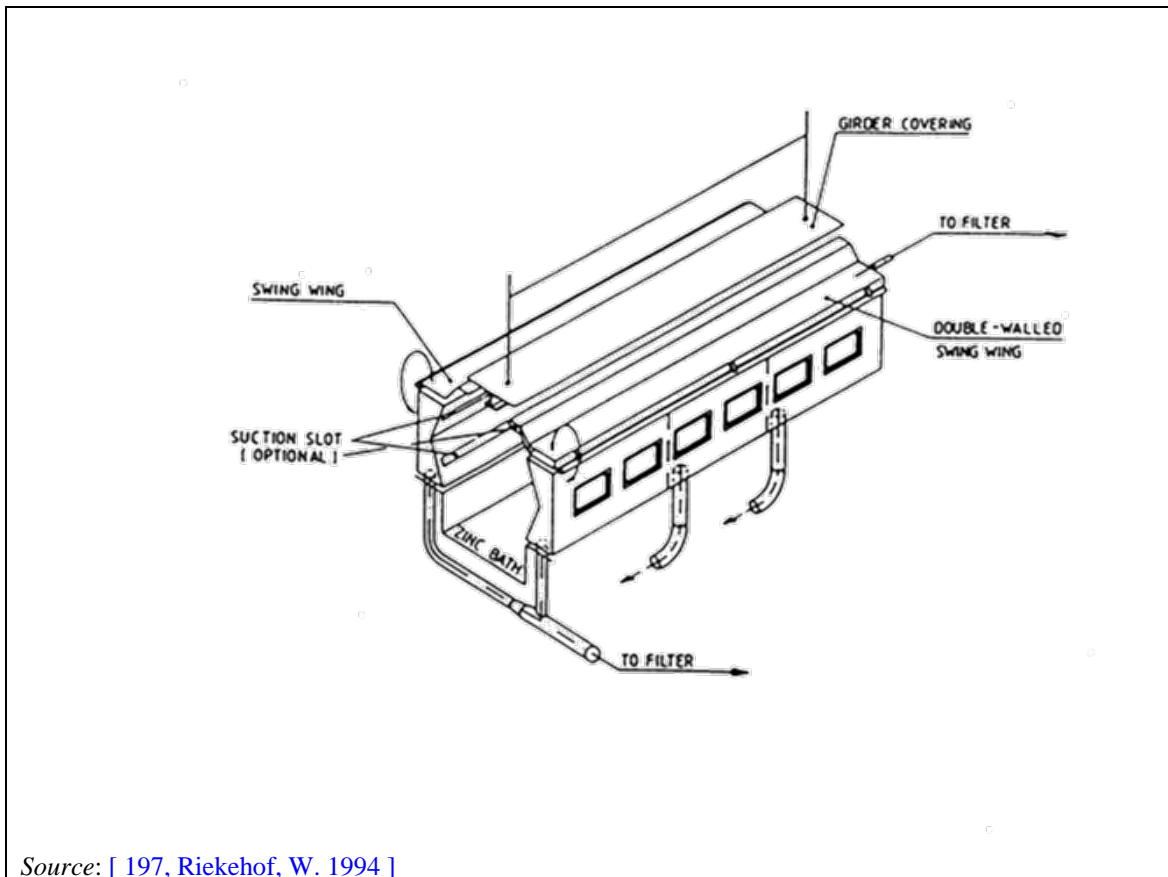


Figure 8.49: Bilateral peripheral exhaust with auxiliaries



Figure 8.50: Lip extraction at a batch galvanising plant

Achieved environmental benefits

Reduced emissions of dust and metals.

Environmental performance and operational data

Table 8.20 gives some examples of emissions from a galvanising kettle under different conditions (Wilhelm Hähn, Germany).

Table 8.20: Examples for emissions from a galvanising kettle

Point of measurement	As ³⁺ [µg/m ³]	Cd ³⁺ [µg/m ³]	Pb ²⁺ [µg/m ³]	Zn ²⁺ [mg/m ³]	NH ₄ ⁺ [mg/m ³]	Cl ⁻ [mg/m ³]	Dust [mg/m ³]
Above zinc surface without air extraction	106.9	117.2	125.3	44.5	197.9	14.3	384.6
Above zinc surface with air extraction	1.4	2.9	53.1	0.9	0.2	1.2	0.5
Crude gas	3.6	5.1	49.0	6.2	17.5	7.4	24.1
Cleaned gas	0.1	0.1	1.8	0.017	9.0	2.7	0.1

Source: [198, Hähn 1983]
Based on case study: lip extraction, 3380 m³/m²·h = 32958 m³/h, abatement: bag filter

The emissions data are mean values from six individual measurements with an average measuring period of 18 minutes, calculated as absolute immersion period with two to four dipping operations each. Replicate measurements conducted in 1996 confirmed these data and showed the following results: dust < 0.13 mg/m³ and HCl 0.9 mg/m³. These values were mean values from four individual measurements with an average measuring period of 28 minutes, calculated as absolute immersion period with three to four dipping operations each. Fabric filters showed reduction efficiencies of 99.6 %.

Table 8.23 summarises the dust emissions of galvanising plants from the FMP data collection for which emissions from the galvanising kettles were collected using lip extraction and treated using fabric filters.

Table 8.21: Dust emissions from galvanising plants equipped with lip extraction and fabric filters (FMP data collection).

Substance	Concentrations reported over 3-year period - (mg/Nm ³)					Number of plants / number of measurements
	Average	Median	90 th percentile	Min.	Max.	
Dust	1.5	0.8	4.2	0.05	28.0	6 / 16

Source: [16, FMP TWG 2018]

Cross-media effects

- Energy consumption (electrical energy is used for extraction fans, filter cleaning, and possibly filter heating).

Technical considerations relevant to applicability

Generally, there are no technical restrictions to the applicability of this technique.

Economics

No information provided.

Driving force for implementation

Environmental legislation.

Example plants

Wilhelm Hähn, Kreuztal-Ferndorf, Germany.

Plants from the FMP data collection: 85, 188, 198, 227, 258, 261.

Reference literature

[198, Hähn 1983].

8.8.6.4 Enclosed kettles combined with air extraction**Description**

Hot dipping is carried out in an enclosed kettle and air is extracted.

Technical description

In hot dip coating of wires and batch galvanising, the galvanising kettle is equipped with an enclosing hood. The emissions are treated using fabric filters (See Section 8.8.1.3). This technique is not employed in continuous hot dip coating of sheets given that the strip immersion point is already under protective atmosphere (sealed) and that no fumes are coming out.

The hood is a steel structure that is built on top of the galvanising kettle. In this case it is equipped with sliding horizontal doors or short end doors to allow access to the zinc bath. In some cases the hood is designed as mobile hood that is attached to overhead crane systems and can be lifted. This design is usually applied when the racks enter the galvanising bath from one of the two long sides.

Figure 8.51 and Figure 8.52 show some examples of enclosure designs.

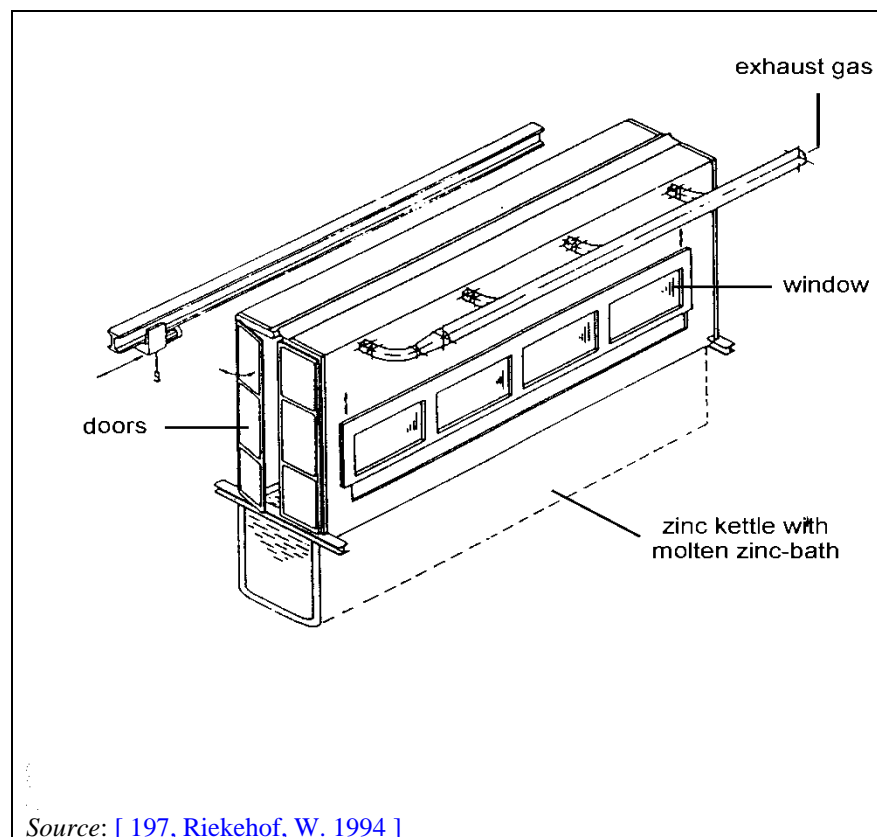
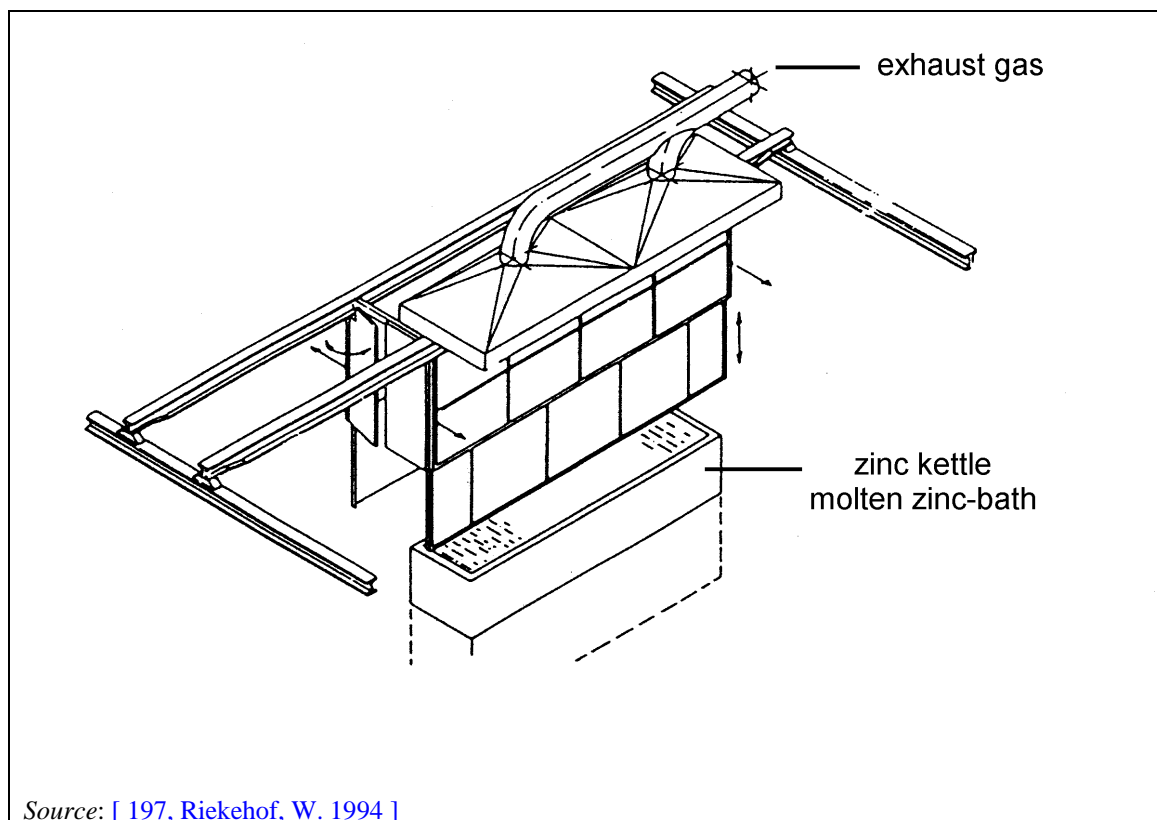


Figure 8.51: Stationary enclosure



Source: [197, Riekehof, W. 1994]

Figure 8.52: Moveable enclosure with vertical moving side walls

Achieved environmental benefits

- Reduction of fugitive air emissions (reported 95–98 % capture of dust and other emissions). [199, BE, TWG member 2000]
- Reduction of squirts.
- Energy savings due to reduced surface heat loss from the galvanising bath. [146, EGGA 2000]

Environmental performance and operational data

Table 8.22 summarises the emissions of various substances from a batch galvanising plant equipped with air extraction and fabric filters.

Table 8.22: Emission concentrations of various substances from a batch galvanising plant (Verzinkerei Rhein-Main GmbH)

Substance	Emission ¹⁾ in mg/m ³
Dust	< 1
Zinc	0.03
ZnCl	0.1
NH ₄ Cl	32
HCl	< 10

1) Mean values from 8 individual measurements; average measuring period 32 minutes, calculated as absolute period of immersion with 5 to 8 dipping operations each
 Source: [200, Ackermann et al. 1987]; volume flow = 23400 m³/h; removal system: fabric filter

Table 8.23 summarises the dust emissions of galvanising plants from the FMP data collection where emissions from the galvanising kettle are captured by enclosures with air extraction and treated using fabric filters.

Table 8.23: Dust emissions from galvanising plants equipped with enclosed kettles are captured by enclosures with air extraction and treated using fabric filters (FMP data collection).

Substance	Concentrations reported over 3-year period - (mg/Nm ³)					Number of plants / number of measurements
	Average	Median	90 th percentile	Min.	Max.	
Dust	1.9	1.0	3.6	0.2	21.6	53 / 110

Source: [16, FMP TWG 2018]

In the FMP data collection, a large majority of batch galvanising plants reported the use of fabric filters to control dust emissions from the hot dipping process.

Cross-media effects

- Energy consumption (electrical energy is used for extraction fans, filter cleaning and possibly filter heating), but, compared to other suction systems, weaker suction is required (meaning less energy is needed). [199, BE, TWG member 2000]

Technical considerations relevant to applicability

Applicability to existing plants may be limited where enclosure interferes with an existing transport system for workpieces in batch galvanising.

Economics

No information provided.

Driving force for implementation

Environmental legislation.

Example plants

Verzinkerei Rhein-Main GmbH, Groß-Rohrheim, Germany.

Widely used (e.g. Plants 5, 23, 51, 57, 58, 163, 165, 169 in the FMP data collection).

Reference literature

[146, EGGA 2000], [199, BE, TWG member 2000], [200, Ackermann et al. 1987].

8.8.7 Emissions to air from oiling

8.8.7.1 Electrostatic oiling

Description

Oil is sprayed on the metal surface through an electrostatic field, which ensures homogeneous oil application and optimises the quantity of oil applied. The oiling machine is enclosed and oil that does not deposit on the metal surface is recovered and reused within the machine.

Technical description

Oiling machines are used for the purpose of applying a uniform film of rolling or anticorrosive oil on the strip surface. There are several technologies for oiling the finished products: roll coaters, conventional spraying systems and electrostatic oiling. Electrostatic oiling is employed more and more in cold rolling plants and appears to be standard practice in hot dip coating plants.

This oiling process is based on the electrostatic spraying of preservation oil on one side or on both sides of the strip. Oiling must guarantee a uniform coating with the required oil volume on the sheet surface, while the maximum allowable tolerance range between individual measurements is 0.5 g/m².

The operation principle of the electrostatic oiler is based on the use of electrostatic forces that concentrate on the edge of the blade which supplies the oil. The electrostatic forces interact with the oil which is an electrically resistive liquid and cause its dispersion in droplets of small diameter. As a result, a finely air-sprayed product cloud is obtained. The droplets of oil that have the same electrical charge repel each other and are attracted by the ribbon which has a charge of the opposite sign. The so-called inductor bars can be used in order to improve the stability of the electrostatic field and the homogeneity of oil distribution over the strip width.

The oiling machine is covered and the oil emissions are collected and reused within the machine. Electrostatic application is a more efficient and effective method of coating to minimise the amount of oil used within the system.

Recent developments in electrostatic oiling have focused on introducing new types of oil and in-line controlling thickness and thickness distribution systems of the oil film applied onto the steel surface. [[108, EUROFER 19-6-17 2017](#)]

If the pickled sheet (product) is to be used for cold rolling, oiling with rolling oil may not be required at the pickling line. On the other hand, oiling with anticorrosive oil is not necessary if the next process step follows immediately.

Achieved environmental benefits

- Reduced consumption of strips preservation oil. [[108, EUROFER 19-6-17 2017](#)]
- Reduced oil emissions. [[108, EUROFER 19-6-17 2017](#)]

Environmental performance and operational data

No information provided.

Cross-media effects

Increased energy consumption.

Technical considerations relevant to applicability

Generally, there are no technical restrictions to the applicability of this technique.

Economics

Investment costs for electrostatic oiling range between EUR 250 000 to EUR 500 000. [[136, Thuau 2020](#)]

Driving force for implementation

- Reduced costs due to increased material efficiency.
- Environmental legislation.

Example plants

Of 36 CR lines that took part in the data collection, 26 used electrostatic oiling, 7 reported spray oiling and 3 oiling rolls. All 40 HDC lines in the data collection used electrostatic oiling with covered machines.

Reference literature

[[108, EUROFER 19-6-17 2017](#)].

8.8.7.2 Enclosed oiling machine with air extraction followed by a demister

Description

The entire oiling machine is enclosed in order to avoid dispersion of oil mist and air is extracted. The oil which does not deposit on the metal surface is recovered and reused. Emissions are treated using a demister.

Technical description

Covered spray coating machines are used for the purpose of applying a uniform preservation oil film on the surface of cut material.

The covering of the strip oiling machine is necessary to avoid the dispersion of oil fumes in the working environment. The cover encloses the entire oiling machine completely. The oil is present in a tank where it is pumped out and sprinkled onto the tape surface. Other systems (working more like a coater-type, not electrostatic) can be open.

Oil mist emissions are extracted and treated using a demister (see Section 8.8.1.1)

Achieved environmental benefits

Reduction of the release of oil mists into the environment. [[70, EUROFER 31-5-17 2017](#)]

Environmental performance and operational data

No information provided.

Cross-media effects

None.

Technical considerations relevant to applicability

Generally applicable in plants equipped with this strip oiling device. [[127, Continuous Coating Shadow Group 1999](#)]

Economics

The investment cost is medium and the operating costs are low. [[127, Continuous Coating Shadow Group 1999](#)]

Driving force for implementation

Environmental legislation.

Example plants

Widely used.

Reference literature

[[70, EUROFER 31-5-17 2017](#)], [[127, Continuous Coating Shadow Group 1999](#)].

8.8.7.3 Contact lubrication

Description

Roller lubricators, e.g. felt rolls or squeeze rolls, are used in direct contact with the surface of coils and sheets. No oil mist is generated.

Technical description

When oiling of strip in slitting lines using contact lubrication (e.g. felt rolls or squeeze rolls) is employed, no oil mist is generated. The oil is supplied through piping at different zones inside the felt roll. The felt roll applies the lubricant very homogeneously on the strip. The oil dosage can be adjusted precisely using a control unit function of the needs as and the rolling speed. The small amounts of oil from the side of the strip is collected and reused.

Achieved environmental benefits

- Reduction of the release of oil mists into the environment.
- Precise and economic oil consumption.

Environmental performance and operational data

Contact lubrication is performed principally without generation of undesirable oil mist.

Cross-media effects

None.

Technical considerations relevant to applicability

Generally applicable e.g. in slitting lines, mills equipped with strip oiling device as well as for sheets and boards.

Economics

The investment cost is low, with low wear and low maintenance costs.

Investment costs for oiling without compressed air and contact lubrication range between EUR 40 000 and EUR 120 000. The lower end of the cost range generally applies to oiling devices found in slitting departments whereas the higher end of the cost range is more relevant to wide strips / continuous running lines / temper mills. [[136, Thuau 2020](#)]

Driving force for implementation

Environmental legislation.

Example plants

Slitting lines in slitting departments of cold rolling mills.

Reference literature

[[41, EUROFER 2020](#)].

8.8.7.4 Oiling without compressed air

Description

Oil is applied with nozzles close to the metal surface using high frequency valves.

Technical description

The spray lubrication system with the nozzles close to the strip work with high frequency valves and does not require any compressed air. The oil is present in a tank where it is pumped through the nozzles. The oil dosage can be adjusted precisely by a control unit to the needs and the rolling speed. Oil collected at the edge of the strip is recirculated.

Achieved environmental benefits

- Reduction of the release of oil mists into the environment.
- Precise and economic oil consumption.

Environmental performance and operational data

The system is practically oil mist-free and there is no need for an exhaust system.

Cross-media effects

None.

Technical considerations relevant to applicability

Generally applicable e.g. in slitting lines, mills equipped with strip oiling device as well as for sheets and boards.

Economics

The investment cost is low, with low wear and low maintenance costs.

Driving force for implementation

Environmental legislation.

Example plants

Slitting lines in slitting departments of cold rolling mills.

Reference literature

[41, EUROFER 2020].

8.8.8 Emissions to air from acid recovery**8.8.8.1 Use of a fuel or a combination of fuels with low sulphur content and/or low NO_x formation potential****Description**

Fuels with low sulphur content include e.g. natural gas, liquefied petroleum gas, blast furnace gas, basic oxygen furnace gas and CO-rich gas from ferrochromium production.

Fuels with a low NO_x formation potential include e.g. natural gas, liquefied petroleum gas, blast furnace gas and basic oxygen furnace gas.

Environmental performance and operational data

Results from the FMP data collection showed that all the acid recovery plants using spray roasting or fluidised bed regeneration used only natural gas as fuel and exhibited very low SO₂ emission values (typically below 10 mg /Nm³ – See Figure 7.3). In the previous FMP BREF, much higher SO₂ emission limits for acid recovery plants using spray roasting or fluidised bed regeneration were specified (from 100 to 200 mg/Nm³). This was possibly to account for the use of gases with a higher sulphur content (e.g. COG) at that time, however it was confirmed that such gases are not employed at the time of writing this document in these acid recovery plants.

Technical considerations relevant to applicability

Applicable within the constraints associated with the availability of different types of fuel, which may be impacted by the energy policy of the Member State.

More information on the technique

See Section 2.4.2.1.

8.8.8.2 Furnace automation and control**More information on the technique**

See Section 8.5.3.3.

8.8.8.3 Combustion optimisation**More information on the technique**

See Section 8.5.3.2.

8.8.8.4 Low-NO_x burners**More information on the technique**

See Section 8.8.2.8.

8.8.8.5 Wet scrubbing followed by a demister

More information on the technique

See Sections 8.8.1.7 and 8.8.1.1.

8.8.8.6 Selective catalytic reduction (SCR)

More information on the technique

See Section 8.8.1.4.

8.9 General techniques to reduce emissions to water

This section gives a short overview of the techniques used in the FMP sector to reduce emissions to water. All these techniques are extensively described in the CWW BREF. [[168, COM 2016](#)]

8.9.1 Adsorption

Description

The removal of soluble substances (solutes) from the waste water by transferring them to the surface of solid, highly porous particles (typically activated carbon).

Reference literature

[[168, COM 2016](#)].

8.9.2 Aerobic treatment

Description

The biological oxidation of dissolved organic pollutants with oxygen using the metabolism of microorganisms. In the presence of dissolved oxygen, injected as air or pure oxygen, the organic components are mineralised into carbon dioxide and water or are transformed into other metabolites and biomass.

Reference literature

[[168, COM 2016](#)].

8.9.3 Chemical precipitation

Description

The conversion of dissolved pollutants into an insoluble compound by adding chemical precipitants. The solid precipitates formed are subsequently separated by sedimentation, air flotation or filtration. If necessary, this may be followed by microfiltration or ultrafiltration. Multivalent metal ions (e.g. calcium, aluminium, iron) are used for phosphorus precipitation.

Reference literature

[[168, COM 2016](#)].

8.9.4 Chemical reduction

Description

Chemical reduction is the conversion of pollutants by chemical reducing agents into similar but less harmful or hazardous compounds.

Reference literature

[[168, COM 2016](#)].

8.9.5 Coagulation and flocculation

Description

Coagulation and flocculation are used to separate suspended solids from waste water and are often carried out in successive steps. Coagulation is carried out by adding coagulants with

charges opposite to those of the suspended solids. Flocculation is carried out by adding polymers, so that collisions of microfloc particles cause them to bond to produce larger flocs.

Reference literature

[\[168, COM 2016\]](#).

8.9.6 Equalisation

Description

Balancing of flows and pollutant loads at the inlet of the final waste water treatment by using central tanks. Equalisation may be decentralised or carried out using other management techniques.

Reference literature

[\[168, COM 2016\]](#).

8.9.7 Filtration

Description

The separation of solids from waste water by passing them through a porous medium, e.g. sand filtration, microfiltration and ultrafiltration.

Reference literature

[\[168, COM 2016\]](#).

8.9.8 Flotation

Description

The separation of solid or liquid particles from waste water by attaching them to fine gas bubbles, usually air. The buoyant particles accumulate at the water surface and are collected with skimmers.

Reference literature

[\[168, COM 2016\]](#).

8.9.9 Nanofiltration

Description

A filtration process in which membranes with pore sizes of approximately 1 nm are used.

Reference literature

[\[168, COM 2016\]](#).

8.9.10 Neutralisation

Description

The adjustment of the pH of waste water to a neutral level (approximately 7) by the addition of chemicals. Sodium hydroxide (NaOH) or calcium hydroxide (Ca(OH)₂) is generally used to increase the pH, whereas sulphuric acid (H₂SO₄), hydrochloric acid (HCl) or carbon dioxide (CO₂) is generally used to decrease the pH. The precipitation of some substances may occur during neutralisation.

Reference literature

[168, COM 2016].

8.9.11 Physical separation**Description**

The separation of gross solids, suspended solids, metal particles from the waste water using, for example, screens, sieves, grit separators, grease separators, hydrocyclones, oil-water separation or primary settlement tanks.

Reference literature

[168, COM 2016].

8.9.12 Reverse osmosis**Description**

A membrane process in which a pressure difference applied between the compartments separated by the membrane causes water to flow from the more concentrated solution to the less concentrated one.

Reference literature

[168, COM 2016].

8.9.13 Sedimentation**Description**

The separation of suspended particles and suspended material by gravitational settling.

Reference literature

[168, COM 2016].

8.9.14 Treatment of water contaminated with oil or grease**Description**

Water contaminated with oil or grease (e.g. from oil spillages or from the cleaning of rolling or tempering emulsions, degreasing solutions and wire-drawing lubricants) are treated to reduce the load of organic pollutants. The organic phase is separated from the aqueous phase, e.g. by skimming or by emulsion splitting with suitable agents, evaporation or membrane filtration. The organic phase may be used for energy or material recovery (e.g. See Section 8.11.1.6).

Technical description

Rolling or tempering emulsions from the mill stands and wire drawing lubricants pick up particulate matter, steel slivers, scale and dust during operation. As the degree of contamination rises, these impurities affect the quality of the product and lead to process failure. To enable emulsion systems to be run as circulation systems and to extend the lifetime of the emulsions, the cleanliness is controlled closely.

Solids can be removed from emulsions by gravity in **settling tanks, separators, mesh filters, magnetic filters, etc.**

To remove solids, a **centrifuge** utilises centrifugal forces. Dirty liquid is fed into the spinning rotor or bowl, whereby the liquid is accelerated and distributed onto the internal walls of the bowl. The solids separate and compact at the perimeter of the bowl. The solids remain in the bowl while the liquid exits, as it is displaced by the incoming liquid.

Once the bowl fills to the maximum allowable capacity with waste solids, the automatic cleaning cycle is activated. At this point, the feed of dirty liquid is shut off and the rotor comes to a complete stop. The internal scraping blades then rotate back and forth against the rotor while removing the solids, which are dumped into a collection hopper. [124, El-Hindi et al. 1999]

Depending on the particle size of the solids, **mesh filters** or **media filtration** using disposable paper can be used. The liquid is forced through the filter medium which extracts the fines, by gravity, pressure or vacuum.

However, a partial flow of the emulsion may need to be withdrawn from the system to maintain quality.

The partial flow discarded from the emulsion circuit systems requires treatment prior to discharge. This treatment basically constitutes the separation of the water and the oil phase (emulsion splitting). The purified water is discharged. The separated oil or oil-containing sludge may be reused, e.g. thermally by incineration (see Section 8.11.1.6).

Treatments available comprise:

- thermal: by evaporation and splitting with chemical additions;
- chemical: acid splitting, salt splitting, combined dosage of coagulants and polyelectrolytes;
- flotation;
- adsorption;
- electrolytical;
- membrane filtration (ultrafiltration, reverse osmosis).

Thermal breaking / Thermal emulsion splitting / Evaporation

Thermal breaking utilises a heat source, e.g. an internal heating tube or immersion gas burner, to raise the emulsion temperature to accelerate the evaporation rate, driving away the water content. The water exits as vapour, leaving the increasingly concentrated oil as a separate discharge. [124, El-Hindi et al. 1999]

The air saturated with water vapour is passed through coalescing elements to retain any possible droplets of coolant in the air stream prior to discharge. As an option, a condenser unit using a water-cooled coil can be installed in the discharge stack to retrieve the water as condensate. This water stream can then be used as make-up water to be reintroduced to the emulsion system. [124, El-Hindi et al. 1999]

The concentrated oil left in the chamber is subjected to a cook-down cycle to drive out more water. By thermal breaking, an emulsion with an initial concentration of 5–7 % oil can ultimately be reduced to 90 % oil and 10 % water. With more water removed, the disposal volume and cost are much less. With the greater concentration of oil, the reuse option or incineration is more feasible. [124, El-Hindi et al. 1999]

Chemical breaking of emulsions

In splitting with acid/salt, the emulsified oil will mostly be adsorbed to sludge and will not be separated as an oil phase. The addition of acids, iron/aluminium salts or polyelectrolytes causes the oil emulsion to destabilise due to the neutralisation of the charged colloidal oil particles. Splitting of oil-containing emulsions with acids or salts is not a state-of-the-art technique, due to the generation of large amounts of oil-containing neutralisation sludges and the contamination of waste water by salt. Acids/salts can be used as after-treatment in combined processes if only small amounts of residual oil need to be removed.

Polyelectrolytes soluble in the oil phase (so-called organic splitters, e.g. tertiary and quaternary polyamines) do not produce sludge during the splitting process itself, but generate a liquid oil

phase which can be removed and utilised. This process can be used to treat emulsions with a high content of emulsified oil (a well-suited pretreatment technique when a combination of processes is applied). Polyelectrolytes (often used in combination with absorbents) through which the proportion of emulsified oil is bound within flocs and which produce a removable sludge (flotation or sedimentation) should only be used when the oil content is low (less than 300 mg/l), in order to reduce flocculant consumption, sludge volume and, thereby, costs. When a combination of processes is applied, flocculation can be used as an after-treatment. [[80, DE, TWG member 2000](#)]

Flotation

Flotation is a gravity separation process using different density of two media. The lighter medium (e.g. oil) is collected at the surface of the heavier medium (e.g. water) in a tank with low turbulence. Even heavier media (e.g. flocs) can be collected at the water surface if flocs are made lighter by gas bubbles sticking to the flocs. Gas bubbles must be smaller than the flocs, otherwise they will not stick. Small bubbles are usually produced by pressurising water and gas together (dissolved air flotation), electrolytically (water split into hydrogen and oxygen gas bubbles) or by high shear forces (mechanical dispersing of gas into water). [[201, AT, TWG member 2000](#)]

Flotation emulsion breaking usually means a two-step process consisting firstly of chemical emulsion breaking (by dosing acid, flocculents and polyelectrolyte or electrochemically by dissolving the anode) and secondly of flotation for separating the flocs from water. [[201, AT, TWG member 2000](#)]

The layer of floating sludge forming at the water surface (flotate) is removed mechanically. In general, flotation techniques can be distinguished *inter alia* by the way the gas bubbles are produced:

- pressure relief flotation (introduction of air-saturated pressurised water);
- electroflotation (electrolytical decomposition of water with formation of hydrogen and oxygen bubbles);
- dispersion flotation (generation of microbubbles through injection of air via a hollow shaft).

No additional solids arise in the flotata sludge when polyelectrolytes are used for emulsion splitting instead of acids/salts. [[80, DE, TWG member 2000](#)]

Adsorption

Adsorption means adhering the oil particles to the surface of a solid or semisolid adsorbent. The adsorbent may either be a fixed bed of solids (e.g. activated carbon) through which the emulsion is flowing or may be a powdered solid (e.g. activated carbon) or semisolid flocs (e.g. iron hydroxide) distributed into the liquid. Powder or flocs have to be finally separated from liquid by settling, flotation or filtering. [[201, AT, TWG member 2000](#)]

Oil-contaminated adsorbent has to be discharged when exhausted and treated as sludge or has to be burnt (or sometimes regenerated in case of fixed beds).

Fixed bed adsorbers and powder-type adsorbers are only usable for very low oil concentrations; otherwise adsorbent is exhausted too fast and is therefore too expensive. It is not common as basic emulsion treatment but it is sometimes used as a final polishing step of other types of emulsion breaking. Adsorption to semisolid flocs is part of the chemical emulsion breaking. [[201, AT, TWG member 2000](#)]

A special kind of adsorbers are coalescing filters. These filters are filled with regular or irregular wire mesh, plastic or ceramic filling and will cause small oil droplets to collect and adhere to this filling. If collected oil volume increases, oil droplets (now bigger in size) will escape and

rise up to the water surface from where they are skimmed off. Coalescing filters are sometimes used as emulsion pretreatment to remove free oil droplets from an emulsion. [201, AT, TWG member 2000]

The use of adsorbents for treating spent emulsions consumes large amounts of chemicals and generates considerable amounts of oil-containing waste sludge. [80, DE, TWG member 2000]

Electrolytic emulsion splitting

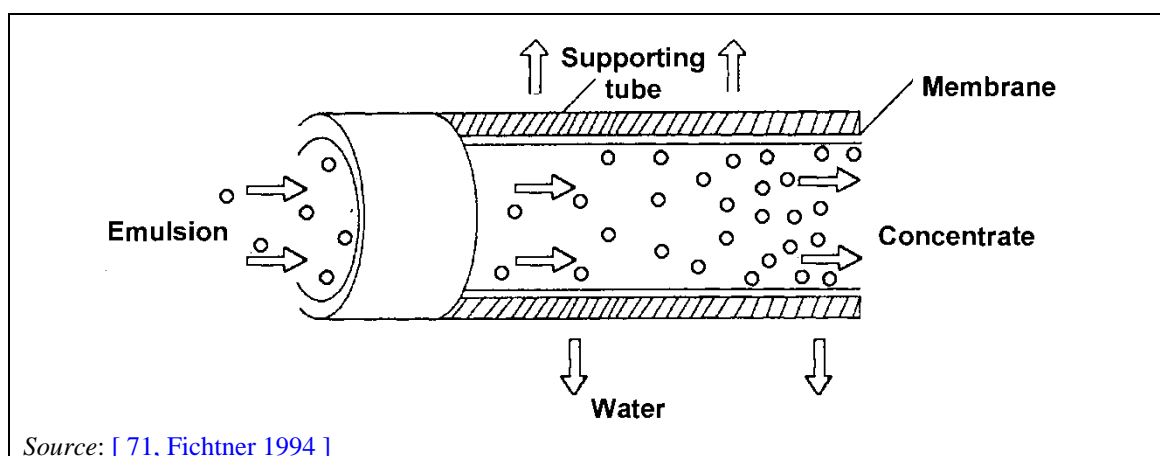
In electrolytic emulsion splitting, aluminium anodes are dissolved; the resulting sludge flakes bond to the oil and float. To improve the separation effect, polyelectrolyte can be added. In addition, control of the pH value and the electrical conductivity is maintained.

All of the oil contained in the emulsion has to be removed as sludge. The process does not produce an oil phase fit for use. [80, DE, TWG member 2000]

Ultrafiltration

A successful alternative for emulsion with low initial oil concentration ($< 2\%$) is the use of ultrafiltration (UF) (see Figure 8.53) to mechanically split out the oils or soaps. The oil is separated at the molecular level, as the emulsion is forced through membrane filters. The membranes block oil molecules, while the water molecules pass through. The water, which passes through, is called permeate, while the restrained oil is called concentrate. Typically, the concentration of the concentrate (oil) does not exceed 25 % and is limited by the plugging of the membranes. As membranes are plugged, the ultrafilter cartridges must be periodically backwashed. [124, El-Hindi et al. 1999]

The average separation efficiency of UF, related to normal industrial water, is approximately 40 l/h per m² of filter surface. [4, EUROFER 1998]



Source: [71, Fichtner 1994]

Figure 8.53: Principle of ultrafiltration

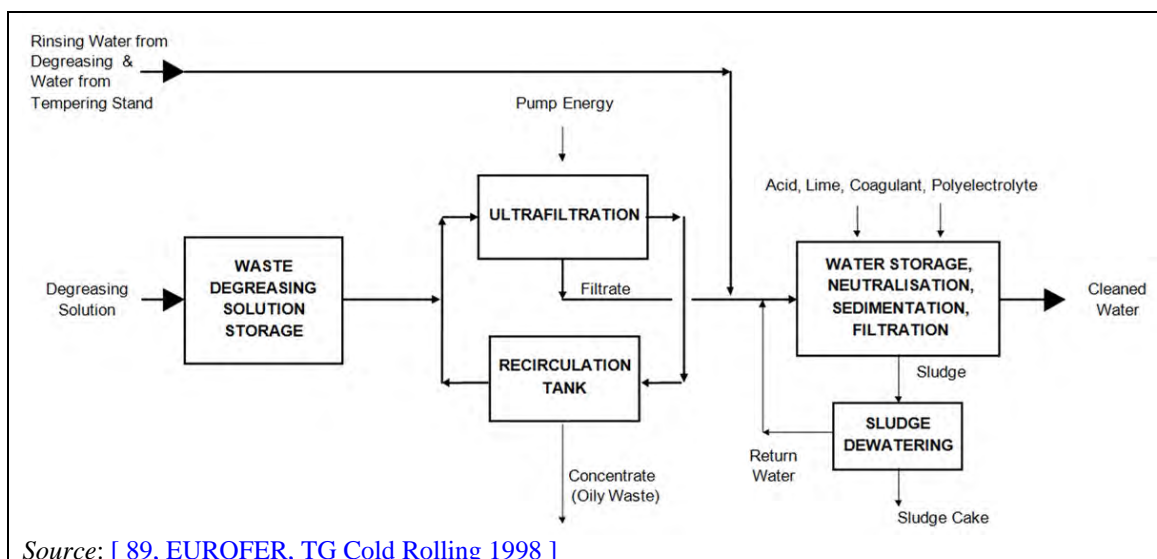
Achieved environmental benefits

Reduction of TOC, COD, TSS, HOI and metal emissions.

Environmental performance and operational data

Figure 8.54 provides an example of the treatment of spent degreasing bath solutions and alkaline waste water solutions in a continuous annealing line. Partial flows from the degreasing solution cleaning circuit, rinsing water from the electrolytic degreasing and waste water from the skin pass mill stand, which cannot be reused in the mills, have to be treated prior to discharge. Prior to treatment of the waste water with flocculants, the oil content has to be removed, e.g. by oil-water separation or ultrafiltration. [25, EUROFER 2018], [80, DE, TWG member 2000]

Then, the waste water is usually neutralised with lime or HCl in a neutralisation plant, passed through filters and finally discharged. The sludge is dewatered in filter presses and discharged for landfill deposit. The oil sludge from the ultrafiltration plants can be used in the blast furnaces. [89, EUROFER, TG Cold Rolling 1998]



Source: [89, EUROFER, TG Cold Rolling 1998]

Figure 8.54: Spent degreasing solution flow (example of a continuous annealing line)

Table 8.24 presents input/output data and effluent data for alkaline (degreasing) waste water treatment by ultrafiltration (continuous annealing line).

Table 8.24: Operational and effluent data for alkaline waste water treatment

Input / Consumption Level				
Raw waste water		12 - 15		kg/t
Citric acid		occasionally		kg/t
Electrical energy		1 - 1.5		MJ/t
Output / Emission Level				
Purified waste water		12 - 15		kg/t
Sludge				kg/t
	Concentration [mg/l]	Specific Emission [g/t product]	Reduction rate ¹ [%]	Method of analysis
Suspended solids (filterable)	20 - 40	2.35 - 4.7 E -4	> 90	DIN 38409-H2
Σ Hydrocarbons (oil, grease)	5 - 8	5.9 - 9.4 E -5	> 90	DIN 38409-H18
COD	5000 - 6000	5.9 - 7.1 E -5	> 50	DIN 38409-H44
Temperature	30 °C			Thermometer
pH	6.5 - 9.5			
Note: Source: [89, EUROFER, TG Cold Rolling 1998]. Data based on weekly, volume proportional 24-h sampling				
¹ Reduction rate based on mass flow of constituent				

Cross-media effects

Energy and raw material consumption.

Technical considerations relevant to applicability

Generally, there are no technical restrictions to the applicability of this technique.

Economics

No information provided.

Driving force for implementation

Environmental legislation.

Example plants

Aviles 2, Florange, Sagunto. [[25, EUROFER 2018](#)]

Acerinox Europe. [[25, EUROFER 2018](#)]

Reference literature

[[4, EUROFER 1998](#)], [[25, EUROFER 2018](#)], [[71, Fichtner 1994](#)], [[80, DE, TWG member 2000](#)], [[124, El-Hindi et al. 1999](#)], [[201, AT, TWG member 2000](#)].

8.10 General techniques to reduce noise and vibrations

8.10.1 Noise and vibration management plan

Description

Implementation of a noise and vibration management plan as part of the environmental management system (EMS) (see Section 8.1.1).

Technical considerations relevant to applicability

Generally, there are no technical restrictions to the applicability of this technique.

Reference literature

[[167, Pinasseau et al. 2018](#)].

8.10.2 Appropriate location of equipment and buildings

Description

Noise levels can be reduced by increasing the distance between the emitter and the receiver, by using buildings as noise screens and by relocating the exits or entrances of the buildings.

Technical considerations relevant to applicability

For existing plants, the relocation of equipment and the exits or entrances of the buildings may not be applicable due to a lack of space and/or excessive costs.

Reference literature

[[167, Pinasseau et al. 2018](#)].

8.10.3 Operational measures

Description

These include techniques such as:

- improved inspection and maintenance of equipment;
- closing of doors and windows of enclosed areas, if possible;
- equipment operation by experienced staff;
- avoidance of noisy activities at night, if possible;
- provisions for noise control, e.g. during production and maintenance activities, transport and handling of feedstock and materials.

Technical considerations relevant to applicability

Generally, there are no technical restrictions to the applicability of this technique.

Reference literature

[[167, Pinasseau et al. 2018](#)].

8.10.4 Low-noise equipment

Description

This includes techniques such as direct drive motors, low-noise compressors, pumps and fans.

Technical considerations relevant to applicability

Generally, there are no technical restrictions to the applicability of this technique.

Reference literature

[167, Pinasseau et al. 2018].

8.10.5 Noise and vibration control equipment

Description

This includes techniques such as:

- noise reducers;
- acoustic and vibrational insulation of equipment;
- enclosure of noisy equipment (e.g. scarfing and grinding machines, wire drawing machines, air jets);
- building materials with high sound insulation properties (e.g. for walls, roofs, windows, doors).

Technical considerations relevant to applicability

Applicability to existing plants may be restricted by a lack of space.

Reference literature

[167, Pinasseau et al. 2018].

8.10.6 Noise abatement

Description

Inserting obstacles between emitters and receivers (e.g. protection walls, embankments and buildings).

Technical considerations relevant to applicability

Only applicable to existing plants, as the design of new plants should make this technique unnecessary. For existing plants, the insertion of obstacles may not be applicable due to a lack of space.

Reference literature

[167, Pinasseau et al. 2018].

8.11 Residues

8.11.1 General techniques for residues management

8.11.1.1 Residues management plan

Description

A residues management plan is part of the EMS (see Section 8.1.1) and is a set of measures aiming to 1) minimise the generation of residues, 2) optimise the reuse, recycling and/or recovery of residues, and 3) ensure the proper disposal of waste.

The residues management plan may be integrated in the overall residues management plan of a larger installation (e.g. for iron and steel production).

Technical considerations relevant to applicability

The level of detail and the degree of formalisation of the residues management plan will generally be related to the nature, scale and complexity of the installation.

Reference literature

[[167, Pinasseau et al. 2018](#)].

8.11.1.2 Pretreatment of oily mill scale for further use

Description

This includes techniques such as:

- briquetting or pelletising;
- reducing the oil content of oily mill scale, e.g. by thermal treatment, washing, flotation.

Technical description

Hot rolling generates valuable oily mill scale residues which are recycled either towards the sinter plant or other iron- and steel-making furnaces. If recycled to the sinter plant, oily mill scale exhibiting a high oil content (fine scale sludge) is pretreated to reduce its oil content in order to prevent glow fires in the waste gas abatement system and emissions of organic pollutants (i.e. dioxins/VOCs). If recycled to other iron- and steel-making furnaces, oily mill scale is either directly injected or pretreated using briquetting or pelletising techniques prior to charging. [[31, EUROFER 10-7-18 2018](#)]

Techniques for recycling oily mill scale to the sinter plant

The direct utilisation of oily mill scale in sinter plants is restricted depending on the oil content. Coarse scale with a particle size of 0.5–5 mm and an oil content below 1 wt-% can be directly reused in the sinter plant without any pretreatment. [[22, COM, 2013 – Section 3.1.2](#)], [[188, COM, 2001](#)]

However, fine scale sludge which is composed of small scale particles (< 0.1 mm) and exhibiting a very high oil content (5–20 wt-%) cannot be directly reused in the sinter plant. Indeed, high oil content residues (> 3 wt-%) result in increased emissions of VOCs and potentially dioxins and can lead to significant safety issues for the waste gas abatement systems (i.e. electrostatic precipitators) with potential occurrence of glow fires when oil vapour formation takes place as a result of incomplete burning.

A non-exhaustive list of techniques used for pretreatment of mill scale and recycling at the sinter plant is provided below:

- Washing method for de-oiling mill scale
Fine scale sludge is mixed with water containing washing reagents to produce slurry which is charged into a high-shear stirring device. After stirring and rinsing, a phase separation between the de-oiled mill scale and the oily water emulsion occurs. The de-oiled mill scale (≤ 0.2 wt-% oil content) is recovered and dried prior being used in the sinter plant.
- Flotation method for de-oiling mill scale
Fine scale sludge is conditioned using water and chemical reagents and de-oiled in a three-stage flotation process.
- Revolving tubular furnace (thermal treatment for de-oiling)
Oily mill scale is dewatered and thermally de-oiled using a directly or indirectly heated furnace at temperatures between 450 °C and 470 °C. The product is an oil-free ferrous material exhibiting less than 0.1 wt-% oil content.
- Top-layer sintering technology
The top-layer sintering process principles are described in more detail in the IS BREF [[22, COM 2013](#)] (Section 3.3.2.5.2). Briefly, the top-layer sintering process uses a second ignition hood which ignites a second layer of materials deposited on top of the main sinter layer. The process consists of charging the oily mill sludge after the first ignition and the oil emulsion on the first flame front.

The main process steps are:

- pre-straining of the charge (mill scale, flue dust, etc.);
 - charging the waste mixture - approximately 10 m behind ignition - onto the already sintered primary charge, resulting in a secondary ignition.
- Thermal treatment of oily mill scale using rotary kilns
After dewatering and homogenisation, the oily mill scale is transported by a screw conveyor through a heating chamber to a rotary kiln where the material is continuously processed at temperatures between 400 °C and 550 °C. Both the moisture and the oil content are thermally driven off and subsequently burned in a combustion chamber. De-oiled residues are reused at the sinter plant.

Figure 8.55 depicts the schematic of a rotary kiln installation at an ArcelorMittal integrated site for treatment of oily mill scale. The rotary kiln has a diameter of 2 m and a length of 10 m (Figure 8.56) and is heated by gas to 500–550 °C. The distilled moistness with oil is burnt in a combustion chamber heated by gas to 780 °C. The waste gas is cooled using a water scrubber below 250 °C and cleaned using a cyclone and a fabric filter. The collected dust (fine scale) is mixed together with the processed scale, ensuring that all residues are fully recycled (i.e. zero waste). [[40, EUROFER 31-3-17 2017](#)]

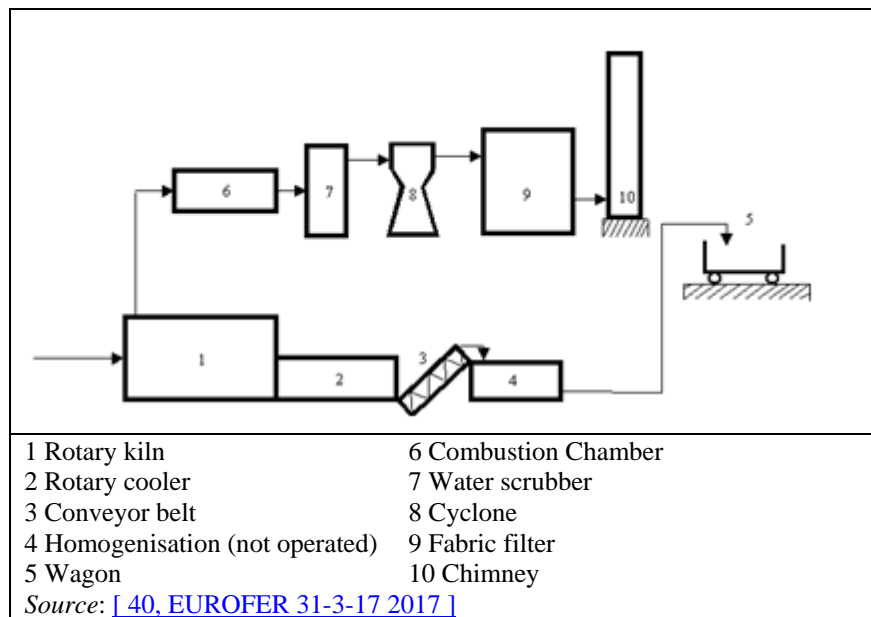


Figure 8.55: Schematic of a rotary kiln plant for thermal treatment of oily mill scale



Figure 8.56: Picture of a rotary kiln for thermal treatment of oily mill scale at an ArcelorMittal integrated plant

Techniques for recycling oily mill scale in other iron- and steel-making furnaces

A non-exhaustive list of techniques used for pretreatment of mill scale and recycling at iron- and steel-making furnaces is provided below:

- **Briquetting and converter charging**
Fine scale sludge is transformed into briquettes with the addition of binders (e.g. lime, molasses). The produced moulded bodies are of adequate consistency to be charged in the converter. The briquettes' cooling effect is sufficient for converter charging. Additives such as anthracite can be included to make the briquettes thermally neutral.
- **Blast furnace charging**
Several options are available to integrate the oily mill scale to the blast furnace charge including briquetting and top charging; injection via coal grinder through the tuyeres; pelletising and mixing with coal; injection as slurry directly into the tuyeres. However, all these practices are limited by the moisture and the oil content of the sludge as well as the process requirements.

- **Direct utilisation in the blast furnace (Voestalpine Stahl method)**

Scale is shot into the bottom of the blast furnace via a sludge burning lance. This is a very economical way to utilise the energy of the hydrocarbons and to reduce the iron oxide (scale) without needing an extra furnace and without producing additional environmental pollution, but it is only possible for blast furnaces equipped with a sludge or waste oil burning lance. It is important to inject the sludge at the bottom and not at the top of the furnace to ensure that the hydrocarbons are burnt and not only evaporated. Special care is required to ensure that all the hydrocarbons are effectively burnt in the process to prevent higher emissions in the blast furnace.

- **Carbofer**

Oily mill scale sludge is mixed with lime and coal dust and, optionally, iron- or carbon-bearing flue dust to obtain a dry mixture that is suitable for pneumatic injection into a reactor of the iron- and steel-making process, such as the blast furnace or the electric arc furnace. The blend is injected into the steel-making furnace either through a retractable consumable lance or via a water-cooled sidewall lance. Injection of the Carbofer mixture into the slag bath produces a good foaming slag. A full recovery of the injected materials can be expected. [[26, Hot Rolling Shadow Group 1999](#)]

Achieved environmental benefits

The environmental benefits resulting from the implementation of recycling technologies for oily mill scale residues are:

- reduction of raw materials used, e.g. decrease of the coke rate in the blast furnace (see Section 6.3.12.5 of the IS BREF [[22, COM 2013](#)]), or reduction of primary raw materials in the sinter plant (see Section 3.3.4 of the IS BREF); [[31, EUROFER 10-7-18 2018](#)]
- reduction of the amount of waste and the disposal rate. [[31, EUROFER 10-7-18 2018](#)]

Environmental performance and operational data

The capacity of the thermal rotary kiln de-oiling installation (at one of the ArcelorMittal integrated sites in Europe) is 20 000 t/yr. The processed scale from the rotary kiln has ≤ 0.1 wt-% oil content. [[31, EUROFER 10-7-18 2018](#)]

Cross-media effects

- De-oiling methods consume detergents or flocculating agents and result in oily waste water or residues from flotation.
- Thermal treatments result in emissions to air and increased energy consumption.
- The recycling of certain residues can contribute to an increase of metal emissions in the waste gas of the sinter plant. [[31, EUROFER 10-7-18 2018](#)]

Technical considerations relevant to applicability

Generally, there are no technical restrictions to the applicability of this technique.

Economics

The costs and benefits associated with this technique are summarised below:

- cost benefits obtained by reducing the use of virgin raw materials (i.e. iron ores) and reducing the coke rate;
- cost benefits obtained due to reduced quantities of waste sent for disposal;
- investment, operation and maintenance costs associated with the installation of de-oiling facilities for processing oily mill scales.

For most integrated steelworks, the financial benefits of recycling oily mill scale outweigh the costs of operating the de-oiling and waste water treatment facilities.

Driving force for implementation

- Reduction of costs due to reduced quantities of raw materials used.
- Reduction of costs due to reduced quantities of waste sent for disposal.
- Limited availability of options for waste disposal.

Example plants

Almost all sinter plants around the world utilise oily mill scale (after treatment) arising from integrated steelworks.

One example is Voestalpine Stahl GmbH (direct utilisation of oil residues in the blast furnace and reuse of scale in the sinter plant).

Reference literature

[[22, COM 2013](#)], [[31, EUROFER 10-7-18 2018](#)].

8.11.1.3 Use of mill scale**Description**

Mill scale is collected and used on site or off site, e.g. in iron and steel production or in cement production.

Technical description

Oil-free scale and low-oil-content (< 1 %) scale is fed directly back into the metallurgical process, usually via the sinter plant or the iron- and steel-making furnaces.

More information on the technique

Additional information on the technique may be found in Section 4.4.1.1.

8.11.1.4 Use of metallic scrap**Description**

Metallic scrap from mechanical processes (e.g. from trimming and finishing) is used in iron and steel production. This may take place on site or off site.

Technical description

Metallic by-products including scrap, downgrades, crop ends arising mostly from hot rolling are usually relatively clean and can easily be recycled back into metallurgical processes (e.g. BOF).

Achieved environmental benefits

Increased material efficiency.

Environmental performance and operational data

In hot rolling, the amounts of metallic scrap generated range between 70 kg/t and 150 kg/t of steel produced. [[28, AT, TWG member 1999](#)]

Cross-media effects

None.

Technical considerations relevant to applicability

Generally, there are no technical restrictions to the applicability of this technique.

Economics

Cost savings.

Driving force for implementation

Recover the iron content and reduce the consumption of primary raw materials.

Example plants

Widely used.

Reference literature

[[28, AT, TWG member 1999](#)].

8.11.1.5 Recycling of metal and metal oxides from dry waste gas cleaning

Description

The coarse fraction of metal and metal oxides originating from dry cleaning (e.g. fabric filters) of waste gases from mechanical processes (e.g. scarfing or grinding) is selectively isolated using mechanical techniques (e.g. sieves) or magnetic techniques and recycled, e.g. to iron and steel production. This may take place on site or off site.

Technical description

Dry or drained oxides that are mostly originating from dry air abatement cleaning systems (e.g. bag filters) in the rolling mills (including from grinding or scarfing operations) are recycled. The coarse fraction of oxides can be selectively isolated using magnetic or mechanical separation (sieves). This fraction can be directly reused in the sinter plant, in the blast furnace or in the steel plant to recover the iron content. [[82, DE, TWG member 1999](#)]

Achieved environmental benefits

- Reduced waste.
- Use of iron content.

Environmental performance and operational data

No information provided.

Cross-media effects

In some cases, oxides can contain oil requiring pretreatment for de-oiling the material prior to recycling (refer to Section 2.4.13.2). [[25, EUROFER 2018](#)]

Technical considerations relevant to applicability

Generally, there are no technical restrictions to the applicability of this technique.

Economics

No information provided.

Driving force for implementation

Reduction of waste disposal costs. [[25, EUROFER 2018](#)]

Example plants

Most integrated steelworks have facilities to recycle oxides. [[25, EUROFER 2018](#)]

Reference literature

[[25, EUROFER 2018](#)], [[82, DE, TWG member 1999](#)].

8.11.1.6 Use of oily sludge

Description

Residual oily sludge, e.g. from degreasing, is dewatered to recover the oil contained therein for material or energy recovery. If the water content is low, the sludge can be directly used. This may take place on site or off site.

Technical description

A variety of methods is used to remove oily sludge from the degreasing bath. This sludge contains solids together with a range of grease and oils. Depending on contaminant loading and calorific value, it can be used for other purposes, if necessary after dewatering. For example, the oily sludge may be removed from the site by a specialised contractor for the recovery of the oil contained therein. In some cases, if the water content is low, the sludge can be directly used as fuel. [[143, EGGA 1999](#)]

Achieved environmental benefits

Reduction of oil-containing waste sent for disposal.

Environmental performance and operational data

No information provided.

Cross-media effects

No information provided.

Technical considerations relevant to applicability

Generally, there are no technical restrictions to the applicability of this technique.

Economics

No information provided.

Driving force for implementation

Reduced disposal costs.

Example plants

Widely used.

Reference literature

[[143, EGGA 1999](#)].

8.11.1.7 Thermal treatment of hydroxide sludge from the recovery of mixed acid**Description**

Sludge generated from the recovery of mixed acid is thermally treated in order to produce a material rich in calcium fluoride that can be used in argon oxygen decarburisation converters.

Technical description

This technique consists of processing the hydroxide sludge obtained as by-product in a stainless steel mixed acid pickling line in order to reuse it as a slag former in AOD converters because of its high content in calcium fluoride (as a substitute for the commercial powder – CaF_2) (see Figure 8.57).

In mixed acid pickling plants, a pickling sludge is produced after neutralisation with $\text{Ca}(\text{OH})_2$. Typically, this pickling sludge after the filter press contains about 40–50 % CaF_2 , 5–30 % $\text{Ca}(\text{OH})_2$, 20–30 % $\text{Fe}(\text{OH})_3$, 5–9 % $\text{Cr}(\text{OH})_3$, 2–4 % $\text{Ni}(\text{OH})_2$ and 2–4 % SiO_2 . Using a thermal treatment in a rotary kiln, the hydroxide sludge is converted into a dark and strong material, designated as Hydrofluss, consisting mainly of CaF_2 , as well as chromium and nickel oxides. This product constitutes an excellent substitute for the fluorspar powder normally used as a slag former in the AOD process. [[202, World Patent 2005](#)]

Reference literature

[31, EUROFER 10-7-18 2018], [36, Lindfors et al. 2006], [202, World Patent 2005], [203, Schneiker et al. 2008].

8.11.2 Techniques for residues management in galvanising**8.11.2.1 Recycling of fabric filter dust****Description**

Dust from fabric filters containing ammonium chloride and zinc chloride is collected and reused, e.g. to produce fluxing agents. This may take place on site or off site.

Technical description

Precipitated dust from bag filters consists basically of ammonium chloride and zinc chloride (fluxing agent). The dust is collected, packed in bags and periodically sent for recycling to fluxing agent producers.

Achieved environmental benefits

Reduction of waste sent for disposal.

Environmental performance and operational data

No information provided.

Cross-media effects

No information provided.

Technical considerations relevant to applicability

- Only applicable in hot dipping after fluxing.
- Applicability may be restricted depending on the availability of a market.

Economics

Savings result from reduced costs for waste disposal.

Driving force for implementation

Reduced costs for waste disposal.

Example plants

Widely used.

Reference literature

No reference literature provided.

8.11.2.2 Recycling of zinc ash and top dross**Description**

Metallic zinc is recovered from zinc ash and top dross by melting in recovery furnaces. The remaining zinc-containing residue is used, e.g. for zinc oxide production. This may take place on site or off site.

Technical description

Metallic zinc that is trapped in zinc ash (i.e. zinc oxide), as a result of the skimming process, is recovered by melting in zinc recovery furnaces (at around 520 °C). The residual zinc ash floats on top of the molten zinc. The molten zinc (60–65 wt-%) is tapped and returned to the galvanising kettle. The remaining zinc-containing residue is sold to plants producing zinc oxide. [154, FI, TWG member 1999]

Achieved environmental benefits

- Increased material efficiency.
- Reduction of waste sent for disposal.

Environmental performance and operational data

The recycled zinc amount is 11.5 kg/t of galvanised steel.

Cross-media effects

No information provided.

Technical considerations relevant to applicability

Generally, there are no technical restrictions to the applicability of this technique.

Economics

An economic balance of operation on site needs to be performed as it is strongly influenced by the dross recovery price on one hand and the zinc price (London Metal Exchange – LME price) on the other hand. [[3, EUROFER 2020](#)]

Driving force for implementation

Cost savings due to the recovery of zinc.

Example plants

Four galvanising plants in Finland, including KS-Sinkki Oy, Lievestuore. [[103, FI, TWG member 2000](#)]

Reference literature

[[103, FI, TWG member 2000](#)], [[154, FI, TWG member 1999](#)].

8.11.2.3 Recycling of bottom dross

Description

Bottom dross is used, e.g. in the non-ferrous metals industries to produce zinc. This may take place on site or off site.

Technical description

Hard zinc (bottom dross) is a zinc-iron alloy that builds up in the bath. It results from the reaction of molten zinc with iron originating from the preceding pickling and fluxing baths, from the feedstock that is galvanised or from the kettle itself. Zinc may be recovered from this residue, e.g. in the non-ferrous metals industries to produce zinc.

Achieved environmental benefits

- Increased material efficiency.
- Reduction of waste sent for disposal.

Environmental performance and operational data

No information provided.

Cross-media effects

None.

Technical considerations relevant to applicability

Generally, there are no technical restrictions to the applicability of this technique.

Economics

Savings result from the recovery of zinc.

Driving force for implementation

Cost savings due to the recovery of zinc.

Example plants

Widely used.

Reference literature

No reference literature provided.

8.11.2.4 Environmental risk prevention from the storage of zinc-containing residues**Description**

Zinc-containing residues from hot dipping (i.e. zinc ash, top dross, bottom dross, zinc splashes and fabric filter dust) are stored separately from each other and from other residues on:

- impermeable surfaces, in enclosed areas and in closed containers/bags, for fabric filter dust;
- impermeable surfaces and in covered areas protected from surface run-off water, for all the other residue types above.

Technical description

Zinc-containing residues originate from hot dipping (i.e. zinc ash, top dross, bottom dross, zinc splashes and fabric filter dust). In order to improve their recyclability and recovery potential, these residues are stored separately from each other and from other residues as specified above.

Achieved environmental benefits

Prevention of contamination from the storage of residues.

Environmental performance and operational data

No information provided.

Cross-media effects

None.

Technical considerations relevant to applicability

Generally, there are no technical restrictions to the applicability of this technique.

Economics

No information provided.

Driving force for implementation

Environmental legislation.

Example plants

Widely used.

Reference literature

No information provided.

8.11.3 Techniques for residues management in wire drawing**8.11.3.1 Environmental risk prevention from the storage of lead-containing residues****Description**

Lead-containing residues from lead baths are stored separately from other residues, on impermeable surfaces and in enclosed areas or in closed containers.

Technical description

Lead-containing residues originate from the lead baths used in the wire drawing industry (e.g. protective layer materials and lead oxides). These residues are stored separately from other residues on impermeable surfaces and protected from rain and wind in enclosed areas or in closed containers.

Achieved environmental benefits

Prevention of contamination from the storage of residues.

Environmental performance and operational data

No information provided.

Cross-media effects

None.

Technical considerations relevant to applicability

Generally, there are no technical restrictions to the applicability of this technique.

Economics

No information provided.

Driving force for implementation

Environmental legislation.

Example plants

Widely used.

Reference literature

No information provided.

8.11.3.2 Recycling of lead-containing residues from wire drawing

Description

Lead-containing residues are recycled, e.g. to the non-ferrous metals industries to produce lead.

Technical description

Pb-containing residues originate from the lead baths (waste bath cover material, lead oxides, etc.). The wire industry depends on subcontractors for the final disposal or recycling of these residues. Normally, Pb-containing waste is recycled by the non-ferrous metals industry (Pb smelters). [[118, B. Gielen, Bekaert 1998](#)]

Achieved environmental benefits

Reduced waste disposal.

Environmental performance and operational data

No information provided.

Cross-media effects

None

Technical considerations relevant to applicability

Generally, there are no technical restrictions to the applicability of this technique.

Economics

No information provided.

Driving force for implementation

Reduced costs due to increased material efficiency.

Example plants

Widely used.

Reference literature

[\[118, B. Gielen, Bekaert 1998 \].](#)

9 BEST AVAILABLE TECHNIQUES (BAT) CONCLUSIONS FOR THE FERROUS METALS PROCESSING INDUSTRY

9.1 Scope

These BAT conclusions concern the following activities specified in Annex I to Directive 2010/75/EU:

- 2.3 Processing of ferrous metals:
 - (a) operation of hot rolling mills with a capacity exceeding 20 tonnes of crude steel per hour;
 - (c) application of protective fused metal coats with an input exceeding 2 tonnes of crude steel per hour; this includes hot dip coating and batch galvanising.
- 2.6 Surface treatment of ferrous metals using electrolytic or chemical processes where the volume of the treatment vats exceeds 30 m³, when it is carried out in cold rolling, wire drawing or batch galvanising.
- 6.11 Independently operated treatment of waste water not covered by Directive 91/271/EEC, provided that the main pollutant load originates from the activities covered by these BAT conclusions.

These BAT conclusions also cover the following:

- Cold rolling and wire drawing if directly associated with hot rolling and/or hot dip coating.
- Acid recovery, if directly associated with the activities covered by these BAT conclusions.
- The combined treatment of waste water from different origins, provided that the waste water treatment is not covered by Directive 91/271/EEC and that the main pollutant load originates from the activities covered by these BAT conclusions.
- Combustion processes directly associated with the activities covered by these BAT conclusions provided that:
 1. the gaseous products of combustion are put into direct contact with material (such as direct feedstock heating or direct feedstock drying), or
 2. the radiant and/or conductive heat is transferred through a solid wall (indirect heating):
 - without using an intermediary heat transfer fluid (this includes heating of the galvanising kettle), or
 - when a gas (e.g. H₂) acts as the intermediary heat transfer fluid in the case of batch annealing.

These BAT conclusions do not cover the following:

- metal coating by thermal spraying;
- electroplating and electroless plating; this may be covered by the BAT conclusions for Surface Treatment of Metals and Plastics (STM).

Other BAT conclusions and reference documents which could be relevant for the activities covered by these BAT conclusions include the following:

- Iron and Steel Production (IS);
- Large Combustion Plants (LCP);
- Surface Treatment of Metals and Plastics (STM);
- Surface Treatment using Organic Solvents (STS);
- Waste Treatment (WT);
- Monitoring of Emissions to Air and Water from IED Installations (ROM);

- Economics and Cross-Media Effects (ECM);
- Emissions from Storage (EFS);
- Energy Efficiency (ENE);
- Industrial Cooling Systems (ICS).

These BAT conclusions apply without prejudice to other relevant legislation, e.g. on the registration, evaluation, authorisation and restriction of chemicals (REACH), on classification, labelling and packaging (CLP).

9.2 Definitions

For the purposes of these BAT conclusions, the following definitions apply:

General terms	
Term used	Definition
Batch galvanising	Discontinuous immersion of steel workpieces in a bath containing molten zinc to coat their surface with zinc. This also includes any directly associated pre- and post-treatment processes (e.g. degreasing and passivation).
Bottom dross	A reaction product of molten zinc with iron or with iron salts carried over from pickling or fluxing. This reaction product sinks to the bottom of the zinc bath.
Carbon steel	Steel in which the content of each alloy element is less than 5 wt-%.
Channelled emissions	Emissions of pollutants into the environment through any kind of duct, pipe, stack, etc.
Cold rolling	Compression of steel by rollers at ambient temperatures to change its characteristics (e.g. size, shape and/or metallurgical properties). This also includes any directly associated pre- and post-treatment processes (e.g. pickling, annealing and oiling).
Continuous measurement	Measurement using an automated measuring system permanently installed on site.
Direct discharge	Discharge to a receiving water body without further downstream waste water treatment.
Existing plant	A plant that is not a new plant.
Feedstock	Any steel input (unprocessed or partly processed) or workpieces entering a production process step.
Feedstock heating	Any process step where feedstock is heated. This does not include feedstock drying or the heating of the galvanising kettle.
Ferrochromium	An alloy of chromium and iron typically containing between 50 wt-% and 70 wt-% chromium.
Flue-gas	The exhaust gas exiting a combustion unit.
High-alloy steel	Steel in which the content of one or more alloy elements is 5 wt-% or more.
Hot dip coating	Continuous immersion of steel sheets or wires through a bath containing molten metal(s), e.g. zinc and/or aluminium, to coat the surface with metal(s). This also includes any directly associated pre- and post-treatment processes (e.g. pickling and phosphating).
Hot rolling	Compression of heated steel by rollers at temperatures typically ranging from 1 050 °C to 1 300 °C to change its characteristics (e.g. size, shape and/or metallurgical properties). This includes hot ring rolling and hot rolling of seamless tubes as well as any directly associated pre- and post-treatment processes (e.g. scarfing, finishing, pickling and oiling).
Indirect discharge	A discharge that is not a direct discharge.
Intermediate heating	Heating of the feedstock between the hot rolling stages.
Iron and steel process gases	Blast furnace gas, basic oxygen furnace gas, coke oven gas or mixtures thereof originating from iron and steel production.
Leaded steel	Steel grades in which the content of lead added is typically between 0.15 wt-% and 0.35 wt-%.
Major upgrade plant	A major change in the design or technology of a plant with major adjustments or replacements of the process and/or abatement technique(s) and associated equipment.
Mass flow	The mass of a given substance or parameter which is emitted over a defined period of time.
Mill scale	Iron oxides formed on the surface of steel when oxygen reacts with hot metal. This occurs immediately after casting, during reheating and hot rolling.
Mixed acid	A mixture of hydrofluoric acid and nitric acid.
New plant	A plant first permitted at the site of the installation following the publication of these BAT conclusions or a complete replacement of a plant following the publication of these BAT conclusions.

Periodic measurement	Measurement at specified time intervals using manual or automated methods.
Plant	All parts of an installation covered by the scope of these BAT conclusions and any other directly associated activities which have an effect on consumption and/or emissions. Plants may be new plants or existing plants.
Post-heating	Heating of the feedstock after hot rolling.
Process chemicals	Substances and/or mixtures as defined in Article 3 of Regulation (EC) No 1907/2006 of the European Parliament and of the Council ⁽¹⁾ and used in the process(es).
Recovery	Recovery as defined in Article 3(15) of Directive 2008/98/EC of the European Parliament and of the Council ⁽²⁾ . The recovery of spent acids includes their regeneration, reclamation and recycling.
Regalvanising	The processing of used galvanised articles (e.g. highway guard rails) that are returned to be galvanised after long service periods. Processing of these articles requires additional process steps due to the presence of partly corroded surfaces or the need to remove any residual zinc coating.
Reheating	Heating of the feedstock before hot rolling.
Residue	Substance or object generated by the activities covered by the scope of these BAT conclusions as waste or by-product.
Sensitive receptor	Areas which need special protection, such as: - residential areas; - areas where human activities are carried out (e.g. neighbouring workplaces, schools, day-care centres, recreational areas, hospitals or nursing homes).
Stainless steel	High-alloy steel which contains chromium typically within the range 10-23 wt-%. It includes austenitic steel, which also contains nickel typically within the range 8-10 wt-%.
Top dross	In hot dipping, the oxides formed on the surface of the molten zinc bath by reaction of iron and aluminium.
Valid hourly (or half-hourly) average	An hourly (or half-hourly) average is considered valid when there is no maintenance or malfunction of the automated measuring system.
Volatile substance	A substance capable of readily changing from a solid or liquid form to a vapour, having a high vapour pressure and a low boiling point (e.g. HCl). This includes volatile organic compounds as defined in Article 3(45) of Directive 2010/75/EU.
Wire drawing	Drawing of steel rods or wires through dies to reduce their diameter. This also includes any directly associated pre- and post-treatment processes (e.g. wire rod pickling and feedstock heating after drawing).
Zinc ash	A mixture comprising zinc metal, zinc oxide and zinc chloride that is formed on the surface of the molten zinc bath.
<p>⁽¹⁾ Regulation (EC) No 1907/2006 of the European Parliament and of the Council of 18 December 2006 concerning the Registration, Evaluation, Authorisation and Restriction of Chemicals (REACH), establishing a European Chemicals Agency, amending Directive 1999/45/EC and repealing Council Regulation (EEC) No 793/93 and Commission Regulation (EC) No 1488/94 as well as Council Directive 76/769/EEC and Commission Directives 91/155/EEC, 93/67/EEC, 93/105/EC and 2000/21/EC (OJ L 396, 30.12.2006, p. 1).</p> <p>⁽²⁾ Directive 2008/98/EC of the European Parliament and of the Council of 19 November 2008 on waste and repealing certain Directives (OJ L 312, 22.11.2008, p. 3).</p>	

Pollutants and parameters	
Term used	Definition
B	The sum of boron and its compounds, dissolved or bound to particles, expressed as B.
Cd	The sum of cadmium and its compounds, dissolved or bound to particles, expressed as Cd.
CO	Carbon monoxide.
COD	Chemical oxygen demand. Amount of oxygen needed for the total chemical oxidation of the organic matter to carbon dioxide using dichromate. COD is an indicator for the mass concentration of organic compounds.
Cr	The sum of chromium and its compounds, dissolved or bound to particles, expressed as Cr.
Cr(VI)	Hexavalent chromium, expressed as Cr(VI), includes all chromium compounds where the chromium is in the oxidation state +6.
Dust	Total particulate matter (in air).
Fe	The sum of iron and its compounds, dissolved or bound to particles, expressed as Fe.
F ⁻	Dissolved fluoride, expressed as F ⁻ .
HCl	Hydrogen chloride.
HF	Hydrogen fluoride.
Hg	The sum of mercury and its compounds, dissolved or bound to particles, expressed as Hg.
HOI	Hydrocarbon oil index. The sum of compounds extractable with a hydrocarbon solvent (including long-chain or branched aliphatic, alicyclic, aromatic or alkyl-substituted aromatic hydrocarbons).
H ₂ SO ₄	Sulphuric acid.
NH ₃	Ammonia.
Ni	The sum of nickel and its compounds, dissolved or bound to particles, expressed as Ni.
NO _x	The sum of nitrogen monoxide (NO) and nitrogen dioxide (NO ₂), expressed as NO ₂ .
Pb	The sum of lead and its compounds, dissolved or bound to particles, expressed as Pb.
Sn	The sum of tin and its compounds, dissolved or bound to particles, expressed as Sn.
SO ₂	Sulphur dioxide.
SO _x	The sum of sulphur dioxide (SO ₂), sulphur trioxide (SO ₃) and sulphuric acid aerosols, expressed as SO ₂ .
TOC	Total organic carbon, expressed as C (in water); includes all organic compounds.
Total P	Total phosphorus, expressed as P, includes all inorganic and organic phosphorus compounds.
TSS	Total suspended solids. Mass concentration of all suspended solids (in water), measured via filtration through glass fibre filters and gravimetry.
TVOC	Total volatile organic carbon, expressed as C (in air).
Zn	The sum of zinc and its compounds, dissolved or bound to particles, expressed as Zn.

9.3 Acronyms

For the purposes of these BAT conclusions, the following acronyms apply:

Acronym	Definition
BG	Batch galvanising
CMS	Chemicals management system
CR	Cold rolling
EMS	Environmental management system
FMP	Ferrous metals processing
HDC	Hot dip coating
HR	Hot rolling
OTNOC	Other than normal operating conditions
SCR	Selective catalytic reduction
SNCR	Selective non-catalytic reduction
WD	Wire drawing

9.4 General considerations

9.4.1 Best Available Techniques

The techniques listed and described in these BAT conclusions are neither prescriptive nor exhaustive. Other techniques may be used that ensure at least an equivalent level of environmental protection.

Unless otherwise stated, the BAT conclusions are generally applicable.

9.4.2 BAT-AELs and indicative emission levels for emissions to air

Emission levels associated with the best available techniques (BAT-AELs) and indicative emission levels for emissions to air given in these BAT conclusions refer to concentrations (mass of emitted substances per volume of waste gas) under the following standard conditions: dry gas at a temperature of 273.15 K and a pressure of 101.3 kPa, and expressed in mg/Nm³.

The reference oxygen levels used to express BAT-AELs and indicative emission levels in these BAT conclusions are shown in the table below.

Source of emissions	Reference oxygen level (O _R)
Combustion processes associated with: <ul style="list-style-type: none"> - feedstock heating and drying; - heating of the galvanising kettle. 	3 dry vol-%
All other sources	No correction for the oxygen level

For the cases where a reference oxygen level is given, the equation for calculating the emission concentration at the reference oxygen level is:

$$E_R = \frac{21 - O_R}{21 - O_M} \times E_M$$

where: E_R: emission concentration at the reference oxygen level O_R;
 O_R: reference oxygen level in vol-%;
 E_M: measured emission concentration;
 O_M: measured oxygen level in vol-%.

The equation above does not apply if the combustion process(es) use oxygen-enriched air or pure oxygen or when additional air intake for safety reasons brings the oxygen level in the waste gas very close to 21 vol-%. In this case, the emission concentration at the reference oxygen level of 3 dry vol-% is calculated differently, e.g. by normalising on the basis of the carbon dioxide generated by the combustion.

For averaging periods of BAT-AELs for emissions to air, the following definitions apply.

Type of measurement	Averaging period	Definition
Continuous	Daily average	Average over a period of one day based on valid hourly or half-hourly averages.
Periodic	Average over the sampling period	Average value of three consecutive measurements of at least 30 minutes each ⁽¹⁾ .
⁽¹⁾ For any parameter where, due to sampling or analytical limitations and/or due to operational conditions, a 30-minute sampling/measurement and/or an average of three consecutive measurements is inappropriate, a more representative sampling/measurement procedure may be employed.		

When the waste gases of two or more sources (e.g. furnaces) are discharged through a common stack, the BAT-AELs apply to the combined discharge from the stack.

For the purpose of calculating the mass flows in relation to BAT 7 and BAT 20, where waste gases from one type of source (e.g. furnaces) discharged through two or more separate stacks could, in the judgement of the competent authority, be discharged through a common stack, these stacks shall be considered as a single stack.

9.4.3 BAT-AELs for emissions to water

Emission levels associated with the best available techniques (BAT-AELs) for emissions to water given in these BAT conclusions refer to concentrations (mass of emitted substances per volume of water), expressed in mg/l or µg/l.

Averaging periods associated with the BAT-AELs refer to either of the following two cases:

- In the case of continuous discharge, daily average values, i.e. 24-hour flow-proportional composite samples. Time-proportional composite samples can be used provided that sufficient flow stability is demonstrated. Spot samples can be used when the emission levels are proven to be sufficiently stable.
- In the case of batch discharge, average values over the release duration taken as flow-proportional composite samples, or, provided that the effluent is appropriately mixed and homogeneous, a spot sample taken before discharge.

The BAT-AELs apply at the point where the emission leaves the plant.

9.4.4 Other environmental performance levels associated with the best available techniques (BAT-AEPLs)

9.4.4.1 BAT-AEPLs for specific energy consumption (energy efficiency)

The BAT-AEPLs for specific energy consumption refer to yearly averages calculated using the following equation:

$$\text{specific energy consumption} = \frac{\text{energy consumption}}{\text{input}}$$

where:

energy consumption: total amount of heat (generated from primary energy sources) and electricity consumed by the relevant process(es), expressed in MJ/year or kWh/year; and

input: total amount of feedstock processed, expressed in t/year.

In the case of feedstock heating, the energy consumption corresponds to the total amount of heat (generated from primary energy sources) and electricity consumed by all furnaces in the relevant process(es).

9.4.4.2 BAT-AEPLs for specific water consumption

The BAT-AEPLs for specific water consumption refer to yearly averages calculated using the following equation:

$$\text{specific water consumption} = \frac{\text{water consumption}}{\text{production rate}}$$

where:

water consumption: total amount of water consumed by the plant excluding:

- recycled and reused water, and
- cooling water used in once-through cooling systems, and
- water for domestic-type usage,

expressed in m³/year; and,

production rate: total amount of products manufactured by the plant, expressed in t/year.

9.4.4.3 BAT-AEPLs for specific material consumption

The BAT-AEPLs for specific material consumption refer to averages over 3 years calculated using the following equation:

$$\text{specific material consumption} = \frac{\text{material consumption}}{\text{input}}$$

where:

material consumption: 3-year average of total amount of material consumed by the relevant process(es), expressed in kg/year; and

input: 3-year average of total amount of feedstock processed, expressed in t/year or m²/year.

9.5 General BAT conclusions for the ferrous metals processing industry

9.5.1 General environmental performance

BAT 1. In order to improve the overall environmental performance, BAT is to elaborate and implement an environmental management system (EMS) that incorporates all of the following features:

- i. commitment, leadership, and accountability of the management, including senior management, for the implementation of an effective EMS;
- ii. an analysis that includes the determination of the organisation's context, the identification of the needs and expectations of interested parties, the identification of characteristics of the installation that are associated with possible risks for the environment (or human health) as well as of the applicable legal requirements relating to the environment;
- iii. development of an environmental policy that includes the continuous improvement of the environmental performance of the installation;
- iv. establishing objectives and performance indicators in relation to significant environmental aspects, including safeguarding compliance with applicable legal requirements;
- v. planning and implementing the necessary procedures and actions (including corrective and preventive actions where needed), to achieve the environmental objectives and avoid environmental risks;
- vi. determination of structures, roles and responsibilities in relation to environmental aspects and objectives and provision of the financial and human resources needed;
- vii. ensuring the necessary competence and awareness of staff whose work may affect the environmental performance of the installation (e.g. by providing information and training);
- viii. internal and external communication;
- ix. fostering employee involvement in good environmental management practices;
- x. establishing and maintaining a management manual and written procedures to control activities with significant environmental impact as well as relevant records;
- xi. effective operational planning and process control;
- xii. implementation of appropriate maintenance programmes;
- xiii. emergency preparedness and response protocols, including the prevention and/or mitigation of the adverse (environmental) impacts of emergency situations;
- xiv. when (re)designing a (new) installation or a part thereof, consideration of its environmental impacts throughout its life, which includes construction, maintenance, operation and decommissioning;
- xv. implementation of a monitoring and measurement programme; if necessary, information can be found in the Reference Report on Monitoring of Emissions to Air and Water from IED Installations;
- xvi. application of sectoral benchmarking on a regular basis;
- xvii. periodic independent (as far as practicable) internal auditing and periodic independent external auditing in order to assess the environmental performance and to determine whether or not the EMS conforms to planned arrangements and has been properly implemented and maintained;
- xviii. evaluation of causes of nonconformities, implementation of corrective actions in response to nonconformities, review of the effectiveness of corrective actions, and determination of whether similar nonconformities exist or could potentially occur;
- xix. periodic review, by senior management, of the EMS and its continuing suitability, adequacy and effectiveness;
- xx. following and taking into account the development of cleaner techniques.

Specifically for the ferrous metals processing sector, BAT is to also incorporate the following features in the EMS:

- xxi. an inventory of process chemicals used and of waste water and waste gas streams (see BAT 2);
- xxii. a chemicals management system (see BAT 3);
- xxiii. a plan for the prevention and control of leaks and spillages (see BAT 4 (a));
- xxiv. an OTNOC management plan (see BAT 5);
- xxv. an energy efficiency plan (see BAT 10 (a));
- xxvi. a water management plan (see BAT 19 (a));
- xxvii. a noise and vibration management plan (see BAT 32);
- xxviii. a residues management plan (see BAT 34 (a)).

Note

Regulation (EC) No 1221/2009 establishes the European Union eco-management and audit scheme (EMAS), which is an example of an EMS consistent with this BAT.

Applicability

The level of detail and the degree of formalisation of the EMS will generally be related to the nature, scale and complexity of the installation, and the range of environmental impacts it may have.

BAT 2. In order to facilitate the reduction of emissions to water and air, BAT is to establish, maintain and regularly review (including when a significant change occurs) an inventory of process chemicals used and of waste water and waste gas streams, as part of the EMS (see BAT 1), that incorporates all of the following features:

- (i) information about the production processes, including:
 - (a) simplified process flow sheets that show the origin of the emissions;
 - (b) descriptions of process-integrated techniques and waste water/waste gas treatment at source including their performances;
- (ii) information about the characteristics of the waste water streams, such as:
 - (a) average values and variability of flow, pH, temperature and conductivity;
 - (b) average concentration and mass flow values of relevant substances (e.g. total suspended solids, TOC or COD, hydrocarbon oil index, phosphorus, metals, fluoride) and their variability;
- (iii) information about the quantity and characteristics of the process chemicals used:
 - (a) the identity and the characteristics of process chemicals, including properties with adverse effects on the environment and/or human health;
 - (b) the quantities of process chemicals used and the location of their use;
- (iv) information about the characteristics of the waste gas streams, such as:
 - (a) average values and variability of flow and temperature;
 - (b) average concentration and mass flow values of relevant substances (e.g. dust, NO_x, SO₂, CO, metals, acids) and their variability;
 - (c) presence of other substances that may affect the waste gas treatment system (e.g. oxygen, nitrogen, water vapour) or plant safety (e.g. hydrogen).

Applicability

The level of detail of the inventory will generally be related to the nature, scale and complexity of the plant, and the range of environmental impacts it may have.

BAT 3. In order to improve the overall environmental performance, BAT is to elaborate and implement a chemicals management system (CMS) as part of the EMS (see BAT 1) that incorporates all of the following features:

- i. A policy to reduce the consumption and risks of process chemicals, including a procurement policy to select less harmful process chemicals and their suppliers with the aim of minimising the use and risks of hazardous substances and avoiding the procurement of an excess amount of process chemicals. The selection of process chemicals may consider:
 - a) their eliminability, their ecotoxicity and their potential to be released into the environment in order to reduce emissions to the environment;
 - b) the characterisation of the risks associated with the process chemicals, based on the chemicals' hazards statement, pathways through the plant, potential release and level of exposure;
 - c) the regular (e.g. annual) analysis of the potential for substitution to identify potentially new available and safer alternatives to the use of hazardous substances (e.g. use of other process chemicals with no or lower environmental impacts, see BAT 9).
 - d) the anticipatory monitoring of regulatory changes related to hazardous chemicals and safeguarding compliance with applicable legal requirements.

The inventory of process chemicals (see BAT 2) may be used to support the selection of process chemicals.

- ii. Goals and action plans to avoid or reduce the use and risks of hazardous substances.
- iii. Development and implementation of procedures for the procurement, handling, storage, and use of process chemicals to prevent or reduce emissions to the environment (e.g. see BAT 4).

Applicability

The level of detail of the CMS will generally be related to the nature, scale and complexity of the plant.

BAT 4. In order to prevent or reduce emissions to soil and groundwater, BAT is to use all of the techniques given below.

	Technique	Description	Applicability
a.	Set-up and implementation of a plan for the prevention and control of leaks and spillages	<p>A plan for the prevention and control of leaks and spillages is part of the EMS (see BAT 1) and includes, but is not limited to:</p> <ul style="list-style-type: none"> – site incident plans for small and large spillages; – identification of the roles and responsibilities of persons involved; – ensuring staff are environmentally aware and trained to prevent and deal with spillage incidents; – identification of areas at risk of spillage and/or leaks of hazardous materials and ranking them according to the risk; – identification of suitable spillage containment and clean-up equipment and regularly ensuring it is available, in good working order and close to points where these incidents may occur; – waste management guidelines for dealing with waste arising from spillage control; – regular (at least on an annual basis) inspections of storage and handling areas, testing and calibration of leak detection equipment and prompt repair of leaks from valves, glands, flanges, etc. 	The level of detail of the plan will generally be related to the nature, scale and complexity of the plant, as well as to the type and quantity of liquids used.
b.	Use of oil-tight trays or cellars	Hydraulic stations and oil- or grease-lubricated equipment are situated in oil-tight trays or cellars.	Generally applicable.
c.	Prevention and handling of acid spillages and leaks	Storage tanks for both fresh and spent acid are equipped with sealed secondary containment protected with an acid-resistant coating which is regularly inspected for potential damage and cracks. Loading and unloading areas for the acids are designed in such a way that any potential spillages and leaks are contained and sent to on-site treatment (see BAT 31) or off-site treatment.	Generally applicable.

BAT 5. In order to reduce the frequency of the occurrence of OTNOC and to reduce emissions during OTNOC, BAT is to set up and implement a risk-based OTNOC management plan as part of the EMS (see BAT 1) that includes all of the following elements:

- i. identification of potential OTNOC (e.g. failure of equipment critical to the protection of the environment ('critical equipment')), of their root causes and of their potential consequences, and regular review and update of the list of identified OTNOC following the periodic assessment below;
- ii. appropriate design of critical equipment (e.g. compartmentalisation of fabric filters);
- iii. set-up and implementation of an inspection and preventive maintenance plan for critical equipment (see BAT 1 xii);
- iv. monitoring (i.e. estimating or, where possible, measuring) and recording of emissions during OTNOC and of associated circumstances;

- v. periodic assessment of the emissions occurring during OTNOC (e.g. frequency of events, duration, amount of pollutants emitted) and implementation of corrective actions if necessary.

9.5.2 Monitoring

BAT 6. BAT is to monitor at least once per year:

- the yearly consumption of water, energy and materials;
- the yearly generation of waste water;
- the yearly amount of each type of residues generated and of each type of waste sent for disposal.

Description

Monitoring can be performed by direct measurements, calculations or recording, e.g. using suitable meters or invoices. The monitoring is broken down to the most appropriate level (e.g. to process or plant level) and considers any significant changes in the plant.

BAT 7. BAT is to monitor channelled emissions to air with at least the frequency given below and in accordance with EN standards. If EN standards are not available, BAT is to use ISO, national or other international standards that ensure the provision of data of an equivalent scientific quality.

Substance/ Parameter	Specific process(es)	Sector	Standard(s)	Minimum monitoring frequency ⁽¹⁾	Monitoring associated with
CO	Feedstock heating ⁽²⁾	HR, CR, WD, HDC	EN 15058 ⁽³⁾	Once every year	BAT 22
	Heating of the galvanising kettle ⁽²⁾	HDC of wires, BG		Once every year	
	Hydrochloric acid recovery by spray roasting or by using fluidised bed reactors	HR, CR, HDC, WD		Once every year	BAT 29
	Mixed acid recovery by spray roasting				

Dust	Feedstock heating	HR, CR, WD, HDC	EN 13284-1 ⁽³⁾ ⁽⁴⁾	Continuous for any stack with dust mass flows > 2 kg/h Once every 6 months for any stack with dust mass flows between 0.1 kg/h and 2 kg/h Once every year for any stack with dust mass flows < 0.1 kg/h	BAT 20
	Hot dipping after fluxing	HDC, BG		Once every year ⁽⁵⁾	BAT 26
	Hydrochloric acid recovery by spray roasting or by using fluidised bed reactors Mixed acid recovery by spray roasting or by evaporation	HR, CR, HDC, WD		Once every year	BAT 29
	Mechanical processing (including slitting, descaling, grinding, roughing, rolling, finishing, levelling), scarfing (other than manual scarfing) and welding	HR		Once every year	BAT 42
	Decoiling, mechanical predescaling, levelling and welding	CR		Once every year	BAT 46
	Lead baths	WD		Once every year	BAT 51
	Dry drawing			Once every year	BAT 52
	HCl	Pickling with hydrochloric acid		HR, CR, HDC, WD	EN 1911 ⁽³⁾
Pickling and stripping with hydrochloric acid		BG	Once every year	BAT 62	
Hydrochloric acid recovery by spray roasting or by using fluidised bed reactors		HR, CR, HDC, WD	Once every year	BAT 29	

	Pickling and stripping with hydrochloric acid in open pickling baths	BG	No EN standard available	Once every year ⁽⁶⁾	BAT 62	
HF	Pickling with acid mixtures containing hydrofluoric acid	HR, CR, HDC	EN standard under development ⁽³⁾	Once every year	BAT 24	
	Recovery of mixed acid by spray roasting or by evaporation	HR, CR		Once every year	BAT 29	
Metals	Ni	Mechanical processing (including slitting, descaling, grinding, roughing, rolling, finishing, levelling), scarfing (other than manual scarfing) and welding	EN 14385	Once every year ⁽⁷⁾	BAT 42	
		Decoiling, mechanical predescaling, levelling and welding		Once every year ⁽⁷⁾	BAT 46	
	Pb	Mechanical processing (including slitting, descaling, grinding, roughing, rolling, finishing, levelling), scarfing (other than manual scarfing) and welding		Once every year ⁽⁷⁾	BAT 42	
		Decoiling, mechanical predescaling, levelling and welding		Once every year ⁽⁷⁾	BAT 46	
	Zn	Lead baths		WD	Once every year	BAT 51
		Hot dipping after fluxing		HDC, BG	Once every year ⁽⁵⁾	BAT 26
NH ₃	When SNCR and/or SCR is used	HR, CR, WD, HDC	EN ISO 21877 ⁽³⁾	Once every year	BAT 22, BAT 25, BAT 29	
NO _x	Feedstock heating ⁽²⁾	HR, CR, WD, HDC	EN 14792 ⁽³⁾	Continuous for any stack with NO _x mass flows > 15 kg/h Once every 6 months for any stack with NO _x mass flows between 1 kg/h and 15 kg/h Once every year for any stack with NO _x mass flows < 1 kg/h	BAT 22	

	Heating of the galvanising kettle-(²)	HDC of wires, BG		Once every year	
	Pickling with nitric acid alone or in combination with other acids	HR, CR		Once every year	BAT 25
	Hydrochloric acid recovery by spray roasting or by using fluidised bed reactors	HR, CR, WD, HDC		Once every year	BAT 29
	Mixed acid recovery by spray roasting or by evaporation				
SO ₂	Feedstock heating (⁸)	HR, CR, WD, coating of sheets in HDC	EN 14791 (³)	Continuous for any stack with SO ₂ mass flows > 10 kg/h	BAT 21
				Once every 6 months for any stack with SO ₂ mass flows between 1 kg/h and 10 kg/h	
	Hydrochloric acid recovery by spray roasting or by using fluidised bed reactors	HR, CR, HDC, WD		Once every year (⁵)	BAT 29
SO _x	Pickling with sulphuric acid	HR, CR, HDC, WD BG		Once every year	BAT 24
TVOC	Degreasing	CR, HDC	EN 12619 (³)	Once every year (⁵)	BAT 23
	Rolling, wet tempering and finishing	CR		Once every year (⁵)	BAT 48
	Lead baths	WD		Once every year (⁵)	—
	Oil quench baths	WD		Once every year (⁵)	BAT 53

(¹) To the extent possible, the measurements are carried out at the highest expected emission state under normal operating conditions.

(²) The monitoring does not apply when only electricity is used.

(³) If measurements are continuous, the following generic EN standards apply: EN 15267-1, EN 15267-2, EN 15267-3 and EN 14181.

(⁴) If measurements are continuous, EN 13284-2 also applies.

(⁵) If the emission levels are proven to be sufficiently stable, a lower monitoring frequency can be adopted but in any case at least once every 3 years.

(⁶) In the event that techniques (a) or (b) of BAT 62 are not applicable, measurement of the HCl concentration in the gaseous phase above the pickling bath is carried out at least once every year.

(⁷) The monitoring only applies when the substance concerned is identified as relevant in the waste gas stream based on the inventory given in BAT 2.

(⁸) The monitoring does not apply if only natural gas is used as a fuel or when only electricity is used.

BAT 8. BAT is to monitor emissions to water with at least the frequency given below and in accordance with EN standards. If EN standards are not available, BAT is to use ISO, national or other international standards that ensure the provision of data of an equivalent scientific quality.

Substance/Parameter		Specific process(es)	Standard(s)	Minimum monitoring frequency ⁽¹⁾	Monitoring associated with
Total suspended solids (TSS) ⁽²⁾		All processes	EN 872	Once every week ⁽³⁾	BAT 31
Total organic carbon (TOC) ⁽²⁾ ⁽⁴⁾		All processes	EN 1484	Once every month	
Chemical oxygen demand (COD) ⁽²⁾ ⁽⁴⁾		All processes	No EN standard available		
Hydrocarbon oil index (HOI) ⁽⁵⁾		All processes	EN ISO 9377-2	Once every month	
Metals/ metalloids ⁽⁵⁾	Boron	Processes where borax is used	Various EN standards available (e.g. EN ISO 11885, EN ISO 17294-2)	Once every month	
	Cadmium	All processes ⁽⁶⁾	Various EN standards available (e.g. EN ISO 11885, EN ISO 15586, EN ISO 17294-2)	Once every month	
	Chromium	All processes ⁽⁶⁾			
	Iron	All processes			
	Nickel	All processes ⁽⁶⁾			
	Lead	All processes ⁽⁶⁾			
	Tin	Hot dip coating using tin			
	Zinc	All processes ⁽⁶⁾			
	Mercury	All processes ⁽⁶⁾			Various EN standards available (e.g. EN ISO 12846, EN ISO 17852)
Hexavalent chromium	Pickling of high-alloy steel or passivation with hexavalent chromium compounds	Various EN standards available (e.g. EN ISO 10304-3, EN ISO 23913)			
Total phosphorus (Total P) ⁽²⁾		Phosphating	Various EN standards available (e.g. EN ISO 6878, EN ISO 11885, EN ISO 15681-1 and -2)	Once every month	
Fluoride (F ⁻) ⁽⁵⁾		Pickling with acid mixtures containing hydrofluoric acid	EN ISO 10304-1	Once every month	

⁽¹⁾ In the case of batch discharge less frequent than the minimum monitoring frequency, monitoring is carried out once per batch.

⁽²⁾ The monitoring only applies in the case of a direct discharge to a receiving water body.

⁽³⁾ Monitoring frequencies may be reduced to once every month if the emission levels are proven to be sufficiently stable.

⁽⁴⁾ Either COD or TOC is monitored. TOC monitoring is the preferred option because it does not rely on the use of very toxic compounds.

- (⁵) In the case of an indirect discharge to a receiving water body, the monitoring frequency may be reduced to once every 3 months if the downstream waste water treatment plant is designed and equipped appropriately to abate the pollutants concerned.
- (⁶) The monitoring only applies when the substance/parameter is identified as relevant in the waste water stream based on the inventory mentioned in BAT 2.

9.5.3 Hazardous substances

BAT 9. In order to avoid the use of hexavalent chromium compounds in passivation, BAT is to use other metal-containing solutions (e.g. containing manganese, zinc, titanium fluoride, phosphates and/or molybdates) or organic polymer solutions (e.g. containing polyurethanes or polyesters).

Applicability

Applicability may be restricted due to product specifications (e.g. surface quality, paintability, weldability, formability, corrosion resistance).

9.5.4 Energy efficiency

BAT 10. In order to increase the overall energy efficiency of the plant, BAT is to use both of the techniques given below.

Technique	Description	Applicability
a. Energy efficiency plan and energy audits	<p>An energy efficiency plan is part of the EMS (see BAT 1) and entails defining and monitoring the specific energy consumption of the activity/processes (see BAT 6), setting key performance indicators on an annual basis (e.g. MJ/t of product) and planning the periodic improvement targets and related actions.</p> <p>Energy audits are carried out at least once a year to ensure that the objectives of the energy management plan are met.</p> <p>The energy efficiency plan and the energy audits may be integrated in the overall energy efficiency plan of a larger installation (e.g. for iron and steel production).</p>	<p>The level of detail of the energy efficiency plan, of the energy audits and of the energy balance record will generally be related to the nature, scale and complexity of the plant and the types of energy sources used.</p>
b. Energy balance record	<p>Drawing up on an annual basis of an energy balance record which provides a breakdown of the energy consumption and generation (including energy export) by the type of energy source (e.g. electricity, natural gas, iron and steel process gases, renewable energy, imported heat and/or cooling). This includes:</p> <ul style="list-style-type: none"> - defining the energy boundary of the processes; - information on energy consumption in terms of delivered energy; - information on energy exported from the plant; - energy flow information (e.g. Sankey diagrams or energy balances) showing how the energy is used throughout the processes. 	

BAT 11. In order to increase energy efficiency in heating (including heating and drying of feedstock as well as heating of baths and galvanising kettles), BAT is to use an appropriate combination of the techniques given below.

Technique	Description	Applicability	
<i>Design and operation</i>			
a.	Optimum furnace design for feedstock heating	This includes techniques such as: <ul style="list-style-type: none"> – optimisation of key furnace characteristics (e.g. number and type of burners, air tightness and furnace insulation using suitable refractory materials); – minimisation of heat losses from furnace door openings, e.g. by using several liftable segments instead of one in continuous reheating furnaces; – minimisation of the number of feedstock-supporting structures inside the furnace (e.g. beams, skids) and use of suitable insulation to reduce the heat losses from water cooling of the supporting structures in continuous reheating furnaces. 	Only applicable to new plants and major plant upgrades.
b.	Optimum galvanising kettle design	This includes techniques such as: <ul style="list-style-type: none"> – uniform heating of the galvanising kettle walls (e.g. by using high-velocity burners or radiant design); – minimisation of heat losses from the furnace using insulated outer/inner walls (e.g. ceramic lining). 	Only applicable to new plants and major plant upgrades.
c.	Optimum galvanising kettle operation	This includes techniques such as: <ul style="list-style-type: none"> – minimisation of heat losses from the galvanising kettle in hot dip coating of wires or in batch galvanising, e.g. by using insulated covers during idle periods. 	Generally applicable.
d.	Combustion optimisation	See Section 9.11.1.	Generally applicable.
e.	Furnace automation and control	See Section 9.11.1.	Generally applicable.
f.	Process gas management system	See Section 9.11.1. The calorific value of iron and steel process gases and/or CO-rich gas from ferrochromium production is used.	Only applicable when iron and steel process gases and/or CO-rich gas from ferrochromium production are available.
g.	Batch annealing with 100 % hydrogen	Batch annealing is carried out in furnaces using 100 % hydrogen as a protective gas with increased thermal conductivity.	Only applicable to new plants and major plant upgrades.
h.	Oxy-fuel combustion	See Section 9.11.1.	Applicability may be restricted for furnaces processing high-alloy steel. Applicability to existing plants may be restricted by furnace design and the need for a minimum waste gas flow. Not applicable to furnaces equipped with radiant tube burners.

i.	Flameless combustion	See Section 9.11.1.	<p>Applicability to existing plants may be limited by furnace design (i.e. furnace volume, space for burners, distance between burners) and the need for a change of the refractory lining.</p> <p>Applicability may be limited for processes where close control of temperature or temperature profile is required (e.g. recrystallisation).</p> <p>Not applicable to furnaces operating at a temperature lower than the auto-ignition temperature required for flameless combustion or to furnaces equipped with radiant tube burners.</p>
j.	Pulse-fired burner	The heat input to the furnace is controlled by the firing duration of the burners or by the sequential start of the individual burners instead of adjusting combustion air and fuel flows.	Only applicable to new plants and major plant upgrades.
<i>Heat recovery from flue-gases</i>			
k.	Feedstock preheating	Feedstock is preheated by blowing hot flue-gases directly onto it.	Only applicable to continuous reheating furnaces. Not applicable to furnaces equipped with radiant tube burners.
l.	Drying of workpieces	In batch galvanising, the heat from flue-gases is used to dry the workpieces.	Generally applicable.
m.	Preheating of combustion air	See Section 9.11.1. This may be achieved for example by using regenerative or recuperative burners. A balance has to be achieved between maximising heat recovery from the flue-gas and minimising NO _x emissions.	Applicability to existing plants may be restricted by a lack of space for the installation of regenerative burners.
n.	Waste heat recovery boiler	The heat from hot flue-gases is used to generate steam or hot water that is used in other processes (e.g. for heating pickling and fluxing baths), for district heating or for generating electricity.	Applicability to existing plants may be restricted by a lack of space and/or a suitable steam or hot water demand.

Further sector-specific techniques to increase energy efficiency are given in Sections 9.6.1, 9.7.1 and 9.8.1 of these BAT conclusions.

Table 9.1: BAT-associated environmental performance levels (BAT-AEPLs) for specific energy consumption for feedstock heating in hot rolling

Specific process(es) <i>Steel products at the end of the rolling process</i>	Unit	BAT-AEPL (Yearly average)
Feedstock reheating		
<i>Hot rolled coils (strips)</i>	MJ/t	1 200-1 500 ⁽¹⁾
<i>Heavy plates</i>	MJ/t	1 400-2 000 ⁽²⁾
<i>Bars, rods</i>	MJ/t	600-1 900 ⁽²⁾
<i>Beams, billets, rails, tubes</i>	MJ/t	1 400-2 200
Feedstock intermediate heating		
<i>Bars, rods, tubes</i>	MJ/t	100-900
Feedstock post-heating		
<i>Heavy plates</i>	MJ/t	1 000-2 000
<i>Bars, rods</i>	MJ/t	1 400-3 000 ⁽³⁾
⁽¹⁾ In the case of high-alloy steel (e.g. austenitic stainless steel), the higher end of the BAT-AEPL range may be higher and up to 2 200 MJ/t. ⁽²⁾ In the case of high-alloy steel (e.g. austenitic stainless steel), the higher end of the BAT-AEPL range may be higher and up to 2 800 MJ/t. ⁽³⁾ In the case of high-alloy steel (e.g. austenitic stainless steel), the higher end of the BAT-AEPL range may be higher and up to 4 000 MJ/t.		

Table 9.2: BAT-associated environmental performance level (BAT-AEPL) for specific energy consumption in annealing after cold rolling

Specific process(es)	Unit	BAT-AEPL (Yearly average)
Annealing after cold rolling (batch and continuous)	MJ/t	600-1 200 ⁽¹⁾ ⁽²⁾
⁽¹⁾ For batch annealing, the lower end of the BAT-AEPL range can be achieved by using BAT 11 (g). ⁽²⁾ The BAT-AEPL may be higher for continuous annealing lines requiring an annealing temperature above 800 °C.		

Table 9.3: BAT-associated environmental performance level (BAT-AEPL) for specific energy consumption of feedstock heating before hot dip coating

Specific process(es)	Unit	BAT-AEPL (Yearly average)
Feedstock heating before hot dip coating	MJ/t	700-1 100 ⁽¹⁾
⁽¹⁾ The BAT-AEPL may be higher for continuous annealing lines requiring an annealing temperature above 800 °C.		

Table 9.4: BAT-associated environmental performance level (BAT-AEPL) for specific energy consumption in batch galvanising

Specific process(es)	Unit	BAT-AEPL (Yearly average)
Batch galvanising	kWh/t	300-800 ⁽¹⁾ ⁽²⁾ ⁽³⁾
⁽¹⁾ The higher end of the BAT-AEPL range may be higher when centrifugation is used to remove the excess zinc and/or when the galvanising bath temperature is higher than 500 °C. ⁽²⁾ The higher end of the BAT-AEPL may be higher and up to 1 200 kWh/t for batch galvanising plants operating at an average yearly production throughput below 150 t/m ³ of kettle volume. ⁽³⁾ In the case of batch galvanising plants producing mainly thin products (e.g. < 1.5 mm), the higher end of the BAT-AEPL range may be higher and up to 1 000 kWh/t.		

The associated monitoring is given in BAT 6.

9.5.5 Material efficiency

BAT 12. In order to increase material efficiency in degreasing and to reduce the generation of spent degreasing solution, BAT is to use a combination of the techniques given below.

Technique		Description	Applicability
<i>Avoiding or reducing the need for degreasing</i>			
a.	Use of feedstock with low oil and grease contamination	The use of feedstock with low oil and grease contamination prolongs the lifetime of the degreasing solution.	Applicability may be limited if the feedstock quality cannot be influenced.
b.	Use of a direct-flame furnace in the case of hot dip coating of sheets	The oil on the surface of the sheet is burnt in a direct-flame furnace. Degreasing before the furnace may be needed for some high-quality products or in the case of sheets with high residual oil levels.	Applicability may be limited if a very high level of surface cleanliness and zinc adhesion is required.
<i>Degreasing optimisation</i>			
c.	General techniques for increased degreasing efficiency	These include techniques such as: <ul style="list-style-type: none"> – monitoring and optimising the temperature and the concentration of degreasing agents in the degreasing solution; – enhancing the effect of the degreasing solution on the feedstock (e.g. by moving the feedstock, agitating the degreasing solution or by using ultrasound to create cavitation of the solution on the surface to be degreased). 	Generally applicable.
d.	Minimisation of drag-out of degreasing solution	This includes techniques such as: <ul style="list-style-type: none"> – using squeeze rolls, e.g. in the case of continuous degreasing of strip; – allowing for a sufficient dripping time, e.g. by slow lifting of workpieces. 	Generally applicable.
e.	Reverse cascade degreasing	Degreasing is carried out in two or more baths in series where the feedstock is moved from the most contaminated degreasing bath to the cleanest.	Generally applicable.
<i>Extending the lifetime of the degreasing baths</i>			
f.	Cleaning and reuse of the degreasing solution	Magnetic separation, oil separation (e.g. skimmers, discharge launders, weirs), micro- or ultrafiltration or biological treatment is used to clean the degreasing solution for reuse.	Generally applicable.

BAT 13. In order to increase material efficiency in pickling and to reduce the generation of spent pickling acid when pickling acid is heated, BAT is to use one of the techniques given below and not to use direct injection of steam.

Technique		Description
a.	Acid heating with heat exchangers	Corrosion-resistant heat exchangers are immersed in the pickling acid for indirect heating, e.g. with steam.
b.	Acid heating by submerged combustion	Combustion gases pass through the pickling acid, releasing the energy via direct heat transfer.

BAT 14. In order to increase material efficiency in pickling and to reduce the generation of spent pickling acid, BAT is to use an appropriate combination of the techniques given below.

Technique		Description	Applicability
<i>Avoiding or reducing the need for pickling</i>			
a.	Minimisation of steel corrosion	This includes techniques such as: <ul style="list-style-type: none"> – cooling the hot rolled steel as fast as possible depending on product specifications; – storing the feedstock in roofed areas; – limiting the storage duration of the feedstock. 	Generally applicable.
b.	Mechanical (pre)descaling	This includes techniques such as: <ul style="list-style-type: none"> – shot blasting; – bending; – sanding; – brushing; – stretching and levelling. 	Applicability to existing plants may be restricted by a lack of space. Applicability may be restricted due to product specifications.
c.	Electrolytic prepickling of high-alloy steel	Use of an aqueous solution of sodium sulphate (Na_2SO_4) to pretreat high-alloy steel before pickling with mixed acid, in order to speed up and improve the removal of the surface oxide scale. The waste water containing hexavalent chromium is treated using technique BAT 31 (f).	Only applicable to cold rolling. Applicability to existing plants may be restricted by a lack of space.
<i>Pickling optimisation</i>			
d.	Rinsing after alkaline degreasing	Carry-over of alkaline degreasing solution to the pickling bath is reduced by rinsing feedstock after degreasing.	Applicability to existing plants may be restricted by a lack of space.
e.	General techniques for increased pickling efficiency	These include techniques such as: <ul style="list-style-type: none"> – optimisation of the pickling temperature for maximising pickling rates while minimising emissions of acids; – optimisation of the pickling bath composition (e.g. acid and iron concentrations); – optimisation of the pickling time to avoid over-pickling; – avoiding drastic changes in the pickling bath composition by frequently replenishing it with fresh acid. 	Generally applicable.
f.	Cleaning of the pickling bath and reuse of free acid	A cleaning circuit, e.g. with filtration, is used to remove particles from the pickling acid followed by reclamation of the free acid via ion	Not applicable if cascade pickling (or similar) is used, as

		exchange, e.g. using resins.	this results in very low levels of free acid.
g.	Reverse cascade pickling	Pickling is carried out in two or more baths in series where the feedstock is moved from the bath with the lowest acid concentration to the one with the highest.	Applicability to existing plants may be restricted by a lack of space.
h.	Minimisation of drag-out of pickling acid	This includes techniques such as: <ul style="list-style-type: none"> – using squeeze rolls, e.g. in the case of continuous pickling of strip; – allowing for a sufficient dripping time, e.g. by slow lifting of workpieces; – using vibrating wire rod coils. 	Generally applicable.
i.	Turbulence pickling	This includes techniques such as: <ul style="list-style-type: none"> – injection of the pickling acid at high pressure via nozzles; – agitation of the pickling acid using an immersed turbine. 	Applicability to existing plants may be restricted by a lack of space.
j.	Use of pickling inhibitors	Pickling inhibitors are added to the pickling acid to protect metallurgically clean parts of the feedstock from over-pickling.	Not applicable to high-alloy steel. Applicability may be restricted due to product specifications.
k.	Activated pickling in hydrochloric acid pickling	Pickling is carried out with a low hydrochloric acid concentration (i.e. around 4-6 wt-%) and a high iron concentration (i.e. around 120-180 g/l) at temperatures of 20-25°C.	Generally applicable.

Table 9.5: BAT- associated environmental performance level (BAT-AEPL) for specific pickling acid consumption in batch galvanising

Pickling acid	Unit	BAT-AEPL (3-year average)
Hydrochloric acid, 28 wt-%	kg/t	13-30 ⁽¹⁾
⁽¹⁾ The higher end of the BAT-AEPL range may be higher and up to 50 kg/t when galvanising mainly workpieces with a high specific surface area (e.g. thin products < 1.5 mm, tubes with a wall thickness < 3 mm) or when reglavanising is carried out.		

The associated monitoring is given in BAT 6.

BAT 15. In order to increase material efficiency in fluxing and to reduce the quantity of spent fluxing solution sent for disposal, BAT is use all of the techniques (a), (b) and (c), in combination with technique (d) or in combination with technique (e) given below.

Technique		Description	Applicability
a.	Rinsing of workpieces after pickling	In batch galvanising, carry-over of iron to the fluxing solution is reduced by rinsing workpieces after pickling.	Applicability to existing plants may be restricted by a lack of space.
b.	Optimised fluxing operation	The chemical composition of the fluxing solution is monitored and adjusted frequently. The amount of fluxing agent used is reduced to the minimum level required to achieve the product specifications.	Generally applicable.
c.	Minimisation of drag-out of fluxing solution	The drag-out of the fluxing solution is minimised by allowing enough time for it to drip off.	Generally applicable.
d.	Iron removal and reuse of the fluxing solution	Iron is removed from the fluxing solution by one of the following techniques: <ul style="list-style-type: none"> - electrolytic oxidation; - oxidation using air or H₂O₂; - ion exchange. After iron removal, the fluxing solution is reused.	Applicability to existing batch galvanising plants may be restricted by a lack of space.
e.	Recovery of salts from the spent fluxing solution for production of fluxing agents	Spent fluxing solution is used to recover the salts contained therein to produce fluxing agents. This may take place on site or off site.	Applicability may be restricted depending on the availability of a market.

BAT 16. In order to increase the material efficiency of hot dipping in the coating of wires and in batch galvanising, and to reduce the generation of waste, BAT is to use all of the techniques given below.

Technique		Description
a.	Reduction of the generation of bottom dross	The generation of bottom dross is reduced, e.g. by sufficient rinsing after pickling, removing the iron from the fluxing solution (see BAT 15 (d)), using fluxing agents with a mild pickling effect and avoiding local overheating in the galvanising kettle.
b.	Prevention, collection and reuse of zinc splashes in batch galvanising	The generation of zinc splashes from the galvanising kettle is reduced by minimising carry-over of the fluxing solution (see BAT 26 (b)). Zinc splashes out of the kettle are collected and reused. The area surrounding the kettle is kept clean to reduce contamination of the splashes.
c.	Reduction of the generation of zinc ash	The formation of zinc ash, i.e. zinc oxidation on the bath surface, is reduced for example by: <ul style="list-style-type: none"> - sufficient drying of the workpieces/wires before dipping; - avoiding unnecessary disturbances of the bath during production, including during skimming; - in continuous hot dipping of wires, reducing the bath surface that is in contact with air using a floating refractory cover.

BAT 17. In order to increase material efficiency and to reduce the quantity of waste sent for disposal from phosphating and passivation, BAT is to use technique (a) and one of the techniques (b) or (c) given below.

Technique		Description
<i>Extending the lifetime of the treatment baths</i>		
a.	Cleaning and reuse of the phosphating or passivation solution	A cleaning circuit, for example with filtration, is used to clean the phosphating or passivation solution for reuse.
<i>Treatment optimisation</i>		
b.	Use of roll coaters for strips	Roll coaters are used to apply a passivation or a phosphate-containing layer on the surface of strips. This allows better control of the layer thickness and thus the reduction of the consumption of chemicals.
c.	Minimisation of drag-out of chemical solution	The drag-out of chemical solution is minimised, e.g. by passing the strips through squeeze rolls or by allowing for sufficient dripping time for workpieces.

BAT 18. In order to reduce the quantity of spent pickling acid sent for disposal, BAT is to recover spent pickling acids (i.e. hydrochloric acid, sulphuric acid and mixed acid). The neutralisation of spent pickling acids or the use of spent pickling acids for emulsion splitting is not BAT.

Description

Techniques to recover spent pickling acid on site or off site, include:

- i. spray roasting or using fluidised bed reactors for the recovery of hydrochloric acid;
- ii. crystallisation of ferric sulphate for the recovery of sulphuric acid;
- iii. spray roasting, evaporation, ion exchange or diffusion dialysis, for the recovery of mixed acid;
- iv. use of spent pickling acid as a secondary raw material (e.g. for the production of iron chloride or pigments).

Applicability

In batch galvanising, if the use of spent pickling acid as a secondary raw material is restricted by market unavailability, neutralisation of spent pickling acid may exceptionally take place.

Further sector-specific techniques to increase material efficiency are given in Sections 9.6.2, 9.7.2, 9.8.2, 9.9.1 and 9.10.1 of these BAT conclusions.

9.5.6 Water use and waste water generation

BAT 19. In order to optimise water consumption, to improve water recyclability and to reduce the volume of waste water generated, BAT is to use both techniques (a) and (b) and an appropriate combination of the techniques (c) to (h) given below.

Technique	Description	Applicability
a.	<p>Water management plan and water audits</p> <p>A water management plan and water audits are part of the EMS (see BAT 1) and include:</p> <ul style="list-style-type: none"> – flow diagrams and a water mass balance of the plant; – establishment of water efficiency objectives; – implementation of water optimisation techniques (e.g. control of water usage, water recycling, detection and repair of leaks). <p>Water audits are carried out at least once every year to ensure that the objectives of the water management plan are met.</p> <p>The water management plan and the water audits may be integrated in the overall water management plan of a larger installation (e.g. for iron and steel production).</p>	<p>The level of detail of the water management plan and water audits will generally be related to the nature, scale and complexity of the plant.</p>
b.	<p>Segregation of water streams</p> <p>Each water stream (e.g. surface run-off water, process water, alkaline or acidic waste water, spent degreasing solution) is collected separately, based on the pollutant content and on the required treatment techniques. Waste water streams that can be recycled without treatment are segregated from waste water streams that require treatment.</p>	<p>Applicability to existing plants may be limited by the layout of the water collection system.</p>
c.	<p>Minimisation of hydrocarbon contamination of process water</p> <p>The contamination of process water by oil and lubricant losses is minimised by using techniques such as:</p> <ul style="list-style-type: none"> – oil-tight bearings and bearing seals for working rolls; – leakage indicators; – regular inspections and preventive maintenance of pump seals, piping and working rolls. 	<p>Generally applicable.</p>
d.	<p>Reuse and/or recycling of water</p> <p>Water streams (e.g. process water, effluents from wet scrubbing or quench baths) are reused and/or recycled in closed or semi-closed circuits, if necessary after treatment (see BAT 30 and BAT 31).</p>	<p>The degree of water reuse and/or recycling is limited by the water balance of the plant, the content of impurities and/or the characteristics of the water streams.</p>
e.	<p>Reverse cascade rinsing</p> <p>Rinsing is carried out in two or more baths in series where the feedstock is moved from the most contaminated rinsing bath to the cleanest.</p>	<p>Applicability to existing plants may be restricted by a lack of space.</p>
f.	<p>Recycling or reuse of rinsing water</p> <p>Water from rinsing after pickling or degreasing is recycled/reused, if necessary after treatment, to the preceding process baths as make-up</p>	<p>Generally applicable.</p>

		water, rinsing water or, if the acid concentration is sufficiently high, for acid recovery.	
g.	Treatment and reuse of oil- and scale-bearing process water in hot rolling	Oil- and scale-bearing waste water from hot rolling mills is treated separately using different cleaning steps including scale pits, settling tanks, cyclones and filtration to separate oil and scale. A large proportion of the treated water is reused in the process.	Generally applicable.
h.	Water spray descaling triggered by sensors in hot rolling	Sensors and automation are used to track the position of the feedstock and adjust the volume of the descaling water passing through the water sprays.	Generally applicable.

Table 9.6: BAT-associated environmental performance levels (BAT-AEPLs) for specific water consumption

Sector	Unit	BAT-AEPL (Yearly average)
Hot rolling	m ³ /t	0.5–5
Cold rolling	m ³ /t	0.5–10
Wire drawing	m ³ /t	0.5–5
Hot dip coating	m ³ /t	0.5–5

The associated monitoring is given in BAT 6.

9.5.7 Emissions to air

9.5.7.1 Emissions to air from heating

BAT 20. In order to prevent or reduce dust emissions to air from heating, BAT is to use either electricity generated from fossil-free energy sources or technique (a), in combination with technique (b) given below.

Technique	Description	Applicability
a. Use of fuels with low dust and ash content	Fuels with low dust and ash content include for example natural gas, liquefied petroleum gas, dedusted blast furnace gas and dedusted basic oxygen furnace gas.	Generally applicable.
b. Limiting the entrainment of dust	Entrainment of dust is limited by for example: <ul style="list-style-type: none"> - as far as practically possible, use of clean feedstock or cleaning the feedstock of loose scale and dust before feeding it into the furnace; - minimisation of dust generation from refractory lining damage, e.g. by avoiding direct contact of the flames with the refractory lining, using ceramic coatings on the refractory lining; - avoiding direct contact of the flames with the feedstock. 	Avoiding direct contact of the flames with the feedstock is not applicable in the case of direct flame furnaces.

Table 9.7: BAT-associated emission levels (BAT-AELs) for channelled dust emissions to air from feedstock heating

Parameter	Sector	Unit	BAT-AEL ⁽¹⁾ (Daily average or average over the sampling period)
Dust	Hot rolling	mg/Nm ³	< 2–10
	Cold rolling		< 2–10
	Wire drawing		< 2–10
	Hot dip coating		< 2–10
⁽¹⁾ The BAT-AEL does not apply when the dust mass flow is below 100 g/h.			

The associated monitoring is given in BAT 7.

BAT 21. In order to prevent or reduce SO₂ emissions to air from heating, BAT is to use either electricity generated from fossil-free energy sources or a fuel, or a combination of fuels, with low sulphur content.

Description

Fuels with low sulphur content include for example natural gas, liquefied petroleum gas, blast furnace gas, basic oxygen furnace gas and CO-rich gas from ferrochromium production.

Table 9.8: BAT-associated emission levels (BAT-AELs) for channelled SO₂ emissions to air from feedstock heating

Parameter	Sector	Unit	BAT-AEL (Daily average or average over the sampling period)
SO ₂	Hot rolling	mg/Nm ³	50-200 ⁽¹⁾ ⁽²⁾
	Cold rolling, wire drawing, hot dip coating of sheets		20-100 ⁽¹⁾
⁽¹⁾ The BAT-AEL does not apply to plants using 100 % natural gas or 100 % electrical heating.			
⁽²⁾ The higher end of the BAT-AEL range may be higher and up to 300 mg/Nm ³ when using a high share of coke oven gas (> 50 % of energy input).			

The associated monitoring is given in BAT 7.

BAT 22. In order to prevent or reduce NO_x emissions to air from heating while limiting CO emissions and the emissions of NH₃ from the use of SNCR and/or SCR, BAT is to use either electricity generated from fossil-free energy sources or an appropriate combination of the techniques given below.

Technique	Description	Applicability	
<i>Reduction of generation of emissions</i>			
a.	Use of a fuel or a combination of fuels with low NO _x formation potential	Fuels with a low NO _x formation potential, e.g. natural gas, liquefied petroleum gas, blast furnace gas and basic oxygen furnace gas.	Generally applicable.
b.	Furnace automation and control	See Section 9.11.2	Generally applicable.
c.	Combustion optimisation	See Section 9.11.2 Generally used in combination with other techniques.	Generally applicable.
d.	Low-NO _x burners	See Section 9.11.2	Applicability may be restricted at existing plants by design and/or operational constraints.

e.	Flue-gas recirculation	Recirculation (external) of part of the flue-gas to the combustion chamber to replace part of the fresh combustion air, with the dual effect of lowering the temperature and limiting the O ₂ content for nitrogen oxidation, thus limiting the NO _x generation. It implies the supply of flue-gas from the furnace into the flame to reduce the oxygen content and therefore the temperature of the flame.	Applicability to existing plants may be restricted by a lack of space.
f.	Limiting the temperature of air preheating	Limiting the air preheating temperature leads to a decrease of the concentration of NO _x emissions. A balance has to be achieved between maximising heat recovery from the flue-gas and minimising NO _x emissions.	May not be applicable in the case of furnaces equipped with radiant tube burners.
g.	Flameless combustion	See Section 9.11.2	Applicability to existing plants may be limited by furnace design (i.e. furnace volume, space for burners, distance between burners) and the need for a change of the refractory lining. Applicability may be limited for processes where close control of the temperature or temperature profile is required (e.g. recrystallisation). Not applicable to furnaces operating at a temperature lower than the auto-ignition temperature required for flameless combustion, or to furnaces equipped with radiant tube burners.
h.	Oxy-fuel combustion	See Section 9.11.2	Applicability may be restricted for furnaces processing high-alloy steel. Applicability to existing plants may be restricted by furnace design and the need for a minimum waste gas flow. Not applicable to furnaces equipped with radiant tube burners.
Waste gas treatment			
i.	Selective catalytic reduction (SCR)	See Section 9.11.2	Applicability to existing plants may be restricted by a lack of space. Applicability may be restricted in batch annealing due to the varying temperatures during the annealing cycle.
j.	Selective non-catalytic reduction (SNCR)	See Section 9.11.2	Applicability to existing plants may be restricted by the optimum temperature window and the residence time needed for the reaction. Applicability may be restricted in batch annealing due to the varying temperatures during the annealing cycle.

k.	Optimisation of the SNCR/SCR design and operation	See Section 9.11.2	Only applicable where SNCR/SCR is used for the reduction of NO _x emissions.
----	---	--------------------	--

Table 9.9: BAT-associated emission levels (BAT-AELs) for channelled NO_x emissions to air and indicative emission levels for channelled CO emissions to air from feedstock heating in hot rolling

Parameter	Type of fuel	Specific process	Unit	BAT-AEL (Daily average or average over the sampling period)	Indicative emission level Daily average or average over the sampling period)
NO _x	100 % natural gas	Reheating	mg/Nm ³	New plants: 80-200 Existing plants: 100-350	No indicative level
		Intermediate heating	mg/Nm ³	100-250	
		Post-heating	mg/Nm ³	100-200	
	Other fuels	Reheating, intermediate heating, post-heating	mg/Nm ³	100-350 ⁽¹⁾	
CO	100 % natural gas	Reheating	mg/Nm ³	No BAT-AEL	10-50
		Intermediate heating	mg/Nm ³		10-100
		Post-heating	mg/Nm ³		10-100
	Other fuels	Reheating, intermediate heating, post-heating	mg/Nm ³		10-50

⁽¹⁾ The higher end of the BAT-AEL range may be higher and up to 550 mg/Nm³ when using a high share of coke oven gas or of CO-rich gas from ferrochromium production (> 50 % of energy input).

Table 9.10: BAT-associated emission levels (BAT-AELs) for channelled NO_x emissions to air and indicative emission levels for channelled CO emissions to air from feedstock heating in cold rolling

Parameter	Type of fuel	Unit	BAT-AEL (Daily average or average over the sampling period)	Indicative emission level Daily average or average over the sampling period)
NO _x	100 % natural gas	mg/Nm ³	100-250 ⁽¹⁾	No indicative level
	Other fuels	mg/Nm ³	100-300 ⁽²⁾	
CO	100 % natural gas	mg/Nm ³	No BAT-AEL	10-50
	Other fuels	mg/Nm ³	No BAT-AEL	10-100

⁽¹⁾ The higher end of the BAT-AEL range may be higher and up to 300 mg/Nm³ in continuous annealing.
⁽²⁾ The higher end of the BAT-AEL range may be higher and up to 550 mg/Nm³ when using a high share of coke oven gas or of CO-rich gas from ferrochromium production (> 50 % of energy input).

Table 9.11: BAT-associated emission level (BAT-AEL) for channelled NO_x emissions to air and indicative emission level for channelled CO emissions to air from feedstock heating in wire drawing

Parameter	Unit	BAT-AEL (Daily average or average over the sampling period)	Indicative emission level (Average over the sampling period)
NO _x	mg/Nm ³	100–250	No indicative level
CO	mg/Nm ³	No BAT-AEL	10–50

Table 9.12: BAT-associated emission level (BAT-AEL) for channelled NO_x emissions to air and indicative emission level for channelled CO emissions to air from feedstock heating in hot dip coating

Parameter	Unit	BAT-AEL (Daily average or average over the sampling period)	Indicative emission level (Daily average or average over the sampling period)
NO _x	mg/Nm ³	100–300 ⁽¹⁾	No indicative level
CO	mg/Nm ³	No BAT-AEL	10–100

(¹) The higher end of the BAT-AEL range may be higher and up to 550 mg/Nm³ when using a high share of coke oven gas or of CO-rich gas from ferrochromium production (> 50 % of energy input).

Table 9.13: BAT-associated emission level (BAT-AEL) for channelled NO_x emissions to air and indicative emission level for channelled CO emissions to air from heating the galvanising kettle in batch galvanising

Parameter	Unit	BAT-AEL (Daily average or average over the sampling period)	Indicative emission level (Daily average or average over the sampling period)
NO _x	mg/Nm ³	70–300	No indicative level
CO	mg/Nm ³	No BAT-AEL	10–100

The associated monitoring is given in BAT 7.

9.5.7.2 Emissions to air from degreasing

BAT 23. In order to reduce emissions to air of oil mist, acids and/or alkalis from degreasing in cold rolling and hot dip coating of sheets, BAT is to collect emissions by using technique (a) and to treat the waste gas by using technique (b) and/or technique (c) given below.

Technique		Description
<i>Collection of emissions</i>		
a.	Closed degreasing tanks combined with air extraction in the case of continuous degreasing	Degreasing is carried out in closed tanks and air is extracted.
<i>Waste gas treatment</i>		
b.	Wet scrubbing	See Section 9.11.2
c.	Demister	See Section 9.11.2

The associated monitoring is given in BAT 7.

9.5.7.3 Emissions to air from pickling

BAT 24. In order to reduce emissions to air of dust, acids (HCl, HF, H₂SO₄) and SO_x from pickling in hot rolling, cold rolling, hot dip coating and wire drawing, BAT is to use technique (a) or technique (b) in combination with technique (c) given below.

Technique		Description
<i>Collection of emissions</i>		
a.	Continuous pickling in closed tanks combined with fume extraction	Continuous pickling is carried out in closed tanks with limited entry and exit openings for the steel strip or wire. The fumes from the pickling tanks are extracted.
b.	Batch pickling in tanks equipped with lids or enclosing hoods combined with fume extraction	Batch pickling is carried out in tanks equipped with lids or enclosing hoods that can be opened to allow charging of the wire rod coils. The fumes from the pickling tanks are extracted.
<i>Waste gas treatment</i>		
c.	Wet scrubbing followed by a demister	See Section 9.11.2

Table 9.14: BAT-associated emission levels (BAT-AELs) for channelled emissions of HCl, HF and SO_x to air from pickling in hot rolling, cold rolling and hot dip coating

Parameter	Unit	BAT-AEL (Daily average or average over the sampling period)
HCl	mg/Nm ³	< 2-10 ⁽¹⁾
HF	mg/Nm ³	< 1 ⁽²⁾
SO _x	mg/Nm ³	< 1-6 ⁽³⁾

⁽¹⁾ This BAT-AEL only applies to pickling with hydrochloric acid.
⁽²⁾ This BAT-AEL only applies to pickling with acid mixtures containing hydrofluoric acid.
⁽³⁾ This BAT-AEL only applies to pickling with sulphuric acid.

Table 9.15: BAT-associated emission level (BAT-AEL) for channelled HCl and SO_x emissions to air from pickling with hydrochloric acid or sulphuric acid in wire drawing

Parameter	Unit	BAT-AEL (Daily average or average over the sampling period)
HCl	mg/Nm ³	< 2-10 ⁽¹⁾
SO _x	mg/Nm ³	< 1-6 ⁽²⁾

⁽¹⁾ This BAT-AEL only applies to pickling with hydrochloric acid.
⁽²⁾ This BAT-AEL only applies to pickling with sulphuric acid.

The associated monitoring is given in BAT 7.

BAT 25. In order to reduce NO_x emissions to air from pickling with nitric acid (alone or in combination with other acids) and the emissions of NH₃ from the use of SCR, in hot rolling and cold rolling, BAT is to use one or a combination of the techniques given below.

Technique		Description	Applicability
Reduction of generation of emissions			
a.	Nitric-acid-free pickling of high-alloy steel	Pickling of high-alloy steel is carried out by fully substituting nitric acid with a strong oxidising agent (e.g. hydrogen peroxide).	Only applicable to new plants and major plant upgrades.
b.	Addition of hydrogen peroxide or urea to the pickling acid	Hydrogen peroxide or urea is added directly to the pickling acid to reduce NO _x emissions.	Generally applicable.
Collection of emissions			
c.	Continuous pickling in closed tanks combined with fume extraction	Continuous pickling is carried out in closed tanks with limited entry and exit openings for the steel strip or wire. The fumes from the pickling bath are extracted.	Generally applicable.
d.	Batch pickling in tanks equipped with lids or enclosing hoods combined with fume extraction	Batch pickling is carried out in tanks equipped with lids or enclosing hoods that can be opened to allow charging of the wire rod coils. The fumes from the pickling tanks are extracted.	Generally applicable.
Waste gas treatment			
e.	Wet scrubbing with addition of an oxidising agent (e.g. hydrogen peroxide)	See Section 9.11.2. An oxidising agent (e.g. hydrogen peroxide) is added to the scrubbing solution to reduce NO _x emissions. When using hydrogen peroxide, the nitric acid formed can be recycled to the pickling tanks.	Generally applicable.
f.	Selective catalytic reduction (SCR)	See Section 9.11.2.	Applicability to existing plants may be restricted by a lack of space.
g.	Optimisation of the SCR design and operation	See Section 9.11.2.	Only applicable where SCR is used for the reduction of NO _x emissions.

Table 9.16: BAT-associated emission level (BAT-AEL) for channelled NO_x emissions to air from pickling with nitric acid (alone or in combination with other acids) in hot rolling and cold rolling

Parameter	Unit	BAT-AEL (Daily average or average over the sampling period)
NO _x	mg/Nm ³	10–200

The associated monitoring is given in BAT 7.

9.5.7.4 Emissions to air from hot dipping

BAT 26. In order to reduce emissions to air of dust and zinc from hot dipping after fluxing in hot dip coating of wires and in batch galvanising, BAT is to reduce the generation of emissions by using technique (b) or techniques (a) and (b), to collect the emissions by using technique (c) or technique (d), and to treat the waste gases by using technique (e) given below.

Technique	Description	Applicability
<i>Reduction of generation of emissions</i>		
a.	Low-fume flux Ammonium chloride in fluxing agents is partly substituted with other alkali chlorides (e.g. potassium chloride) to reduce dust formation.	Applicability may be restricted due to product specifications.
b.	Minimisation of carry-over of the fluxing solution This includes techniques such as: – allowing enough time for the fluxing solution to drip off (see BAT 15 (c)); – drying before dipping.	Generally applicable.
<i>Collection of emissions</i>		
c.	Air extraction as close as possible to the source Air from the kettle is extracted, for example using lateral hood or lip extraction.	Generally applicable.
d.	Enclosed kettle combined with air extraction Hot dipping is carried out in an enclosed kettle and air is extracted.	Applicability to existing plants may be limited where enclosure interferes with an existing transport system for workpieces in batch galvanising.
<i>Waste gas treatment</i>		
e.	Fabric filter See Section 9.11.2.	Generally applicable.

Table 9.17: BAT-associated emission level (BAT-AEL) for channelled dust emissions to air from hot dipping after fluxing in hot dip coating of wires and in batch galvanising

Parameter	Unit	BAT-AEL (Daily average or average over the sampling period)
Dust	mg/Nm ³	< 2–5

The associated monitoring is given in BAT 7.

9.5.7.5 Emissions to air from oiling

BAT 27. In order to prevent oil mist emissions to air and to reduce the consumption of oil from oiling of the feedstock surface, BAT is to use one of the techniques given below.

Technique		Description
a.	Electrostatic oiling	Oil is sprayed on the metal surface through an electrostatic field, which ensures homogeneous oil application and optimises the quantity of oil applied. The oiling machine is enclosed and oil that does not deposit on the metal surface is recovered and reused within the machine.
b.	Contact lubrication	Roller lubricators, e.g. felt rolls or squeeze rolls, are used in direct contact with the metal surface.
c.	Oiling without compressed air	Oil is applied with nozzles close to the metal surface using high-frequency valves.

9.5.7.6 Emissions to air from post-treatment

BAT 28. In order to reduce emissions to air from chemical baths or tanks in post-treatment (i.e. phosphating and passivation), BAT is to collect the emissions by using technique (a) or technique (b), and in that case to treat the waste gas by using technique (c) and/or technique (d) given below.

Technique		Description	Applicability
<i>Collection of emissions</i>			
a.	Air extraction as close as possible to the source	Emissions from the chemical storage tanks and chemical baths are captured, e.g. by using one or a combination of the following techniques: <ul style="list-style-type: none"> - lateral hood or lip extraction; - tanks equipped with moveable lids; - enclosing hoods; - placing the baths in enclosed areas. The captured emissions are then extracted.	Only applicable when the treatment is carried out by spraying or when volatile substances are used.
b.	Closed tanks combined with air extraction in the case of continuous post-treatment	Phosphating and passivation are carried out in closed tanks and the air is extracted from the tanks.	Only applicable when the treatment is carried out by spraying or when volatile substances are used.
<i>Waste gas treatment</i>			
c.	Wet scrubbing	See Section 9.11.2.	Generally applicable.
d.	Demister	See Section 9.11.2.	Generally applicable.

9.5.7.7 Emissions to air from acid recovery

BAT 29. In order to reduce emissions to air from the recovery of spent acid of dust, acids (HCl, HF), SO₂ and NO_x (while limiting CO emissions) and the emissions of NH₃ from the use of SCR, BAT is to use a combination of the techniques given below.

Technique		Description	Applicability
a.	Use of a fuel or a combination of fuels with low sulphur content and/or low NO _x formation potential	See BAT 21 and BAT 22 (a).	Generally applicable.
b.	Combustion optimisation	See Section 9.11.2. Generally used in combination with other techniques.	Generally applicable.
c.	Low-NO _x burners	See Section 9.11.2.	Applicability may be restricted at existing plants by design and/or operational constraints.
d.	Wet scrubbing followed by a demister	See Section 9.11.2. In the case of mixed acid recovery, an alkali is added to the scrubbing solution to remove traces of HF and/or an oxidising agent (e.g. hydrogen peroxide) is added to the scrubbing solution to reduce NO _x emissions. When using hydrogen peroxide, the nitric acid formed can be recycled to the pickling tanks.	Generally applicable.
e.	Selective catalytic reduction (SCR)	See Section 9.11.2.	Applicability to existing plants may be restricted by a lack of space.
f.	Optimisation of the SCR design and operation	See Section 9.11.2.	Only applicable where SCR is used for the reduction of NO _x emissions.

Table 9.18: BAT-associated emission levels (BAT-AELs) for channelled emissions of dust, HCl, SO₂ and NO_x to air from the recovery of spent hydrochloric acid by spray roasting or by using fluidised bed reactors

Parameter	Unit	BAT-AEL
		(Daily average or average over the sampling period)
Dust	mg/Nm ³	< 2–15
HCl	mg/Nm ³	< 2–15
SO ₂	mg/Nm ³	< 10
NO _x	mg/Nm ³	50–180

Table 9.19: BAT-associated emission levels (BAT-AELs) for channelled emissions of dust, HF and NO_x to air from the recovery of mixed acid by spray roasting or evaporation

Parameter	Unit	BAT-AEL
		(Daily average or average over the sampling period)
HF	mg/Nm ³	< 1
NO _x	mg/Nm ³	50–100 ⁽¹⁾
Dust	mg/Nm ³	< 2–10

⁽¹⁾ The higher end of the BAT-AEL range may be higher and up to 200 mg/Nm³ in the case of recovery of mixed acid by spray roasting.

The associated monitoring is given in BAT 7.

9.5.8 Emissions to water

BAT 30. In order to reduce the load of organic pollutants in water contaminated with oil or grease (e.g. from oil spillages or from the cleaning of rolling and tempering emulsions, degreasing solutions and wire-drawing lubricants) that is sent to further treatment (see BAT 31), BAT is to separate the organic and the aqueous phase.

Description

The organic phase is separated from the aqueous phase, e.g. by skimming or by emulsion splitting with suitable agents, evaporation or membrane filtration. The organic phase may be used for energy or material recovery (e.g. see BAT 34 (f)).

BAT 31. In order to reduce emissions to water, BAT is to treat waste water using a combination of the techniques given below.

Technique ⁽¹⁾		Typical pollutants targeted
<i>Preliminary, primary and general treatment, e.g.</i>		
a.	Equalisation	All pollutants
b.	Neutralisation	Acids, alkalis
c.	Physical separation, e.g. screens, sieves, grit separators, grease separators, hydrocyclones, oil-water separation or primary settlement tanks	Gross solids, suspended solids, oil/grease
<i>Physico-chemical treatment, e.g.</i>		
d.	Adsorption	Adsorbable dissolved non-biodegradable or inhibitory pollutants, e.g. hydrocarbons, mercury
e.	Chemical precipitation	Precipitable dissolved non-biodegradable or inhibitory pollutants, e.g. metals, phosphorus, fluoride
f.	Chemical reduction	Reducible dissolved non-biodegradable or inhibitory pollutants, e.g. hexavalent chromium
g.	Nanofiltration/reverse osmosis	Soluble non-biodegradable or inhibitory pollutants, e.g. salts, metals
<i>Biological treatment, e.g.</i>		
h.	Aerobic treatment	Biodegradable organic compounds
<i>Solids removal, e.g.</i>		
i.	Coagulation and flocculation	Suspended solids and particulate-bound metals
j.	Sedimentation	
k.	Filtration (e.g. sand filtration, microfiltration, ultrafiltration)	
l.	Flotation	
⁽¹⁾ The descriptions of the techniques are given in Section 9.11.3.		

Table 9.20: BAT-associated emission levels (BAT-AELs) for direct discharges to a receiving water body

Substance/Parameter	Unit	BAT-AEL (¹)	Process(es) to which the BAT-AEL applies	
Total suspended solids (TSS)	mg/l	5-30	All processes	
Total organic carbon (TOC) (²)	mg/l	10-30	All processes	
Chemical oxygen demand (COD) (²)	mg/l	30-90	All processes	
Hydrocarbon oil index (HOI)	mg/l	0.5-4	All processes	
Metals	Cd	µg/l	1-5	
	Cr	mg/l	0.01-0.1 (⁴)	
	Cr(VI)	µg/l	10-50	Pickling of high-alloy steel or passivation with hexavalent chromium compounds
	Fe	mg/l	1-5	All processes
	Hg	µg/l	0.1-0.5	All processes (³)
	Ni	mg/l	0.01-0.2 (⁵)	All processes (³)
	Pb	µg/l	5-20 (⁶) (⁷)	All processes (³)
	Sn	mg/l	0.01-0.2	Hot dip coating using tin
Zn	mg/l	0.05-1	All processes (³)	
Total phosphorus (Total P)	mg/l	0.2-1	Phosphating	
Fluoride (F ⁻)	mg/l	1-15	Pickling with acid mixtures containing hydrofluoric acid	

(¹) The averaging periods are defined in the General considerations.

(²) Either the BAT-AEL for COD or the BAT-AEL for TOC applies. TOC monitoring is the preferred option because it does not rely on the use of very toxic compounds.

(³) The BAT-AEL only applies when the substance(s)/parameter(s) concerned is identified as relevant in the waste water stream based on the inventory mentioned in BAT 2.

(⁴) The higher end of the BAT-AEL range is 0.3 mg/l in the case of high-alloy steels.

(⁵) The higher end of the BAT-AEL range is 0.4 mg/l in the case of plants producing austenitic stainless steel.

(⁶) The higher end of the BAT-AEL range is 35 µg/l in the case of wire drawing plants using lead baths.

(⁷) The higher end of the BAT-AEL range may be higher and up to 50 µg/l in the case of plants processing leaded steel.

Table 9.21: BAT-associated emission levels (BAT-AELs) for indirect discharges to a receiving water body

Substance/Parameter	Unit	BAT-AEL (¹) (²)	Process(es) to which the BAT-AEL applies
Hydrocarbon oil index (HOI)	mg/l	0.5-4	All processes
Metals	Cd	µg/l	1-5
	Cr	mg/l	0.01-0.1 (⁴)
	Cr(VI)	µg/l	10-50
	Fe	mg/l	1-5
	Hg	µg/l	0.1-0.5
	Ni	mg/l	0.01-0.2 (⁵)
	Pb	µg/l	5-20 (⁶) (⁷)
	Sn	mg/l	0.01-0.2
Zn	mg/l	0.05-1	
Fluoride (F ⁻)	mg/l	1-15	Pickling with acid mixtures containing hydrofluoric acid

(¹) The averaging periods are defined in the general considerations.
(²) The BAT-AELs may not apply if the downstream waste water treatment plant is designed and equipped appropriately to abate the pollutants concerned, provided this does not lead to a higher level of pollution in the environment.
(³) The BAT-AEL only applies when the substance(s)/parameter(s) concerned is identified as relevant in the waste water stream based on the inventory mentioned in BAT 2.
(⁴) The higher end of the BAT-AEL range is 0.3 mg/l in the case of high-alloy steels.
(⁵) The higher end of the BAT-AEL range is 0.4 mg/l in the case of plants producing austenitic stainless steel.
(⁶) The higher end of the BAT-AEL range is 35 µg/l in the case of wire drawing plants using lead baths.
(⁷) The higher end of the BAT-AEL range may be higher and up to 50 µg/l in the case of plants processing leaded steel.

The associated monitoring is given in BAT 8.

9.5.9 Noise and vibrations

BAT 32. In order to prevent or, where that is not practicable, to reduce noise and vibration emissions, BAT is to set up, implement and regularly review a noise and vibration management plan, as part of the EMS (see BAT 1), that includes all of the following elements:

- i. a protocol containing appropriate actions and timelines;
- ii. a protocol for conducting noise and vibration monitoring;
- iii. a protocol for response to identified noise and vibration events, e.g. complaints;
- iv. a noise and vibration reduction programme designed to identify the source(s), to measure/estimate noise and vibration exposure, to characterise the contributions of the sources and to implement prevention and/or reduction measures.

Applicability

The applicability is restricted to cases where a noise or vibration nuisance at sensitive receptors is expected and/or has been substantiated.

BAT 33. In order to prevent or, where that is not practicable, to reduce noise and vibration emissions, BAT is to use one or a combination of the techniques given below.

Technique	Description	Applicability
a. Appropriate location of equipment and buildings	Noise levels can be reduced by increasing the distance between the emitter and the receiver, by using buildings as noise screens and by relocating the exits or entrances of the buildings.	For existing plants, the relocation of equipment and the exits or entrances of the buildings may not be applicable due to a lack of space and/or excessive costs.
b. Operational measures	These include techniques such as: <ul style="list-style-type: none"> – inspection and maintenance of equipment; – closing of doors and windows of enclosed areas, if possible; – equipment operation by experienced staff; – avoidance of noisy activities at night, if possible; – provisions for noise control, e.g. during production and maintenance activities, transport and handling of feedstock and materials. 	Generally applicable.
c. Low-noise equipment	This includes techniques such as direct drive motors, low-noise compressors, pumps and fans.	
d. Noise and vibration control equipment	This includes techniques such as: <ul style="list-style-type: none"> – noise reducers; – acoustic and vibrational insulation of equipment; – enclosure of noisy equipment (e.g. scarfing and grinding machines, wire drawing machines, air jets); – building materials with high sound insulation properties (e.g. for walls, roofs, windows, doors). 	Applicability to existing plants may be restricted by a lack of space.
e. Noise abatement	Inserting obstacles between emitters and receivers (e.g. protection walls, embankments and buildings).	Only applicable to existing plants, as the design of new plants should make this technique unnecessary. For existing plants, the insertion of obstacles may not be applicable due to a lack of space.

9.5.10 Residues

BAT 34. In order to reduce the quantity of waste sent for disposal, BAT is to avoid the disposal of metals, metal oxides and oily sludge and hydroxide sludge by using technique (a) and an appropriate combination of techniques (b) to (h) given below.

Technique		Description	Applicability
a.	Residues management plan	A residues management plan is part of the EMS (see BAT 1) and is a set of measures aiming to 1) minimise the generation of residues, 2) optimise the reuse, recycling and/or recovery of residues, and 3) ensure the proper disposal of waste. The residues management plan may be integrated in the overall residues management plan of a larger installation (e.g. for iron and steel production).	The level of detail and the degree of formalisation of the residues management plan will generally be related to the nature, scale and complexity of the installation.
b.	Pretreatment of oily mill scale for further use	This includes techniques such as: - briquetting or pelletising; - reducing the oil content of oily mill scale, e.g. by thermal treatment, washing, flotation.	Generally applicable.
c.	Use of mill scale	Mill scale is collected and used on site or off site, e.g. in iron and steel production or in cement production.	Generally applicable.
d.	Use of metallic scrap	Metallic scrap from mechanical processes (e.g. from trimming and finishing) is used in iron and steel production. This may take place on site or off site.	Generally applicable.
e.	Recycling of metal and metal oxides from dry waste gas cleaning	The coarse fraction of metal and metal oxides originating from dry cleaning (e.g. fabric filters) of waste gases from mechanical processes (e.g. scarfing or grinding) is selectively isolated using mechanical techniques (e.g. sieves) or magnetic techniques and recycled, e.g. to iron and steel production. This may take place on site or off site.	Generally applicable.
f.	Use of oily sludge	Residual oily sludge, e.g. from degreasing, is dewatered to recover the oil contained therein for material or energy recovery. If the water content is low, the sludge can be directly used. This may take place on site or off site.	Generally applicable.
g.	Thermal treatment of hydroxide sludge from the recovery of mixed acid	Sludge generated from the recovery of mixed acid is thermally treated in order to produce a material rich in calcium fluoride that can be used in argon oxygen decarburisation converters.	Applicability may be restricted by a lack of space.
h.	Recovery and reuse of shot blast media	Where mechanical descaling is carried out by shot blasting, the shot blast media are separated from the scale and reused.	Generally applicable.

BAT 35. In order to reduce the quantity of waste sent for disposal from hot dipping, BAT is to avoid the disposal of zinc-containing residues by using all of the techniques given below.

Technique		Description	Applicability
a.	Recycling of fabric filter dust	Dust from fabric filters containing ammonium chloride and zinc chloride is collected and reused, e.g. to produce fluxing agents. This may take place on site or off site.	Only applicable in hot dipping after fluxing. Applicability may be restricted depending on the availability of a market.
b.	Recycling of zinc ash and top dross	Metallic zinc is recovered from zinc ash and top dross by melting in recovery furnaces. The remaining zinc-containing residue is used, e.g. for zinc oxide production. This may take place on site or off site.	Generally applicable.
c.	Recycling of bottom dross	Bottom dross is used, e.g. in the non-ferrous metals industries to produce zinc. This may take place on site or off site.	Generally applicable.

BAT 36. In order to improve the recyclability and recovery potential of the zinc-containing residues from hot dipping (i.e. zinc ash, top dross, bottom dross, zinc splashes, and fabric filter dust) as well as to prevent or reduce the environmental risk associated with their storage, BAT is to store them separately from each other and from other residues on:

- impermeable surfaces, in enclosed areas and in closed containers/bags, for fabric filter dust;
- impermeable surfaces and in covered areas protected from surface run-off water, for all the other residue types above.

BAT 37. In order to increase material efficiency and to reduce the quantity of waste sent for disposal from texturing of working rolls, BAT is to use all of the techniques given below.

Technique		Description
a.	Cleaning and reuse of grinding emulsion	Grinding emulsions are treated using lamellar or magnetic separators or using a sedimentation/clarification process in order to remove the grinding sludge and reuse the grinding emulsion.
b.	Treatment of grinding sludge	Treatment of grinding sludge by magnetic separation for recovery of metal particles and recycling of metals, e.g. to iron and steel production.
c.	Recycling of worn working rolls	Worn working rolls which are unsuitable for texturing are recycled to iron and steel production or returned to the manufacturer for refabrication.

Further sector-specific techniques to reduce the quantity of waste sent for disposal are given in Section 9.8.4 of these BAT conclusions.

9.6 BAT conclusions for hot rolling

The BAT conclusions in this section apply in addition to the general BAT conclusions given in Section 9.5.

9.6.1 Energy efficiency

BAT 38. In order to increase energy efficiency in feedstock heating, BAT is to use a combination of the techniques given in BAT 11 together with an appropriate combination of the techniques given below.

Technique		Description	Applicability
a.	Near-net-shape casting for thin slabs and beam blanks followed by rolling	See Section 9.11.1.	Only applicable to plants adjacent to continuous casting and within the limitations of the plant layout and product specifications.
b.	Hot/direct charging	Continuous-cast steel products are directly charged hot into the reheating furnaces.	Only applicable to plants adjacent to continuous casting and within the limitations of the plant layout and product specifications.
c.	Heat recovery from skids cooling	Steam produced when cooling the skids supporting the feedstock in the reheating furnaces is extracted and used in other processes of the plant.	Applicability to existing plants may be restricted by a lack of space and/or of a suitable steam demand.
d.	Heat conservation during transfer of feedstock	Insulated covers are used between the continuous caster and the reheating furnace, and between the roughing mill and the finishing mill.	Generally applicable within the limitations of the plant layout.
e.	Coil boxes	See Section 9.11.1.	Generally applicable.
f.	Coil recovery furnaces	Coil recovery furnaces are used as an addition to coil boxes to restore the rolling temperature of coils and return them to a normal rolling sequence in the event of rolling mill interruptions.	Generally applicable.
g.	Sizing press	See BAT 39 (a). A sizing press is used to increase the energy efficiency in feedstock heating because it enables the hot charging rate to be increased.	Only applicable to new plants and major plant upgrades for hot strip mills.

BAT 39. In order to increase energy efficiency in rolling, BAT is to use a combination of the techniques given below.

Technique		Description	Applicability
a.	Sizing press	The use of a sizing press before the roughing mill enables the hot charging rate to be significantly increased and results in a more uniform width reduction both at the edges and centre of the product. The shape of the final slab is nearly rectangular, reducing significantly the number of rolling passes necessary to reach product specifications.	Only applicable to hot strip mills. Only applicable to new plants and major plant upgrades.
b.	Computer-aided rolling optimisation	The thickness reduction is controlled using a computer to minimise the number of rolling passes.	Generally applicable.
c.	Reduction of the rolling friction	See Section 9.11.1.	Only applicable to hot strip mills.
d.	Coil boxes	See Section 9.11.1.	Generally applicable.
e.	Three-roll stand	A three-roll stand increases the section reduction per pass, resulting in an overall reduction of the number of rolling passes required for producing wire rods and bars.	Generally applicable.
f.	Near-net-shape casting for thin slabs and beam blanks followed by rolling	See Section 9.11.1.	Only applicable to plants adjacent to continuous casting and within the limitations of the plant layout and product specifications.

Table 9.22: BAT-associated environmental performance levels (BAT-AEPLs) for specific energy consumption in rolling

Steel products at the end of the rolling process	Unit	BAT-AEPL (yearly average)
<i>Hot rolled coils (strips), heavy plates</i>	MJ/t	100-400
<i>Bars, rods</i>	MJ/t	100-500 ⁽¹⁾
<i>Beams, billets, rails, tubes</i>	MJ/t	100-300

⁽¹⁾ In the case of high-alloy steel (e.g. austenitic stainless steel), the higher end of the BAT-AEPL range is 1 000 MJ/t.

The associated monitoring is given in BAT 6.

9.6.2 Material efficiency

BAT 40. In order to increase material efficiency, and to reduce the quantity of waste sent for disposal from feedstock conditioning, BAT is to avoid or, where that is not practicable, to reduce the need for conditioning by applying one or a combination of the techniques given below.

Technique		Description	Applicability
a.	Computer-aided quality control	The quality of slabs is controlled by a computer which allows the adjustment of the casting conditions to minimise surface defects and enables manual scarfing of the damaged area(s) only rather than scarfing of the entire slab.	Only applicable to plants with continuous casting.
b.	Slab slitting	The slabs (often cast in multiple widths) are slit before hot rolling by means of slitting devices, slit rolling or torches either manually operated or mounted on a machine.	May not be applicable for slabs produced from ingots.
c.	Edging or trimming of wedge-type slabs	Wedge-type slabs are rolled under special settings where the wedge is eliminated by edging (e.g. using automatic width control or a sizing press) or by trimming.	May not be applicable for slabs produced from ingots. Only applicable to new plants and major plant upgrades.

BAT 41. In order to increase material efficiency in rolling for the production of flat products, BAT is to reduce the generation of metallic scrap by using both of the techniques given below.

Technique		Description
a.	Crop optimisation	The cropping of the feedstock after roughing is controlled by a shape measurement system (e.g. camera) in order to minimise the amount of metal cut off.
b.	Control of the feedstock shape during rolling	Any deformations of the feedstock during rolling are monitored and controlled in order to ensure that the rolled steel has as rectangular a shape as possible and to minimise the need for trimming.

9.6.3 Emissions to air

BAT 42. In order to reduce emissions to air of dust, nickel and lead in mechanical processing (including slitting, descaling, grinding, roughing, rolling, finishing, levelling), scarfing and welding, BAT is to collect the emissions by using techniques (a) and (b) and in that case to treat the waste gas by using one or a combination of the techniques (c) to (e) given below.

Technique	Description	Applicability	
Collection of emissions			
a.	Enclosed scarfing and grinding combined with air extraction	Scarfing (other than manual scarfing) and grinding operations are carried out completely enclosed (e.g. under closed hoods) and air is extracted.	Generally applicable.
b.	Air extraction as close as possible to the emission source	Emissions from slitting, descaling, roughing, rolling, finishing, levelling and welding are collected, for example using hood or lip extraction. For roughing and rolling, in the case of low levels of dust generation, e.g. below 100 g/h, water sprays can be used instead (see BAT 43).	May not be applicable for welding in the case of low levels of dust generation, e.g. below 50 g/h.
Waste gas treatment			
c.	Electrostatic precipitator	See Section 9.11.2.	Generally applicable.
d.	Fabric filter	See Section 9.11.2.	May not be applicable in the case of waste gases with a high moisture content.
e.	Wet scrubbing	See Section 9.11.2.	Generally applicable.

Table 9.23: BAT-associated emission levels (BAT-AELs) for channelled emissions of dust, lead and nickel to air from mechanical processing (including slitting, descaling, grinding, roughing, rolling, finishing, levelling), scarfing (other than manual scarfing) and welding

Parameter	Unit	BAT-AEL (Daily average or average over the sampling period)
Dust	mg/Nm ³	< 2-5 ⁽¹⁾
Ni		0.01-0.1 ⁽²⁾
Pb		0.01-0.035 ⁽²⁾
⁽¹⁾ When a fabric filter is not applicable, the higher end of the BAT-AEL range may be higher and up to 7 mg/Nm ³ . ⁽²⁾ The BAT-AEL only applies when the substance concerned is identified as relevant in the waste gas stream based on the inventory given in BAT 2.		

The associated monitoring is given in BAT 7.

BAT 43. In order to reduce emissions to air of dust, nickel and lead in roughing and rolling in the case of low levels of dust generation (e.g. below 100 g/h (see BAT 42 (b))), BAT is to use water sprays.

Description

Water spraying injection systems are installed at the exit side of each roughing and rolling stand to abate dust generation. The humidification of dust particles facilitates agglomeration and dust settling. The water is collected at the bottom of the stand and treated (see BAT 31).

9.7 BAT conclusions for cold rolling

The BAT conclusions in this section apply in addition to the general BAT conclusions given in Section 9.5.

9.7.1 Energy efficiency

BAT 44. In order to increase energy efficiency in rolling, BAT is to use a combination of the techniques given below.

Technique		Description	Applicability
a.	Continuous rolling for low-alloy and alloy steel	Continuous rolling (e.g. using tandem mills) is employed instead of conventional discontinuous rolling (e.g. using reversing mills), allowing for stable feed and less frequent start-ups and shutdowns.	Only applicable to new plants and major plant upgrades. Applicability may be restricted due to product specifications.
b.	Reduction of the rolling friction	See Section 9.11.1.	Generally applicable.
c.	Computer-aided rolling optimisation	The thickness reduction is controlled using a computer to minimise the number of rolling passes.	Generally applicable.

Table 9.24: BAT-associated environmental performance levels (BAT-AEPLs) for specific energy consumption in rolling

Steel products at the end of the rolling process	Unit	BAT-AEPL (Yearly average)
Cold rolled coils	MJ/t	100–300 ⁽¹⁾
Packaging steel	MJ/t	250–400

⁽¹⁾ In the case of high-alloy steel (e.g. austenitic stainless steel), the higher end of the BAT-AEPL range may be higher and up to 1 600 MJ/t.

The associated monitoring is given in BAT 6.

9.7.2 Material efficiency

BAT 45. In order to increase material efficiency and to reduce the quantity of waste sent for disposal from rolling, BAT is to use all of the techniques given below.

Technique		Description	Applicability
a.	Monitoring and adjustment of the rolling emulsion quality	Important characteristics of the rolling emulsion (e.g. oil concentration, pH, emulsion droplet size, saponification index, acid concentration, concentration of iron fines, concentration of bacteria) are monitored regularly or continuously to detect anomalies in the emulsion quality and take corrective action, if needed.	Generally applicable.
b.	Prevention of contamination of the rolling emulsion	Contamination of the rolling emulsion is prevented by techniques such as: <ul style="list-style-type: none"> - regular control and preventive maintenance of the hydraulic system and the emulsion circulation system; - reducing bacterial growths in the rolling emulsion system by regular cleaning or operating at low temperatures. 	Generally applicable.
c.	Cleaning and reuse of the rolling emulsion	Particulate matter (e.g. dust, steel slivers and scale) contaminating the rolling emulsion is removed in a cleaning circuit (usually based on sedimentation combined with filtration and/or magnetic separation) in order to maintain the emulsion quality and the treated rolling emulsion is reused. The degree of reuse is limited by the content of impurities in the emulsion.	Applicability may be restricted due to product specifications.
d.	Optimal choice of rolling oil and emulsion system	Rolling oil and emulsion systems are carefully selected to provide the optimum performance for the given process and product. Relevant characteristics to be considered are, for example: <ul style="list-style-type: none"> - good lubrication; - potential for easy separation of contaminants; - stability of the emulsion and dispersion of the oil in the emulsion; - non-degradation of the oil over a long idling time. 	Generally applicable.
e.	Minimisation of oil/rolling emulsion consumption	The consumption of oil/rolling emulsion is minimised by using techniques such as: <ul style="list-style-type: none"> - limiting the oil concentration to the minimum required for lubrication; - limiting carry-over of emulsion from the previous stands (e.g. by separating the emulsion cells, shielding of the mill stands); - using air knives combined with edge suction to reduce the residual emulsion and oil on the strip. 	Generally applicable.

9.7.3 Emissions to air

BAT 46. In order to reduce emissions to air of dust, nickel and lead from decoiling, mechanical predescaling, levelling and welding, BAT is to collect the emissions by using technique (a) and in that case to treat the waste gas by using technique (b).

Technique		Description	Applicability
Collection of emissions			
a.	Air extraction as close as possible to the emission source	Emissions from decoiling, mechanical predescaling, levelling and welding are collected, for example using hood or lip extraction.	May not be applicable for welding in the case of low levels of dust generation, e.g. below 50 g/h.
Waste gas treatment			
b.	Fabric filter	See Section 9.11.2.	Generally applicable.

Table 9.25: BAT-associated emission levels (BAT-AELs) for channelled emissions of dust, nickel and lead to air from decoiling, mechanical predecasing, levelling and welding

Parameter	Unit	BAT-AEL (Daily average or average over the sampling period)
Dust	mg/Nm ³	< 2–5
Ni		0.01–0.1 ⁽¹⁾
Pb		≤ 0.003 ⁽¹⁾

⁽¹⁾ The BAT-AEL only applies when the substance concerned is identified as relevant in the waste gas stream based on the inventory given in BAT 2.

The associated monitoring is given in BAT 7.

BAT 47. In order to prevent or reduce oil mist emissions to air from tempering, BAT is to use one of the techniques given below.

Technique		Description	Applicability
a.	Dry tempering	No water or lubricants are used for tempering.	Not applicable to tinplate packaging products and other products with high elongation requirements.
b.	Low-volume lubrication in wet tempering	Low-volume lubrication systems are employed to supply precisely the amount of lubricants needed for reducing the friction between the working rolls and the feedstock.	Applicability may be restricted due to product specifications in the case of stainless steel.

BAT 48. In order to reduce oil mist emissions to air from rolling, wet tempering and finishing, BAT is to use technique (a) in combination with technique (b) or in combination with both techniques (b) and (c) given below.

Technique		Description
<i>Collection of emissions</i>		
a.	Air extraction as close as possible to the emission source	Emissions from rolling, wet tempering and finishing are collected, for example using hood or lip extraction.
<i>Waste gas treatment</i>		
b.	Demister	See Section 9.11.2.
c.	Oil mist separator	Separators containing baffle packing, impingement plates or mesh pads are used to separate the oil from the extracted air.

Table 9.26: BAT-associated emission level (BAT-AEL) for channelled TVOC emissions to air from rolling, wet tempering and finishing

Parameter	Unit	BAT-AEL (Daily average or average over the sampling period)
TVOC	mg/Nm ³	< 3–8

The associated monitoring is given in BAT 7.

9.8 BAT conclusions for wire drawing

The BAT conclusions in this section apply in addition to the general BAT conclusions given in Section 9.5.

9.8.1 Energy efficiency

BAT 49. In order to increase the energy and material efficiency of lead baths, BAT is to use either a floating protective layer on the surface of the lead baths or tank covers.

Description

Floating protective layers and tank covers minimise heat losses and lead oxidation.

9.8.2 Material efficiency

BAT 50. In order to increase material efficiency and to reduce the quantity of waste sent for disposal from wet drawing, BAT is to clean and reuse the wire drawing lubricant.

Description

A cleaning circuit, e.g. with filtration and/or centrifugation, is used to clean the wire drawing lubricant for reuse.

9.8.3 Emissions to air

BAT 51. In order to reduce emissions to air of dust and lead from lead baths, BAT is to use all of the techniques given below.

Technique		Description
<i>Reduction of generation of emissions</i>		
a.	Minimisation of carry-over of lead	Techniques include the use of anthracite gravel to scrape off lead and the coupling of the lead bath with in-line pickling.
b.	Floating protective layer or tank cover	See BAT 49. Floating protective layers and tank covers also reduce emissions to air.
<i>Collection of emissions</i>		
c.	Air extraction as close as possible to the emission source	Emissions from the lead bath are collected, for example using hood or lip extraction.
<i>Waste gas treatment</i>		
d.	Fabric filter	See Section 9.11.2.

Table 9.27: BAT-associated emission levels (BAT-AELs) for channelled emissions of dust and lead to air from lead baths

Parameter	Unit	BAT-AEL (Daily average or average over the sampling period)
Dust	mg/Nm ³	< 2–5
Pb	mg/Nm ³	≤ 0.5

The associated monitoring is given in BAT 7.

BAT 52. In order to reduce dust emissions to air from dry drawing, BAT is to collect the emissions by using technique (a) or (b), and to treat the waste gas by using technique (c) given below.

Technique		Description	Applicability
<i>Collection of emissions</i>			
a.	Enclosed drawing machine combined with air extraction	The entire drawing machine is enclosed in order to avoid dispersion of dust and air is extracted.	Applicability to existing plants may be restricted by the plant layout.
b.	Air extraction as close as possible to the emission source	Emissions from the drawing machine are collected, for example using hood or lip extraction.	Generally applicable.
<i>Waste gas treatment</i>			
c.	Fabric filter	See Section 9.11.2.	Generally applicable.

Table 9.28: BAT-associated emission level (BAT-AEL) for channelled dust emissions to air from dry drawing

Parameter	Unit	BAT-AEL (Daily average or average over the sampling period)
Dust	mg/Nm ³	< 2–5

The associated monitoring is given in BAT 7.

BAT 53. In order to reduce oil mist emissions to air from oil quench baths, BAT is to use both of the techniques given below.

Technique		Description
<i>Collection of emissions</i>		
a.	Air extraction as close as possible to the emission source	Emissions from oil quench baths are collected, for example using lateral hood or lip extraction.
<i>Waste gas treatment</i>		
b.	Demister	See Section 9.11.2.

The associated monitoring is given in BAT 7.

9.8.4 Residues

BAT 54. In order to reduce the quantity of waste sent for disposal, BAT is to avoid the disposal of lead-containing residues by recycling them, e.g. to the non-ferrous metals industries to produce lead.

BAT 55. In order to prevent or reduce the environmental risk associated with the storage of lead-containing residues from lead baths (e.g. protective layer materials and lead oxides), BAT is to store lead-containing residues separately from other residues, on impermeable surfaces and in enclosed areas or in closed containers.

9.9 BAT conclusions for hot dip coating of sheets and wires

The BAT conclusions in this section apply in addition to the general BAT conclusions given in Section 9.5.

9.9.1 Material efficiency

BAT 56. In order to increase material efficiency in continuous hot dipping of strips, BAT is to avoid excess coating with metals by using both of the techniques given below.

Technique		Description
a.	Air knives for coating thickness control	After leaving the molten zinc bath, air jets stretching over the width of the strip blow the surplus coating metal off the strip surface back into the galvanising kettle.
b.	Stabilisation of the strip	The efficiency of the excess coating removal by air knives is improved by limiting the oscillations of the strip, e.g. by increasing strip tension, using low-vibration pot bearings, using electromagnetic stabilisers.

BAT 57. In order to increase material efficiency in continuous hot dipping of wire, BAT is to avoid excess coating with metals by using one of the techniques given below.

Technique		Description
a.	Air or nitrogen wiping	After leaving the molten zinc bath, circular air or gas jets around the wire blow the surplus coating metal off the wire surface back into the galvanising kettle.
b.	Mechanical wiping	After leaving the molten zinc bath, the wire is passed through wiping equipment/material (e.g. pads, nozzles, rings, charcoal granulate) which takes the surplus coating metal off the wire surface back into the galvanising kettle.

9.10 BAT conclusions for batch galvanising

The BAT conclusions in this section apply in addition to the general BAT conclusions given in Section 9.5.

9.10.1 Residues

BAT 58. In order to prevent the generation of spent acids with high zinc and high iron concentrations or, where that is not practicable, to reduce their quantity sent for disposal, BAT is to carry out pickling separately from stripping.

Description

Pickling and stripping are carried out in separate tanks in order to prevent the generation of spent acids with high zinc and high iron concentrations or to reduce their quantity sent for disposal.

Applicability

Applicability to existing plants may be restricted by a lack of space in the event that additional tanks for stripping are needed.

BAT 59. In order to reduce the quantity of spent stripping solutions with high zinc concentrations sent for disposal, BAT is to recover the spent stripping solutions and/or the ZnCl₂ and NH₄Cl contained therein.

Description

Techniques to recover spent stripping solutions with high zinc concentrations on site or off site include the following:

- Zinc removal by ion exchange. The treated acid can be used in pickling, while the ZnCl₂- and NH₄Cl-containing solution resulting from the stripping of the ion-exchange resin can be used for fluxing.
- Zinc removal by solvent extraction. The treated acid can be used in pickling, while the zinc-containing concentrate resulting from stripping and evaporation can be used for other purposes.

9.10.2 Material efficiency

BAT 60. In order to increase material efficiency in hot dipping, BAT is to use both of the techniques given below.

Technique		Description
a.	Optimised dipping time	The dipping time is limited to the duration required to achieve the coating thickness specifications.
b.	Slow withdrawal of workpieces from the bath	By withdrawing the galvanised workpieces slowly from the galvanising kettle, the drain-off is improved and zinc splashes are reduced.

BAT 61. In order to increase material efficiency and to reduce the quantity of waste sent for disposal from blowing off excess zinc from galvanised tubes, BAT is to recover zinc-containing particles and to reuse them in the galvanising kettle or to send them for zinc recovery.

9.10.3 Emissions to air

BAT 62. In order to reduce emissions of HCl to air from pickling and stripping in batch galvanising, BAT is to control the operating parameters (i.e. temperature and acid concentration in the bath) and to use the techniques given below with the following order of priority:

- technique (a) in combination with technique (c);
- technique (b) in combination with technique (c);
- technique (d) in combination with technique (b);
- technique (d).

Technique (d) is BAT only for existing plants and provided that it ensures at least an equivalent level of environmental protection compared to using technique (c) in combination with techniques (a) or (b).

Technique		Description	Applicability
Collection of emissions			
a.	Enclosed pretreatment section with extraction	The entire pretreatment section (e.g. degreasing, pickling, fluxing) is encapsulated and the fumes are extracted from the enclosure.	Only applicable to new plants and major plant upgrades
b.	Extraction by lateral hood or lip extraction	Acid fumes from the pickling tanks are extracted using lateral hoods or lip extraction at the edge of the pickling tanks. This may also include emissions from degreasing tanks.	Applicability in existing plants may be restricted by a lack of space.
Waste gas treatment			
c.	Wet scrubbing followed by a demister	See Section 9.11.2.	Generally applicable
Reduction of generation of emissions			
d.	Restricted operating range for hydrochloric acid open pickling baths	<p>Hydrochloric acid baths are strictly operated within the temperature and HCl concentration range determined by the following conditions:</p> <p>a) $4\text{ }^{\circ}\text{C} < T < (80 - 4w)\text{ }^{\circ}\text{C}$; b) $2\text{ wt-}\% < w < (20 - T/4)\text{ wt-}\%$, where T is the pickling acid temperature expressed in $^{\circ}\text{C}$ and w the HCl concentration expressed in wt-%.</p> <p>The bath temperature is measured at least once every day. The HCl concentration in the bath is measured every time fresh acid is replenished and in any case at least once every week. To limit evaporation, movement of air across the bath surfaces (e.g. due to ventilation) is minimised.</p>	Generally applicable

Table 9.29: BAT-associated emission level (BAT-AEL) for channelled HCl emissions to air from pickling and stripping with hydrochloric acid in batch galvanising

Parameter	Unit	BAT-AEL
		(Daily average or average over the sampling period)
HCl	mg/Nm ³	< 2 – 6

The associated monitoring is given in BAT 7.

9.10.4 Waste water discharge

BAT 63. It is not BAT to discharge waste water from batch galvanising.

Description

Only liquid residues (e.g. spent pickling acid, spent degreasing solutions and spent fluxing solutions) are generated. These residues are collected. They are appropriately treated for recycling or recovery and/or sent for disposal (see BAT 18 and BAT 59).

9.11 Descriptions of techniques

9.11.1 Techniques to increase energy efficiency

Technique	Description
Coil boxes	Insulated boxes are installed between the roughing mill and the finishing mill to minimise temperature losses from feedstock during coiling/uncoiling processes and allow for lower rolling forces in hot strip mills.
Combustion optimisation	Measures taken to maximise the efficiency of energy conversion in the furnace while minimising emissions (in particular of CO). This is achieved by a combination of techniques including good design of the furnace, optimisation of the temperature (e.g. efficient mixing of the fuel and combustion air) and residence time in the combustion zone, and use of furnace automation and control.
Flameless combustion	Flameless combustion is achieved by injecting fuel and combustion air separately into the combustion chamber of the furnace at high velocity to suppress flame formation and reduce the formation of thermal NO _x while creating a more uniform heat distribution throughout the chamber. Flameless combustion can be used in combination with oxy-fuel combustion.
Furnace automation and control	The heating process is optimised by using a computer system controlling in real time key parameters such as furnace and feedstock temperature, the air to fuel ratio and the furnace pressure.
Near-net-shape casting for thin slabs and beam blanks followed by rolling	Thin slabs and beam blanks are produced by combining casting and rolling in one process step. The need to reheat the feedstock before rolling and the number of rolling passes are reduced.
Optimisation of the SNCR/SCR design and operation	Optimisation of the reagent to NO _x ratio over the cross-section of the furnace or duct, of the size of the reagent drops and of the temperature window in which the reagent is injected.
Oxy-fuel combustion	Combustion air is replaced fully or partially with pure oxygen. Oxy-fuel combustion can be used in combination with flameless combustion.
Preheating of combustion air	Reuse of part of the heat recovered from the combustion flue-gas to preheat the air used in combustion.
Process gas management system	A system that enables iron and steel process gases to be directed to the feedstock heating furnaces, depending on their availability.
Recuperative burner	Recuperative burners employ different types of recuperators (e.g. heat exchangers with radiation, convection, compact or radiant tube designs) to directly recover heat from the flue-gases, which are then used to preheat the combustion air.
Reduction of the rolling friction	Rolling oils are carefully selected. Pure oil and/or emulsion systems are used to reduce the friction between the working rolls and the feedstock and to ensure minimal oil consumption. In HR, this is usually carried out in the first stands of the finishing mill.
Regenerative burner	Regenerative burners consist of two burners which are operated alternately and which contain beds of refractory or ceramic materials. While one burner is in operation, the heat of the flue-gas is absorbed by the refractory or ceramic materials of the other burner and then used to preheat the combustion air.
Waste heat recovery boiler	Heat from hot flue-gases is used to generate steam using a waste heat recovery boiler. The generated steam is used in other processes of the plant, for supplying a steam network or for generating electricity in a power plant.

9.11.2 Techniques to reduce emissions to air

Technique	Description
Combustion optimisation	See Section 9.11.1.
Demister	Demisters are filter devices that remove entrained liquid droplets from a gas stream. They consist of a woven structure of metal or plastic wires, with a high specific surface area. Through their momentum, small droplets present in the gas stream impinge against the wires and coalesce into bigger drops.
Electrostatic precipitator	Electrostatic precipitators (ESPs) operate such that particles are charged and separated under the influence of an electrical field. Electrostatic precipitators are capable of operating under a wide range of conditions. Abatement efficiency may depend on the number of fields, residence time (size), and upstream particle removal devices. They generally include between two and five fields. Electrostatic precipitators can be of the dry or of the wet type depending on the technique used to collect the dust from the electrodes. Wet ESPs are typically used at the polishing stage to remove residual dust and droplets after wet scrubbing.
Fabric filter	Fabric filters, often referred to as bag filters, are constructed from porous woven or felted fabric through which gases are passed to remove particles. The use of a fabric filter requires the selection of a fabric suitable for the characteristics of the waste gas and the maximum operating temperature.
Flameless combustion	See Section 9.11.1.
Furnace automation and control	See Section 9.11.1.
Low-NO _x burner	The technique (including ultra-low-NO _x burners) is based on the principles of reducing peak flame temperatures. The air/fuel mixing reduces the availability of oxygen and reduces the peak flame temperature, thus retarding the conversion of fuel-bound nitrogen to NO _x and the formation of thermal NO _x , while maintaining high combustion efficiency.
Optimisation of the SNCR/SCR design and operation	See Section 9.11.1.
Oxy-fuel combustion	See Section 9.11.1.
Selective catalytic reduction (SCR)	The SCR technique is based on the reduction of NO _x to nitrogen in a catalytic bed by reaction with urea or ammonia at an optimum operating temperature of around 300-450 °C. Several layers of catalyst may be applied. A higher NO _x reduction is achieved with the use of several catalyst layers.
Selective non-catalytic reduction (SNCR)	SNCR is based on the reduction of NO _x to nitrogen by reaction with ammonia or urea at a high temperature. The operating temperature window is maintained between 800 °C and 1 000 °C for optimal reaction.
Wet scrubbing	The removal of gaseous or particulate pollutants from a gas stream via mass transfer to a liquid solvent, often water or an aqueous solution. It may involve a chemical reaction (e.g. in an acid or alkaline scrubber). In some cases, the compounds may be recovered from the solvent.

9.11.3 Techniques to reduce emissions to water

Technique	Description
Adsorption	The removal of soluble substances (solutes) from the waste water by transferring them to the surface of solid, highly porous particles (typically activated carbon).
Aerobic treatment	The biological oxidation of dissolved organic pollutants with oxygen using the metabolism of microorganisms. In the presence of dissolved oxygen, injected as air or pure oxygen, the organic components are mineralised into carbon dioxide and water or are transformed into other metabolites and biomass.
Chemical precipitation	The conversion of dissolved pollutants into an insoluble compound by adding chemical precipitants. The solid precipitates formed are subsequently separated by sedimentation, air flotation or filtration. If necessary, this may be followed by microfiltration or ultrafiltration. Multivalent metal ions (e.g. calcium, aluminium, iron) are used for phosphorus precipitation.
Chemical reduction	The conversion of pollutants by chemical reducing agents into similar but less harmful or hazardous compounds.
Coagulation and flocculation	Coagulation and flocculation are used to separate suspended solids from waste water and are often carried out in successive steps. Coagulation is carried out by adding coagulants with charges opposite to those of the suspended solids. Flocculation is carried out by adding polymers, so that collisions of microfloc particles cause them to bond to produce larger flocs.
Equalisation	Balancing of flows and pollutant loads at the inlet of the final waste water treatment by using central tanks. Equalisation may be decentralised or carried out using other management techniques.
Filtration	The separation of solids from waste water by passing them through a porous medium, e.g. sand filtration, microfiltration and ultrafiltration.
Flotation	The separation of solid or liquid particles from waste water by attaching them to fine gas bubbles, usually air. The buoyant particles accumulate at the water surface and are collected with skimmers.
Nanofiltration	A filtration process in which membranes with pore sizes of approximately 1 nm are used.
Neutralisation	The adjustment of the pH of waste water to a neutral level (approximately 7) by the addition of chemicals. Sodium hydroxide (NaOH) or calcium hydroxide (Ca(OH) ₂) is generally used to increase the pH, whereas sulphuric acid (H ₂ SO ₄), hydrochloric acid (HCl) or carbon dioxide (CO ₂) is generally used to decrease the pH. The precipitation of some substances may occur during neutralisation.
Physical separation	The separation of gross solids, suspended solids and/or metal particles from the waste water using for example screens, sieves, grit separators, grease separators, hydrocyclones, oil-water separation or primary settlement tanks.
Reverse osmosis	A membrane process in which a pressure difference applied between the compartments separated by the membrane causes water to flow from the more concentrated solution to the less concentrated one.
Sedimentation	The separation of suspended particles and suspended material by gravitational settling.

10 CONCLUDING REMARKS AND RECOMMENDATIONS FOR FUTURE WORK

Timing of the review process

The key milestones of the review process are summarised in Table 10.1 below.

Table 10.1: Key milestones of the FMP BREF review process

Key milestone	Date
Reactivation of the TWG	27 November 2015
Wishes / initial positions	29 April 2016
Kick-off meeting	15 to 18 November 2016
Launch of the data collection via questionnaires	10 November 2017
Information and data collection	16 March 2018
Draft 1 (D1) of the revised FMP BREF	29 March 2019
End of commenting period on Draft 1 (1 568 comments received)	7 June 2019
Physical Final TWG meeting	Originally scheduled for the period: 30 March 2020 – 3 April 2020. Cancelled because of COVID-19 pandemic.
Second written consultation on the revised version of the draft BAT conclusions	12 October 2020 – 6 November 2020
Final TWG meeting (conducted as a series of nine web-based sessions)	23 November 2020 – 8 February 2021

The physical Final TWG meeting that was originally scheduled to take place at the Joint Research Centre in Sevilla between the 30th March 2020 and the 3rd April 2020 had to be cancelled because of the COVID-19 pandemic.

The way forward to finalise the review of the FMP BREF was agreed on the 25th September 2020 with the TWG, following a written consultation with the TWG realised in May 2020 (immediately after the cancellation of the final FMP TWG physical meeting) and a web-based TWG meeting held on 16th September 2020.

The way forward consisted in the following:

- *Second written consultation on the revised version of the draft BAT conclusions:* On 9th October 2020, the EIPPCB sent to the TWG a revised version of the draft BAT conclusions based on the comments received by the end of March 2020. Between 12th October and 6th November 2020, TWG members were able to provide comments on each section of the revised draft BAT conclusions document.
- *2 web-based sessions on non-controversial issues:* Sections of the BAT conclusions that received a low number of comments and/or minor comments were dealt with in two dedicated web-based sessions in November 2020 (23rd and 26th November 2020).
- *7 web-based sessions on controversial issues:* Sections of the BAT conclusions that received a relatively high number of comments and/or major comments were dealt with in 7 dedicated web-based sessions between the 10th December 2020 and 8th February 2021.

It is noted that because of the nature of the web-based meetings and in order to preserve data confidentiality, it was not possible to present CBI data on energy, water and material consumption during the web-based final meeting sessions. However, the CBI data were presented to the TWG during the second data workshop that was held in Sevilla on the 3-4 December 2019.

During the BREF review process, a total of 10 plants were visited in Austria, Spain and Sweden.

In addition, two events were organised to improve the exchange of information:

- 1st data assessment workshop (January 2019);
- 2nd data assessment workshop (December 2019).

Sources of information and information gaps

The main sources of information for the review process were:

- scientific and technical literature;
- 342 filled-in questionnaires (of which 265 contained confidential business information) from operators of ferrous metal processing plants;
- additional information from the TWG members;
- 1 568 comments on Draft 1 of the revised BREF;
- 371 comments on the revised version of the draft BAT conclusions (November 2020);
- information gathered from site visits;
- outcomes of the workshops mentioned above.

In total, approximately 400 documents have been posted in BATIS, and most of them have been referenced in the revised FMP BREF.

Degree of consensus reached during the information exchange

At the final TWG meeting that took place as a series of web-based sessions during the period November 2020 to February 2021, a high degree of consensus was reached on most of the BAT conclusions. However, 12 split views were expressed, which fulfil the conditions set out in Section 4.6.2.3.2 of Commission Implementing Decision 2012/119/EU. They are summarised in Table 10.2 below.

Table 10.2: Split views expressed

BAT conclusion / table number	Split view	View expressed by	Alternative proposed level (if any)
BAT 11 / Table 9.1	Include an additional footnote associated with feedstock post-heating (heavy plates, bars and rods) specifying that: “The higher end of the BAT-AEPL range may be higher when the feedstock is heated more than once in the same or different furnaces (e.g. normalising followed by tempering.”	EUROFER, supported by CZ	NA
BAT 20 / Table 9.7	Delete footnote ⁽¹⁾ .	AT, DE, SE, supported by EEB	NA
BAT 21 / Table 9.8	Amend footnote ⁽²⁾ as follows: “The higher end of the BAT-AEL range may be higher and up to 300 mg/Nm ³ when using a high share of coke oven gas (> 50% of energy input) and when the environmental benefit of thoroughly desulphurising COG would not be justified.”	EEB	50-300 mg/Nm ³
BAT 22 Table 9.9	Include a new footnote for reheating (existing plants), intermediate heating and post-heating when using 100% natural gas as follows: “The higher end of the BAT-AEL range may be exceeded when high air preheating is applied. In this case, the higher end of the BAT-AEL range is 400 mg/Nm ³ .”	EUROFER, supported by CZ and PT	400 mg/Nm ³
BAT 22 / Table 9.9	Include a new footnote for reheating, intermediate heating and post-heating when using other fuels as follows: “The higher end of the BAT-AEL range is 500 mg/Nm ³ when high air preheating is applied and when the share of coke oven gas or of CO-rich gas from ferrochromium production is < 50% of energy input. If high air preheating is used in combination with a high share of coke oven gas or of CO-rich gas from ferrochromium production (> 50% of energy input), the higher end of the BAT-AEL range is 800 mg/Nm ³ ”.	EUROFER, supported by CZ and SK	500 mg/Nm ³ (with high air preheating and a share of coke oven gas or of CO-rich gas from ferrochromium production < 50% of energy input) 800 mg/Nm ³ (with high air preheating and a share of coke oven gas or of CO-rich gas from ferrochromium production > 50% of energy input)
BAT 22 / Table 9.9	Include a new footnote for reheating (new and existing plants) when using 100% NG, and for reheating, intermediate heating and post-heating when using other fuels as	EUROFER	450 mg/Nm ³

	follows: “The higher end of the BAT-AEL range may be exceeded when processing high-alloy steels, e.g. stainless steel. In this case, the higher end of the BAT-AEL range is 450 mg/Nm ³ .”		
BAT 22 / Table 9.9	Increase the higher end of the BAT-AEL range for NO _x emissions in feedstock post-heating when using 100% natural gas to 250 mg/Nm ³ .	EUROFER	250 mg/Nm ³
BAT 22 / Table 9.10	Amend footnote ⁽¹⁾ as follows: “The higher end of the BAT-AEL range may be exceeded when high air preheating is applied. In this case, the higher end of the BAT-AEL range is 400 mg/Nm ³ .”	EUROFER, supported by SK	400 mg/Nm ³
BAT 22 / Table 9.12	Amend footnote ⁽¹⁾ as follows: “When high air preheating is applied, the higher end of the BAT-AEL range is 500 mg/Nm ³ when using 100% NG. When high air preheating is applied, the higher end of the BAT-AEL range is 800 mg/Nm ³ when a high share of coke oven gas or of CO-rich gas from ferrochromium production (> 50% of energy input) is used.”	EUROFER supported by SK	500 mg/Nm ³ (with high air preheating and 100% NG) 800 mg/Nm ³ (with high air preheating and a share of coke oven gas or of CO-rich gas from ferrochromium production > 50% of energy input)
BAT 34 (f)	Amend the description of technique (f) as follows: “Residual oily sludge, e.g. from degreasing, is dewatered to recover exclusively the oil contained therein for further use, preferably for other uses than fuel (e.g. reuse of works oil). If the water content is low and its properties are free of metal or halogen contaminants, the recovered oil fraction can be used as fuel.”	EEB	NA
BAT 62	Delete in the BAT statement the reference to ‘with the following order of priority’. Delete in the BAT statement the last sentence ‘Technique (d) is BAT only for existing plants and provided that it ensures at least an equivalent level of environmental protection compared to using technique (c) in combination with techniques (a) or (b).’	EGGA, ES ² supported by IT and PT	NA
BAT 62 / Table 9.29	Increase the higher end of the BAT-AEL for channelled HCl emissions to air from pickling and stripping with hydrochloric acid in batch galvanising.	EGGA	< 2-10 mg/Nm ³

² ES proposed in addition to use the occupational exposure limit values for HCl established according to the Commission Directive 2000/39/EC of 8 June 2000 for demonstrating that an equivalent level of environmental protection can be achieved with technique (d).

Consultation of the Forum and subsequent formal adoption procedure of the BAT Conclusions

In accordance with Article 13(3) of the Directive, the Forum gave its opinion on the draft Best Available Techniques (BAT) reference document for the Ferrous Metals Processing Industry in its meeting of 17 December 2021.

1. The Forum welcomed the draft Best Available Techniques (BAT) reference document for Ferrous Metals Processing Industry as presented by the Commission.
2. The Forum acknowledged the discussions held at its meeting of 17 December 2021 and agreed that the changes to the draft Best Available Techniques (BAT) reference document for Ferrous metals processing industry, as proposed in Annex A of the publicly available Forum opinion, should be included in the final document.
3. The Forum confirmed that the comments included in Annex B of the publicly available Forum opinion were representing the views of certain members of the Forum. For these comments, no consensus existed within the Forum and shall not be included in the final document.

Subsequently, the Commission took the opinion of the IED Article 13 Forum into account when preparing the draft Commission Implementing Decision establishing best available techniques (BAT) conclusions for the Ferrous metals processing industry. The IED Article 75 Committee, through a written procedure lasting until 17 June 2022, gave a positive opinion on this draft Commission Implementing Decision.

Subsequently, the Commission Implementing Decision (EU) establishing best available techniques (BAT) conclusions for the Ferrous metals processing industry was adopted on 11 October 2022 and published in the Official Journal of the European Union (OJ L 284, 4.11.2022, p. 69–133).

Recommendations for future work

The information exchange revealed a number of issues that should be addressed during the next review of the FMP BREF. The recommendations for the next review include the following:

- General recommendation:
 - To collect more information in the next BREF review on some of the BAT candidate techniques under the headings ‘Environmental performance and operational data’ and ‘Economics’ for which limited or no information was supplied by the TWG during this BREF review.
- Related to emissions to air:
 - To collect technical information on the specific cases (processes) where the oxygen in the waste gas of combustion processes is increased to a level very close to 21 vol-% as a result of additional air intake for safety reasons. In all cases, the oxygen content at which the emission concentrations are measured shall be systematically collected.
 - To collect further information on the use of electricity generated from fossil-free energy sources in heating processes (e.g. cross-media effects, example plants).
 - To collect further information on the techniques applied for limiting the entrainment of dust in reheating furnaces.
 - To collect more information on air preheating temperature for continuous and batch annealing.
 - To collect more information on NO_x emission data for the batch galvanising sector and especially for plants equipped with canopy heaters (e.g. high-temperature galvanising).
 - To collect more data on HF emissions from pickling of stainless steel using acid mixtures containing both H₂SO₄ and HF with injection of H₂O₂.

- To collect further information on SO_x emissions from pickling of wire rods in wire drawing.
- To collect further information on zinc emissions from hot dip coating of wires and batch galvanising.
- To collect further information on the monitoring of volatile substances and metals (e.g. chromium, nickel) from post-treatment processes.
- To collect more information on:
 - NO_x and dust emissions from the recovery of mixed acid by spray roasting and evaporation;
 - NH₃ emissions to air from the recovery of mixed acid by spray roasting, when SCR is used for NO_x abatement.
- To collect additional information on the emission concentrations achieved when applying only a restricted operating range for hydrochloric acid open pickling baths, demonstrating that an equivalent level of environmental protection is ensured in comparison to using extraction (either from the enclosure section or from the lateral hood or lip extraction) in combination with wet scrubbing followed by a demister.
- To collect more information on:
 - dust generation levels from roughing, rolling and welding processes as well as on applied abatement techniques;
 - dust emissions from shot blasting operations in the case of stainless steel.
- Related to specific energy consumption:
 - To collect more information on post-heating of heavy plates, bars and rods in the case of repetitive heat treatment steps (i.e. cases where the feedstock is heated more than once in the same or different furnaces).
 - To collect more information on the specific energy consumption levels in the case of feedstock processed using multiple annealing cycles.
 - To collect more information on (i) the annealing temperatures employed in cold rolling and hot dip coating, (ii) the technical reasons for operating at high annealing temperature (> 800 °C) and (iii) the associated energy consumption of annealing furnaces.
 - To collect more information on specific energy consumption for:
 - BG centrifuge plants;
 - high-temperature BG plants (galvanising bath temperature above 500 °C);
 - BG plants with a low average yearly production throughput;
 - BG plants with a high share of thin products.
 - To collect more information on the specific energy consumption levels in the case of cold rolling plants producing high-strength steel.
 - To collect more information on the specific energy consumption levels in wire drawing plants.
- Related to specific material consumption:
 - To collect more information on:
 - specific consumption of pickling and stripping acid for plants carrying out reglavanising of feedstock;
 - specific consumption of pickling acid in CR, HR, HDC and WD sectors;
 - specific consumption of plants carrying galvanising workpieces with a high specific surface area (e.g. tubes, cable trays);
 - the characterisation of the specific surface area (e.g. high specific surface area).
 - To collect further information on possible uses of oily sludge as well as on the characteristics of oily sludge in terms of contaminants (e.g. halogens, metals).
- Related to water consumption:

- To collect more information on the water consumption associated with cooling processes.
- To collect more information on the water consumption at the process step level.
- Related to emissions to water:
 - To collect more information on:
 - emission concentrations of dissolved Fe in waste water streams and its contribution to the total suspended solids and total Fe emission concentrations;
 - emission concentrations of Ni from plants producing austenitic stainless steel;
 - cases where FMP plants are receiving waste water from iron and steel production plants, in particular related to the pollutant loads.
 - To collect more information on the emission concentrations for indirect discharges of Hg and information on the potential origin of the Hg emissions.

Suggested topics for future R&D work

The Commission is launching and supporting, through its Research and Technological Development programmes, a series of projects dealing with clean technologies, emerging effluent treatment and recycling technologies and management strategies. Potentially, these projects could provide a useful contribution to future BREF reviews. Readers are therefore invited to inform the European IPPC Bureau of any research results which are relevant to the scope of this document (see also the fifth section of the Preface of this document).

11 ANNEXES

11.1 List of installations/plants that participated in the 2018 data collection for the FMP BREF review

Installation No.	Company name	Country	City / Town	FMP activities for which data were provided					CWWTP
				Hot Rolling	Cold Rolling	Wire Drawing	Hot Dip Coating	Batch Galvanising	
1	Zinkpower Brunn GmbH	AT	Brunn/Gebirge					X	
2	Verzinkerei Neumarkt GmbH	AT	Neumarkt					X	
3	OTN Oberflächentechnik GmbH	AT	St. Georgen					X	
4	Zinkpower Klagenfurt GmbH	AT	Klagenfurt					X	
5	Zinkpower Bergheim GmbH & Co. KG	AT	Bergheim					X	
6	Zinkpower Gratkorn GmbH	AT	Gratkorn					X	
7	Zinkpower Wiener Neustadt GmbH	AT	Theresienfeld					X	
8 (*)	Voestalpine Stahl GmbH / Voestalpine Grobblech GmbH	AT	Linz	X	X		X		X
10	Voestalpine Stahl Donawitz GmbH	AT	Donawitz	X					X
11	Voestalpine Schienen GmbH	AT	Donawitz	X					
12	Voestalpine Wire Rod Austria GmbH	AT	Donawitz	X					
14	Stahl- und Walzwerk Marienhütte GmbH	AT	Graz	X					
15	Voestalpine BÖHLER Edelstahl GmbH & Co KG	AT	Kapfenberg	X					
16	Voestalpine Tubulars GmbH & Co KG	AT	Kindberg	X					
17	Voestalpine Böhler Bleche GmbH & Co KG	AT	Mürzzuschlag		X				
18	Voestalpine Wire Austria GmbH	AT	Bruck/Mur			X			X
19	Voestalpine Böhler Edelstahl GmbH & Co-KG	AT	Kapfenberg - Deuchendorf	X					
20	Galva Power Houthalen	BE	Houthalen Helchteren					X	
21	Verzinkerij Lenssen	BE	Genk					X	
22	Limburgse Galvanisatie	BE	Maasmechelen					X	
23	Coatinc Ninove N.V.	BE	Ninove					X	
24	NV Bekaert SA	BE	Zwevegem			X			X
26	Aperam Genk	BE	Genk		X				
33	Segal	BE	Ivoz-Ramet				X		

Installation No.	Company name	Country	City / Town	FMP activities for which data were provided					CWWTP
				Hot Rolling	Cold Rolling	Wire Drawing	Hot Dip Coating	Batch Galvanising	
37	ArcelorMittal Belgium	BE	Ghent	X	X		X		
38	Aperam Stainless Belgium	BE	Châtelet	X					X
40	ArcelorMittal Belgium	BE	Ivoz-Ramet				X		
41	Arcelormittal	BE	Flémalle				X		X
45	Bilstein GmbH & CO. KG Hagen	DE	Hagen		X				
46	Fried. u. Herm. Lüling GmbH & Co.KG	DE	Altena			X			
48	Verticalgalva Voigt & Müller GmbH	DE	Kissing					X	
49	Voigt & Schweitzer Henssler GmbH & Co. KG	DE	Maintal					X	
50	Voigt & Schweitzer Landsberg/Halle GmbH	DE	Landsberg					X	
51	Wiegel Breitengüßbach Feuerverzinken GmbH	DE	Breitengüßbach					X	
52	Wiegel Feuchtwangen Feuerverzinken GmbH & Co KG	DE	Feuchtwangen					X	
53	Wiegel Graben Feuerverzinken GmbH & Co KG	DE	Graben					X	
54	ZinkPower Schoppsdorf GmbH & Co. KG	DE	Genthin OT Schoppsdorf					X	
55	Duferco Danish Steel A/S	DK	Frederiksværk	X					
56	NLMK DanSteel Ltd.	DK	Frederiksværk	X					
57	Coatinc Siegen GmbH	DE	Kreuztal					X	
58	Coatinc Würzburg GmbH	DE	Rottendorf					X	
61	Feuerverzinkung Holdorf GmbH & Co. KG	DE	Holdorf					X	
62	Feuerverzinkung Hannover GmbH & Co. KG	DE	Langenhagen					X	
63	ZinkPower Remels GmbH & Co. KG	DE	Uplengen-Remels					X	
64	ZinkPower Willi Kopf GmbH & Co. KG	DE	Schlierbach					X	
65	H.-J. Meyer Feuerverzinkungs GmbH & Co.KG	DE	Satow OT Groß Bölkow					X	
66	Sidenor Steel Industry S.A.	EL	Thessaloniki	X					
71	Galesa	ES	Cheste					X	
72	Galvanizaciones Aragonesas S.A.	ES	Zaragoza					X	
74	Megalta S.L.	ES	Porriño					X	
75	Galvanizados, S.A.	ES	Alcalá De Henares					X	
76	Retsa-II, S.L.	ES	Arteixo					X	

Installation No.	Company name	Country	City / Town	FMP activities for which data were provided					CWWTP
				Hot Rolling	Cold Rolling	Wire Drawing	Hot Dip Coating	Batch Galvanising	
84	Galvazinc S.L.	ES	Sotondrio- San Martín De Rey Aurelio					X	
85	Funtam	ES	Torrejón De Ardoz					X	
87	Celsa Group	ES	Laracha	X					
88	Acerinox Europa SAU	ES	Palmones	X	X				
89	Sidenor	ES	Basauri	X					X
90	Aceros inoxidables Olarra	ES	Loiu	X					X
91	ArcelorMittal España, S.A.	ES	Olaberia	X					X
92	Acería de Álava	ES	Amurrio	X					
94	ArcelorMittal España, S.A.	ES	Gijon/Aviles	X	X		X		X
96	ArcelorMittal España, S.A.	ES	Sagunto				X		X
97	ArcelorMittal España, S.A.	ES	Sestao	X					X
98	ArcelorMittal España, S.A.	ES	Etxebarri		X				
99	CelsaA	ES	Barcelona	X					X
100	Global Steel Wire S.A.	ES	Santander	X					
101	Nervacero S.A	ES	Valle De Trapaga	X					
102	Arcelormittal Belgium S.A.	BE	Liege		X				X
103	ArcelorMittal Ostrava S.A..	CZ	Ostrava	X				X	
105	Tubacex Amurrio	ES	Amurrio		X				
106	ArcelorMittal Fos sur Mer	FR	Fos-Sur-Mer	X					
108	ArcelorMittal	LU	Esch-Belval	X					X
109	ArcelorMittal	LU	Differdange	X					X
110	Tata Steel IJmuiden	NL	IJmuiden	X	X		X		X
111	ArcelorMittal Galati	RO	Galati	X	X		X		
112	Thyssenkrupp Steel Europe AG	DE	Duisburg	X					X
113	Vallourec Deutschland GmbH	DE	Düsseldorf	X					(**)
115	Waelzholz, C. D. Wälzholz GmbH	DE	Hagen		X				
116	Hille&Müller GmbH, Düsseldorf	DE	Düsseldorf		X				
118	ArcelorMittal Eisenhüttenstadt	DE	Eisenhüttenstadt	X					
119	ArcelorMittal Eisenhüttenstadt	DE	Eisenhüttenstadt		X				
120	ArcelorMittal Eisenhüttenstadt	DE	Eisenhüttenstadt				X		
121	ArcelorMittal Bremen GmbH / B.R.E.M.A Warmwalzwerk	DE	Bremen	X					

Installation No.	Company name	Country	City / Town	FMP activities for which data were provided					CWWTP
				Hot Rolling	Cold Rolling	Wire Drawing	Hot Dip Coating	Batch Galvanising	
	GmbH								
122	ArcelorMittal Bremen GmbH	DE	Bremen		X				
123	ArcelorMittal Bremen GmbH	DE	Bremen				X		
124	ArcelorMittal Hochfeld GmbH	DE	Duisburg	X					X
125	ArcelorMittal Hamburg GmbH	DE	Hamburg	X					X
126	Thyssenkrupp Steel Europe AG	DE	Duisburg	X					X
127	Thyssenkrupp Steel Europe AG	DE	Duisburg	X					X
128	Thyssenkrupp Steel Europe AG	DE	Duisburg		X				X
129	Thyssenkrupp Steel Europe AG	DE	Duisburg				X		X
130	Thyssenkrupp Steel Europe AG	DE	Dortmund		X				X
131	Thyssenkrupp Steel Europe AG	DE	Finnentrop				X		
132	Thyssenkrupp Steel Europe AG	DE	Dortmund				X		X
133	Mannstaedt GmbH	DE	Troisdorf	X					
134	AG der Dillinger Hüttenwerke	DE	Dillingen	X					
135	Saarstahl AG	DE	Burbach Saarbrücken	X					
136	Saarstahl AG	DE	Neunkirchen	X					
137	Saarstahl AG	DE	Völklingen	X					
138	B.E.S. Brandenburger Elektrostahlwerke GmbH	DE	Brandenburg	X					
139	H.E.S. Hennigsdorfer Elektrostahlwerke GmbH	DE	Hennigsdorf	X					
140	Badische Stahlwerke GmbH	DE	Kehl	X					
144	Outokumpu Nirosta GmbH	DE	Krefeld		X				
146	Benteler Steel/Tube GmbH	DE	Dinslaken	X					
147	Benteler Steel/Tube GmbH	DE	Paderborn	X					
151	Schmiedewerke Gröditz GmbH	DE	Gröditz	X					
152	Georgsmarienhütte GmbH	DE	Georgsmarienhütte	X					
155	Vallourec Deutschland GmbH	DE	Düsseldorf	X					(**)
156	Vallourec Deutschland GmbH	DE	Mülheim	X					
157	SSAB Europe	FI	Raaha	X					
158	Outokumpu Stainless Oy	FI	Tornio	X	X				

Installation No.	Company name	Country	City / Town	FMP activities for which data were provided					CWWTP
				Hot Rolling	Cold Rolling	Wire Drawing	Hot Dip Coating	Batch Galvanising	
159	SSAB Europe Oy	FI	Hämeenlinna		X		X		
160	Al Babbain Power and Telecommunication	FR	Saint-André-Les-Vergers					X	
161	GAT Galva Anjou Touraine	FR	Noyant					X	
162	Groupe Prestia	FR	Yerville					X	
163	Galva union	FR	Senozan					X	
164	Groupe Prestia	FR	Carpiquet					X	
165	Galva union	FR	Chabeuil					X	
166	Galvametal	FR	Embreville					X	
167	Galvatlantique	FR	La Rochelle					X	
168	GTS Galvanisation et traitement de surface	FR	Loudun					X	
169	Groupe Prestia	FR	La-Chapelle-Caro					X	
170	Aperam Stainless France	FR	Isbergues		X				
171	NLMK	FR	Strasbourg				X		
172	Dillinger Hutte	FR	Dunkirk	X					X
173	Alpa S.A.S.	FR	Porcheville	X					
174	SAM Neuves-Maisons	FR	Neuves Maisons	X					X
175	ArcelorMittal / Industeel France	FR	Le Creusot	X					X
177	Ugitech S.A.	FR	Ugine	X					
178	Arcelormittal	FR	Dunkirk	X					
179	Arcelormittal Atlantique et Lorraine	FR	Florange	X	X		X		
180	Arcelormittal Atlantique et Lorraine	FR	Grande Synthe		X		X		X
183	Mita SPA	IT	Conseve					X	
184	Zincheria Valbrenta S.p.A.	IT	Rosà					X	
185	Zimetal srl	IT	Solero					X	
186	Zincatura Di Cambiano srl	IT	Cambiano					X	
187	Zincol Italia S.p.A.	IT	S Vito Al Tagliamento					X	
188	Mangani Marco	IT	Cesena					X	
189	Zincatura Padana S.p.A	IT	Reggio Emilia					X	
190	Zincheria Seca S.p.A.	IT	Ala					X	
191	Olfez SpA	IT	Seriante					X	
192	Galvan SpA	IT	Baranzate Di Bollate					X	
193	ILVA S.p.a. in A.S.	IT	Taranto	X	X		X		X

Installation No.	Company name	Country	City / Town	FMP activities for which data were provided					CWWTP
				Hot Rolling	Cold Rolling	Wire Drawing	Hot Dip Coating	Batch Galvanising	
194	ILVA SPA IN AS	IT	Novi Ligure		X		X		X
195	ILVA SPA IN AS	IT	Genova		X		X		X
196	Acciaierie Bertoli Safau S.p.A.	IT	Udine	X					
197	Acciai Speciali Terni S.p.A.	IT	Terni	X	X				X
198	Dalmine S.p.A.	IT	Piombino					X	
199	Travi e Profilati di Pallanzeno Srl - Duferdofin Nucor	IT	Pallanzeno	X					
200	AFV Acciaierie Beltrame S.p.A	IT	Vicenza	X					
201	Arcelormittal Piombino	IT	Piombino		X		X		X
202	Alfa Acciai S.p.A.	IT	Brescia	X	X				X
203	Feralpi Siderurgica S.p.A.	IT	Lonato Del Garda	X					X
204	dott. Carlo Mazzoleni	IT	Bergamo				X		X
205	Dalmine S.p.A.	IT	Dalmine	X					X
206	Dalmine S.p.A.	IT	Arcore	X					
207	ArcelorMittal Poland	PL	Sosnowiec	X					
208	ArcelorMittal Poland	PL	Chorzów	X					
209	ArcelorMittal	PL	Kraków		X				
210	ArcelorMittal Poland	PL	Sosnowiec		X				
211	ArcelorMittal Poland	PL	Kraków				X		
213	CMC Poland	PL	Zawiercie	X					
217	Huta Bankowa Sp. zo.o.	PL	Dąbrowa Górnicza	X					
218	Celsa "Huta Ostrowiec" Sp. z o.o.	PL	Ostrowiec Świętokrzyski	X					
219	Celsa "Huta Ostrowiec" Sp. z o.o.	PL	Ostrowiec Świętokrzyski	X					
220	ISD Huta Częstochowa Sp. z o.o.	PL	Częstochowa	X					
221	ArcelorMittal Poland S.A.	PL	Dąbrowa Górnicza Katowice	X					
222	ArcelorMittal Poland S.A.	PL	Kraków	X					
223	ArcelorMittal Poland S.A.	PL	Świętochłowice				X		
224	Eurogalva, Galvanização e Metalomecânica, SA	PT	Fiaes Santa Maria Da Feira					X	
225	Lusosider Aços Planos S.A	PT	Paio Pires Seixal		X		X		
226	Irmãos Silvas, S.A. (Metalgalva)	PT	Santiago De Bougado					X	

Installation No.	Company name	Country	City / Town	FMP activities for which data were provided					CWWTP
				Hot Rolling	Cold Rolling	Wire Drawing	Hot Dip Coating	Batch Galvanising	
			Trofa						
227	Gamil– Galvanização do Minho, Lda.	PT	Neiva Viana Do Castelo					X	
228	Galme – Galvanização e Metalização, Lda.	PT	Carregado Alenquer					X	
229	Socitrel - Sociedade Industrial de Trefilaria, SA	PT	São Romão Do Coronado Trofa			X	X		
230	S.N. Seixal – Siderurgia Nacional S.A Megasa	PT	Seixal	X					
231	S.N. Maia - Siderurgia Nacional S.A Megasa	PT	Maia	X					
232	Outokumpu Stainless AB	SE	Torshälla Nyby		X				
233	DOT AB fd Jiwe Varmförzinkning AB	SE	Sölvesborg					X	
234	Vadstena Varmförzinkning AB	SE	Vadstena					X	
235	Södertälje Varmförzinkning AB	SE	Södertälje					X	
236	Degerfors Förzinkning AB	SE	Degerfors					X	
238	Outokumpu Stainless AB	SE	Avesta	X	X				
239	Erasteel Kloster AB	SE	Långshyttan	X					
240	Ovako Bar AB	SE	Smedjebacken	X					X
241	Ovako Bar AB	SE	Boxholm	X					X
242	Ovako Sweden AB	SE	Hofors	X	X				X
243	SSAB EMEA AB	SE	Oxelösund	X					
244	SSAB Europe AB	SE	Borlänge	X	X				
245	Fagersta Stainless AB	SE	Fagersta	X		X			
246	AB Sandvik Materials Technology	SE	Sandviken	X	X				X
247	Outokumpu Stainless AB	SE	Degerfors	X					
248	Uddeholms AB	SE	Hagfors	X					X
249	U.S.Steel Košice, s.r.o.	SK	Košice	X	X		X		X
251	Wedge Group Galvanising Ltd	UK	Heywood					X	
252	Wedge Group Galvanising Ltd	UK	Witham					X	
254	Wedge Group Galvanising Ltd	UK	Eastleigh					X	
255	Wedge Group Galvanising Ltd	UK	Worksop					X	
257	Wedge Group Galvanising Ltd	UK	Hull					X	
258	Wedge Group Galvanising	UK	Willenhall					X	

Installation No.	Company name	Country	City / Town	FMP activities for which data were provided					CWWTP
				Hot Rolling	Cold Rolling	Wire Drawing	Hot Dip Coating	Batch Galvanising	
	Ltd								
259	Joseph Ash Galvanising Ltd	UK	Corby					X	
260	Joseph Ash Galvanising Ltd	UK	Chesterfield					X	
261	Joseph Ash Galvanising Ltd	UK	Telford					X	
262	Joseph Ash Galvanising Ltd	UK	Bilston					X	
263	Tata Steel UK Ltd	UK	Shotton				X		X
265	Tata Steel UK Ltd	UK	Port Talbot	X					
266	Outokumpu Stainless Ltd	UK	Sheffield	X					
267	Speciality Steel UK Ltd T/A Liberty Speciality Steels	UK	Sheffield	X					
268	Speciality Steel UK Ltd T/A Liberty Speciality Steels	UK	Rotherham	X					
269	Speciality Steel UK Ltd T/A Liberty Speciality Steels	UK	Rotherham	X					
270	British Steel Limited	UK	Scunthorpe	X					
271	Celsa Manufacturing UK Limited	UK	Cardiff	X					
272	Celsa Manufacturing UK Limited	UK	Cardiff	X					
273	ArcelorMittal Warszawa Sp.z	PL	Warsaw	X					
275	British Steel Limited	UK	Saltburn By The Sea	X					
276	Caverion Industria Oy, Ylivieska workshop	FI	Ylivieska					X	
277	Dansk Overflade Teknik	DK	Køge					X	
279	Rotocoat Kampen B.V.	NL	Kampen					X	
280	Rotocoat Kampen B.V.	NL	Heerhugowaard					X	
281	Rotocoat Kampen B.V.	NL	Wolvega					X	
282	Rotocoat Dieren B.V.	NL	Spankeren					X	
283	Coatinc Alblasserdam B.V.	NL	Alblasserdam					X	
284	Coatinc Groningen B.V.	NL	Groningen					X	
285	Coatinc Mook B.V.	NL	Mook					X	
287	Celsa Armeringsstål	NO	Mo I Rana	X					
288	Ferriere Nord Spa	IT	Osoppo	X					
289	Irpinia Zinco Srl	IT	Lacedonia					X	
292	DOT A/S	DK	Fasterholt					X	
293	DOT A/S	DK	Ferritslev					X	
294	Industrial Gonabe S.L.	ES	Castilla y León					X	
295	Wiegel CZ žárové zinkování s.r.o.	CZ	Velké Meziříčí					X	

Installation No.	Company name	Country	City / Town	FMP activities for which data were provided					CWWTP
				Hot Rolling	Cold Rolling	Wire Drawing	Hot Dip Coating	Batch Galvanising	
296	Wiegel Žebrák žárové zinkování s.r.o.	CZ	Zebrak					X	
297	Trinecke Zelezarny a.s.	CZ	Kladno	X					
298	Vítkovice Steel, a.s.	CZ	Ostrava	X					
300	Ovako Sweden AB	SE	Hällefors	X		X			X
301	ZDB Dratovna a.s.	CZ	Bohumín			X			
<p>NB: X = The installation provided questionnaire for the sector. (*) = This installation is identified for the HR sector as 08-09. (**) = The CWWTP is shared by the installations number 113 and 155. Source: [16, FMP TWG 2018].</p>									

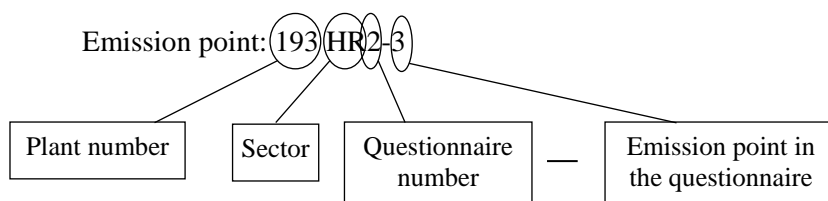
11.2 Explanation of emission point identification

a. Emission point identification for emissions to air and residues

The data are not plotted using the plant names, but using an ‘identification code’.

For HR, CR, WD and HDC, each point on the x-axis in the graphs represents one emission point (e.g. stack) of a specific plant. For example, emission point 100 HR-2 corresponds to emission point 2 of the HR plant 100. The emission points for each plant were listed by the operators in the questionnaire sheet ‘Points of emission to air’. Each emission point with the specific type of emissions (e.g. dust emissions from mechanical treatment) appears in the graph as one point on the x-axis, with the minimum, average and maximum values on the y-axis. Hence, there may be several emission points for the same plant in the graph, if several emission points with the same type of emission exist in the plant, e.g. 100 HR-1, 100 HR-2. In some cases, more than one questionnaire was supplied for the same installation (corresponding to different plants) and a number was added next to the sector letters to denote this, e.g. 193 HR2-3.

Summarising the above, the emission point code comprises the following:



As for some emission points, both periodic and continuous measurements are reported, the letter ‘C’ is added at the end of the emission point code for all points with continuous measurement data. In this case, plants with both types of measurements will appear as two emission points in the graphs (e.g. emission points 37 HR-1 and 37 HR-1C for NO_x and CO emissions).

For BG it is more common to have only one emission point per process and/or production line, therefore the plant codification differs slightly. It basically consists of the plant number plus an extension ‘-1’ or ‘-2’ indicating whether this is referring to line 1 or line 2 for plants that have more than one production line (plants with only one line are only represented by the ‘plant number’). The plant numbers are the numbers allocated to each plant during the nomination of plants to take part in the data collection.

Example BG plant code: 75-2 (Plant 75, line 2).

For the graphs of residues, the same code is used, except for the last part related to the emission point, which is exclusively for emissions to air.

b. Plant/line/emission point identification for emissions to water

Releases (waste water streams) from FMP plants (HR, CR, WD and HDC) were separated in the questionnaires into two types. Those leaving the plant without plant-specific treatment (Not-Treated) and those after plant-specific treatment (Treated). Monitoring data were requested for the releases discharged to the environment, directly to a receiving body, or indirectly via an off-site WWTP (see Figure 11.1). Releases from an on-site CWWTP (treating waste waters from various plants, either FMP or non-FMP) were considered in a separate CWWTP questionnaire.

In the figures, the code for emissions to water comprises the following:

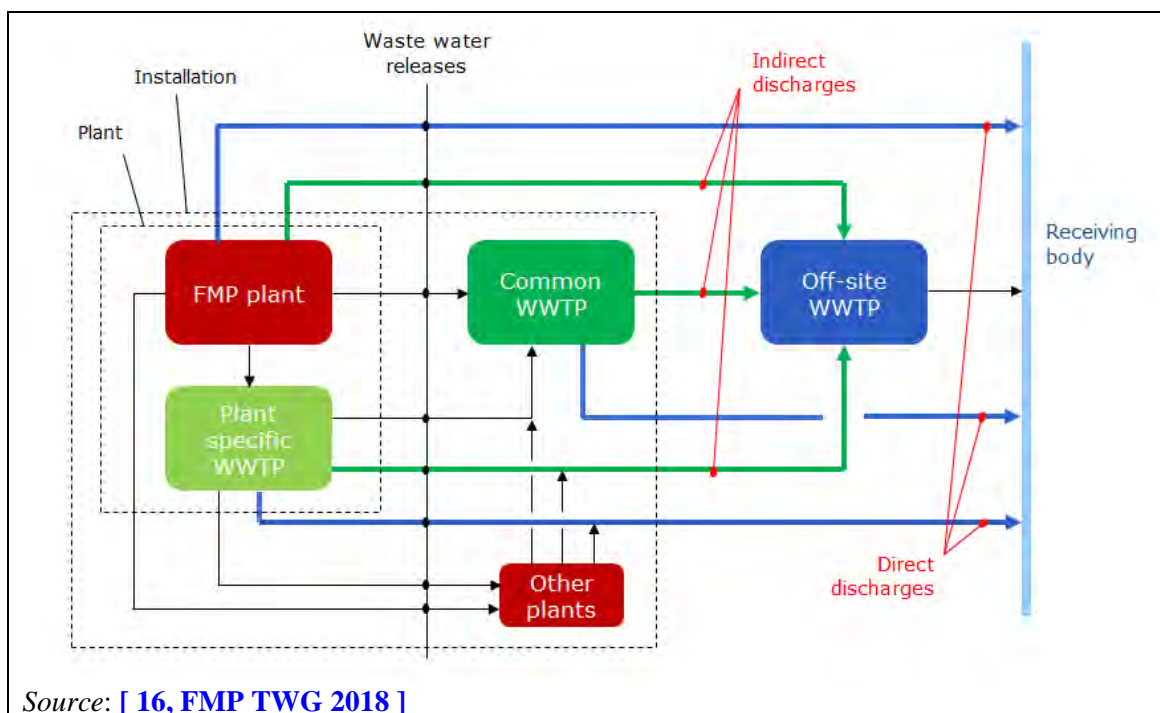
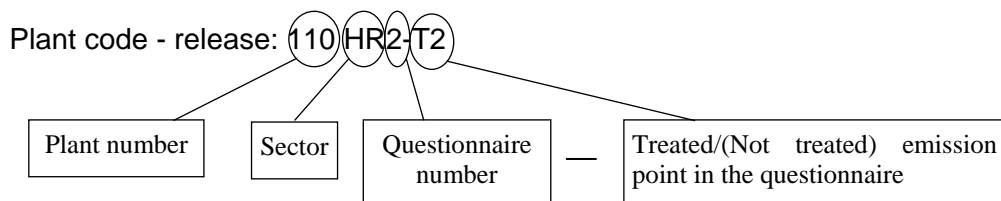


Figure 11.1: Schematic of a generic waste water system

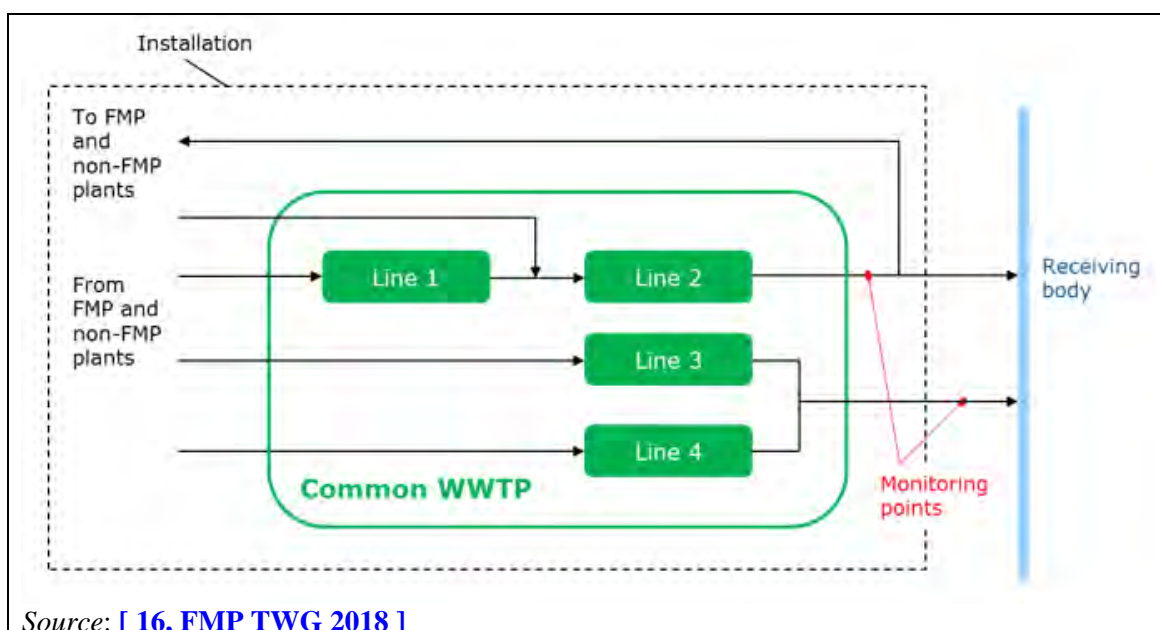


Figure 11.2: Schematic of different line layouts in a common waste water treatment plant

c. Plant/line identification for energy consumption, water consumption and material consumption

In the figures related to energy, water and material consumption, confidential information provided by the plants has been used. In order to preserve the confidentiality of the plants, a random sorting number has been used in all the figures. This means that the sorting number used in these figures does not correspond to the installation number given in the table for the list of installations/plants that participated in the 2018 data collection.

11.3 Information on steel grade, steel category and steel products in the FMP industrial sector

11.3.1 Steel grades

The steel grade is linked to the chemical composition, the structure and the crystallography of the product. Within the questionnaires used in the FMP data collection, steel grades have been defined for four principal categories:

- **Carbon steel non alloy**, for which the content of alloy elements is lower than 0.4%, except for silicon (< 0.6%) and manganese (<1.65%);
- **Carbon steel low alloy**, for which the content of each alloy element is lower than 5%;
- **Stainless steel**, which is also considered as an high alloy steel;
- **High alloy steels**, other than stainless steel for which the content of some alloy elements is over 5%.

Carbon steel non alloy: This first category covers a wide range of utilisation for long and flat products. It includes the ultra low carbon steel, medium carbon steel (0.3% < carbon content <0.6%) and high carbon steel (carbon content >0.6%) as well as the microalloy such as High Strength Low Alloy (HSLA) steels and advanced high strength steels. In the flat product category, the main cold rolled carbon steels are: steels for packaging (very thin gages) and sheets for construction, general industry, automotive, appliances. In the category long products, the main carbon steel products are rails and improved machinability and free-cutting steels. For this type of product, a lead content (up to 0.35%) is used for easier machining, but sulfur can also be used (up to 0.4%).

Carbon steel low alloy: The main alloy elements (each element <5%) are Cr, Co, Cu, Mn, Mo, Nb, Ni, Ti, W, V, P and Si. These types of steel have improved quenching and improved mechanical properties and includes spring steels, bearings steels and wear resistant steels. Electrical steels, which contain Si from 1% up to 3%, also belong to this category. Some HSLA, High Strength and Advanced High Strength Steels, especially for flat products can also belong to this category.

Stainless steel: There are four main classes of stainless steels: ferritic, austenitic, martensitic and duplex. All of them contain chromium (10-23%). Austenitic steel also contains around 8-10% of nickel. In hot rolling, the process of production of stainless is very similar to the production process of carbon steels, even if there are different heating patterns. For flat products, however, the processes are quite different, compared to the carbon steels. In addition, both for hot and cold processes, stainless steels have a high level of yield strength for the deformation and specific annealing cycles.

Other high alloy steels: The main alloy elements (> 5% for some of them) are Cr, Mo, W, V, Mn, Ni. This category contains, for example, the following type of products: high speed, moulds, tools, refractory and raring (martensitic-aging) steels.

In addition to the four principal steel grades described above, electrical steels and high strength steel should also be considered as special steel grades.

Electrical steels: Electrical steels of flat products are produced following the hot rolling route followed by cold rolling. They are tailored to get specific properties which includes: low electrical power losses and high magnetic permeability. Electrical steels are usually produced with a silicon content within the range 2% to 3.2%. In general, they can be classified as part in the category of carbon steel low alloy. Usually, two main families of electrical steel are distinguished:

- Electrical steels with standard or improved electrical properties, designated as 'non grain oriented' (NGRO), or more usually named 'non oriented' (NONO) steel. The

production of this type of electrical steel does not require any specific processing steps in hot rolling, however in cold rolling, it is sometimes necessary to carry out a first annealing (batch annealing) step before pickling and cold rolling. Also, in the case of laminated sheets which may be directly used by the customer, the final process of the cold plant includes a continuous annealing step (with temperatures up to 1050°C) followed by a varnish coating step.

- Electrical steels with optimised electrical properties, named 'grain oriented' (GO), with a silicon content of 3%. These steels are processed in such a way that the optimised properties are developed in the rolling direction. This needs a tight control of the crystal orientation during the production process. In hot rolling, it is necessary to operate at very high reheating temperatures (at around 1400°C), with specific devices in the furnace in order to recover the liquid scale, and very specific rolling patterns with high temperatures, both in the roughing and the finishing mill. In a cold rolling plant, very specific process steps are also required such as: annealing and pickling before cold rolling; cold rolling using a reverse multi-rolls stand (similar to stainless steel); continuous decarburising and annealing line with a final batch annealing step.

High-Strength Steels: These types of steel have improved or high mechanical characteristics related to strength such as yield strength (R_e) and tensile strength (R_m). These high strength steels are mainly developed for automotive applications. High strength steels generally exhibit a yield strength value > 420 MPa and includes the following products HSLA (High Strength Low Alloy), FB (ferrite-Bainite), TRIP (TRansformation Induced Plasticity), DP (Dual Phase), CP (Complex Phase), MS (Martensite Steel), TWIP (TWin Induced Plasticity), AHSS (Advanced High Strength Steels), Mn-B+HF (Manganese and Boron + Hot Forming). All these high strength steels are more difficult to be rolled and processed in a cold rolling plant, even if for some of them (TRIP, TWIN, MnB+HF) the final mechanical properties are obtained after transformation by the customer. Compared to the classical carbon mild steel, all these high strength steels requires higher energy consumption for the cold deformation, and very specific annealing thermal cycles.

11.3.2 Steel products

Depending on the steel category (Flat / Long), the list of steel products in the FMP industrial sector can be summarised as follows:

Steel products in hot rolling (Flat)

- Hot rolled coils (all steel grades);
- Hot rolled coils pickled and oiled (HRPO - carbon steel only);
- Hot rolled coils for further processing in cold rolling (all steel grades);
- Hot rolled coils for further processing in hot dip coating of sheets;
- Heavy plates (all steel grades).

Steel products in hot rolling (Long)

- Beams (mainly carbon steels non alloy);
- Rails (mainly carbon steels non alloy);
- Billets (all steel grades);
- Bars (all steel grades);
- Rods (all steel grades);
- Rods to be further processed in wire drawing (all steel grades);
- Tubes (mainly carbon non alloy and stainless).
- Rings (all steel grades).

Steel products in cold rolling (Flat)

All the products to be processed in cold rolling are coming from the hot strip mill as hot rolled coils. The final products are cold rolled coils (CRC) which are classified first according to the steel grade and their application.

Carbon steels

1. CRC for construction and general industry:
 - Delivered directly as CRC;
 - CRC for further processing in hot dip coating of sheets (mainly for construction);
 - CRC for further electro zinc coating (quite rare and only for narrow strips);
 - CRC for automotive;
 - Delivered directly as CRC;
 - CRC for further processing in hot dip coating of sheets (the most frequent);
 - CRC for further electro zinc coating;
2. CRC for packaging:
 - Delivered directly as CRC;
 - CRC for further electro tin plating (tin plate);
 - CRC for further electro chromium plating (tin free steel);
3. CRC for electrical applications:
 - NONO, Non Oriented Grain electrical steel;
 - GO, Grain Oriented electrical steel.

Stainless steels

Cold Rolled Coils in the different classes of steel grades: ferritic, austenitic, martensitic and duplex

Steel products in wire drawing

In a wire drawing plant, the descaling process and the heat treatment is depending on the steel quality. For carbon steel non alloy, the carbon content (low, medium, high) is discriminant. Carbon steel low alloy might have specific treatment as well.

Wire

- Carbon steel. Includes in particular, low, medium and high carbon content, and some low alloy;
- Stainless steel. Includes all the different classes of steel grades;
- Other high alloy steels (only for very specific applications).

Steel products in hot dip coating

Hot dip coating concerns only carbon steels. Products are used in construction, automotive, general industry and appliances. When the process begins with hot rolled coils, the coil is pickled then heated to a suitable temperature for coating. When the process begins with cold rolled coils, the coil is cleaned, then annealed and partially cooled down to a suitable temperature for coating. In the case of flat products, different types of coating are used, but mainly two families can be distinguished:

- Zinc base coating, which includes, galvanised, galvanized, and others with addition of aluminium and/or magnesium;
- Aluminium base coating, including other additions such as zinc and/or silicon.

In the case of wire drawing, the wire is cleaned, then follow a heat treatment, an immersion in the coating bath, and a final heat treatment.

11.4 Information on the reported use of BAT in the various FMP industrial sectors

The following table contains information as submitted by the FMP TWG on the current use of techniques that are presented in the BAT conclusion chapter of this document for the various FMP sectors. The information in this table represents the available knowledge of the FMP TWG on which BAT are currently used (at the time of writing) in the various FMP sectors in the Member States of the European Union. It cannot be considered an indication of the applicability of those BAT as per IED Article 3(10)(b). Applicability information can be found in the applicability clauses of the BAT conclusions chapter of this document (Chapter 9) as well as in the detailed descriptions of the techniques in Sections X.4 for the sector-specific techniques to be considered in the determination of the BAT (i.e. Sections 2.4, 3.4, 4.4, 5.4 and 6.4) or in Chapter 8 for techniques applied in more than one sector.

Table 11.1: Information on the reported use of BAT in the various FMP sectors

BREF section number	Title of technique	Hot rolling	Cold rolling	Wire drawing	Continuous hot dip coating	Batch galvanising	Relevant BAT number in Chapter 9
2.4.1.1	Enclosed scarfing (other than manual scarfing) combined with air extraction and waste gas treatment	U	N	N	N	N	42a
2.4.1.2	Enclosed grinding combined with air extraction and waste gas treatment	U	N	N	N	N	42a
2.4.1.3	Computer-aided quality control (CAQC)	U	N	N	N	N	40a
2.4.1.4	Edging or trimming of wedge-type slabs	U	N	N	N	N	40c
2.4.1.5	Slab slitting	U	N	N	N	N	40b
2.4.2.1	Process gas management system	U	U	N	U	N	20b, 21, 22
2.4.2.5	Oxy-fuel combustion	U	N	N	U	N	11h, 22h
2.4.2.6	Flameless combustion	U	N	N	U	N	11i, 22g
2.4.2.7	Pulse-fired burner	U	N	N	N	U	11j
2.4.2.8	Low-NO _x burners	U	U	U	U	U	22d
2.4.2.9	Selective catalytic reduction (SCR)	U	U	N	N	N	22i
2.4.2.10	Selective non-catalytic reduction (SNCR)	U	N	N	N	N	22j
2.4.2.11	Flue-gas recirculation (FGR)	U	N	N	N	N	22e
2.4.2.14	Heat recovery from skids cooling	U	N	N	N	N	38c
2.4.2.15	Heat conservation during transfer of feedstock	U	N	N	N	N	38d
2.4.2.16	Hot/direct charging	U	N	N	N	N	38b
2.4.2.17	Near-net-shape casting for thin slabs followed by rolling	U	N	N	N	N	38a, 39f
2.4.2.18	Near-net-shape casting for beam blanks followed by rolling	U	N	N	N	N	38a, 39f
2.4.3.1	Water spray descaling triggered by sensors	U	N	N	N	N	19h
2.4.4.1	Sizing press	U	N	N	N	N	38g, 39a
2.4.5.1	Computer-aided rolling optimisation	U	U	N	N	N	39b, 44c
2.4.6.1	Coil boxes	U	N	N	N	N	38e, 39d

2.4.6.2	Coil recovery furnaces	U	N	N	N	N	38f
2.4.7.1	Crop optimisation	U	N	N	N	N	41a
2.4.7.11	Control of the feedstock shape during rolling	U	N	N	N	N	41b
2.4.7.14	Three-roll stand	U	N	N	N	N	39e
2.4.7.2	Reduction of the rolling friction	U	N	N	N	N	39c
2.4.7.8	Air extraction as close as possible to the source for mechanical processes and welding combined with waste gas treatment	U	N	N	N	N	42b
2.4.10.1	Treatment of grinding sludge	U	U	N	N	N	37b
2.4.10.1	Recycling of worn working rolls	U	U	N	N	N	37c
2.4.11.2	Treatment and reuse of scale- and oil-bearing process water in hot rolling	U	N	N	N	N	19g
3.4.1.2	Air extraction as close as possible to the source for emissions from decoiling and mechanical predescaling	N	U	N	N	N	46
3.4.2.1	Continuous rolling for low-alloy and alloy steel	N	U	N	N	N	44a
3.4.2.3	Optimal choice of rolling oil and emulsion system	U	U	N	N	N	45d
3.4.2.4	Reduction of the rolling friction	N	U	N	N	N	44b
3.4.2.5	Monitoring and adjustment of the rolling emulsion quality	N	U	N	N	N	45a
3.4.2.6	Prevention of contamination of the rolling emulsion	N	U	N	N	N	45b
3.4.2.7	Minimisation of oil/rolling emulsion consumption	N	U	N	N	N	45e
3.4.2.8	Cleaning and reuse of the rolling emulsion	N	U	N	N	N	45c
3.4.2.9	Treatment of spent rolling emulsion	N	U	N	N	N	45c
3.4.2.10	Air extraction as close as possible to the source for emissions from rolling	N	U	N	N	N	48
3.4.3.4	Low-NO _x burner for annealing furnaces	N	U	N	N	N	22d
3.4.3.5	Selective catalytic reduction (SCR) in continuous annealing lines	N	U	N	N	N	22i

3.4.4.2	Dry tempering and low-volume lubrication in wet tempering	N	U	N	N	N	47
3.4.4.4	Air extraction as close as possible to the source for emissions from wet tempering	N	U	N	N	N	48
3.4.5.2	Air extraction as close as possible to the source for emissions from levelling and welding	N	U	N	N	N	46
3.4.6.1	Cleaning and reuse of grinding emulsion	U	U	N	N	N	37a
4.4.1.2	Recovery and reuse of shot blast media	U	N	U	N	N	34h
4.4.3.1	Enclosed drawing machine combined with air extraction and abatement	N	N	U	N	N	52a
4.4.3.2	Air extraction in wire drawing as close as possible to the emission source	N	N	U	N	N	52b
4.4.4.2	Cleaning of drawing lubricant / coolant	N	N	U	N	N	50
4.4.6.1	Floating protective layers or tank covers in the lead baths	N	N	U	N	N	49, 51b
4.4.6.2	Minimisation of carry-over of lead	N	N	U	N	N	51a
4.4.6.3	Air extraction as close as possible to the source and treatment of lead bath emissions	N	N	U	N	N	51c
4.4.8.2	Air extraction as close as possible to the source for emissions from oil quench baths	N	N	U	N	N	53a
5.4.1.1.3	Use of a direct-flame furnace in the case of hot dip coating of sheets	N	N	N	U	N	12b
5.4.1.3.1	Air knives for coating thickness control	N	N	N	U	N	56a
5.4.1.3.2	Stabilisation of the strip	N	N	N	U	N	56b
5.4.1.5.1	Cleaning and reuse of the phosphating or passivation solution	N	N	N	U	N	17a
5.4.1.5.2	Air extraction as close as possible to the source from chemical baths and tanks in post-treatment (i.e. phosphating and passivation)	U	U	U	U	U	28a

5.4.1.5.3	Closed tanks combined with air extraction in the case of continuous post-treatment	N	N	N	U	N	28b
5.4.1.5.4	Minimisation of drag-out of chemical solution	N	N	N	U	N	17c
5.4.1.5.5	Use of roll coaters for strips	N	N	N	U	N	17b
5.4.3.2.3	Air or nitrogen wiping	N	N	N	U	N	57a
5.4.3.2.4	Mechanical wiping	N	N	N	U	N	57b
6.4.2.1	Separated pickling and stripping	N	N	N	N	U	58
6.4.2.3	Zinc removal by ion exchange	N	N	N	N	U	59
6.4.2.5	Zinc removal by solvent extraction	N	N	N	N	U	59
6.4.2.6	Restricted operating range for hydrochloric acid open pickling baths	N	N	N	N	U	62d
6.4.2.7	Extraction by lateral hood or lip extraction	N	N	N	N	U	62b
6.4.2.8	Enclosed pretreatment section with extraction	N	N	N	N	U	62a
6.4.5.1	Optimised dipping time	N	N	N	N	U	60
6.4.5.2	Slow withdrawal of workpieces from the bath	N	N	N	N	U	60
6.4.5.4	Recovery and use of zinc-containing particles from steam blow-off (tube finishing)	N	N	N	N	U	61
8.1.1	Environmental management system (EMS)	U	U	U	U	U	1
8.1.3	Chemicals management systems	U	U	U	U	U	3
8.2.2	Monitoring of emissions to water	U	U	U	U	N	8
8.2.3	Monitoring of channelled emissions to air	U	U	U	U	U	7
8.3.1	Set-up and implementation of a plan for the prevention and control of leaks and spillages	U	U	U	U	U	4a
8.3.2	Use of oil-tight trays or cellars	U	U	U	U	U	4b
8.3.3	Prevention and handling of acid spillages	U	U	U	U	U	4c

8.3.5	Set-up and implementation of an OTNOC management plan to reduce emissions during OTNOC	U	U	U	U	U	5
8.4.1	Avoiding the use of hexavalent chromium compounds in passivation	N	N	N	U	U	9
8.5.1	Energy efficiency plan and energy audits	U	U	U	U	U	10a
8.5.2	Energy balance record	U	U	U	U	U	10b
8.5.3.1	Optimum furnace design for feedstock heating	U	U	U	U	N	11a
8.5.3.2	Combustion optimisation	U	U	U	U	U	11d
8.5.3.3	Furnace automation and control	U	U	U	U	U	11e
8.5.3.4	Process gas management system	U	U	N	U	N	11f
8.5.3.5	Batch annealing with 100 % hydrogen	N	U	U	N	N	11g
8.5.3.6	Optimum galvanising kettle design	N	N	N	N	U	11b
8.5.4.1	Feedstock preheating	U	N	N	U	N	11k
8.5.4.2	Drying of workpieces	N	N	N	N	U	11l
8.5.4.3	Preheating of combustion air	U	U	N	U	U	11m
8.5.4.4	Waste heat recovery boiler	U	U	N	U	N	11n
8.6.1.1	Use of feedstock with low oil and grease contamination	N	N	U	U	U	12a
8.6.1.2	General techniques for increased degreasing efficiency	N	U	U	U	U	12c
8.6.1.3	Minimisation of drag-out of degreasing solution	N	U	U	U	U	12d
8.6.1.4	Reverse cascade degreasing	N	U	U	U	U	12e
8.6.1.5	Cleaning and reuse of the degreasing solution	N	U	U	U	U	12f
8.6.2.1	Acid heating with heat exchangers or by submerged combustion	N	U	U	N	U	13a, 13b
8.6.2.2	Minimisation of steel corrosion	N	U	U	N	N	14a
8.6.2.3	Mechanical pre-descaling	N	U	U	N	N	14b, 46
8.6.2.4	Electrolytic prepickling for high-alloy steel	N	U	N	N	N	14c
8.6.2.5	Rinsing after alkaline degreasing	N	N	N	N	U	14d

8.6.2.6	General techniques for increased pickling efficiency	N	U	U	N	U	14e
8.6.2.7	Cleaning of the pickling bath and reuse of acid acid	N	U	U	N	U	14f
8.6.2.8	Reverse cascade pickling	N	U	U	N	N	14g
8.6.2.9	Minimisation of drag-out of pickling acid	N	U	U	N	U	14h
8.6.2.10	Turbulence pickling	N	U	N	N	N	14i
8.6.2.11	Use of pickling inhibitors	N	U	U	N	U	14j
8.6.2.12	Activated pickling in hydrochloric acid pickling	N	U	N	N	U	14k
8.6.3.1	Rinsing of workpieces after pickling	N	N	N	N	U	15a
8.6.3.2	Optimised fluxing operation	N	N	N	N	U	15b
8.6.3.3	Iron removal and reuse of the fluxing solution	N	N	N	N	U	15d
8.6.3.4	Recovery of salts from the spent fluxing solution for production of fluxing agents	N	N	N	N	U	15e
8.6.3.5	Minimisation of drag-out of fluxing solution	N	N	N	N	U	15c
8.6.4.1	Reduction of the generation of bottom dross	N	N	N	U	U	16a
8.6.4.2	Prevention, collection and reuse of zinc splashes in batch galvanising	N	N	N	N	U	16b
8.6.4.3	Reduction of the generation of zinc ash	N	N	N	U	U	16c
8.6.5	Techniques to recover spent pickling acids	U	U	U	N	U	18
8.7.1	Water management plan and water audits	U	U	U	U	N	19a
8.7.2	Segregation of water streams	U	U	U	U	N	19b
8.7.3	Minimisation of hydrocarbon contamination of process water	U	U	U	U	N	19c
8.7.4	Reuse and/or recycling of water	U	U	U	U	N	19d
8.7.5	Reverse cascade rinsing	U	U	U	U	U	19e
8.7.6	Recycling or reuse of rinsing water	U	U	U	U	U	19f

8.8.1.1	Demister	U	U	U	U	U	23c, 24c, 28d, 48b, 53b
8.8.1.2	Electrostatic precipitator (ESP)	U	U	N	N	N	42c
8.8.1.3	Fabric filter	U	U	U	N	U	26e, 42d, 46b, 51d, 52c
8.8.1.4	Selective catalytic reduction (SCR) – Acid recovery	N	U	N	N	N	29e
8.8.1.6	Optimisation of the SCR design and operation	U	U	N	N	N	22k, 25g, 29f
8.8.1.7	Wet scrubbing	U	U	U	U	U	23b, 24c, 28c, 42e
8.8.2.1	Use of electricity generated from fossil-free energy sources for heating	U	U	U	U	U	20, 21, 22
8.8.2.1	Use of a fuel or a combination of fuels with low dust or ash content	U	U	U	U	U	20a
8.8.2.3	Limiting the entrainment of dust	U	N	N	U	N	20b
8.8.2.4	Use of a fuel or a combination of fuels with low sulphur content	U	U	U	U	U	21
8.8.2.5	Use of a fuel or a combination of fuels with low NO _x formation potential	U	U	U	U	U	22a
8.8.2.6	Furnace automation and control	U	U	U	U	U	22b
8.8.2.7	Combustion optimisation	U	U	U	U	U	22c
8.8.2.8	Low-NO _x burner	U	U	U	U	U	22d
8.8.2.9	Flue-gas recirculation	U	N	N	N	N	22e
8.8.2.10	Limiting the temperature of air preheating	U	U	N	U	U	22f
8.8.2.11	Flameless combustion	U	N	N	U	N	22g
8.8.2.12	Oxy-fuel combustion	U	N	N	U	N	22h
8.8.2.13	Selective catalytic reduction (SCR)	U	U	N	N	N	22i, 29e
8.8.2.14	Selective non-catalytic reduction (SNCR)	U	N	N	N	N	22j
8.8.3.1	Closed degreasing tanks combined with air extraction in the case of continuous degreasing	N	U	N	U	N	23a

8.8.4.1	Batch pickling in tanks equipped with lids or enclosing hoods combined with fume extraction	U	U	U	U	N	24b, 25d
8.8.4.2	Continuous pickling in closed tanks combined with fume extraction	U	U	U	U	N	24a, 25c
8.8.4.3	Wet scrubbing followed by a demister	U	U	U	U	N	24c, 29d, 62c
8.8.5.1	Nitric-acid-free pickling of high-alloy steel	U	U	N	N	N	25a
8.8.5.2	Addition of hydrogen peroxide or urea to the pickling acid	U	U	U	N	N	25b
8.8.5.3	Wet scrubbing with addition of an oxidising agent (e.g. hydrogen peroxide)	U	U	U	N	N	25e
8.8.5.4	Selective catalytic reduction (SCR) in mixed acid pickling	N	U	N	N	N	25f
8.8.6.1	Low-fume flux	N	N	N	N	U	26a
8.8.6.2	Minimisation of carry-over of the fluxing solution	N	N	N	N	U	26b
8.8.6.3	Air extraction as close as possible to the source	N	N	N	U	U	26c
8.8.6.4	Enclosed kettles combined with air extraction	N	N	N	U	U	26d
8.8.7.1	Electrostatic oiling	N	U	N	U	N	27a
8.8.7.3	Contact lubrication	N	U	N	N	N	27b
8.8.7.4	Oiling without compressed air	N	U	N	N	N	27c
8.8.8.1	Use of a fuel or a combination of fuels with low sulphur and/or nitrogen content – Acid recovery	N	U	N	N	N	29a
8.8.8.3	Combustion optimisation – Acid recovery	N	U	N	N	N	29b
8.8.8.4	Low-NO _x burners – Acid recovery	N	U	N	N	N	29c
8.8.8.5	Wet scrubbing followed by a demister – Acid recovery	N	U	N	N	N	29d
8.9.1	Adsorption	U	N	N	N	N	31d
8.9.2	Aerobic treatment	U	U	N	N	N	31h

8.9.3	Chemical precipitation	U	U	U	U	N	31e
8.9.4	Chemical reduction	U	U	N	U	N	31f
8.9.5	Coagulation and flocculation	U	U	U	U	N	31i
8.9.6	Equalisation	U	U	U	U	N	31a
8.9.7	Filtration	U	U	U	U	N	31k
8.9.8	Flotation	U	U	U	U	N	31l
8.9.9	Nanofiltration	U	N	N	N	N	31g
8.9.10	Neutralisation	U	U	U	U	N	31b
8.9.11	Physical separation	U	U	U	U	N	31c
8.9.12	Reverse osmosis	U	N	N	N	N	31g
8.9.13	Sedimentation	U	U	U	U	N	31j
8.9.14	Treatment of water contaminated with oil or grease	U	U	U	U	N	30
8.10.1	Noise and vibration management plan	U	U	U	U	U	32
8.10.2	Appropriate location of equipment and buildings	U	U	U	U	U	33a
8.10.3	Operational measures	U	U	U	U	U	33b
8.10.4	Low-noise equipment	U	U	U	U	U	33c
8.10.5	Noise and vibration control equipment	U	U	U	U	U	33d
8.10.6	Noise abatement	U	U	U	U	U	33e
8.11.1.1	Residues management plan	U	U	U	U	U	34a
8.11.1.2	Pretreatment of oily scale for further use	U	N	N	N	N	34b
8.11.1.3	Use of mill scale	U	N	U	N	N	34c
8.11.1.4	Use of metallic scrap	U	U	U	U	N	34d
8.11.1.5	Recycling of metal and metal oxides from dry waste gas cleaning	U	N	N	N	N	34e
8.11.1.6	Use of oily sludge	U	U	N	N	N	34f
8.11.1.7	Thermal treatment of hydroxide sludge from the recovery of mixed acid	N	U	N	N	N	34g
8.11.2.1	Recycling of fabric filter dust	N	N	N	U	U	35a
8.11.2.2	Recycling of zinc ash and top dross	N	N	N	U	U	35b
8.11.2.3	Recycling of bottom dross	N	N	N	U	U	35c

Chapter 11

8.11.2.4	Environmental risk prevention from the storage of zinc-containing residues	N	N	N	U	U	36
8.11.3.1	Environmental risk prevention from the storage of lead-containing residues	N	N	U	N	N	55
8.11.3.2	Recycling of lead-containing residues from wire drawing	N	N	U	N	N	54
NB: U: Reported to be used at the time of writing; N: Reported as not used at the time of writing; NI: No information.							

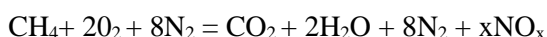
11.5 Combustion process(es) when using oxygen-enriched air or pure oxygen: normalisation based on the carbon dioxide generated during the combustion

This annex provides an example of how emission concentrations can be recalculated in combustion processes where (i) combustion air is enriched with oxygen (mixed air and oxy-fuel combustion) or (ii) combustion takes place with pure oxygen (oxy-fuel combustion).

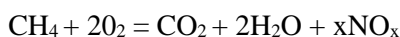
In combustion processes, combustion may take place using air, pure oxygen (oxy-fuel combustion) or a mixture of air and pure oxygen (partial oxy-fuel combustion). Equations describing the generation of NO_x in the different type of combustion processes are provided below:

In the following three cases, it is assumed that the O₂ concentration in dry-flue gases is the same (in this case %O₂=0 and x<<1).

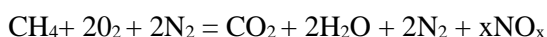
- Case 1 (air combustion): Using fuel (fuel as CH₄) and air



- Case 2 (oxy-fuel combustion): Using fuel (e.g. CH₄) and pure oxygen



- Case 3 (partial oxy-fuel combustion): Using fuel (e.g. CH₄), oxygen and air



The specific NO_x emission concentrations will vary significantly between the three type of combustion processes because of differences in the nitrogen content in the flue gas in each case. However, the relation between x (moles of NO_x generated) and the number of mole of CO₂ is the same in each of the three scenarios above. Therefore, a recalculation can be made by using the measured CO₂ concentration and the reference CO₂ concentration corresponding to the percent CO₂ in the flue gases as if air was used and the oxygen content in the flue gases was 3%.

The standard recalculation presented below which is normally used to recalculate emission concentrations to a standard reference oxygen level assumes that all the O₂ measured in the flue gas is coming from either air, burner surplus air or from the leakage of ambient air into the furnace and the flue gas system.

$$E_R = \frac{21 - O_R}{21 - O_M} \times E_M$$

where: E_R: emission concentration at the reference oxygen level O_R;
 O_R: reference oxygen level in vol-%;
 E_M: measured emission concentration;
 O_M: measured oxygen level in vol-%.

However, since the measured O₂ content in oxy-fuel combustion (total or partial) may originate either from air or from industrial grade pure O₂, the standard calculation above does not work anymore. Indeed, in oxy-fuel combustion, the effective dilutant of the theoretical stoichiometric flue gases is not containing 20,9 % O₂ and 79 % N₂. Thus, the above formula is not valid anymore. Alternatively, a normalisation can be made on the basis of the carbon dioxide generated by the combustion by applying the following formula:

$$E_R = \frac{CO_{2R}}{CO_{2M}} \times E_M$$

where:

- E_R : emission concentration at the reference oxygen level O_R as if ambient air was used;
- CO_{2R} : CO_2 level at the reference oxygen level as if ambient air was used in vol-% and is fuel specific;
- E_M : measured emission concentration;
- CO_{2M} : measured CO_2 level in vol-%.

Below, a practical example showing how this formula can be used is provided.

For this specific example, the following conditions are used:

- $O_R = 3\%$ O_2 in dry flue gases;
- $CO_{2M} = 11\%$;
- $E_M = 100$ ppm;
- Density $NO_2 = 2.053$ kg/Nm³;
- Fuel used = CH_4 .

First, the CO_{2R} at 3% O_2 is determined using the stoichiometric equation below:

$CH_4 + 1.15 (2O_2 + 7.57 N_2) = CO_2 + 2H_2O + 8.7N_2 + 0.3O_2$ (Total 12 Nm³ wet // 10 Nm³ dry flue gas)

$CO_{2R} = 10\%$

Once the CO_{2R} value is obtained, it is possible to normalise NO_x emission concentrations on the basis of the carbon dioxide generated by the combustion by applying the equations below:

$$E_R = \frac{CO_{2R}}{CO_{2M}} \times E_M$$

$$E_R = \frac{10}{11} \times (100 \times 2.053) = 186.6 \text{ ppm}$$

11.6 Examples of calculation of specific energy consumption for reheating, intermediate heating and post-heating processes in hot rolling

Introduction

This annex provides some examples to describe how the specific energy consumption for feedstock heating (i.e. reheating, intermediate heating, post-heating) in hot rolling has been calculated using the results of the data collection in this BREF. Calculations were made in accordance with the definition of the specific energy consumption in the general considerations of the BAT conclusions (see Section 9.4.4.1 and Section 9.5.4 in Chapter 9) using the following equation:

$$\text{Specific energy consumption} = \frac{\text{Energy consumption}}{\text{input}}$$

where:

energy consumption: total amount of heat (generated from primary energy sources) and electricity consumed by the relevant process(es), expressed in MJ/year or kWh/year; and

input: total amount of feedstock processed, expressed in t/year.

In the case of feedstock heating, the energy consumption corresponds to the total amount of heat (generated from primary energy sources) and electricity consumed by all furnaces in the relevant process(es).

Examples of calculation

An example plant (Plant A) consisting of two lines is used for the calculations. It is important to note that this plant is not part of the data collection, it is simply used for illustration using virtual data.

The configuration of the two lines for Plant A are as follows:

- Line (1) consists of a reheating section with only one furnace and a post-heating section with four distinct furnaces;
- Line (2) consists of a reheating section including a preheating furnace and two reheating furnaces and an intermediate reheating section with only one furnace.

The configurations of the two lines were chosen with a certain level of complexity (e.g. several furnaces, preheating furnace) to illustrate the calculations made for the specific energy consumption. Of course, more configurations are possible, but the examples below can serve as a guide to calculate the specific energy consumption for other possible configurations.

1. Line (1): Specific energy consumption for the reheating section with only one furnace (without a preheating furnace)

The energy consumption and total input to the reheating furnace are provided in the table below.

Furnace 1: Input = 300 000 t/y	
Primary energy sources	Energy consumption (GJ/y)
Natural gas	451 921.29
Coke oven gas	-
Blast furnace gas	119 453.39
BOF gas	-
Oil	-
LPG	-
Electricity	10 721

Based on the data above, the specific energy consumption for line 1 (reheating section) is calculated as follows:

$$\text{Specific energy consumption of reheating for Line 1} = \frac{(451\,924.29 + 119\,453.39 + 10\,721)(\text{GJ/y})}{300\,000 (\text{t/y})} \times 1\,000$$

$$= 1\,940 \text{ MJ/t}$$

2. Line (1): Specific energy consumption for the post-heating section comprising four furnaces

The energy consumption and total input for each of the post-heating furnaces in line (1) are provided in the table below.

Primary energy sources	Furnace 1: Input = 77 925 t/y	Furnace 2: Input = 33 000 t/y	Furnace 3: Input = 25 000 t/y	Furnace 4: Input = 55 000 t/y
	Energy consumption (GJ/y)	Energy consumption (GJ/y)	Energy consumption (GJ/y)	Energy consumption (GJ/y)
Natural gas	17 598	-	52 446	94 758
Coke oven gas	-	-	-	-
Blast furnace gas	-	-	-	-
BOF gas	-	-	-	-
Oil	-	-	-	-
LPG	-	-	-	-
Electricity	-	49 015	4 455	-

Based on the data above, the specific energy consumption for line 1 (post-heating section) is calculated as follows:

$$\text{Specific energy consumption of post - heating for Line 1} = \frac{(17\,598 + 49\,105 + 52\,446 + 4\,455 + 94\,758)(\text{GJ/y})}{(77\,925 + 33\,000 + 25\,000 + 55\,000) (\text{t/y})} \times 1\,000$$

$$= 1\,143.3 \text{ MJ/t}$$

3. Line (2): Specific energy consumption for the reheating section with one preheating furnace and two reheating furnaces

The energy consumption and total input for each of the furnaces in line (2) are provided in the table below.

Primary energy sources	Preheating furnace: Input = 230 489 t/y	Furnace 1: Input = 78 831 t/y	Furnace 2: Input = 486 851 t/y
	Energy consumption (GJ/y)	Energy consumption (GJ/y)	Energy consumption (GJ/y)
Natural gas	13 070	148 060	783 087
Coke oven gas	-	-	-
Blast furnace gas	-	-	-
BOF gas	-	-	-
Oil	-	-	-
LPG	-	-	-
Electricity	-	-	15 031

Based on the data above, the specific energy consumption for line 2 (reheating section) is calculated as follows:

$$\begin{aligned} \text{specific energy consumption of reheating for Line 2} \\ &= \frac{(13\,070 + 148\,060 + 783\,087 + 15\,031)(\text{GJ/y})}{(78\,831 + 486\,851)(\text{t/y})} \times 1\,000 \\ &= 1\,695.4 \text{ MJ/t} \end{aligned}$$

Note: In the case of a preheating furnace, the energy consumption of the preheating furnace is considered in the numerator, but the input to the preheating furnace is not taken into account in the denominator, in order to avoid counting the feedstock twice.

4. Line (2): Specific energy consumption for the intermediate section with only one furnace

The energy consumption and total input for the intermediate reheating furnace in line (2) is provided in the table below.

Primary energy sources	Furnace 1: Input = 201 332 t/y
	Energy consumption (GJ/y)
Natural gas	-
Coke oven gas	-
Blast furnace gas	-
BOF gas	-
Oil	-
LPG	-
Electricity	25 520

Based on the data above, the specific energy consumption for line 2 (intermediate reheating section) is calculated as follows:

$$\begin{aligned} \text{specific energy consumption of intermediate heating for Line 2} &= \frac{25\,520(\text{GJ/y})}{201\,332(\text{t/y})} \times 1\,000 \\ &= 126.75 \text{ MJ/t} \end{aligned}$$

Conversion factors

When the values of the primary energy sources are expressed in volume flow (Nm³/y) or power supply for electricity (MWh/y), the net calorific values were used to convert the energy consumption values into GJ/y. The net calorific values used for conversion are summarised in the table below.

Primary energy sources	Net calorific values
Natural gas	36.80 MJ/Nm ³
Coke oven gas	19.00 MJ/Nm ³
Blast furnace gas	3.30 MJ/Nm ³
BOF gas	9.00 MJ/Nm ³
Oil	40.00 GJ/t
LPG	46.00 GJ/t
Electricity (*)	3.60 GJ/MWh
Note (*): For electricity, the power equivalent is used instead of net calorific values.	

11.7 Example of calculation of the average yearly production throughput in batch galvanising

Introduction

This annex provides some examples to describe how the average yearly production throughput of batch galvanising kettles, expressed in t/m^3 , is calculated. This concept is used in footnote (2) of Table 9.4 in the BAT conclusions (see Section 9.5.4).

Example of calculation

The table below shows data for the batch galvanising plant W (virtual plant not included in the data collection) concerning the volume of the hot dipping bath (in m^3), and the total yearly production of galvanised items in 2014, 2015 and 2016. The yearly production throughput is calculated by dividing (for each year) the production of galvanised items by the volume of the hot dipping bath.

Plant	Volume bath (m^3)	Production 2014 (t)	Production 2015 (t)	Production 2016 (t)	2014 yearly production throughput (t/m^3)	2015 yearly production throughput (t/m^3)	2016 yearly production throughput (t/m^3)
W	90	31 281	33 896	34 617	348	377	385

The second example presented in the table below considers a batch galvanising plant X (virtual plant not included in the data collection) with two lines, each comprising one hot dipping bath. In that case, the yearly production throughput is calculated as follows:

Plant X	Volume bath (m^3)	Production 2014 (t)	Production 2015 (t)	Production 2016 (t)
Line 1	38.5	43 090.23	46 407.12	34 594.27
Line 2	14.8	549.90	348.89	526.82

$$\begin{aligned} \text{Yearly production throughput of galvanised items in 2014} &= \frac{(43\,090.23 + 549.90)(t)}{(38.5 + 14.8) (m^3)} \\ &= 818.76 \text{ t/m}^3 \end{aligned}$$

$$\begin{aligned} \text{Yearly production throughput of galvanised items in 2015} &= \frac{(46\,407.12 + 348.89)(t)}{(38.5 + 14.8) (m^3)} \\ &= 877.22 \text{ t/m}^3 \end{aligned}$$

$$\begin{aligned} \text{Yearly production throughput of galvanised items in 2016} &= \frac{(34\,594.27 + 526.82)(t)}{(38.5 + 14.8) (m^3)} \\ &= 658.93 \text{ t/m}^3 \end{aligned}$$

11.8 Examples of calculation of specific material consumption

Introduction

This annex provides examples to describe how the average over 3 years of the specific material consumption has been calculated using the results of the data collection in this BREF. Calculations were made in accordance with the definition of the specific material consumption in the general considerations of the BAT conclusions (see Sections 9.4.4.3 and Section 9.5.5 in Chapter 9) using the following equation:

$$\text{Specific material consumption} = \frac{\text{material consumption}}{\text{input}}$$

where:

material consumption: 3-year average of total amount of material consumed by the relevant process(es), expressed in kg/year; and

input: 3-year average of total amount of feedstock processed, expressed in t/year or m²/year.

Examples of calculation

The table below summarises the material consumption data for an example plant (virtual plant not included in the data collection) over 3 years (between 2021 and 2024).

Year	Material consumption (kg/y)	Input (t/y)	Specific material consumption (kg/t)
2019	230	15	-
2020	250	17	-
2021	220	14	15.22
2022	235	15	15.33
2023	230	16	15.22
2024	-	15	10.11

Based on the data above, the specific material consumption for the years 2021, 2022, 2023 and 2024 can be calculated as follows:

$$\text{average over 3 years for specific material consumption (year 2021)} = \frac{230+250+220(\text{kg/y})}{15+17+14(\text{t/y})} = 15.22 \text{ kg/t}$$

$$\text{average over 3 years for specific material consumption (year 2022)} = \frac{250+220+235(\text{kg/y})}{17+14+15(\text{t/y})} = 15.33 \text{ kg/t}$$

$$\text{average over 3 years for specific material consumption (year 2023)} = \frac{220+235+230(\text{kg/y})}{14+15+16(\text{t/y})} = 15.22 \text{ kg/t}$$

$$\begin{aligned} \text{average over 3 years for specific material consumption (year 2024)} &= \frac{235 + 230(\text{kg/y})}{15 + 16 + 15(\text{t/y})} \\ &= 10.11 \text{ kg/t} \end{aligned}$$

Note: When for a specific year, there is no consumption reported for this year (e.g. the year 2024), the material consumption for this year is not included in the equation, but the input is taken into account and included in the denominator.

11.9 Comparison of NO_x reduction methods for furnaces

Technique	Advantages	Disadvantages
Low-NO_x burners	<ul style="list-style-type: none"> - Moderate to high level of NO_x reduction - Fuel consumption unchanged - Low or zero increase in operating cost penalty - Improved furnace temperature uniformity - Combustion system not downrated 	<ul style="list-style-type: none"> - Capital cost - Longer flame - Different flame shape than existing - Change in flame velocity - Reduced flame stability – safety risk at temperatures below self-ignition
Limiting air preheat	<ul style="list-style-type: none"> - Can be simple, with low or zero capital cost - Moderate to high level of NO_x reduction 	<ul style="list-style-type: none"> - Increased fuel consumption - Downrating of combustion equipment - Reduced flame stability - Reduced burner velocity therefore furnace temperature uniformity
Flue-gas recirculation	<ul style="list-style-type: none"> - Moderate to high level of NO_x reduction - Improved temperature uniformity - Medium capital costs (if no uprating required) 	<ul style="list-style-type: none"> - Capital cost (if uprating required) - Increased energy consumption - More space required (especially if uprating required) - Reduced flame stability - Existing combustion system might be downrated
SCR	<ul style="list-style-type: none"> - High level of NO_x removal - Combustion system not downrated 	<ul style="list-style-type: none"> - High capital costs - Increased energy consumption and operating costs - Ammonia slip - Ammonia storage required - Sensitive to changes in temperature/flowrates - Requires specific waste gas temperature - Less effective when the NO_x concentration is low
SNCR	<ul style="list-style-type: none"> - Moderate to high level of NO_x reduction - Combustion system not downrated 	<ul style="list-style-type: none"> - Capital cost - Increased energy consumption and operating costs - Ammonia slip - Ammonia storage required (unless urea is used) - Sensitive to changes in temperature/flowrates/stoichiometry - Requires specific furnace temperature - Less effective when the NO_x concentration is low
<p>Source [25, EUROFER 2018], [48, ETSU 1996]</p>		

GLOSSARY

This glossary is meant to facilitate the understanding of the information contained in this document. The definitions of terms in this glossary are not legal definitions (even if some of them may coincide with definitions given in European legislation), they are meant to help the reader understand some key terms in the context of their use in the specific sector covered by this document.

This glossary is divided up into the following sections:

- I. ISO country codes
- II. Monetary units
- III. Units and measures
- IV. Acronyms
- V. Abbreviations used in the graphs

I ISO country codes

ISO code	Member State
<i>Member States (*)</i>	
AT	Austria
BE	Belgium
BG	Bulgaria
HR	Croatia
CZ	Czech Republic
CY	Cyprus
DE	Germany
DK	Denmark
EE	Estonia
EL	Greece
ES	Spain
FI	Finland
FR	France
HU	Hungary
IE	Ireland
IT	Italy
LT	Lithuania
LU	Luxembourg
LV	Latvia
MT	Malta
NL	Netherlands
PL	Poland
PT	Portugal
RO	Romania
SE	Sweden
SI	Slovenia
SK	Slovakia
<i>Non-member countries</i>	
UK	United Kingdom
US	United States
(*) The protocol order of the countries is based on the alphabetical order of their geographical names in the original language(s).	

II. Monetary units

Code ⁽¹⁾	Country/territory	Currency
<i>Member State currencies</i>		
EUR	Euro area ⁽²⁾	euro (pl. euros)
SEK	Sweden	Swedish krona (pl. kronor)
<i>Other currencies</i>		
USD	United States	US dollar

⁽¹⁾ ISO 4217 codes.
⁽²⁾ Includes Austria, Belgium, Cyprus, Estonia, Finland, France, Germany, Greece, Ireland, Italy, Latvia, Lithuania, Luxembourg, Malta, the Netherlands, Portugal, Slovakia, Slovenia and Spain.

III. Unit and measurements

TERM	MEANING
atm	normal atmosphere (1 atm = 101325 N/m ²)
bar	bar (1.013 bar = 1 atm)
°C	degree Celsius
cm	centimetre
d	day
dB	Decibel. The unit of measuring noise emission levels
dB(A)	Noise is measured in decibels (dB). To address the way the human ear responds to sound of different frequencies (itches), an A-weighting is commonly applied, and the measurements are expressed in dB(A). Every 3 dB(A) reduction is equivalent to halving the noise emission level.
g	gram
GJ	gigajoule
Hz	hertz
h	hour
J	joule
K	kelvin (0 °C = 273.15 K)
kcal	kilocalorie (1 kcal = 4.19 kJ)
kg	kilogramme (1 kg = 1 000 g)
kJ	kilojoule (1 kJ = 0.24 kcal)
kPa	kilopascal
kt	kilotonne
kW	kilowatt
kWh	kilowatt-hour (1 kWh = 3600 kJ = 3.6 MJ = 0.0036 GJ)
l	litre
m	metre
m ²	square metre
m ³	cubic metre
mg	milligram (1 mg = 10 ⁻³ gram)
MJ	megajoule (1 MJ = 1 000 kJ = 10 ⁶ joule)
MJ/t	megajoule per tonne
nm	nanometre (1 nm = 10 ⁻⁹ m)
mm	millimetre (1 mm = 10 ⁻³ m)
m/min	metres per minute
Mt	megatonne (1 Mt = 10 ⁶ tonne)
Mt/yr	megatonnes per year
MW _{th}	megawatts thermal (energy)
ng	nanogram (1 ng = 10 ⁻⁹ gram)
Nm ³	normal cubic metre (101.325 kPa, 273 K)
ppm	parts per million (by weight)
s	second
t	metric tonne (1 000 kg or 10 ⁶ gram)
t/d	tonnes per day
t/yr	tonne(s) per year
vol-%	percentage by volume
W	watt (1 W = 1 J/s)
wt-%	percentage by weight
yr	Year
~	around; more or less
µm	micrometre (1 µm = 10 ⁻⁶ m)

IV. Acronyms

BAT	Best Available Technique(s), as defined in Article 3(10) of the IED
BAT-AEL	Best Available Techniques - associated emission level, as defined in Article 3(13) of the IED
BAT-AEPL	Best Available Techniques - associated performance emission level, as described in Section 3.3.2 of Commission Implementing Decision 2012/119/EU
BFG	Blast furnace gas
BG	Batch galvanising
BOF	Basic oxygen furnace gas
BREF	Best available techniques (BAT) reference document
CEN	The European Committee for Standardisation
CHP	Cogeneration of heat and power (combined heat and power)
CLM BREF	BAT Reference Document for for the Production of Cement, Lime and Magnesium Oxide
COD	Chemical oxygen demand
COG	Coke oven gas
CR	Cold rolling
CWW BREF	BAT Reference Document in the Common Waste Water and Waste Gas Treatment/Management Systems in the Chemical Sector
EC	European Commission
EWC	European Waste Catalogue, established by Commission Decision 2000/532/EC
EFS BREF	BAT Reference Document on Emissions from Storage
EIPPCB	European IPPC Bureau
EMAS	Eco-Management and Audit Scheme
EMS	Environmental management system
EN	European Norming (EN standards)
EP	Electrostatic precipitator
ENE BREF	BAT Reference Document for Energy Efficiency
ESP	Electrostatic precipitator
EU	European Union
FMP	Ferrous metals processing
HSLA	High Strength Low Alloy
ISO	International Organisation for Standardisation
IPPC	Integrated pollution prevention and control
LCP BREF	BAT Reference Document for Large Combustion Plants
LPG	Liquefied petroleum gas
MS	Member State(s) of the European Union
NGO	Non-governmental organisation
NO _x	Nitrous oxides
OTNOC	Other than normal operating conditions
PAH	Polyaromatic hydrocarbon
PM	Particulate matter
SCR	Selective catalytic reduction
SNCR	Selective non-catalytic reduction
SO _x	Sulphur oxides
TN	Total nitrogen
TOC	Total organic carbon
TP	Total phosphorus
TSS	Total suspended solids
TVOC	Total volatile organic carbon, expressed as C (in air)
TWG	Technical working group
UV	Ultraviolet
VOC	Volatile organic compound
WD	Wire drawing
WT BREF	BAT Reference Document for Waste Treatment
WWTP	Waste water treatment plant

V. Abbreviations

Abbreviations used in the figures of emissions to air

Abbreviations used to express the concentrations and number of measurements

Sector	Abbreviations / Term used	Information
HR, CR plants	Max. for year 1/2016	Maximum value of all reported measurements for year 2016 or the first year of reporting data
	Max. for year 2/2015	Maximum value of all reported measurements for year 2015 or the second year of reporting data
	Max. for year 3/2014	Maximum value of all reported measurements for year 2014 or the third year of reporting data
	Average for 3 years	The average value of all reported measurements for the three reporting years (either the period 2014-2016, or the last three years with available data).
	Number of measurements	The number of measurements over the three reporting years. For continuous monitoring, the letter 'C' is denoted.
WD, HDC, BG	Pollutant (unit), MxYx e.g. Dust (mg/Nm ³) M1Y1	Name of the pollutant, measurement unit, number of measurement and year of three reporting years
All sectors	CO at max. NO _x value	CO concentration corresponding to the maximum NO _x value over the reporting period
	Reference O ₂ level (%)	O ₂ reference value at the maximum concentration of the parameter plotted in the graph
	% Ref O ₂ (max)	
	O ₂ reported (%)	O ₂ value as reported at the maximum concentration of the parameter plotted in the graph
	O ₂ (%) (parameter) e.g. O ₂ (%) NO _x	

Abbreviations used for monitoring frequency

Abbreviations	Monitoring frequency
C	Continuous
4/y	4 times per year
3/y	3 times per year
2/y	2 times per year
1/y	Once per year
2y	Every 2 years
3y	Every 3 years
5y	Every 5 years

Abbreviations used for fuels

Abbreviations	Fuel
NG	Natural gas
COG	Coke oven gas
BFG	Blast furnace gas
BOF	Basic oxygen furnace gas
LPG	Liquefied petroleum gas

Abbreviations used for the type of product

Abbreviations	Type of product
bi	Billets
ra	Rails
ro	Rods/Wire Rods
ba	Bars
tu	Tubes
st	Strips (hot rolled coils)
pl	Plates
be	Beams
ot	Other profiles
ri	Rings

Abbreviations used for the steel grade in hot rolling figures

Abbreviations	Steel categories
CS-EI	CS-Electrical steel Grain-Oriented
CS-O	CS-Other (non-alloy/low-alloy)
SS-F	SS-Ferritic
SS-A	SS-Austenitic
SS-M	SS-Martensitic
SS-D	SS-Duplex (mixed ferritic and austenitic)
O-HA	Other high-alloy steels
CS	CS-not specified, otherwise with CS>90%
M	Mix of products with 10%<CS<90%
SS	SS-not specified, otherwise with SS>90%
CS-CR	CS-Cold rolled products automotive
CS-OA	CS-Cold rolled products others than automotive
CS-P	CS-Products for packaging

Abbreviations used for the steel grade in cold rolling figures

Abbreviations	Steel categories
CS-P	CS-Products for packaging
CS-GO	CS-Electrical steel Grain Oriented
CS-GO	CS-Electrical steel Grain Oriented (GO)
CS-NO	CS-Electrical steel Non Oriented (NONO)
CS-HS	CS-High strength steels with yield strength $Re > 420$ MPa, mainly used for automotive
CS-MH	CS-Medium and high carbon steels ($C > 0.3\%$)
CS-O	CS-Other (non alloy/low alloy)
SS-F	SS-Ferritic
SS-A	SS-Austenitic
SS-M	SS-Martensitic
SS-D	SS-Duplex (mixed ferritic and austenitic)
O-HA	Other high alloy steels

Abbreviations used for steel grade in hot dip coating figures

Abbreviations	Steel categories
CS-CR	CS-Cold rolled products automotive
CS-OA	CS-Cold rolled products others than automotive

Abbreviations used for hot rolling furnace types

Abbreviations	Furnace type
Batch	Batch furnace
Push	Pushing furnace
Roll hth	Roller hearth furnace
Rot hth	Rotary hearth furnace
Tunn	Tunnel furnace
Walk	Walking beam furnace

Abbreviations used in the techniques for hot rolling figures

Abbreviation	Equipment contributing to emissions
Regen	Regeneration
Dry ESP	Dry electrostatic precipitator
Wet ESP	Wet electrostatic precipitator
Acid gas Abate	Acid gas Abatement
Encl Grind WGC	Enclosed Grinding Operation with Waste Gas Cleaning
External FGR	External Flue-Gas Recirculation (FGR)
Oscil comb for low NO _x	Oscillating combustion for NO _x emission reduction
Sequent Impulse Firing	Sequential impulse firing burner technology for reheating furnaces

Abbreviations for type of pickling line

Abbreviations	Pickling line type
pul psh	push pull
cont.	continuous pickling
batch	batch pickling

Abbreviations used for the type of acid regeneration systems

Abbreviations	Acid regeneration systems
Flu Bed	Fluidized bed regeneration
Spray Roast	Spray roasting regeneration
Cryst	Crystallization recovery
Ion Exch	Ion exchange recovery
Diff Dial	Diffusion dialysis recovery
Evap	Evaporation recovery
Neutr	Neutralization
Retard	Retardation
El Oxid	Electrolytic oxidation
El Fe Precip	Electrolytic Fe precipitation
Chem Oxid	Chemical oxidation
Precip Solv	Precipitation with solvents

Abbreviations used for the type of tanks in pickling figures

Abbreviations	Type of tanks
deep	deep-type tanks
shall	shallow-type tanks
turb	turbulence tanks
trbfl	turboflow tanks

Abbreviations used for lubrication and oiling type

Abbreviations	Type rolling lubrication/oiling type
Dir App	direct application
Em Rec	emulsion recirculation
Pur Oil Rec	pure oil recirculation
E static	Electrostatic
Spray	Spray oiling
Rolls	Oiling rolls
Other	Other
None	None

Abbreviations used in the techniques for cold rolling figures

Abbreviation	Equipment contributing to emissions
Decoiler D Red	Reduction of Dust Emission at the Decoilers
Pickl Emission Control/collection	Emission Control/Collection from Pickling
Wet ESP	Wet electrostatic precipitator
Regen/Recup burners	Preheating Combustion Air/Use of Regenerative or Recuperative Burners for Annealing Furnace
Acid gas Abate	Acid gas Abatement
External FGR	External Flue-Gas Recirculation (FGR)
Closed Tank EGS	Reduction of Emissions from Pickling/Closed HCl and H ₂ SO ₄ Pickling Tanks with Exhaust Gas Scrubbing
Closed Mix Acid EGS	Reduction of Emissions from Pickling/Closed Mixed Acid Pickling Tanks with Exhaust Gas Scrubbing
Oil Mist Abate	Capture and Abatement of Oil Mists from Oiling Operation
Oil Mist Separation	Extraction of Oil Mist Emissions and Oil Separation
Oil Mist & Dust Red	Reduction of Oil Mist and Dust

Abbreviations used for the type of descaling in wire drawing figures

Abbreviations	Type of descaling
Chem	Chemical (Pickling)
Mech	Mechanical

Abbreviations used for the processes hot dip coating figures

Abbreviations	Process
SC-Heat	Sheet Coating - Heat treatment before dipping
SC-Galva	Sheet Coating - Galvannealing
WC-Kettle	Wire Coating - Kettle heating

Abbreviations used for the equipment contributing to emissions in hot dip coating figures

Abbreviation	Equipment contributing to emissions
Ann f	Annealing furnace
Preh. Sec	Preheating section
HTF	Heat treatment furnace
All zones	Combined emission from all zones
Ann. Sec	Annealing section
HTbd	Heat treatment before dipping
F	Furnace (vent called four coté Meuse)
Galv f	Galvannealing furnace
Preh. F/NOF	Pre Heating Furnace / Non Oxidising Furnace
RTF	Radiant Tube Furnace
Preh. FDF	Pre Heating furnace Direct Flame

Abbreviations used in the figures of emissions to water

Abbreviations used for origin of streams

Abbreviations	Origin of stream
NT	The waste water is not treated in the FMP plant before entering the common WWTP (where N is repeated, additional non-treated streams enter the plant)
T	The waste water is pretreated in the FMP plant before entering the common WWTP (where T is repeated, additional treated streams enter the plant)
WWP	Waste water plant
HDC	Hot dip coating
WD	Wire drawing
CR	Cold rolling
HR	Hot rolling

REFERENCES

- [1] EUROFER, 'Personal communication from EUROFER (A. Thuau / 21/05/2021)', Personal communication, 2021.
- [2] EUROFER, 'Global steel tube market Personal communication from EUROFER (A. Thuau / 16/11/2021)', Personal communication, 2021.
- [3] EUROFER, *EUROFER comments on revised FMP BREF D1, October, 2020.*
- [4] EUROFER, *EUROFER, Task Group Hot Rolling, Technical note on the BAT to the Integrated Pollution Prevention and Control. Draft: Hot Rolling Mill, 1998.*
- [5] Ullmann's, *Ullmann's Encyclopedia of Industrial Chemistry, 5. edition Steel*, VCH Verlagsgesellschaft, Weinheim, 1994.
- [6] EUROFER, *Technical input from EUROFER on HR related to: 1) Applied processes and techniques, 2) Present consumption and emissions levels*, Industry association – EUROFER, 2019.
- [7] COM, *Panorama of EU Industry*, 1997.
- [8] Deutscher Verlag für Grundstoffindustrie-Leipzig, *Vortrag anlässlich der Mitgliederversammlung des Industrieverbands Feuerverzinken am 1997*, 1990.
- [9] ETSU - c, *Dual-Fuel Regenerative Burners on a Large Re-Heating Furnace*, Energy Technology Support Unit (ETSU), 1993.
- [10] Rentz et al., *BAT in the German Ferrous Metals Rolling Industry (Chapters 1-3)*, DFIU, pp. Chapters 1-3, 1998.
- [11] ETSU - b, *Continuous Steel Reheating Furnaces: Operation and Maintenance*, Energy Technology Support Unit (ETSU), 1993.
- [12] SE TWG, *FMP applied processes descriptions: Hot ring rolling and Cold pilgering*, 2019.
- [13] Zur et al., 'Anwendung von Zweistoff-Filtern zur Kreislauf-Wasserbehandlung in einem Warmbreitbandwalzwerk', *Stahl und Eisen* Vol. 96 No 7, 1976.
- [14] Hot Rolling Shadow Group, 'Comments on 2nd draft FMP from Hot Rolling Shadow Group', Personal communication, 2000.
- [15] UK, TWG member, 'Comments on 1st draft FMP from UK', Personal communication, 1999.
- [16] FMP TWG, *FMP data collection 2018*, 2018.
- [17] Davy Consultants, *Pollution Control for Casting and Shaping Iron and Steel, Ferrous and Special Alloys*, Department of the Environment HMIP Commissioned Research, 1993.
- [18] CITEPA, *Technical Note on BAT to reduce emissions of pollutants into the air from hot and cold rolling mills in iron and steel industry*, 1994.
- [19] Roederer et al., *Coordinated study "Steel-Environment"*, 1996.
- [20] IT, 30-05-2019, 'Correlation between NOx emission concentrations and temperature of preheated combustion air', Personal communication, 2019.
- [21] EUROFER, *EUROFER comments to the key topics listed for FMP 2nd data workshop*, EUROFER, 2019.
- [22] COM, *Best Available Techniques (BAT) Reference Document for Iron and Steel Production (IS BREF)*, European Commission, JRC IPTS EIPPCB, 2013.
- [23] Lecomte et al., *Best Available Techniques (BAT) Reference Document for Large Combustion Plants (LCP BREF)*, European Commission - Joint Research Centre, 2017.
- [24] TWG, *FMP TWG comments on D1*, 2019.

- [25] EUROFER, *EUROFER contribution to Draft 1 - Proposal for Revised BAT candidates (23-7-18)*, 2018.
- [26] Hot Rolling Shadow Group, 'Comments on 1st draft FMP from Hot Rolling Shadow Group', Personal communication, 1999.
- [27] Van Roosbroeck, 'Input-HR-1', Personal communication, 1999.
- [28] AT, TWG member, 'Comments on 1st draft FMP from Austria', Personal communication, 1999.
- [29] EUROFER, 'EUROFER follow-up input to decisions agreed in web-based meetings (Submitted 18/03/2021)', Personal communication, 2021.
- [30] AT 31-5-17, *Austria contribution to Draft 1 - Proposal for Revised BAT candidates*, 2017.
- [31] EUROFER 10-7-18, *Eurofer contribution to Draft 1 - Proposal for Revised BAT candidates*, 2018.
- [32] Pre-FD comments, 'Comments received on the FMP BREF pre-final draft (08/09/2021)', Personal communication, 2021.
- [33] Niemela et al., 'Formation, characteristics and utilisation of CO-rich gas formed in ferrochromium smelting', 2004.
- [34] COM, *Best Available Techniques (BAT) Reference Document for the Non-ferrous Metals Industries (NFM BREF)*, European Commission, JRC Seville EIPPCB, 2017.
- [35] Münch, 'Leistungssteigerung und Einsparung von Wärmeenergie bei der Warmbandherstellung', *Stahl und Eisen* Vol. 117 No 5, 1997.
- [36] Lindfors et al., *BAT examples fom the Nordic iron and steel industry*, pp. 132 – 134, 2006.
- [37] ETSU, *Continuous Steel Reheating Furnaces: Specification, Design and Equipment*, Energy Technology Support Unit (ETSU), 1993.
- [38] Schéele, 'Oxyfuel Combustion in the Steel Industry: Energy Efficiency and Decrease of CO₂ Emissions', *In the book: Energy Efficiency, Jenny Palm (Ed.), ISBN: 978-953-307-137-4*, pp. 84 – 102, 2010.
- [39] Niemi et al., 'Experiences from Oxygen Lancing in slab reheating', *The Finnish and Swedish National Committees Finnish – Swedish Flame Days 2013*, 2013.
- [40] EUROFER 31-3-17, *Eurofer contribution to Draft 1 - Proposal for Revised BAT candidates*, 2017.
- [41] EUROFER, 'Candidate techniques submitted 20-03-2020', Personal communication, 2020.
- [42] Lantz et al., '25 % Increased Reheating Throughput and 50 % Reduced Fuel Consumption by Flameless Oxyfuel at ArcelorMittal Shelby - Tubular Products, Ohio', *AISTech 2008 — The Iron and Steel Technology Conference and Exposition*, Pittsburgh, 2008.
- [43] Abuelnor et al., 'Characterisation of a low NOX flameless combustion burner using natural gas.', *Jurnal Teknologi (Sciences and Engineering)* Vol. 66:2, pp. 121-125, 2014.
- [44] Iron and Steel Today, 'Wide-ranging benefits of flameless oxyfuel combustion', *Iron and Steel Today - Heating and Combustion* Vol. June No July 2008, pp. 17 -18, 2008.
- [45] Curry, 'The basics of pulse firing.', *Industrial Heating* Vol. October 2011, 2011.
- [46] EUROFER, 'Personal communication EUROFER (31.3.99)', Personal communication, 1999.
- [47] EUROFER, 'Personal communication EUROFER (3.4.99)', Personal communication, 1999.

References

- [48] ETSU, *NO_x Reduction Technology for Steel Reheating and Heat Treatment Furnaces*, Energy Technology Support Unit (ETSU), 1996.
- [49] DK, TWG member, 'Personal communication DK (30.6.99)', Personal communication, 1999.
- [50] EUROFER, 'Personal communication EUROFER (2.7.99)', Personal communication, 1999.
- [51] Davies et al., *The Control of the Emissions of Oxides of Nitrogen from Certain Combustion Processes*, Inspectorate of Pollution, Department of the Environment, 1995.
- [52] Vercaemst, 'Personal communication Vercaemst (27.7.99)', Personal communication, 1999.
- [53] Oekopol, 'Personal communication Oekopol (7.9.99)', Personal communication, 1999.
- [54] EUROFER, 'Personal communication EUROFER (17.4.99)', Personal communication, 1999.
- [55] Kirk, *Hot charging practice for continuous steel reheating furnaces*, Energy Technology Support Unit ETSU - Good Practice Programme ETSU, 1995.
- [56] Hendricks et al., 'Energieaspekte und gegenwärtiger Verbrauch an Energierohstoffen der Weltstahlerzeugung', *Stahl und Eisen* Vol. 118 No 2, 1998.
- [57] Worrell et al., *Energy efficiency improvement and cost saving opportunities for the US Iron and Steel Industry - An Energy Star® guide for energy and plant managers*, Ernest Orlando Lawrence Berkeley National Laboratory, pp. 96-97, 2010.
- [58] Brimacombe et al., 'The challenges of thin slab casting (Near-Net-Shape)', *Near-Net-Shape Casting in the Minimills, Intentional Symposium, Metallurgical Society of the Canadian Institute of Mining*, 1996.
- [59] Albedyhl et al., 'Werkstoffliche Aspekte des Dünnbrammengießens', *Stahl und Eisen* Vol. 118 No 5, 1998.
- [60] www.algoma.com, *Direct Strip Production Complex (DSPC)*, 1998.
- [61] Kordzadeh, E., 'An introduction to the thin slab technologies', 2016.
- [62] EUROFER, *EUROFER input post 2nd FMP BREF data assessment workshop*, 2019.
- [63] Grobe et al., 'Einsatz von Optimierungsrechnern an den Erwärmungsanlagen eines Rohrwalzwerkes', *Stahl und Eisen* Vol. 116 No 11, 1996.
- [64] Hoedl et al., 'VAI beam-blank casting technology – Fundamentals and examples of plant installations', *Nota technical – La Metallurgia Italiana*, pp. 63-66, 2003.
- [65] Klose et al., 'De-oiling of millscale sludge by a wet-mechanical procedure', 2016.
- [66] Hnizdil et al., 'Experimental study of in-line treatment of 1.0577 structural steel.', *Procedia Manufacturing* Vol. 15, pp. 1596 – 1603, 2018.
- [67] Kotrbacek et al., 'Experimental study of heat transfer in hot rolling', *Revue de Metallurgie - Cahier d'informations techniques* Vol. 103 No 7, pp. 333-341, 2006.
- [68] Ammerling et al., 'Implementation of a new 3-roll reducing and sizing block in a wire rod and bar mill.', 2005.
- [69] Seki et al., *Making to High performance and productivity improvement of steel bar and wire rod rolling process*, pp. 21-28, 2007.
- [70] EUROFER 31-5-17, *Eurofer contribution to Draft 1 - Proposal for Revised BAT candidates*, 2017.
- [71] Fichtner, *Hessisches Vollzugs-programm zur durchführung des restoffvermeidungs- und -verwertungsgebotes nach 5-1-3 bimschg*, 1994.
- [72] Schwandtner, 'Abwasserbehandlung (Stand Mai 1990) Badische Stahlwerke Aktiengesellschaft', Personal communication, 1990.

- [73] Theobald, *Hintergrundpapier zum Anhang 24 (Anforderungen an die Eisen- und Stahlindustrie) zur Rahmen-Abwasserverordnung nach § 7a Wasserhaushaltsgesetz*, 1997.
- [74] Dammann et al., *Belüftete Feinzunderfäz zur Behandlung von Prozeß-wasser aus Stranggießanlagen und Warmwalzwerken*, 1994.
- [75] Batisch et al., *Investitionen zur Verminderung von Umweltbelastungen Programm des Bundesministers für Umwelt, Naturschutz und Reaktorsicherheit*, Klöckner Stahl GmbH, Bremen, 1996.
- [76] Wallin et al., *Novel Techniques for the reclamation of Water and Scale-products in Steel Mill Operations (Svedala)*, Svedala Industries, 1996.
- [77] Andersson, 'Pollution Prevention in the Hot Strip Mill (SSAB)', *European Symposium on Environmental Control in the Steel Industry*, International Iron and Steel Institute, 1995.
- [78] Dammann, *Anlagen nach dem Stand der Technik für die Prozeßwasserbehandlung in Warmwalzwerken und Stranggießanlagen*, 1994.
- [79] Lieber et al., *Altanlagenprogramm des Bundesministers des Innern Emissionsminderung durch Abgasfassung und Abgasreinigung in einem Stückverzinkungsbetrieb*, 1985.
- [80] DE, TWG member, 'Comments on 2nd draft FMP from Germany', Personal communication, 2000.
- [81] Haskoning, *Techno-economic Study on the Reduction Measures, Based on Best Available Technologies, of Water Discharges and Waste Generation from Primary and Secondary Iron & Steel Industry*, European Commission - Final report prepared by Haskoning NL-Nijmegen, 1993.
- [82] DE, TWG member, 'Comments on 1st draft FMP from Germany', Personal communication, 1999.
- [83] Foresti et al., 'Organic Rankine Cycle (ORC) waste heat recovery system at rolling mill reheating furnace', *11th European Electric Steelmaking Conference - 25th to 27th May*, Venice (Italy), 2016.
- [84] Menges et al., *Badische Stahlwerke GmbH - Environmental Declaration 2017*.
- [85] Wong, 'Organic Rankine Cycle (ORC) waste heat recovery system at rolling mill reheating furnace', *Technical presentation at the 2013 National Energy Efficiency Conference*, October 9-10 (2013), Singapore, 2013.
- [86] Campana et al., 'ORC waste heat recovery in European energy intensive industries: Energy and GHG savings.', *Energy Conversion and Management* Vol. 76, pp. 244-252, 2013.
- [87] PT, 'Personal communication from Ana Marcao (Portugal) on the electrical welding of billets technique using water spays and a spark killer device for suppression of fugitive dust emissions. (Submitted on the 04/01/2021)', Personal communication, 2021.
- [88] Beddows & Co., *The EU Cold Rolled Strip Industry*, 1995.
- [89] EUROFER, TG Cold Rolling, *Technical note on the BAT to the Integrated Pollution Prevention and Control. Draft: Cold Rolling Mill*, 1998.
- [90] VDMA, 'Comments on 1st draft FMP from VDMA', Personal communication, 1999.
- [91] EUROFER, *Technical input from EUROFER on CR related to: 1) Applied processes and techniques, 2) Present consumption and emissions levels*, Industry association – EUROFER, 2019.
- [92] EUROFER, 'Additional comments to NOx and air preheating in batch annealing', Personal communication, 2019.
- [93] Cold Rolling Shadow Group, 'Comments on 2nd draft FMP from Cold Rolling Shadow Group', Personal communication, 2000.

References

- [94] Strehlau, 'Introducing cold pilger mill technology. An overview of the equipment and the process. The tube & pipe journal', 2006.
- [95] AT, 'Notes on energy consumption in cold rolling and hot dip coating for advanced steel grades (high strength steel and electrical steel) - Submitted on 06/11/2020', Personal communication, 2020.
- [96] Kladnig, 'New development of acid regeneration in steel pickling plants', *Journal of Iron and Steel Research* Vol. 15 No 4, pp. 1-6, 2008.
- [97] Rituper, 'High-Performance Effluent-free Pickling Plants with Fluid Bed Hydrochloric Acid Regeneration', *Iron and Steel Engineer* Vol. 72 No 11, 1995.
- [98] Karner, 'Comments on 1st draft FMP, e-mail from Karner', Personal communication, 1999.
- [99] Agrawal et al., 'An overview of the recovery of acid from spent acidic solutions from steel and electroplating industries', *Journal of Hazardous Materials* Vol. 171, pp. 61-75, 2009.
- [100] Deutsche, 'Difussion Dialysis - An Economical Technology for Recovery of Acids From Pickling Processes', *AESF Conference on Environmental Control for the Surface Finishing Industry*, 1993.
- [101] Dahlgren, *Treatment of spent pickling acid from stainless steel production: a review of regeneration technologies with focus on the neutralisation process for implementation in Chinese Industry.*, University of Stockholm, pp. 17-18, 2010.
- [102] Luo et al., 'Diffusion dialysis-concept, principle and applications', *Journal of Membrane Science* Vol. 366, pp. 1-16, 2011.
- [103] FI, TWG member, 'Comments on 2nd draft FMP from Finland', Personal communication, 2000.
- [104] Dustou et al., 'Analytical Method to Monitor Industrial Pickling Baths Initially Constituted by HF, HNO₃', *Journal of Analytical Sciences, Methods and Instrumentation* Vol. 7, pp. 116-135, 2017.
- [105] Bos et al., 'Operational experience of coupled pickling lines / tandem cold rolling mills', 2006.
- [106] R. Woll, ZF-Getriebe GmbH, *Betriebsinterne Entsorgung von Hülschmieremulsionen Durch Kombination von Organischer Vorspaltung und Mehrstufiger Membrantechnik - Abwasserfrei und Abfallminimiert*, ZF-Getriebe GmbH, 1995.
- [107] SIDMAR, 'Personal communication SIDMAR', Personal communication, 1999.
- [108] EUROFER 19-6-17, *Eurofer contribution to Draft 1 - Proposal for Revised BAT candidates*, 2017.
- [109] Holz et al., 'Advanced technology in skin-pass rolling', *Millenium Steel – Finishing Processes*, pp. 129 – 133, 2010.
- [110] Vanroosbroeck, 'Personal communication Vanroosbroeck (3.4.99)', Personal communication, 1999.
- [111] Mello et al., 'Influence of surface texturing and hard chromium coating on the wear of steels used in cold rolling mill rolls.', *Wear* Vol. 302, pp. 1295 – 1309, 2013.
- [112] Gorbunov et al., 'Texturing or rollers for the production of auto-industry sheet', *Steel in Translation* Vol. 39 No 8, pp. 696-699, 2009.
- [113] Schmidt, 'ORC power plants recover waste heat and help to improve energy efficiency of steel mills', 2016.
- [114] Zwickel et al., 'The world's first batch annealing plant with fully automatic crane operation ensures optimal use of energy', 2015.

- [115] Comité Européen de la Tréfilerie, *The European steel wire-drawing industry: description*, 1998.
- [116] EuroStrategy, *The Community Wiredrawing Industry (Final Report)*, 1995.
- [117] N.V. Bekaert S.A., 'Company Information on Wire Technology', Personal communication, 1994.
- [118] B. Gielen, Bekaert, *Technical info*, 1998.
- [119] Gielen, 'Comments on 2nd draft FMP from Bert Gielen', Personal communication, 2000.
- [120] B. Gielen, 'Short description of processes in Wire Industry', Personal communication, 1998.
- [121] Gielen, 'Comments on 1st draft FMP from Bert Gielen', Personal communication, 1999.
- [122] R. Grommen, 'Note received on lead emissions from the use of molten lead baths for patenting or continuous annealing of steel wires, 06/11/2020', Personal communication, 2020.
- [123] Van Den Abeele L., 'The use of borax in the wire drawing process', Personal communication, 2017.
- [124] El-Hindi et al., 'A study in Waste Minimization Techniques for Modern Wire and Cable Facilities (Abstract)', *El-Hindi, L. Fitertech, Inc. USA*, 1999.
- [125] Gielen, 'Comments on 1st draft FMP from Bert Gielen, additional', Personal communication, 1999.
- [126] EUROFER, TG Coating, *Technical note on the BAT to the Integrated Pollution Prevention and Control. Draft: Coating of Steel Coil Hot Dip Process*, 1998.
- [127] Continuous Coating Shadow Group, 'Comments on 1st draft FMP from Continuous Coating Shadow Group', Personal communication, 1999.
- [128] ERM, *Technical Note on BAT to Reduce Emissions of Pollutants into the Air from the Coating of Steel Coil*, ERM-Environmental Resources Management, 1995.
- [129] EUROFER, *Technical input from EUROFER on HDC related to: 1) Applied processes and techniques, 2) Present consumption and emissions levels (20.2.2019)*, Industry association – EUROFER, 2019.
- [130] Continuous Coating Shadow Group, 'Comments on 2nd draft FMP from Continuous Coating Shadow Group', Personal communication, 2000.
- [131] ILZRO, *The Role of Aluminium in Continuous Hot-Dip Galvanizing*, 2003.
- [132] Dallin, *Continuous hot-dip galvanizing – process and products*, 2015.
- [133] Rentz, O., *BAT in the German Ferrous Metals Rolling Industry Final*, DFIU, 1999.
- [134] EURFOER, 'Input from CC-Shadow Group', Personal communication, 1999.
- [135] Dinter et al., 'Optimization of the Chemcoater process to passivate galvanised steel strip in galvanising line no. 8 of Thyssen Krupp Steel', 2006.
- [136] Thuau, 'EUROFER (25.5.2020)', Personal communication, 2020.
- [137] ArcelorMittal Kessales, *Press Release ArcelorMittal Kessales - Jet Vapour deposition*, 2017.
- [138] EGGA, 'EGGA Statistical Report, 2019', Personal communication, 2019.
- [139] EGGA - a, *Briefing note on General Galvanizing industry*, EGGA European General Galvanizers Association, 1998.
- [140] UK Galvanisers, 'Comments on 2nd draft FMP from UK Galvanisers', Personal communication, 2000.
- [141] Welzel, 'Maßnahmen zur Emissionsminderung bei Feuerverzinkungsanlagen', *Haustechnik - Bauphysik - Umweltechnik* Vol. 100 No H.11, p. gi S 10/340, 1979.

References

- [142] Hageböling, V., 'Zinkopal - A new dimension in corrosion protection for small parts', *Intergalva 1997*, 1997.
- [143] EGGA, 'Comments on 1st draft FMP from EGGA', Personal communication, 1999.
- [144] ABAG, *Vermeidung von Abfällen durch abfallarme Produktionsverfahren – Feuerverzinkereien*, ABAG - Abfallberatungsagentur des Landes Baden-Württemberg, 1993.
- [145] DK, TWG member, 'Comments on 1st draft FMP from Denmark', Personal communication, 1999.
- [146] EGGA, 'Comments on 2nd draft FMP from EGGA', Personal communication, 2000.
- [147] VDI, *Emission Control Hot-Dip Zinc Galvanising Plants*, 2008.
- [148] IT 18-4-17, *Italy contribution to Draft 1 - Proposal for Revised BAT candidates*, 2017.
- [149] Wedge Group, 'Comments on 2nd draft FMP from Wedge Group', Personal communication, 2000.
- [150] Danish EPA, *Batch Hot-dip Coating of Fabricated Steel Products (BAT-note)*, Danish Environmental Protection Agency, 1993.
- [151] DE, *Information submission by DE*, 2019.
- [152] EGGA, 'EGGA personal communication dated 03/02/2021', Personal communication, 2021.
- [153] Piatkiewicz, 'Personal Communication Galvanizers Association (Mr. Piatkiewicz 19.9.99)', Personal communication, 1999.
- [154] FI, TWG member, 'Comments on 1st draft FMP from Finland', Personal communication, 1999.
- [155] P. Kunz, *Reststoffvermeidung durch ein biologisches Entfettungsspülbad in einer Feuerverzinkerei*, ABAG - Abfallberatungsagentur des Landes Baden-Württemberg, 1996.
- [156] Cullivan, 'Zero Discharge Yields Enhanced Production', *Intergalva (IG) 1997*, 1997.
- [157] Sprang, *New Separation Techniques for Galvanizing Plants*, 1997.
- [158] Stone, *The Whys and Hows of Hydrochloric Acid Pickling*, Esco Engineering, 1997.
- [159] Stone, *Economical fume control in pickle house*, 1998.
- [160] BG Q 198, *Iron Sulphate recovery from pickling baths with Sulphuric acid solution and Pickling by Sulfuric Acid Solution for Galvanized Tubes Production*, 2018.
- [161] DE TWG member, *Proposal for a new BAT candidate for Batch Galvanizing: 8.8.4.5 Enclosed pretreatment section with air extraction and purification by a wet scrubber*, UBA Germany, 2019.
- [162] American Galvanizers Association, *Effects of Adding Pure or Scrap American Galvanizer's Association*, 2015.
- [163] COM, *DG Environment: What is Emas?*, 2010.
- [164] IAF, *International Accreditation Forum website*, 2010.
- [165] EU, 'Regulation (EC) No 1221/2009 of the European Parliament and of the Council of 25 November 2009 on the voluntary participation by organisations in a Community eco-management and audit scheme (EMAS), repealing Regulation (EC) No 761/2001 and Commission Decisions 2001/681/EC and 2006/193/EC', *Official Journal of the European Union* Vol. L 342, 22.12.2009, pp. 1-45, 2009.
- [166] CEN, *EN ISO 14001:2015 Environmental management systems – Requirements with guidance for use*, 2015.
- [167] Pinasseau et al., *Best Available Techniques (BAT) Reference Document for Waste Treatment (WT BREF)*, JRC Seville. European Commission, 2018.

- [168] COM, *Best Available Techniques (BAT) Reference Document for Common Waste Water and Waste Gas Treatment/Management Systems in the Chemical Sector (CWW BREF)*, European Commission, Joint Research Centre, Seville, EUR 28112 EN, doi:10.2791/37535, European Commission, JRC IPTS EIPPCB, 2016.
- [169] HAZBREF, *HAZBREF Work Package 3, Activity 3.2: Methods to include information on hazardous and other substances of concern more systematically in the BREFs*, 2021.
- [170] Brinkmann et al., *JRC Reference Report on Monitoring of Emissions to Air and Water from IED Installations (ROM REF)*, European Commission, Joint Research Centre, Seville, EUR 29261 EN, doi: 10.2760/344197, 2018.
- [171] COM, *Best Available Techniques (BAT) Reference Document for Energy Efficiency (ENE BREF)*, European Commission, JRC-EIPPCB, 2009, 2009.
- [172] EN standard 16247-1, 'EN 16247-1:2012, Energy audits – Part 1: General requirements', 2012.
- [173] ISO standard 50002, 'ISO standard 50002:2014. Energy audits – Requirements with guidance for use.', 2014.
- [174] ETSU, *Oxygen trim on a steel reheat furnace*, Energy Technology Support Unit ETSU - Best Practice Programme, 1995.
- [175] Scheuermann et al., 'New developments in hydrogen annealing of steel coils', *MPT International* Vol. 2, pp. 90-98, 1995.
- [176] Wendt et al., *Modernisation of existing industrial furnace plants*, pp. 81-90, 2015.
- [177] Arnold et al., 'Strategie und Anlagentechnik der Energiewirtschaft der Preussag Stahl AG', *Stahl und Eisen* Vol. 113 No 10, 1993.
- [178] Anstots et al., 'The New Annealing and Pickling Line for the Wide Stainless Strip in the Krefeld Works of Thyssen Stahl AG', *Metallurgical Plant and Technology International* Vol. 17 No 1, 1994.
- [179] Finland, TWG member, 'Personal Communication Finland (28.3.98)', Personal communication, 1998.
- [180] Ipek et al., 'Electrolytic pickling of duplex stainless steel', *Materials and Corrosion* Vol. 56, pp. 521 – 532, 2005.
- [181] Brown C., 'Mixed acid recovery with the APU™ acid sorption system', 1999.
- [182] Pempera et al., 'Turbulence Pickling Technology for Carbon Steel and Stainless Steel Strip (abstract)', *International Conference 21st Century Steel Industry of Russia and CIS*, Metallurgica, 1994.
- [183] EGGA - b, 'Personal communication EGGA', Personal communication, 1999.
- [184] EGGA - a, 'Personal communication EGGA', Personal communication, 1999.
- [185] Choice et al., 'A continuous electrolytic preflux treatment unit', 1998.
- [186] Karner et al., 'Modern Pickling and Acid Regeneration Technology', *Metallurgical Plant and Technology International* Vol. 19 No 2, 1996
- [187] Rituper, *Beizen von Metallen (Schriftenreihe Galvanotechnik)*, Eugen G. Leuze Verlag Saulgan, 1993.
- [188] COM, *Reference Document on the application of Best Available Techniques to Industrial Cooling Systems*, 2001.
- [189] EUROFER, TG Cold Rolling, *Technical note on the BAT to the Integrated Pollution Prevention and Control. Draft: Hot Rolling Mill, Chapter 2*, 1998.
- [190] EGGA, 'Note from EGGA (Murray Cook) on emissions from degreasing baths in batch galvanising (Submitted on 06/11/2020)', Personal communication, 2020.
- [191] Stone, *The Whys and Hows of Pickle Line Fume Scrubbers*, Esco Engineering, 1998.

References

- [192] EPA, *National Emission Standards for Hazardous Air Pollutants for Steel Pickling – HCl Process Facilities and Hydrochloric Acid Regeneration Plants – Background Information for Promulgated Standards (EPA-453)*, U.S. Environmental Protection Agency, Office of Air Quality Planning and Standards, Research Triangle Park, NC 27711, December 1998, No. EPA-453/R-98-010b, 1998.
- [193] Sanders, 'Hydrogen Peroxide technology for NO_x Suppression and Nitric Acid-free Pickling of Stainless Steel Wire and Wire Production', *Wire Industry* Vol. 64-10 No 766, 1997.
- [194] UK, EA, *Chief Inspector's Guidance to Inspectors, Process Guidance Note IPR 4/11 (Processes for the Manufacture or recovery of Nitric Acid and Processes Involving the Manufacture or Release of Acid-Forming Oxides of Nitrogen)*, 1993.
- [195] Pengidore et al., 'Chemical Pickling Process at Alleghy Ludlum's no 91 Anneal and Pickle Line', *AISE annual convention*, 1996.
- [196] EGGA, *Smoke-reduced flux agent*, 2019.
- [197] Riekehof, W., 'Emission control of air pollutants in Hot Dip Galvanizing Plants', 1994.
- [198] Hähn, *Entwicklung einer fortschrittlichen Minderungs-technologie zur Luftreinigung an einer Feuer-verzinkungsanlage*, 1993.
- [199] BE, TWG member, 'Comments on 2nd draft FMP from Belgium', Personal communication, 2000.
- [200] Ackermann et al., *Altanlagenprogramm des Bundesministers des Innern Verminderung der Emissionen einer Feuerverzinkungsanlage für Fertigtelle*, 1987.
- [201] AT, TWG member, 'Comments on 2nd draft FMP from Austria', Personal communication, 2000.
- [202] World Patent, *Method in Connection with Steel Production. World Patent No. WO2005/098054*, World Intellectual Property Organisation - International Bureau, 2005.
- [203] Schneiker et al., 'Hydrofluss - Recycled Hazardous waste', *3rd International Conference on Process Development in Iron and Steelmaking*, Lulea, Sweden, 8-11 June, 2008.
- [204] ES, TWG member, 'Comments on 1st draft FMP from Spain', Personal communication, 1999.
- [205] Nyman et al., 'The Outokumpu process for pickling acid recovery.', 1986.
- [206] BE, 'Technical descriptions and applicability BE comments', Personal communication, 2021.
- [207] EUROFER, 'EUROFER further input to FMP BREF revised D1 (Submitted 02/03/2021)', Personal communication, 2021.
- [208] EUROFER, 'Annexes to EUROFER comments to FMP BREF Pre-Final Draft (Alexis Thuau, 08/09/2021)', Personal communication, 2021.
- [209] FMP TWG, *Comment received on technique: Use of electricity from fossil-free sources*, 2022.
- [210] UNEP, *Workshop of the Implementation of Energy Efficiency in Re-heating Furnace In Steel Industries*, 2014.
- [211] EGGA, 'Adapted VDI chart', Personal communication, 2022.
- [212] Steve Andrews, *Wire drawing industry in Europe*, 2022.
- [213] EGGA, *Thin film coating in batch galvanising*, 2022.

GETTING IN TOUCH WITH THE EU

In person

All over the European Union there are hundreds of Europe Direct centres. You can find the address of the centre nearest you online (european-union.europa.eu/contact-eu/meet-us_en).

On the phone or in writing

Europe Direct is a service that answers your questions about the European Union. You can contact this service:

- by freephone: 00 800 6 7 8 9 10 11 (certain operators may charge for these calls),
- at the following standard number: +32 22999696,
- via the following form: european-union.europa.eu/contact-eu/write-us_en.

FINDING INFORMATION ABOUT THE EU

Online

Information about the European Union in all the official languages of the EU is available on the Europa website (european-union.europa.eu).

EU publications

You can view or order EU publications at op.europa.eu/en/publications. Multiple copies of free publications can be obtained by contacting Europe Direct or your local documentation centre (european-union.europa.eu/contact-eu/meet-us_en).

EU law and related documents

For access to legal information from the EU, including all EU law since 1951 in all the official language versions, go to EUR-Lex (eur-lex.europa.eu).

Open data from the EU

The portal data.europa.eu provides access to open datasets from the EU institutions, bodies and agencies. These can be downloaded and reused for free, for both commercial and non-commercial purposes. The portal also provides access to a wealth of datasets from European countries.

The European Commission's science and knowledge service

Joint Research Centre

JRC Mission

As the science and knowledge service of the European Commission, the Joint Research Centre's mission is to support EU policies with independent evidence throughout the whole policy cycle.



EU Science Hub
joint-research-centre.ec.europa.eu



@EU_ScienceHub



EU Science Hub - Joint Research Centre



EU Science, Research and Innovation



EU Science Hub



EU Science



Publications Office
of the European Union