



JRC SCIENCE FOR POLICY REPORT

JRC Wind Energy Status Report 2016 Edition

*Market, technology and
regulatory aspects of
wind energy*

Cristina Vázquez Hernández

Thomas Telsnig

Anahí Villalba Pradas

2017



This publication is a Science for Policy report by the Joint Research Centre (JRC), the European Commission's science and knowledge service. It aims to provide evidence-based scientific support to the European policymaking process. The scientific output expressed does not imply a policy position of the European Commission. Neither the European Commission nor any person acting on behalf of the Commission is responsible for the use that might be made of this publication.

Contact information

Name: Cristina Vázquez Hernández
Address: Joint Research Centre, Directorate for Energy, Transport and Climate Change, P.O. Box 2, 1755 ZG Petten, The Netherlands
Email: cristina.vazquez-hernandez@ec.europa.eu
Tel.: +31 224 56-5073

JRC Science Hub

<https://ec.europa.eu/jrc>

JRC105720

EUR 28530 EN

PDF	ISBN 978-92-79-66940-8	ISSN 1831-9424	doi:10.2760/332535
Print	ISBN 978-92-79-66939-2	ISSN 1018-5593	doi:10.2760/85725

Luxembourg: Publications Office of the European Union, 2017

© European Union, 2017

The reuse of the document is authorised, provided the source is acknowledged and the original meaning or message of the texts are not distorted. The European Commission shall not be held liable for any consequences stemming from the reuse.

How to cite this report: Vazquez Hernandez, C.; Telsnig, T.; Villalba Pradas, A.; JRC Wind Energy Status Report - 2016 Edition. EUR 28530 EN. Luxembourg: Publications Office of the European Union; 2017. JRC105720; doi:10.2760/332535

All images © European Union 2017, except cover page: © Fotolia

Title JRC Wind Energy Status Report – 2016 Edition

This report presents the status and development of main market, technology and regulatory issues of onshore and offshore wind energy. Global installed capacity reaches a new record year after year. This intense growth is enabled by the strong and fast technological development of wind energy and new solutions and innovations that continuously emerge aiming to reduce the energy cost. As technology is becoming more competitive, policy support in EU Member States keeps adapting.

JRC Wind Energy Status Report – 2016 Edition

Joint Research Centre

Directorate for Energy, Transport and Climate

Cristina Vázquez Hernández

Thomas Telsnig

Anahí Villalba Pradas

2017

Page intentionally left in blank

EXECUTIVE SUMMARY

This report presents the market status and the technology development of onshore and offshore wind energy. It addresses the latest technological developments in the sector and outlines the policy support at European level.

In 2015 the global market showed a new record in annual installations. In total about 64 GW of wind turbines were installed; an increase of 20 % compared to 2014 levels. Global cumulative installed capacity reached about 430 GW of which, about 140 GW (producing around 300 TWh/annually) were operating within the boundaries of the European Union. China overtook the EU in terms of installed capacity (145 GW vs 140 GW). However, China's grid connected capacity lags behind due to the slow grid development and curtailment measures: about 130 GW in China versus 140 GW in the EU.

The offshore wind market still represents only a small share of the total wind energy deployment. Figures show that between 2010 and 2015 the share of offshore capacity installed increased from 1 % (3.8 GW) to 3 % (12.2 GW) of the total wind installations. Starting from 2010 the global offshore wind market showed stable annual deployment rates between 0.9 GW and 2.8 GW. Most recently European deployment rates showed an increase of about 29 % from the 1.8 GW in 2014 to 2.3 GW in 2015 as a consequence of the strong offshore market in Germany in 2015. The global offshore wind farm project pipeline in 2016 indicated that some 13.8 GW of turbines were in pre-construction, under construction or partial generation. If projects are taken into consideration whose consent application has been authorised and where the start of operation is envisaged for 2020 about 22.6 GW would be added to the current operational capacity. This means that a total of about 34.8 GW of global offshore wind capacity could be commissioned by 2020.

Wind energy technology continues to evolve towards longer blades, uprated electric generators and taller towers.

In onshore wind market, wind turbines installed in Europe in 2015 displayed the highest average rated power compared to other regions representing 2.4 MW while wind turbines in North American and Asian markets reached the largest average rotor diameters representing 101 m in both cases.

The evolution towards taller towers and longer blades is leading to an increasing trend of onshore wind turbines aimed at medium and low wind speed locations, especially in Asia and North America. As a consequence, the specific power¹ of new wind turbines installed is decreasing.

Regarding drive train configuration, geared wind turbines with DFIGs (Doubly Fed Induction Generators) continue to be the preferred solution in the global market. Nevertheless, they are increasingly losing share in favour of arrangements with full-power converters (both direct drive and hybrid arrangements) as nominal power of new wind turbines increases. This trend is especially prominent in the European market.

Permanent magnet generators continue to be mainly employed in geared wind turbines in Europe, most likely because of the reduced size and weight of the generator and consequently less rare earths required. The Asian market, which historically displayed a predominance of permanent magnet generators in direct drive configuration, has started to increasingly use this type of generator in geared wind turbines in most recent years.

In the offshore wind market, the upward trend towards longer blades, uprated electric generators and taller towers is less pronounced than onshore. The evolution from geared wind turbines with DFIGs to full

¹ Specific power is the nominal power per swept rotor area.

power converter drive train configurations is especially strong, with increasing direct drive and hybrid arrangements in Asia and Europe, respectively.

Even though offshore wind projects are becoming larger, further located from shore and at deeper waters, monopiles are currently and are expected to continue to be the most commonly used fixed ground foundations.

Scaling up wind turbines represent one of the main challenges faced by the wind industry. As a consequence a larger number of latest technological developments are especially focused on implementing modular approaches in wind turbine components, not only in towers and blades but also in updated electric generators and offshore substations. Furthermore, completely innovative wind turbine concepts and technologies emerge with the purpose of increasing energy capture, optimizing operation and eventually reducing the cost of energy.

In terms of scientific publications and participation in EU granted projects in key wind turbine components, blades, electric generators and offshore foundations show the highest percentage of documents retrieved in the period 2011-2015. Asia is the main player followed by Europe. Almost 90 % of contributions come from the public sector, led by Aalborg University.

Although current support schemes for wind energy vary across EU Member States, a transition from feed-in tariffs to competitive tender-based schemes can be witnessed. As of July 2016, nine EU MSs for onshore wind energy and seven EU MSs for offshore had competitive tender-based support schemes in force for new installations. However, only three EU MSs offered a tender-based feed-in premium, namely Croatia (onshore), The Netherlands (on- and offshore) and Denmark (offshore). Moreover, regulatory changes to meet the State Aid Guidelines for Environmental protection and Energy (EEAG) 2014-2020 are in progress or development in Germany, Hungary, Ireland, Slovakia, Finland and Lithuania.

TABLE OF CONTENTS

1	Introduction.....	1
2	Market status and development.....	3
2.1	Onshore wind market.....	3
2.2	Offshore wind market.....	4
2.3	Turbine manufacture market.....	6
2.4	Offshore wind installations market.....	7
3	Technology status and development.....	9
3.1	Onshore wind energy.....	9
3.1.1	Rated power.....	9
3.1.2	Project size.....	9
3.1.3	Wind class and specific power.....	10
3.1.4	Blades.....	11
3.1.5	Towers.....	12
3.1.6	Drive train configuration.....	12
3.2	Offshore wind energy.....	15
3.2.1	Rated power.....	15
3.2.2	Project size.....	15
3.2.3	Specific power.....	16
3.2.4	Blades.....	16
3.2.5	Towers.....	16
3.2.6	Drive train configuration.....	17
3.2.7	Foundations.....	18
3.2.8	Electricity infrastructure: offshore transmission system.....	22
3.3	Latest technological developments and future deployments.....	23
3.3.1	Key wind turbine components.....	23
3.3.2	Specific offshore wind turbine components.....	25
3.3.3	New wind turbine concepts.....	26
3.4	Scientific publications and participation in EU granted projects in key wind turbine components.....	27
3.4.1	Scientific publications and participation in EU granted projects by geographical zones.....	27
3.4.2	Scientific publications and participation in EU granted projects by sectors.....	29
4	EU Horizon 2020 framework programme.....	31
5	Regulatory framework in the EU MSs.....	35
6	References.....	37
	APPENDIX A JRC WIND ENERGY DATABASE.....	41
	APPENDIX B WIND CLASSES.....	43
	APPENDIX C DRIVE TRAIN CONFIGURATION.....	44
	APPENDIX D SCIENTIFIC PUBLICATIONS AND PARTICIPATION IN EU FUNDED PROJECTS IN KEY WIND TURBINE COMPONENTS.....	45
	APPENDIX E SUPPORT SCHEMES FOR NEW WIND ENERGY PROJECTS AND GRID ISSUES.....	47

ACKNOWLEDGMENTS

The authors would like to thank the following individuals for reviewing this document: Dr Andreas Uihlein, Dr Davide Magagna, Dr Evangelos Tzimas, Dr Estathios Peteves, Dr Ricardo Fernández Blanco Carramolino and Dr Géraldine Joanny from the JRC and Dr Javier Serrano González from the University of Seville.

1 Introduction

The European Strategic Energy Technology Plan (SET-Plan) aims to accelerate the development and deployment of low-carbon technologies. The communication on the Integrated SET Plan (published in September 2015) identified offshore wind energy within its ten priority actions to accelerate the energy system transformation and create jobs and growth. Particularly, the technological leadership in offshore wind should be maintained by supporting the development of the next generation of renewable energy technologies. Moreover, priority is given to the cost reduction of key technologies through regional cooperation. In case of offshore wind regional cooperation on deployment, grid development and maintenance technologies in the Northern and Baltic Seas can help to achieve further cost reductions [1].

Agreed strategic targets for offshore wind energy

- 1. Reduce the levelised cost of energy (LCoE) at final investment decision (FID) for fixed offshore wind* by improvement of the performances of the entire value chain to**
 - **less than 10 ct€/kWh by 2020** and to
 - **less than 7ct€/kWh by 2030;**
- 2. Develop cost competitive integrated wind energy systems including substructures which can be used in deeper waters (>50m) at a maximum distance of 50 km from shore with a LCoE* of**
 - **less than 12 ct€/kWh by 2025** and to
 - **less than 9 ct€/kWh by 2030**

* the costs for delivering the electricity to onshore substations are taken into account within the LCoE

Figure 1 Strategic targets for offshore wind energy

Based on the priorities set in SET plan, representatives of the EC, the EU Member states and the SET plan stakeholders have formulated in January 2016 a "Declaration on Strategic Targets in the context of an Initiative for Global Leadership in Offshore

Wind" [2]. The declaration aims to maintain the European leadership in offshore wind and defines two key issues that should be tackled to increase the competitiveness of technology:

1. Reduction of offshore wind costs (e.g. through increased performance and reliability)
2. The necessity to develop integrated wind energy systems including floating substructures for deeper waters or other marine climatic conditions, to increase the deployment possibilities

Figure 1 depicts the agreed strategic targets for offshore wind energy.

Most recently the outcomes of the competitive tenders for the offshore wind projects Horns Rev III, Borselle 1 and 2, Vesterhav Nord and Syd and finally Kriegers Flak have shown that at least bidding prices undercut the 2020-target set for offshore wind. This might be an indication that an update of the targets might be necessary. A cost target including site specific assumptions such as distance to shore and water depth might help to understand bidding prices and facilitate the reach of ambitious cost targets.

The "Clean Energy For All Europeans" package published by the European Commission end of November 2016 addresses in its key aim "Achieving global leadership in renewable energies" among others the importance of wind energy. The wind energy sector accounts for the majority of renewable energy jobs in the EU. In the period between 2005 and 2013, the turnover of the wind energy sector in Europe has increased eightfold, with its revenue in the EU estimated to be around EUR 48 billion. In the same period, wind energy employment in the EU has increased fivefold from 2005 to 2013, with total associated employment numbers of about 320 000 in 2014 [3].

As one of the main instruments of the SET-Plan, the SET-Plan Steering group ensures the alignment of the research and innovation activity undertaken on European and on

national level. In case of wind energy the European Technology and Innovation Platform on Wind Energy (ETIP Wind) is a forum to support the SET-Plan and to bring together EU MSs, industry and research to promote the market uptake of wind energy. In 2016, ETIP Wind published its Strategic research and innovation agenda 2016 and introduced its strategic vision to shape future research and innovation priorities [4]. The agenda recommends that future efforts focus on the following five key challenges:

1. Grids systems, integration and infrastructure
2. Operation and Maintenance
3. Industrialisation
4. Offshore Balance of Plant
5. Next generation technologies

In line with those targets the research collaboration on national level is fostered by the European Energy Research Alliance (EE-RA) with the aim to achieve a more strategic approach in knowledge sharing. Moreover, the Joint Programme on Wind Energy integrates the resources in the joint research activities described in the Integrated Research Programme on Wind Energy (IRP Wind) [5].

2 Market status and development

2015 brought a new annual record with about 64 GW of wind turbines installed in the world, a 20 % increase compared to the 53 GW installed in 2014². The global cumulative installed capacity reached about 430 GW (Figure 2). Whereas since 2005 the installed capacity offshore boomed from less than 700 MW to about 12 GW, onshore installations expanded from 58 to 422 GW, which represents an average annual growth of 20 %.

The global installed capacity produced approximately 850 TWh of electricity in 2015³, or approximately 4 % of the 2015 estimated global final electricity consumption⁴.

Over the last few years annual European commissioned capacity has remained at between 10 GW and 13 GW. Stability is therefore the norm; with offshore wind and new onshore markets likely to push up annual figures to around 11–15 GW per year for the next 4 to 6 years.

China overtook the European Union in terms of installed capacity (145 GW vs 140 GW) although not in terms of grid connected capacity due to China's slow grid development and curtailment measures: about 130 GW in China versus 140 GW in the EU.

2.1 Onshore wind market

European countries added in total 12.2 GW or 20 % of the world onshore wind capacity in 2015, with Germany (5.1 GW) followed by Poland (1.27 GW) and France (1.07 GW) as the only three European countries installing more than 1 GW in 2015. The rest of Europe installed in total 4.8 GW with Turkey at the forefront adding 956 MW onshore capacity to the grid.

The European cumulative commissioned onshore wind capacity grew by 10 % in 2015 and, as in the case of 2014 this figure is significantly below 16.9 % global average.

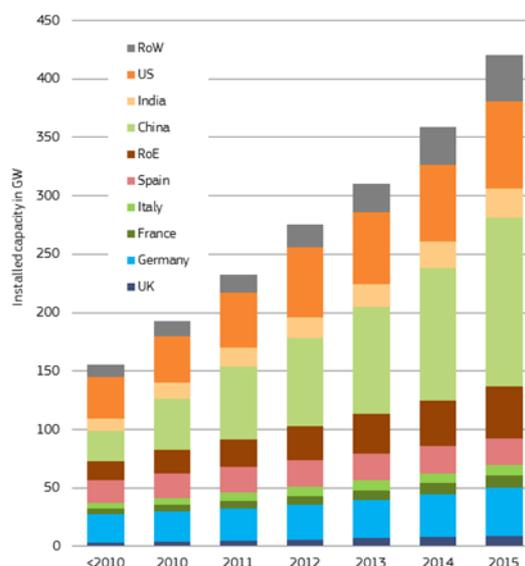

Figure 2 Cumulative worldwide installed onshore wind capacity 2010-2015

Sources: [6] and annual reports by WindEurope, country presentations at IEA Wind Executive Committee meetings, and JRC Wind Energy database.

Note: RoE means Rest of Europe; RoW means Rest of the World. Decommissioning capacity has not taken into account.

The strength of the German market in 2015, as in 2014, induced high dependency of the European sector on installations in that country. Besides, the Top 4 markets in new installed onshore capacity (Germany, Poland, France and Turkey) covered 68 % of all European installations. The Top 4

² Global figures for annual installations have been subjected to a methodological drawback. Whereas for China the milestone used by the source was "installed" capacity, for the rest of the world the milestone was "commissioned" capacity. Thus, for example while German offshore wind turbine installed in 2014 and connected to the grid in 2015 are reported in 2015, the opposite applies to Chinese: installations are reported in the year turbines are installed even when sometimes they are connected to the grid the following year.

³ Assuming a global average capacity factor of 23.8 % for onshore and 41 % for offshore which means an overall capacity factor of 24.3 %.

⁴ According to IEA Electricity Information 2014 (IEA, 2014, p. III.4) the final consumption in 2012 was calculated at 18 912 TWh. Assuming a 5 %, 3 % and 2 % growth in 2013, 2014 and 2015, mostly due to the Chinese and Indian market, this gives a 4 % contribution from 850 TWh of wind electricity.

markets only covered 64 % in 2014, 55 % in 2013 and 49 % in 2012.

Figure 2 shows that Germany (42 GW) and Spain (23 GW) led Europe in terms of cumulative onshore capacity at the end of 2015 followed by France with 10 GW, Italy and the United Kingdom (9 GW each). In total all European countries account for 137 GW of onshore wind energy.

In 2015, China led new installations in onshore wind with about 30 GW and a global market share in onshore wind of about 48 %. This new capacity involves year-on-year growth of 30 % or 7 GW. For the last 7 years China has added capacity at a very high level and has been the world market leader [7]. At the end of 2015, a cumulative onshore capacity of 144 GW was reached, a 27 % increase compared to 2014. Thus, in 2015 China overtook Europe in terms of cumulative installed capacity – although not in terms of grid-connected capacity.

The Indian market increased further from 2.3 GW in 2014 to 2.6 GW in 2015 (a 13 % growth rate), although this was still lower than the 2014 increase of 0.6 GW or the 2011 record of 3 GW. In terms of cumulative installed capacity in 2015, India led the rest of Asia with 25 GW, the fifth world market. Other Asian countries like Japan and Korea finally reached significant annual deployment during 2015, after years with very low level of annual installations. Finally, it is perhaps interesting to remark Pakistan, with 103 MW, and what can be the beginning of very significant installation levels.

The United States market recovered and further grew in 2015 with 8.6 GW from 4.85 GW installed in 2014 (a 77 % growth rate). The US ended the traditional intermittent character of its main support schemes, the Production Tax Credit (PTC) and the Investment Tax Credit (ITC) with a stepped reduction to fully abandon them by 2020.

Despite the problems in the Brazilian economy, in 2015 this country was still ahead of India (and fourth world market overall) in terms of annual installations with

2.75 GW commissioned⁵, (an 11 % growth rate), to reach 8.7 GW of cumulative capacity. The lack of transmission lines to the windiest areas of the country constitutes the main bottleneck, whereas the suspension of governmental financing is the main threat. The important markets of Chile and Uruguay displayed a reduction in annual installations to 169 MW and 316 MW respectively (from 506 MW and 405 MW in 2014) although they both approach the 1-GW mark in cumulative capacity: 933 MW Chile and 845 MW Uruguay [6]. The performance of Peru and Argentina was disappointing with no or nearly no installations in 2015.

South Africa presented another excellent year with 483 MW of new installations after the 560 MW in 2014, and with 1.05 GW it became the African leader in both annual and cumulative installations overtaking Morocco and Egypt.

At a lower deployment rate than the last years, Australia installed 380 MW.

2.2 Offshore wind market

Starting from 2010 the global offshore wind market showed stable annual deployment rates between 0.9 GW and 2.8 GW. Most recently global deployment rates showed an increase of about 44 % from the 1.9 GW in 2014 to 2.8 GW in 2015.

Compared to onshore wind, offshore installations still have only a small but increasing share in total wind energy deployment. Between 2010 and 2015 the share of offshore capacity installed increased from 1 % to 3 % of the total wind installations.

Figure 3 shows a significant increase in newly installed European offshore wind farms from 2014 (1.8 GW) to 2015 (2.3 GW), which means a 29 % increase year-on-year. As first estimates for 2016 indicate [8], the annual deployment rate in Europe will first decrease to about 1.5 GW

⁵ GWEC (2015) reports that 334 MW of these were still not connected to the grid at the end of 2014.

and then increase again at values between 3 to 3.5 GW per year between 2017 and 2019. This is mainly caused by the high number of projects that started construction in 2016.

The global cumulative offshore capacity installed in 2015 displays the United Kingdom (5.1 GW) and Germany (3.3 GW) as forerunners followed by Denmark with 1.3 GW, China (0.9 GW), Belgium (0.7 GW) and the Netherlands (0.5 GW). In total all European countries accounted for 11.1 GW of the global offshore wind capacity (12.2 GW) in 2015.

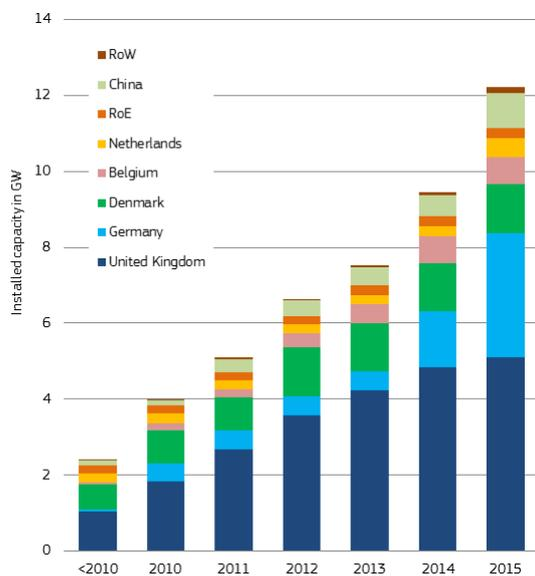

Figure 3 Cumulative worldwide installed offshore wind capacity 2010-2015. Source: JRC wind energy database

Note: Total installed capacity of offshore project is counted at the time the first turbine is connected to the grid.

RoE means Rest of Europe; RoW means Rest of the World. Decommissioning capacity has not been taken into account.

The global offshore wind farm project pipeline indicated that some 13.8 GW of turbines were in pre-construction, under construction or partial generation. If projects are taken into consideration whose consent application has been authorised and where the start of operation is envisaged for 2020 about 22.6 GW would be added to the current operational capacity. This means that a total of about 34.8 GW of global offshore wind capacity could be commissioned by 2020.

The Chinese Wind Energy Association reported that some 360 MW of turbines were installed offshore in China during 2015. However, it has to be noted that Chinese data might not be accurate enough. In effect, CWEA states that 360 MW were installed in 2015 in Chinese offshore and intertidal plants [9] but a verification of one of the wind farms listed, the Putian Pinghai bay offshore demonstration project phase 1, near Cormorants Island, shows that only two of the ten turbines were installed in 2015 and the rest in 2016.⁶ Only half of those turbines were installed in intertidal areas and the others in pure offshore wind farms.

Other promising offshore wind markets in 2015 were Vietnam and Japan. In Vietnam Phase two of the Bac Lieu wind farm (83.2 MW) was installed and commissioned in the Mekong river delta. In Japan, the second turbine of the 3-turbine floating experimental wind farm (the prototype Mitsubishi Sea Angel 7 MW) and the third turbine (a 5-MW Hitachi) were floated to the site in 2015 and in July 2016, respectively.

The first US offshore wind farm (Block Island Wind Farm close to Rhode Island) is operating since December 2016. Only four of the five 6 MW wind turbines are online, as one turbine broke down in early November during a routine testing. It is expected that the last turbine will come online end of January 2017 [10]. Recent developments in the US offshore wind market include the allocation of new sites or areas and changes to major R&D projects. The new project known as Deepwater One, a 90 MW wind farm between New York and Long Island, is close to obtain permitting.

Besides the commercial projects, several offshore wind prototypes and research projects are realised in the US. The 125 kW Keuka Rim Drive/Liquid Air Storage prototype is used to power an air liquefaction [11].

⁶ The corresponding Chinese data in Figure 3 was reduced to 320 MW.

The advanced foundations projects are supported by the [Offshore Wind Advanced Technology Demonstration Program](#) of the Department of Energy. Two of the three selected projects were dropped (Dominion Power’s Virginia Offshore Wind Technology Advancement Project, and Principle Power’s WindFloat Pacific) and replaced with University of Maine’s Aqua Ventus I and Lake Erie Energy Development Corporation’s Icebreaker. The third project, Fishermen’s Atlantic City Windfarm is still in the programme [12].

2.3 Turbine manufacture market

The wind turbine market continues growing and attracting new entrants, in particular in China and India. The recent mergers and acquisitions among Western OEMs (Original Equipment Manufacturers) suggest a desire or need for Western companies to become stronger in order to face the expected expansion of Chinese manufacturers abroad.

The Chinese role as a forerunner in new installed capacity is accompanied by a strong local market for turbines. Chinese OEMs supply 97.3 % of Chinese wind power plants with turbines whilst their participa-

tion on foreign markets remains negligible so far. Nevertheless, the strong Chinese home market resulted for the first time in a Chinese company (Goldwind) leading the ranking of turbine manufacturers in terms of installed capacity. European turbine manufacturer Vestas ranked second. With Siemens, Gamesa and Enercon three additional European companies can be found in the Top 10 (Figure 4).

The annual composition of the Top 10 OEMs per market share is an indicator of how the market has shifted in two ways: (a) influenced by national market developments and (b) overall towards China.

In the period 2010-2015 China contributed between 35 % to 50 % of the annual world installations. During this time at least three Chinese manufacturers populated the Top 10. As mentioned before, for the first time in 2015 a Chinese company led the world ranking and five Chinese companies were among the Top 10. Consolidation is still ongoing in China where the Top 10 manufacturers had a market share of about 80 % in 2014 and the number of manufacturers is expected to decrease [13].

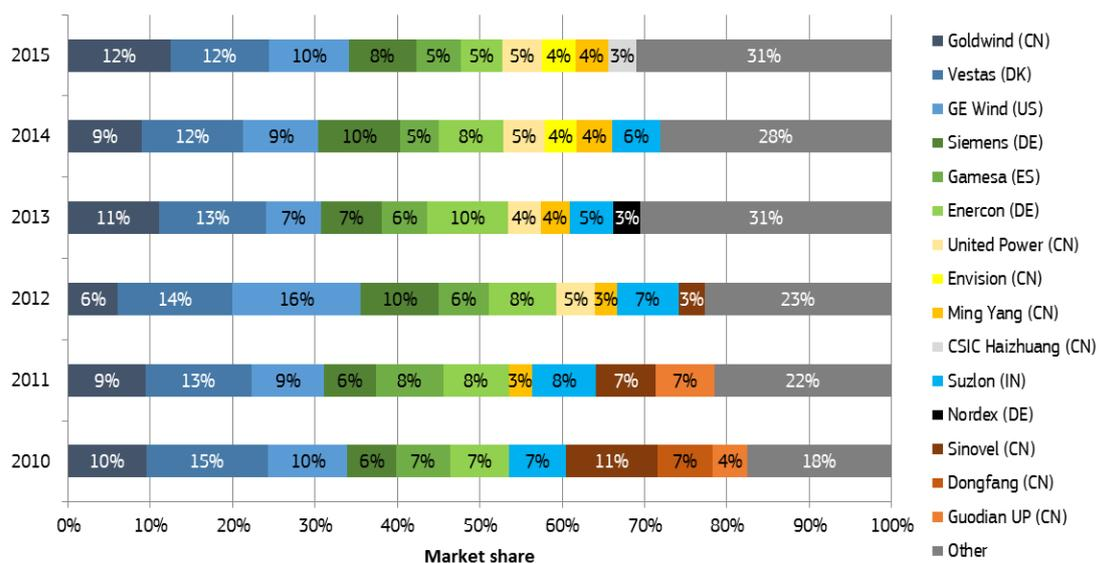

Figure 4 Evolution of the Top 10 turbine manufacturers 2010-2015
 Source: BTM Consult for 2010-2014 and JRC data for 2015. Servion, formerly called REpower, was part of the Suzlon group from 2010 to 2014 and it is therefore included as Suzlon during that period.

The turbine market shows a trend towards lower concentration, with the five largest firms together covering about 47 % of the market in 2015, 0.4 percentage points lower than previous year (Figure 5).

The rate of reduction of market share of the Top 5 OEMs was steep from 2005 to 2009, and it has slowed down since then, showing certain stability until 2015 ranging between 47 % and 55 %.

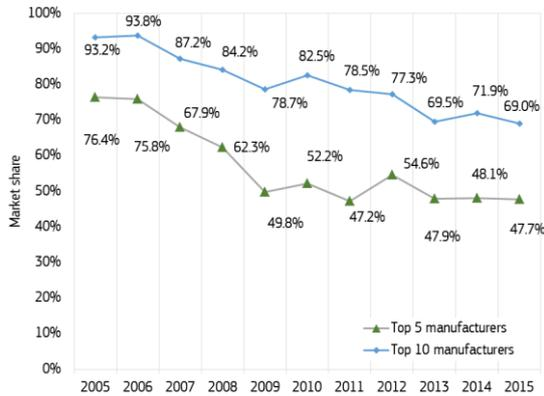

Figure 5 Evolution of turbine manufacture market concentration 2005–2015
Source: BTM Consult (up to 2014) and JRC for 2015

The market share of the Top 10 OEMs declined in a more continuous and stable way from about 93 % in 2005 to 69 % in 2015.

Listed companies are in relatively good financial health with EBIT-margins of about 8 % to 10 % in the case of Vestas, Goldwind, Senvion and Gamesa. Lower but positive EBIT ratios of about 4 % to 5 % were found for Nordex and Ming Yang in 2015.

2.4 Offshore wind installations market

The development of the offshore wind sector is strongly dependent on project developers, specialised companies for the transport and installation of foundations as well as owners of turbine installation vessels. In 2015, the market leader in the development of offshore wind projects was Dong followed by RWE and E.ON. When looking at projects in the pipeline and being commissioned until 2020 the share of projects being developed by utilities even in-

creases compared to those developed by pure developers or independent power producers (IPP) (Figure 6).

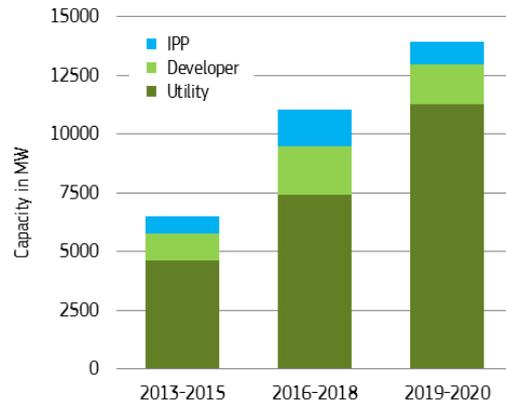

Figure 6 Developers market for projects commissioned or expected to be commissioned in 2013-2015, 2016-2018 and 2019-2020
Source: JRC analysis

The global market of foundation installation vessels in the period 2013 – 2015 was headed by GeoSea, MPI Offshore and Van Oord accounting for 44 % (Figure 7). Future wind farms commissioned for the period 2016 – 2018 indicate an increase in market concentration as the Top 3 companies will accumulate 63 % of the market (Figure 8).

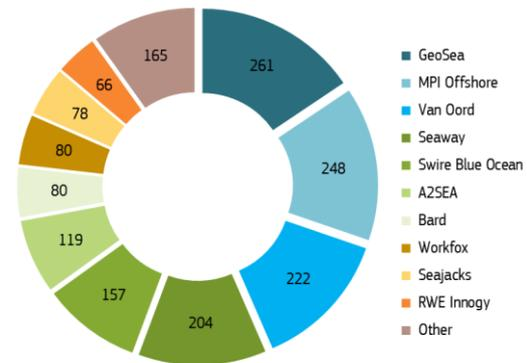

Figure 7 Foundations installation market 2013-2015. Number of installations per company.
Source: JRC

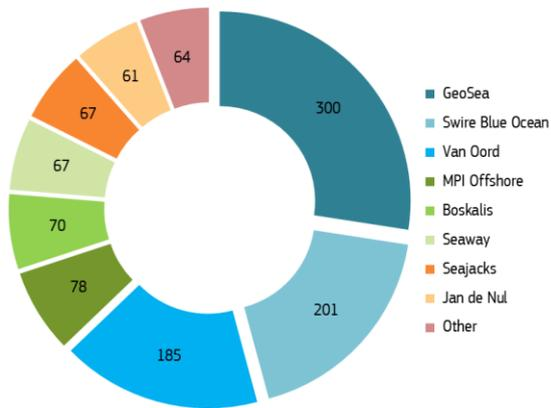

Figure 8 Foundations installation market 2016-2018. Number of installations per company. Source: JRC

A similar conclusion can be drawn from the market status for turbine installation companies in terms of market concentration although with a different trend. From 2013 to 2015 three companies (A2SEA, MPI Offshore and Fred Olsen) installed 75 % of the turbines whereas a much lower concentration of 52 % is expected until 2018.

3 Technology status and development

3.1 Onshore wind energy

3.1.1 Rated power

Most of onshore wind turbines currently installed in the world range from 1 MW to 3 MW (Figure 9). There is an evolution to uprated designs: wind turbines for less than 1 MW have progressively lost ground in favour of 2.5–3.5 MW designs. Consequently, the global average nominal power has evolved from about 1.5 MW in 2006 to 2 MW in 2015 representing a 36 % increase.

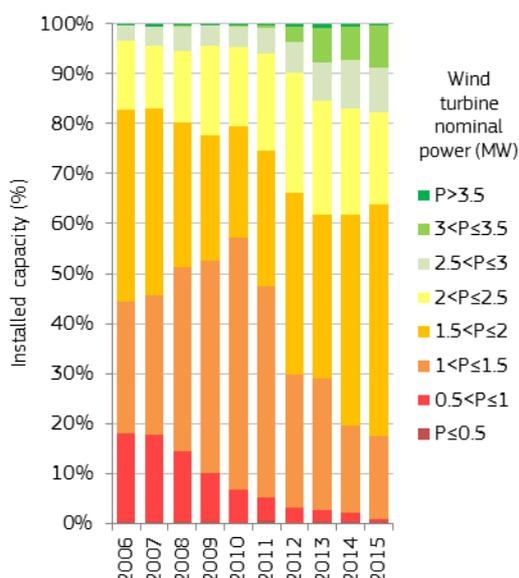

Figure 9 Evolution of nominal power of onshore wind turbines in the world
Source: JRC Wind Energy Database

By geographical region, the European market has historically displayed the highest average rated power representing 1.7 MW in 2006 and reaching 2.4 MW in 2015. However, Asia has experienced the highest increase with more than 70 % from 1.1 MW in 2006 to 1.8 MW in 2015.

The largest onshore wind turbine installed in 2006 had 6 MW while it reached 8 MW in 2015. Nevertheless, the role of wind turbines above 5 MW in the onshore market

is still marginal, representing around 0.3 % of total installed capacity in the world during 2015.

3.1.2 Project size

The small onshore wind projects (≤ 5 MW) showed a decreasing share until 2012 mainly in favour of projects higher than 45 MW. However, the role of small projects has become more significant in recent years. Consequently, the global average project size progressively increased to 30.9 MW in 2012 and decreased by almost 45 % since then (Figure 10).

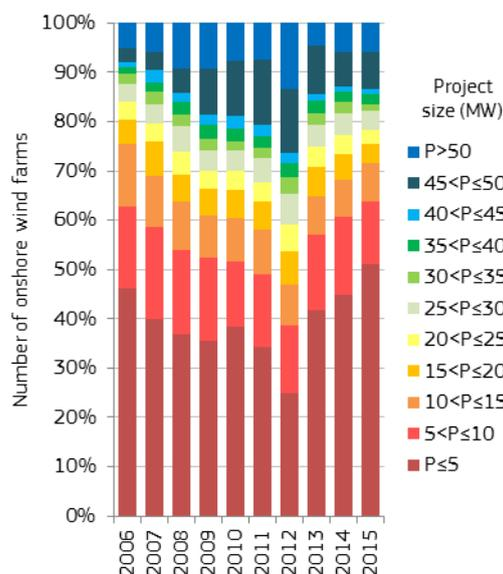

Figure 10 Evolution of onshore project size in the world
Source: JRC Wind Energy Database

By geographical region, North America has historically shown the highest average project size with an increasing trend from 45 MW in 2006 to almost 70 MW in 2015. On the contrary, European market displays the lowest average project size over the years with a decreasing trend from about 12 MW in 2006 to 6 MW in 2015.

3.1.3 Wind class and specific power

Each wind turbine model is designed for particular wind conditions. The IEC 61400-1 standard defines wind classes based on wind speed (further information in Appendix B). In principle, the classes I to III refer to wind turbines aimed to high, medium and low wind speed locations, respectively.

In the global market, wind turbines for high wind speed locations (class I) have progressively lost share in the recent years in favour of wind turbines for medium and low wind speed locations (class II and class III) (Figure 11).

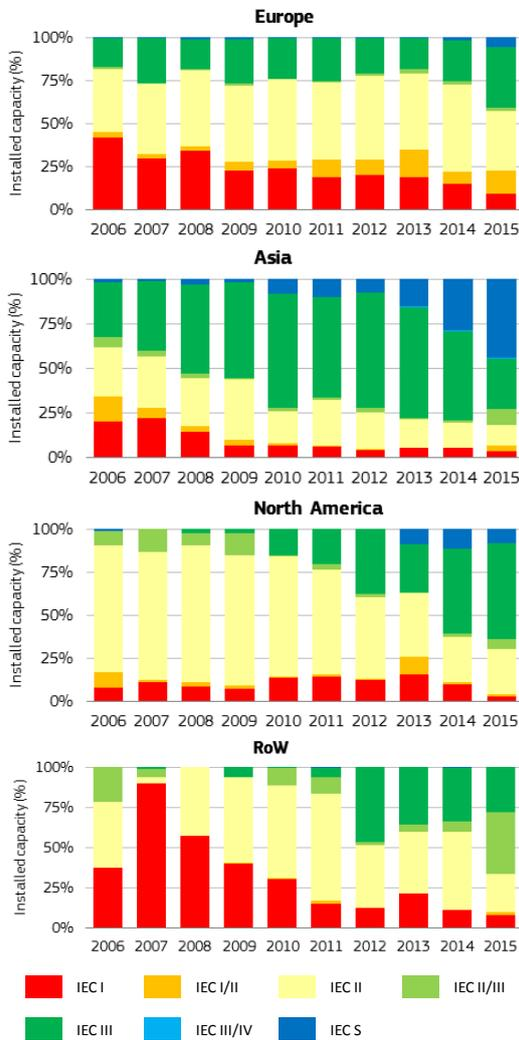

Figure 11 Evolution of the share of installed capacity by wind class in onshore wind turbines by geographical zone

Source: JRC Wind Energy Database

Note: The countries included in each geographical zone are collected in Appendix A.

The Asian market has been dominated by class III wind turbines during the last decade mainly due to the low-wind conditions in most of China and India.

Class II wind turbines (for medium wind speeds) predominated in North America over the years; however low wind turbines (class III) have shown a strong development starting from 2010. In the rest of the world, class I and II wind turbines prevailed. On the contrary, high wind turbines have gradually lost share in favour of class II and III wind turbines. The reason may be that higher wind speed locations were preferred during the first years.

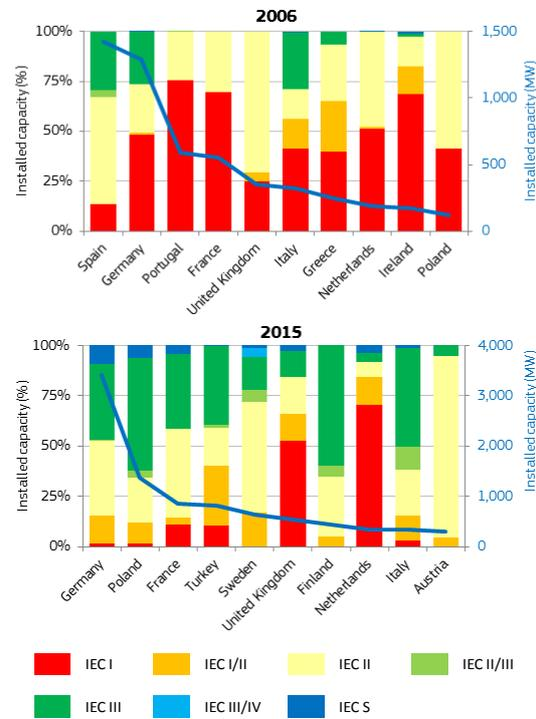

Figure 12 Comparison of wind class in onshore wind turbines of the Top 10 European countries in terms of installed capacity in 2006 vs 2015

Source: JRC Wind Energy Database

In Europe, the trend to low wind turbines is less pronounced because it is highly dependent on the country-specific wind conditions. As shown in Figure 12, Germany, Poland and France (which represented more than 50 % of total installed capacity in Europe in 2015) mainly installed low and medium wind turbines. This may be explained by a reduced availability of high wind speed sites or country-specific measures such as the German support

scheme that promotes new installations in low wind speed locations. On the contrary, high and medium wind turbines predominated in these markets in 2006.

By contrast, onshore markets with good wind resource such as the United Kingdom and the Netherlands continue to install high wind turbines.

The increasing market penetration of class II and III wind turbines is consistent with the trend towards lower specific power (Figure 13). Wind turbines aimed at low-wind speed sites are equipped with larger and more slender rotors and a moderate rated power balancing higher electricity output with higher CapEx.

Asia reached lowest average specific power in 2015 (246 W/m²) and displayed the sharpest decline (36 %) between 2006 and 2015. The European market shows a less pronounced decreasing trend with only 17 %. Nevertheless, the wider diversity of wind resource among European countries has led to higher differences between minimum and maximum values of specific power.

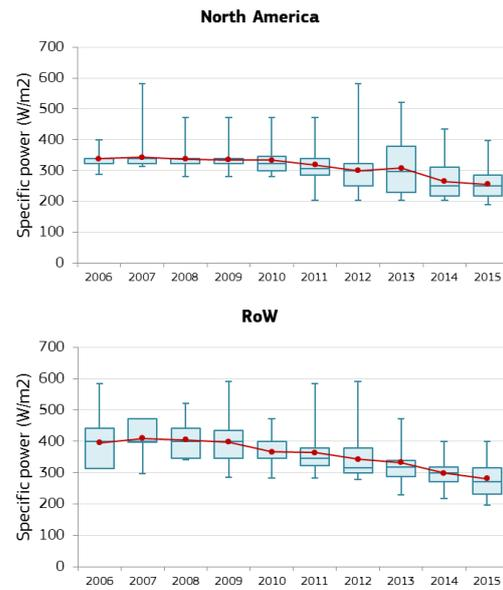
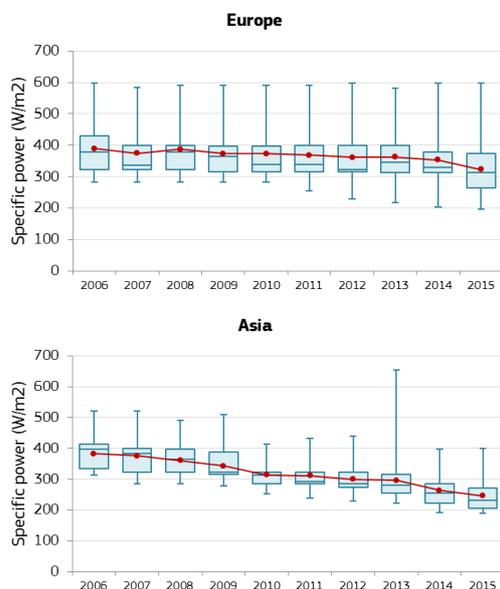

Figure 13 Evolution of the specific power in onshore wind turbines by geographical zone

Source: JRC Wind Energy Database

Note: Wind turbines with nominal power lower than 0.2 MW, rotor diameter lower than 20 m or hub height lower than 30 m are not included in the analysis.

In all boxplot figures, bottom and top sides of rectangles refer to the 25th and 75th percentiles respectively. Bottom and top caps of error bars refer to 1st and 99th percentiles.



3.1.4 Blades

All markets display a strong tendency towards longer blades (Figure 14). In the period 2006-2015, the average rotor diameter of new installations in the world has continuously grown from about 70 m in 2006 (equivalent to a swept area of about 3 780 m²) to about 100 m in 2015 (7 900 m²). This represents an increase of 45 % of average rotor diameter in the last decade and, more importantly, from the point of view of energy capture, double swept rotor area.

In 2015, the largest rotors were installed in North America and Asia (both 101 m average) followed by Europe (99 m) and the rest of the world (98 m). North America has averaged larger rotor diameters over the years compared to other markets mainly because the predominance of medium wind speed locations (as previously shown in section 3.1.3).

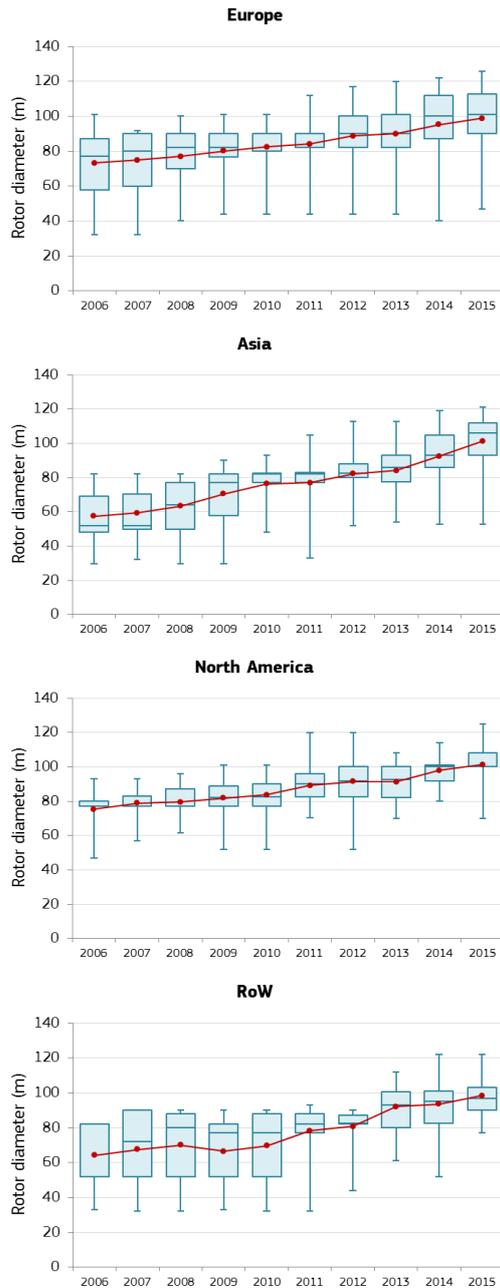

Figure 14 Evolution of the rotor diameter in onshore wind turbines by geographical zone
Source: JRC Wind Energy Database

In addition, average rotor diameters in Asia were significantly smaller than in Europe and North America during the 2000s; however the increasing market penetration of low wind turbines (as previously shown in section 3.1.3) has led to the strongest upward trend in rotor diameter with 77 % in the period 2006–2015.

As with wind class, the wider diversity of wind resource in Europe and the rest of the

world has led to more diverse rotor diameters (higher differences between percentiles).

Regarding average rotor diameters in Europe, Finland is the country with the largest rotors installed in the period 2006–2015 (120 m), followed by Denmark (97 m), Austria (94 m), Sweden (93 m) and Poland (92 m). In 2015 the largest rotors were installed in the United Kingdom (167 m) and Denmark (164 m) to test onshore the Mitsubishi MWT167H/7.0 and the MHI Vestas V164-8.0 wind turbines before their offshore installation.

3.1.5 Towers

The tendency towards larger rotor diameters and wind turbines aimed for low wind speed locations (where wind speed further increases with height) has led to taller towers. The steadier trend observed from 2013 is explained by a smaller sample considered in the analysis. During the period 2006–2015, the worldwide average hub height increased by 9 % from 78 m to 85 m (Figure 15).

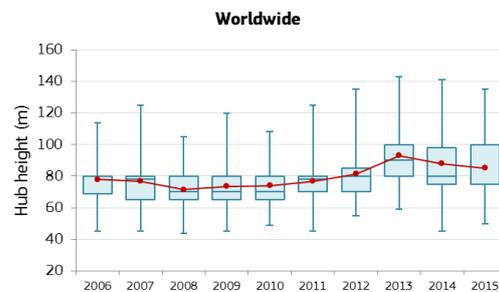

Figure 15 Evolution of hub height in onshore wind turbines
Source: JRC Wind Energy Database

Note: As shown in Table 4, Appendix A, the quality of the sample to analyse hub height is limited so results displayed in the figure may differ from the real hub height evolution.

3.1.6 Drive train configuration

Wind turbines can be classified depending on the drive train components: gearbox (geared or gearless), electric generator (synchronous or asynchronous) and power

converter (partial, full or none). The different types of drive train configurations showed in Table 1 are a redefinition of the classification provided by Hansen et al. [14] (further information in Appendix C, [15] and [16]).

Table 1 Types of drive train configurations

Type	Features
A	Geared and high-speed SCIG (Squirrel Cage Induction Generator)
B	Geared and high-speed WRIG (Wound-Rotor Induction Generator)
C	Geared and high-speed DFIG (Doubly-Fed Induction Generator)
D	Direct drive configuration and low-speed PMSG (Permanent Magnet Synchronous Generator) or EESG (Electrically Excited Synchronous Generator) with full power converter. Type D.PM has PMSG and Type D.EE has EESG
E	Geared and medium/high-speed PMSG (Type E.PM) or EESG (Type E.EE) with full power converter
F	Geared and high-speed SCIG with full power converter

In summary, types A, B and C correspond to geared high-speed wind turbines, type D is direct drive configuration and types E and F represent hybrid arrangements.

The onshore wind market is mainly dominated by type C configuration and to a lesser extent type D, especially in Europe and Asia (Figure 16). Hybrid arrangements have progressively gained ground in the last years although in a different way among geographical zones. We can observe more type E configurations in Europe and type F configurations in North America. Configurations of types A and B have steadily decreased and they currently represent a marginal market share.

Most of type D and type E configurations in the Asian market use PMSGs while EESGs are more common in Europe.

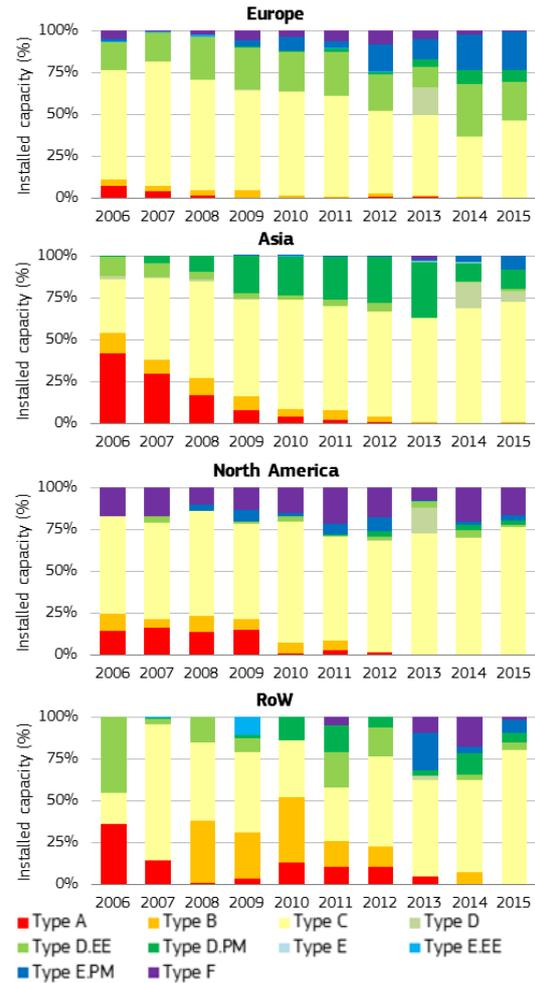

Figure 16 Evolution of the share of installed capacity by drive train configuration in onshore wind turbines by geographical zone

Source: JRC Wind Energy Database

Note: In Type D and E, the type of generator PMSG or EESG has not been identified.

The drive train configuration is closely related to nominal power of wind turbines (Figure 17). Most wind turbines below 2 MW use type C configuration however DFIG loses market share as nominal power increases.

In 2-3 MW wind turbines, direct drive configuration had a similar share than type C in the European market (45 %) in 2015 and it was mainly supplied by Enercon. In turn, type D configuration was mainly dominated by EESGs versus PMSGs, representing 35 % and 10 % respectively. The hybrid arrangements type E-PM and type F only represented 8 % and 1 %, respectively. Conversely, type F configuration displayed the most prominent role in North America

in 2015 and overcame type C configuration by representing 51 % versus 32 %. Siemens supplied all turbines of the type F segment. Unlike Europe, Type D only represented 11 % in North America.

In wind turbines above 3 MW, the hybrid arrangement Type E-PM was the preferred solution in all markets in 2015. It covered the whole market share in Asia, North America and the rest of the world and it represented 60 % in Europe.

Vestas, the leading manufacturer of total onshore wind turbines installed, has historically supplied geared designs, mainly type C configuration. Nevertheless, in 2015 it covered 75 % of type E-PM and 23 % of type C configuration. General Electric supplies similar configurations although it led type C in 2015 representing 28 % of this configuration.

Enercon has historically covered almost the entire supply of EESGs for direct drive configuration while hybrid arrangement type F is exclusively supplied by Siemens. Goldwind's technology is mainly based on PMSGs for type D configuration.

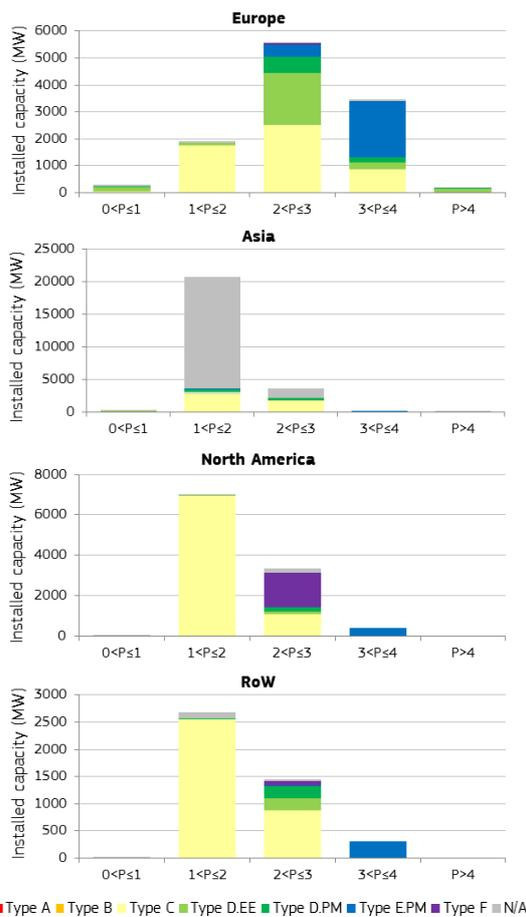

Figure 17 Drive train configuration according to nominal power in onshore wind turbines installed during 2015 and different geographical zones
 Source: JRC Wind Energy Database
 Note: P represents the wind turbine nominal power (MW)

Moreover, manufacturers vary across drive train configurations, as not each OEM offers the entire range of drive train configurations. The Top 10 OEMs in the global onshore wind market show some technological differences in their product portfolio (Figure 18).

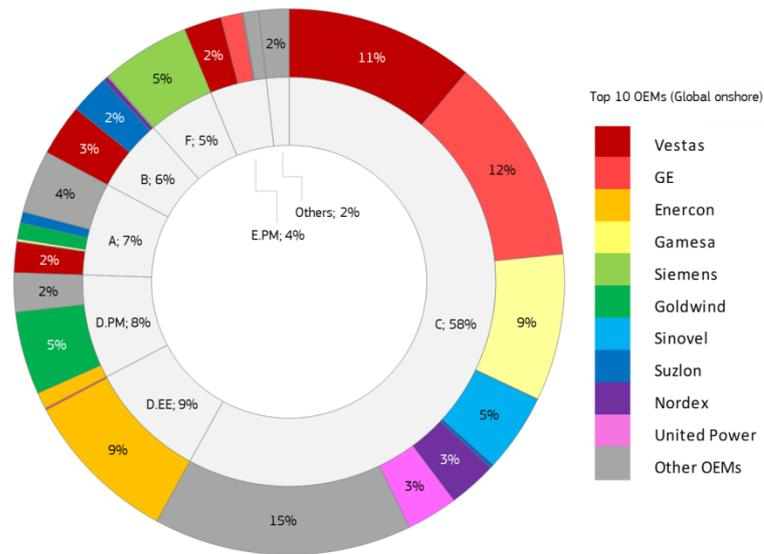

Figure 18 Drive train configuration across the Top 10 OEMs in terms of total installed capacity of onshore wind energy in the world

Source: JRC Wind Energy Database

Note: Inner doughnut represents the share of each drive train configuration in the global onshore wind market while outer doughnut displays the share of the Top 10 OEMs according to each drive train configuration.

The capacity installed with unknown drive train configuration in the JRC Wind Energy Database is not included in the figure.

Type D and E configurations without subcategorization according to type of electrical generator (i.e. either EE or PM) are included in the category of drive train configuration named "Others".

Please note that only the Top 10 OEMs (in terms of global cumulative installed capacity) are represented in the figure. Thus, other OEMs that represent a higher share in some specific drive train configurations are displayed in the category "Other OEMs".

3.2 Offshore wind energy

3.2.1 Rated power

Currently, 2.5-5.5 MW wind turbines are commonly installed in offshore wind projects (Figure 19). The average nominal power has grown from almost 3 MW in 2006 to 3.6 MW in 2015 representing an increase of 20 %. Unlike onshore, the evolution of nominal power of offshore wind turbines is less homogeneous because the offshore market is much smaller and it is dominated by a few wind turbine models.

The largest machine was installed in 2014 in the United Kingdom in the Levenmouth demonstrator turbine with 7 MW (SHI 7.0-171).

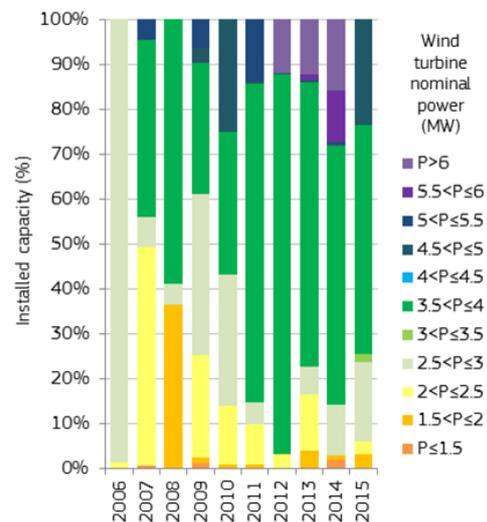

Figure 19 Evolution of nominal power of offshore wind turbines in the world

Source: JRC Wind Energy Database

3.2.2 Project size

As nominal power, the evolution of project size is not uniform. Nevertheless, the number of larger projects has increased in the

recent years and currently offshore projects larger than 100 MW are commonly installed (Figure 20). The average project size in Europe is much higher than in Asia and it has more than doubled from 67 MW in 2006 to 212 MW in 2015.

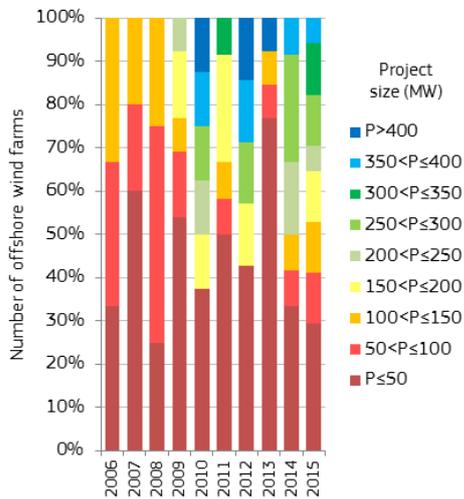

Figure 20 Evolution of offshore project size in the world
Source: JRC Wind Energy Database

3.2.3 Specific power

Offshore wind turbines generally have a higher specific power than onshore designs. Nevertheless, as in the case of onshore wind energy, the average specific power has progressively decreased by 25 % from 470 W/m² in 2006 to about 340 W/m² in 2015 (Figure 21).

This trend is expected to continue over the coming years since most recent wind turbine models introduced (or under development) in the offshore market have increasingly lower specific power.

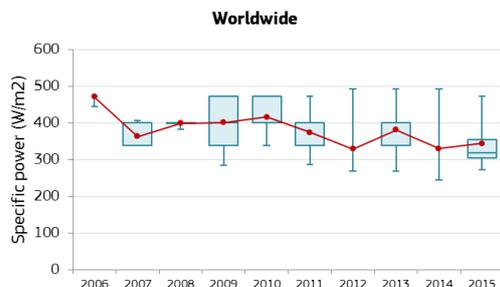

Figure 21 Evolution of the specific power in offshore wind turbines in the world
Source: JRC Wind Energy Database

3.2.4 Blades

In the offshore wind market, the upward trend towards longer blades is less pronounced than in the onshore market and it has remained relatively constant since 2012 (Figure 22). The average rotor diameter grew by 27 % from 90 m in 2006 to 115 m in 2014 (rotor diameter increased by 45 % for onshore wind turbines during the same period). As a consequence, the swept rotor area has increased 1.6 times in the period 2006–2015.

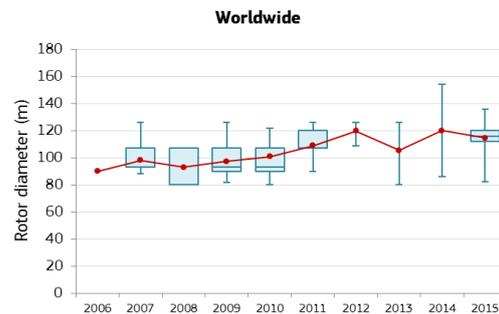

Figure 22 Evolution of the rotor diameter in offshore wind turbines in the world
Source: JRC Wind Energy Database

3.2.5 Towers

In general, towers of offshore wind turbines are smaller than onshore towers and the evolution of the hub height is closely related to rotor diameter. Hub heights increased only until 2013 and they have remained relatively constant since then. Between 2006 and 2015, the average hub height increased by 20 % from 72 m to 87 m (Figure 23).

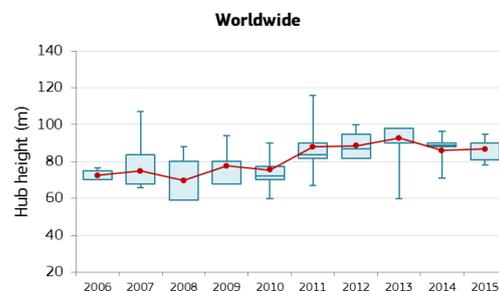

Figure 23 Evolution of the hub height in offshore wind turbines in the world
Source: JRC Wind Energy Database

3.2.6 Drive train configuration

The offshore wind market has evolved from a dominant type C configuration (geared high-speed DFIG) towards both direct drive (type D) and hybrid arrangements (types E and F).

In the European market, the hybrid configurations type F and type E-PM have reached a prominent role in recent years. On the contrary, in Asia, type C configuration is mainly losing ground in favour of type D-PM although this evolution is not homogenous (Figure 24).

The three biggest OEMs, Siemens, MHI Vestas and Senvion dominate the global offshore wind market accounting 85 % of cumulative installed capacity by the end of 2015 (Figure 25). Siemens leads all main drive train configurations used in the offshore market and covers all supplies of the hybrid arrangement type F (as in onshore wind market).

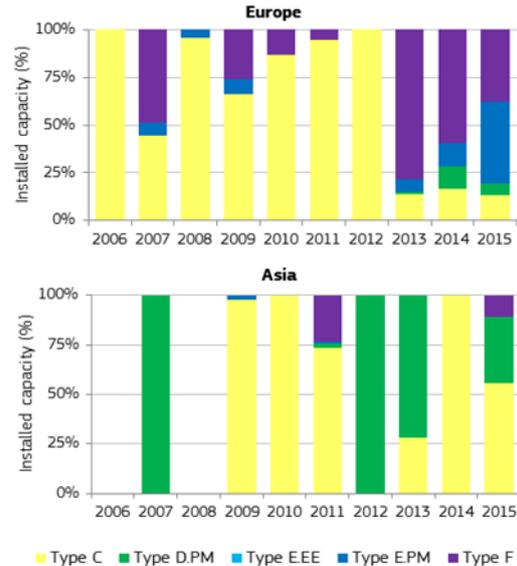

Figure 24 Evolution of the share of installed capacity by drive train configuration in offshore wind turbines by geographical zone
Source: JRC Wind Energy Database
Note: According to JRC analysis, Siemens modified type C (DFIG) drive train configuration of some wind turbines models to type F.

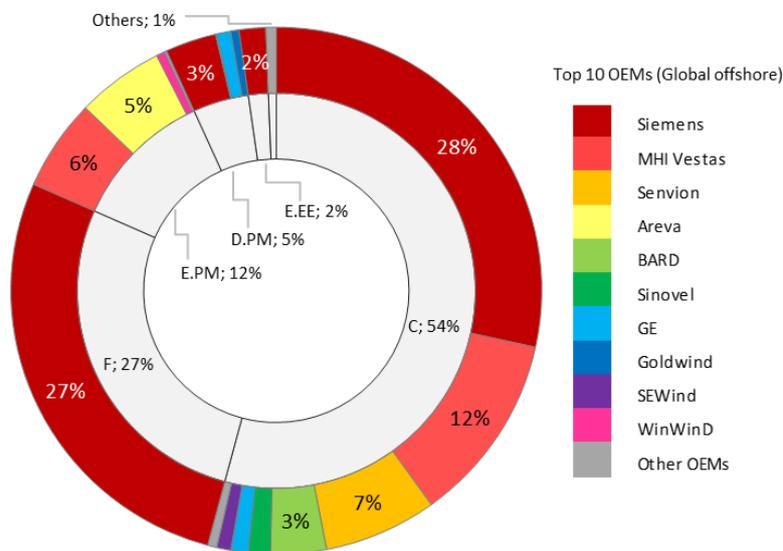

Figure 25 Drive train configuration across the Top 10 OEMs in terms of total installed capacity of offshore wind energy in the world
Source: JRC Wind Energy Database
Note: Inner doughnut represents the share of each drive train configuration in the global offshore wind market while outer doughnut displays the share of the Top 10 OEMs according to each drive train configuration. The capacity installed with unknown drive train configuration in the JRC Wind Energy Database is not included in the figure.

3.2.7 Foundations

Offshore wind projects evolve towards longer distances from shore, deeper waters and larger project sizes (Figure 26). This trend widely influences the evolution of types of foundations. Monopiles are the most commonly used fixed-grounded foundations installed in offshore wind projects representing around 70 % of global installed capacity at the end of 2015. They are followed to a lesser extent by jacket (7 %) and gravity base foundations (5.5 %) (Figure 27).

By geographical zone, monopiles also have a prominent role in European projects fully commissioned and under development. Conversely, Asian market is dominated by other fixed-grounded foundation concepts,

especially of type high-rise pile cap (a type of foundation used in shallow waters under 20 m and mostly utilized in offshore wind farms in China).

Fixed-grounded foundations

Monopiles have a predominant role in 3-4 MW offshore wind turbines, even for relatively deep waters (up to around 35 m). Gravity base foundations are most commonly used in 2-2.3 MW wind turbines and shallow waters (below 15 m depth) (Figure 28).

More diverse foundations are employed for larger wind turbines as well as intermediate and deep water depths, including jackets, tripods and tripiles.

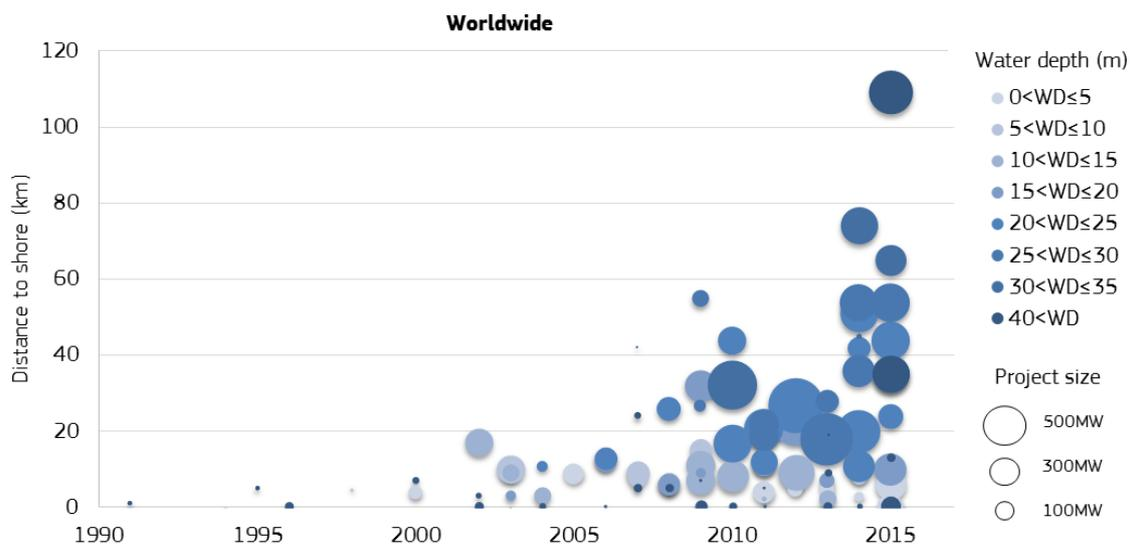

Figure 26 Evolution of global offshore wind projects according to their project size, distance to shore and water depth.

Source: JRC Wind Energy Database

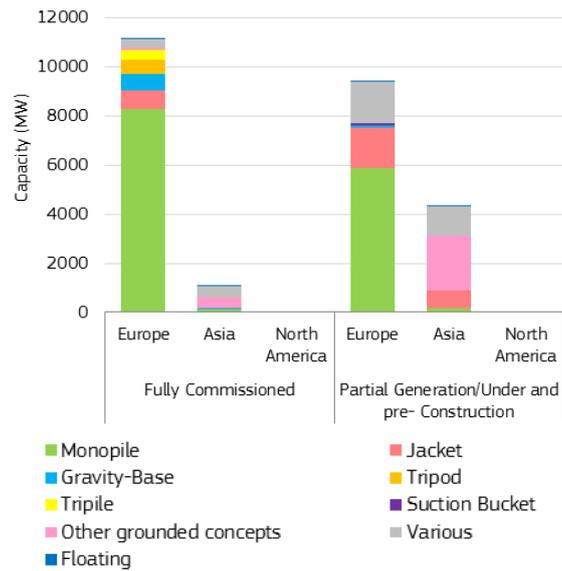

Figure 27 Type of foundations in offshore wind projects (by the end of 2015)

Source: JRC Wind Energy Database

Note: The Keuka 125kW Rim Drive/Liquid Air Storage 1:100 scale prototype has been identified as floating offshore project commissioned in North America in 2015. In the legend, "Various" refers to offshore wind projects with more than one type of foundation. In these cases, the foundation has not been identified in JRC Wind Energy Database

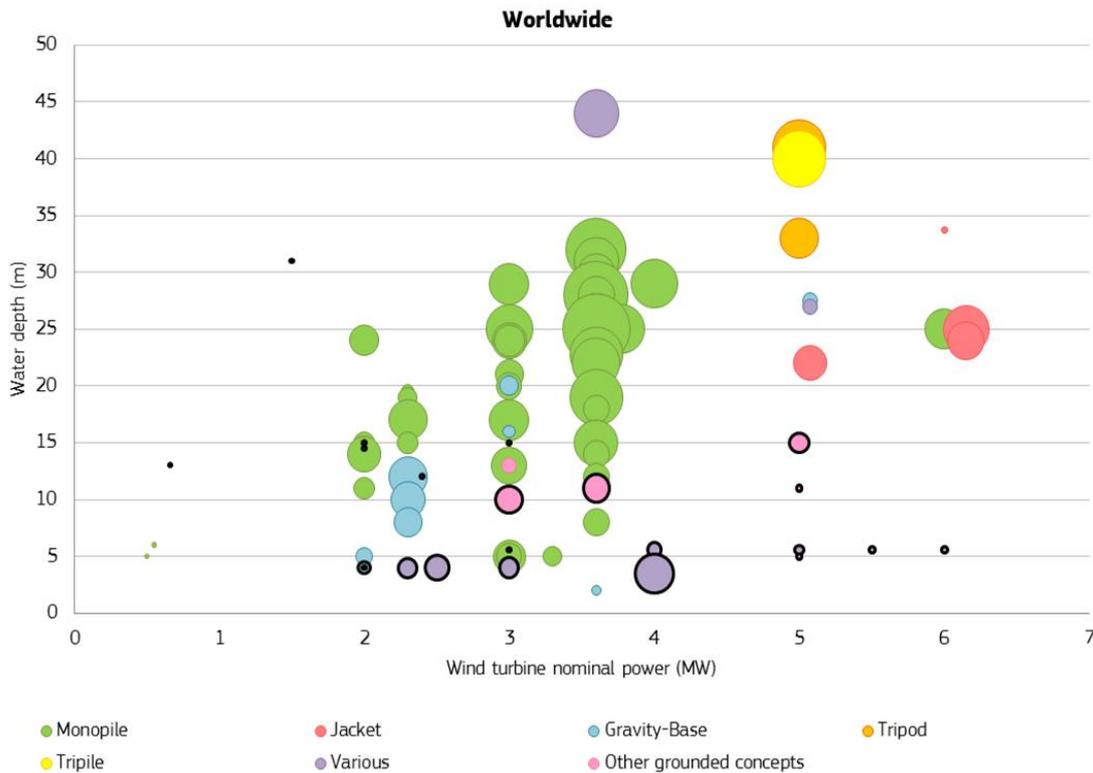

Figure 28 Fixed-grounded foundation types of fully commissioned offshore wind projects in the world by water depth and wind turbine nominal power.

Source: JRC Wind Energy Database

Notes: Bubbles represents European and Asian offshore wind projects. Those with bold border represent Asian offshore wind projects.

In Asia, each bubble does not always represent one offshore wind project because some projects have wind turbines with different nominal power. The figure only includes those projects where water depth is known. Floating projects are not included in the figure.

Floating foundations

An increasing number of countries begin to explore the potential for floating offshore wind technology primarily due to the limited number of areas with shallow waters suitable for fixed-bottom foundations as well as the abundant and constant wind resource in near-shore deep water areas. Floating platforms require a minimum water depth of approximately 40 m although the optimal depth ranges from around 100 m (where the mooring system takes more load and removes some force placed on the anchors) to 150-200 m (in higher water depths, the costs rise as total mass of the moorings increases) [17].

Nowadays, there are six projects fully commissioned in Japan, Norway, Sweden and the USA. However, numerous pilot projects (both prototypes and pre-commercial projects) are planned over the next few years in the USA, Japan, China, South Korea and a significant number of European countries including France, Spain, the United Kingdom, Portugal, Germany, Sweden and Belgium (Figure 29). More than half of projects under development emerge from Europe followed by the USA (29 %) and Asia (15 %). However, in terms of capacity, 84 % of capacity under development is in the USA, followed by Europe (15 %) and Asia (1 %).

Even though there is currently wide heterogeneity of concepts, three floating wind foundation typologies are dominant: spar-buoy, semi-submersible platform and tension leg platform.

The majority of commissioned projects and concepts under development have a semi-submersible platform, likely due to their application in shallow water depths and the lower infrastructural requirements for installation process [17].

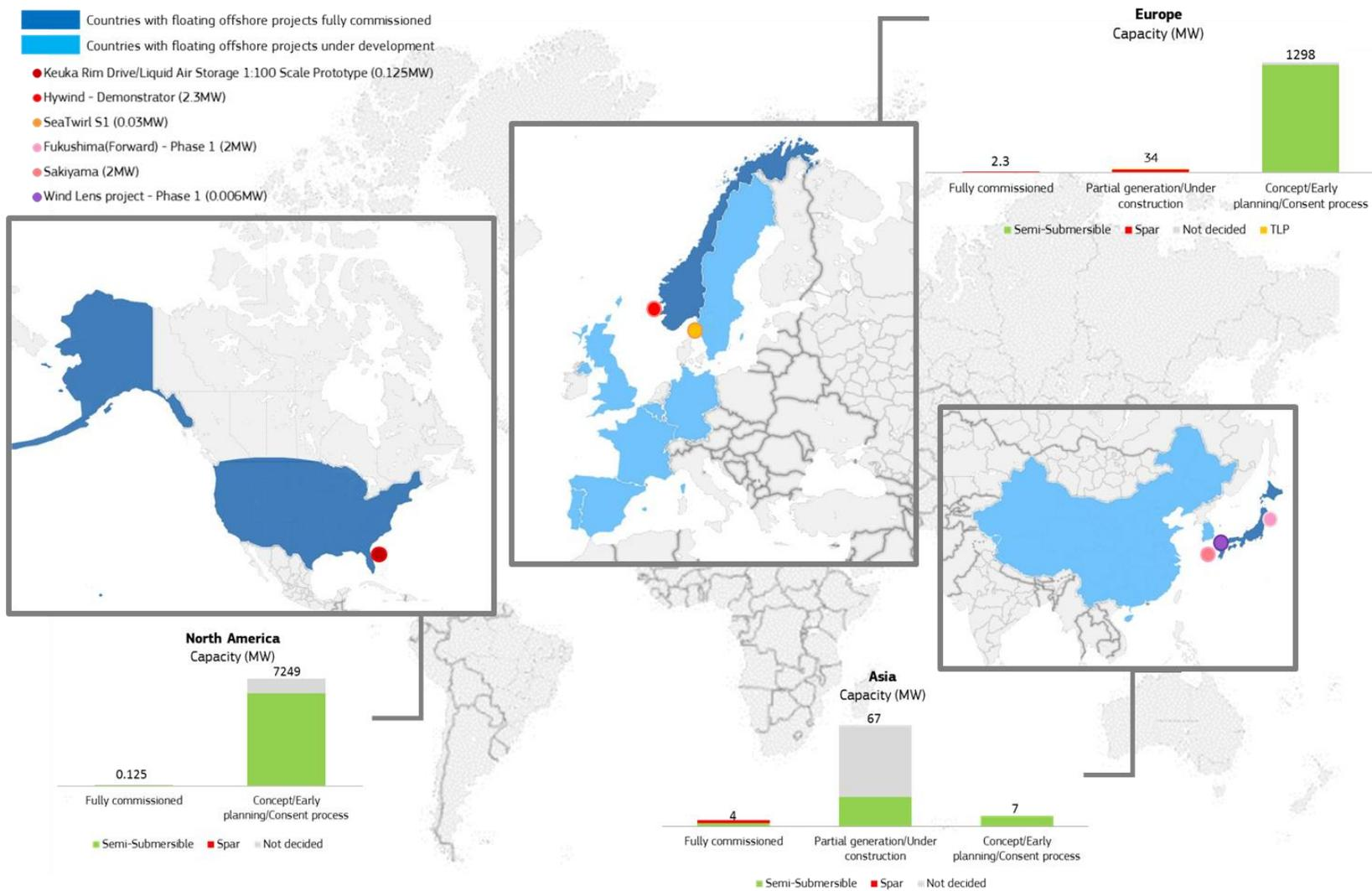

Figure 29 Geographical distribution of floating foundation typologies (December 2016)

Source: JRC

Note: The projects WindFloat-Phase 1 Prototype (located in Portugal), Kabashima (Japan), Sway Prototype (Norway) and VoltornUS Prototype (the United States) were decommissioned before December 2016 therefore they are not included in the figure. The Keuka 125kW Rim Drive/Liquid Air Storage 1:100 scale prototype has been identified as floating offshore project commissioned in North America in 2015.

3.2.8 Electricity infrastructure: offshore transmission system

As with foundations, transmission system in offshore wind projects is widely related with project size and its distance to shore.

Offshore wind projects located near shore (closer than around 10 km) with a moderate project size (less than 100 MW installed capacity) use MVAC connections (lower than 35 kV) to transport the electricity generated to the onshore grid (Figure 30). These voltage levels are provided by individual transformers attached to each wind turbine. Thus no extra platform needs to be installed.

As project size and distance from shore increase, higher voltage levels (mainly 132 kV, 150 kV or 155 kV) are used in order to minimize electrical losses. Very high

voltages (220 kV and 245 kV) have only been used in two projects located less than 40 m from shore.

Nevertheless, the longer distances, higher transmitted power (i.e. more installed capacity) and voltage levels are, the higher the capacitive effect is in AC submarine cables, which generates additional currents and electrical losses. Thus, large projects, which are farther away from shore, use high voltage direct current connection (155 kV HVDC), which requires higher upfront costs. Nine projects located in Germany, which were fully commissioned at the end of 2015, used this type of connection. Currently, the projects Gode Wind 1 and 2, Sandbank, Nordsee One, Veja Mate and Borkum Riffgrund 2 under construction in Germany also plan to use HVDC connection.

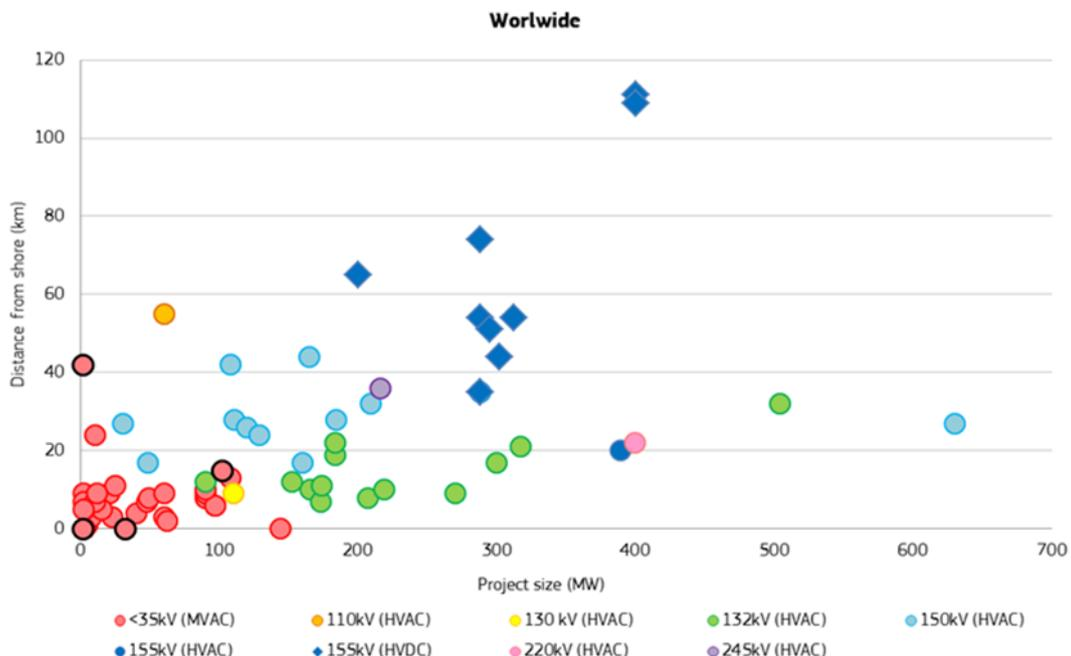

Figure 30 Voltage of submarine transmission connection to onshore grid in worldwide offshore wind projects indicating project size and distance from shore

Source: JRC Wind Energy Database

Notes: Markers represents European and Asian offshore wind projects. Those with bold border represent Asian offshore wind projects.

3.3 Latest technological developments and future deployments

As wind energy technology evolves towards larger wind turbines (longer blades, taller towers and more powerful generators) cutting-edge technology developments and deployments continue to emerge. This section presents both the latest technological developments and the ongoing research activity in key components of wind turbines as well as specific technological features and components of offshore wind farms. Novel wind turbine concepts and technologies are also described.

3.3.1 Key wind turbine components

Blades

As shown in sections 3.1.4 and 3.2.4, the trend towards larger rotors continues. In 2016 Adwen and LMWind presented the longest wind turbine blade that reaches 88.4 m length. It will be tested in the offshore wind turbine model AD 8-180 [18].

Modular designs are a solution for longer blades as they increase flexibility in manufacturing process and reduce transport and logistics constraints. Blades segmented in two sections are currently commercialized by some manufacturers such as Gamesa and Enercon. Most recent deployments aim to achieve modular designs in more sections, such as the prototype BD 78 BLADE (developed by Blade Dynamics) built in 4 sections. The intermediate blade section is flexible in length enabling to manufacture blades of different length [19]. Modular and articulated rotor blades are also been investigated, such as the MoDaR (Morphing Downwind-Aligned Rotor) also known as SUMR (Segmented Ultralight Morphing Rotor). During extreme weather conditions, these blades are able to fold together reducing the risk of damage [20]. This concept is intended to be implemented in blades more than 200 m length for 50 MW off-

shore wind turbines located in areas with harsh climate conditions. At the moment, a small-scale prototype is being developed [21].

Variable tip lengths and different blade tips are other solution for longer blades. LM Wind Power currently leads several research projects on this regard: Hyller project (2014/4 - 2018/3) and InnoTip (2015/1 - 2017/6).

Latest technological developments also aim to improve aerodynamic efficiency of blades to maximize the electricity generation. Some solutions already commercialized are vortex generators (used by Senvion, Vestas and Siemens) and gurney flaps (Vestas). Advanced anti- and de-icing systems, currently used by many OEMs, also aim to improve turbine performance in cold climate conditions.

Progress is being made in monitoring blade deflection and deformation. Some enhanced monitoring systems, such as BladeVision developed by SSB Wind Systems, reproduces blade loads and the full wind field over the complete rotor-swept area (instead of at a single point, as typical systems do) in real time [22]. Remote-controlled drones could also become a complementary monitoring system to existing methods, especially for offshore applications. Vestas already uses remote-controlled drones for its blade inspections whereas other manufactures such as General Electric, Siemens or Nordex are considering their use. Nevertheless, some challenges still need to be overcome with respect to maintaining stability during high wind speeds and developing the software required for blade scanning. [23].

Reducing the noise from wind turbine blades continues to get attention. Up to now the most common commercial solutions consisted of adding serrations at the trailing edge of the blades (used by Enercon, Gamesa and Siemens) as well as using control strategies to de-rate wind turbine operation (Gamesa, Nordex, Siemens and Senvion). New concepts are emerging such as the

next generation DinoTail recently developed by Siemens. It consists of equipping trailing edges with a combination of serrations and combs [24].

Towers

As shown in sections 3.1.5 and 3.2.5, towers are evolving towards higher hub heights. The world's tallest onshore wind turbine was installed by Nordex (N131/3300) in 2016 and it consists of a hybrid steel-concrete tower (two steel segments above a 100 m concrete section) which reaches 164 m hub height [25], [26]. At the end of 2016, Dong installed the world's largest offshore wind turbine (MHI Vestas V164-8.0 MW) with 195 m [27].

As hub height increases, the tendency from tubular steel towers to concrete and hybrid steel-concrete towers is stressed and towers with cutting-edge designs emerge. Some of the latest technological developments commercialized include the bolted steel shell tower (used by Siemens and Lagerwey), the space frame tower (developed by General Electric) and the large-diameter steel tower or LDST (proposed by Siemens). The space frame tower and the LDST are among the tallest towers currently in operation with 139 m and 140 m hub height, respectively [25], [26].

New concepts and materials are rising with the purpose of overcoming the challenges related with higher towers. Thus, the Hexcrete tower (designed for 120-140 m hub heights) is made of pre-tensioned concrete columns and rectangular/tapered panels creating a modular design that simplifies and reduces costs for installation, transport and decommissioning processes [28], [29]. It was launched commercially in May 2016 [30]. Other materials such as wood are also being investigated. TimberTower has also developed a wooden tower that reduces costs for fabrication, installation and transport processes compared to concrete and steel [31]. At the moment, a prototype of 100 m hub height has been tested although different designs are planned for 140 m or even 160 m hub heights [32].

Electric generators

Progress is being made to reduce the content of rare earths (in particular dysprosium, the most used, scarcest and costliest rare earth element) in permanent magnets employed in PMSGs. Most recent technological advances aim to go beyond by finding substitute materials to rare earths. In this sense, the world's first ferrite-based PMSG has been developed by GreenSpur Renewables. Unlike rare earths, ferrite has no supply-chain restrictions or market monopolies so a lower CapEx may be achieved, especially relevant for larger electric generators. [33]. Currently, 3 MW and 6 MW ferrite-based PMSGs are being deployed and a 15 MW PMSG is expected to be tested by 2021 [34]. New magnetic alloy alternatives to dysprosium are also being investigated. An alloy of cerium co-doping with cobalt to substitute cerium for dysprosium without losing desired magnetic properties could become an alternative in the future [35].

Superconductor-based generators may come to replace PMSGs. The ongoing research project [EcoSwing](#), funded by the EU Framework Programme for Research and Innovation H2020, aims to achieve the world's first demonstration of a low-cost and lightweight superconductor-based generator in a modern 3.6 MW wind turbine installed in Denmark by 2019. This superconducting generator is expected to achieve a weight saving of more than 40 % compared to conventional generators and to drastically reduce the use of rare earths in permanent magnet generators (from 200 kg/MW to less than 2 kg/MW).

As wind turbines evolve towards more powerful electric generators, modular designs also start emerging with the target of achieving weight reduction and more compact dimensions. In a modular design, the electric generator is constructed in sections reducing costs for transportation and installation processes. Furthermore, if any stator module fails, either it can easily be replaced facilitating the maintenance process or the wind turbine can continue to operate at reduced power output [33]. Modular generators also better satisfy the grid codes [36].

Some generators recently deployed are the modular prototype Flux-Switching PMSG (also known as Permavent) developed by Jacobs Powertec [33] and the modular EESG for the 4.2 MW E-126 wind turbine model developed by Enercon [37].

Gearboxes

New gearbox designs aim to be lighter and more reliable in order to reduce both CapEx and OpEx.

New software solutions to predict how long wind turbine components will last start being commercialized. For example, some wind turbine models of Adwen and General Electric use a software modelling system developed by Sentient Science to indicate what and when is most likely to fail in the gearbox and extend its lifetime [38].

Minimizing loads to the drivetrain components is getting a lot of attention. In this sense, the new concept Geislinger Compowind consists of a flexible coupling installed between the rotor and the gearbox that significantly reduces non-torque loads⁷ and avoids its transmission to all drivetrain components [39]. At the moment, this coupling has been tested and validated in a 6 MW offshore wind turbine [40].

3.3.2 Specific offshore wind turbine components

Fixed-grounded and floating foundations

In offshore fixed-grounded foundations, some innovations aimed to achieve more cost-effective designs have recently emerged. The novel hybrid suction bucket-jacket concept developed by Siemens is built using prefabricated nodes and standard steel pipes [41]. Four prototypes will be tested at the Nissum Bredning offshore wind project in Denmark in May 2017 [42].

Efforts to save costs in construction and installation phases are being taken forward. The ongoing H2020-funded research pro-

jects, DEMOGRAVI3 and Elican aim to reduce LCoE for future projects by constructing and assembling the complete system onshore and removing the use of heavy-lift vessels for transportation. In particular, [DEMOGRAVI3](#) aims to demonstrate an innovative gravity-based foundation in a 2 MW prototype wind turbine installed in Portugal by 2019 as well as achieve a TRL 7 for GRAVI3 technology. It also expects to reduce LCoE by 10-15% for future projects. [Elican](#) will design, build, certify and fully demonstrate an integrated self-installing precast concrete telescopic tower and foundation in a 5MW Adwen wind turbine in the Canary Islands by 2018. It will be the first bottom-fixed offshore wind turbine installed in Southern Europe. The project expects to achieve a CapEx reduction higher than 40% compared to jackets and XXL monopiles for water depths further than 35 m and wind turbines higher than 5 MW.

In floating foundations, R&D efforts are focused on reducing LCoE of different typologies for larger wind turbines. The [LIFESSOPlus](#) project (funded by H2020) aims to prove cost-effective technologies for floating substructures for 10 MW wind turbines and develop a KPI-based methodology for evaluation and qualification process of floating substructures. The project [TELWIND](#) aims to test a pioneering spar floating substructure with self-erecting telescopic tower for wind turbines higher than 10 MW by 2018 and achieve a TRL 5 for this concept.

Grid connection

Latest technological developments consist of modular offshore substations with the aim of reducing weight, simplifying maintenance process and lowering costs. For offshore wind farms located less than 80 km away from the coast, Siemens has developed the OTM (Offshore Transformer Module). This new AC offshore substation has a reduced size that allows its placement on existing foundation of a wind turbine. As a consequence no extra platform is needed. Moreover, multiple modules can also be used for offshore wind farms with larger

⁷ Bending moments transmitted by static and dynamic distortions from the rotor to the gearbox and its bearings.

capacities [43]. Siemens has also developed a smaller and more compact DC substation platform for offshore wind farms placed further 80 km away from the coast [44]. This is an important advance in HVDC technology which is becoming more attractive than traditional HVAC for longer distances from shore and bigger projects (as shown in section 3.2.8).

Technological advances towards 66 kV inter-array cable systems can also be observed. As offshore wind farms become larger, array cables of 66 kV nominal voltage become more attractive than traditional 33 kV cables since they can transport more power thus more wind turbines can be connected to the same cable. The Blyth Offshore Demonstrator Wind Farm Project located in the United Kingdom (currently in pre-construction phase and probably commissioned in 2017) will be the first offshore wind farm to use the new 66 kV array cable technology [45]. In the short term, 66 kV systems are also expected to be used in other large offshore wind projects such as East Anglia ONE (714 MW) in pre-construction phase in the United Kingdom and Borssele I and II (760 MW) whose consent has been authorised in the Netherlands.

3.3.3 New wind turbine concepts

Innovative wind turbine concepts are emerging with the purpose of improving performance, achieving more cost-efficient wind turbines and overcoming challenges resulting from scaling up designs.

Vestas has developed a multirotor turbine which consists of two nacelle operational levels with two rotors in each and a cylindrical tower section in between. This concept aims to reduce the LCoE by building a more cost-efficient wind turbine and increasing its energy output [46]. A 900 kW multi-rotor turbine demonstrator was installed in Denmark in 2016 to test the technical and commercial feasibility of the concept [47].

General Electric has recently developed the EcoROTR (Energy Capture Optimization by

Revolutionary Onboard Turbine Reshape), a large dome-shaped object added over the rotor. This new concept pushes wind on the blades increasing the performance. It could allow to install shorter blades in the largest wind turbines reducing construction costs and minimizing transportation and logistics constraints [48]. At this stage, the experimental EcoROTR has been installed in a 1.7 MW prototype wind turbine [49].

3.4 Scientific publications and participation in EU granted projects in key wind turbine components

The research activity in the main wind turbine components is assessed in this report by analysing documents and contributions to R&D activity (scientific publications and participations in EU projects). The results are displayed for different geographical zones, sectors and institutions with the aim to determine the main players in wind energy components.

This evaluation covers the period 2011-2015 and makes use of the JRC's Tools for Innovation Monitoring (TIM) software. TIM was developed by the JRC to monitor the evolution of established or emerging technologies (see further information in Appendix D). TIM identifies the entities involved and can visualise collaboration patterns by counting activity levels in documents (scientific publications, patents and EU projects). However, it does not evaluate the quality of the documents.

As the most recent years are the interest of this report, patents were excluded from the analysis as they are published with a lag of 3 years after they were filed by the company/institution. Nevertheless, if the last year of complete patent data is assessed, the share of patents in overall contributions accounts for 40 % (Figure 31).

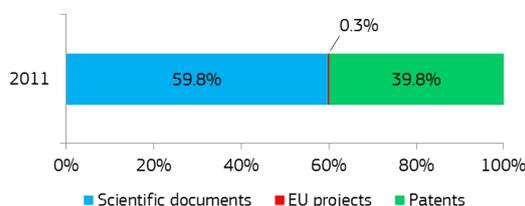

Figure 31 Share of scientific documents, EU granted projects and patents retrieved from TIM on wind turbine components in the year 2011
Source: JRC based on TIM

The analysis focuses on some of the key wind turbine components in which a higher R&D activity may potentially be expected, namely:

- blades
- electric generators
- offshore foundations
- towers
- control systems
- gearboxes
- bearings
- power converters

Nearly 100 % of the R&D documents identified by TIM in the period 2011-2015 are scientific publications, (i.e. articles, conference proceedings, reviews and book chapters) while EU granted projects hardly reach 1 %.

Nearly 35 % of the documents retrieved are in the research area of blades, followed by electric generators (21 %) and offshore foundations (12 %).

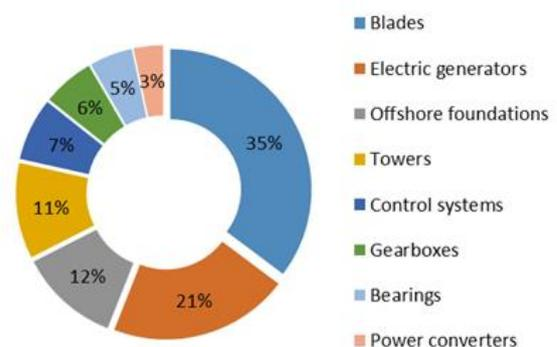

Figure 32 Share of scientific documents and EU granted projects retrieved from TIM on wind turbine components in the period 2011-2015
Source: JRC based on TIM

In the next sections, the scientific documents displayed in Figure 32 are analysed by the number of contributions by geographical zones, sectors and entities.

3.4.1 Scientific publications and participation in EU granted projects by geographical zones

Asia issues the highest number of contributions in wind energy components, leading the share of total contributions in al-

most all the wind turbine components analysed. Particularly, Asia leads with more than 40 % of the contributions identified in the area of blades, towers, control systems, gearboxes and bearings.

Europe is the second main actor leading the contributions to electric generators, offshore foundations and power converters. North America represents around 15 % of the global contributions for each component (Figure 33).

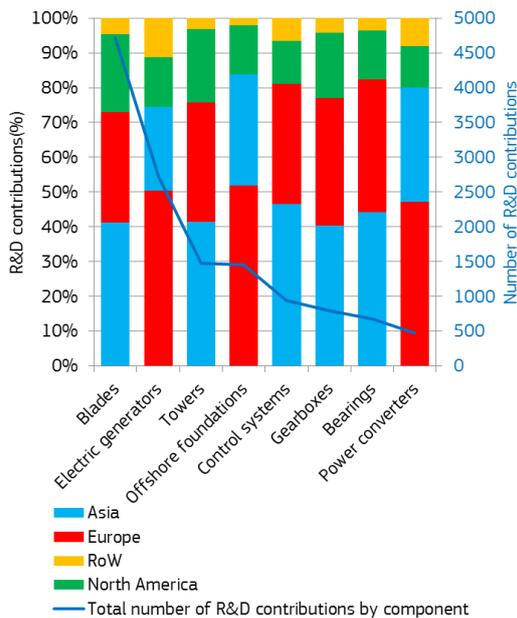

Figure 33 Geographical distribution and number of R&D contributions (publications and participation in EU projects) in wind turbine components⁸

Source: JRC based on TIM

Note: The countries included in each geographical zone are collected in Appendix A.

The Top 10 countries in terms of contributions in the period 2011-2015 are led by China. Across all the Top 10 countries, the highest number of contributions to publications and EU research projects are made in the field of blades (ranging between

⁸ The number of contributions refers to the number of documents published or co-published by a certain country within a geographical zone and not to the contributions of a particular entity. That means, for example, that if three entities from the same country publish a paper together, the document itself counts as just one contribution for that country and therefore for its geographical zone. The mismatch with the number of R&D contributions shown in Figure 36 is also due to the fact that some entities are not attributed to any country because the database (see Appendix D) does not provide that information.

25 % in India and almost 50 % in the United States), except for Norway and India, where offshore foundations (33 %) and electric generators (49 %) occupy the second position, respectively. In general, contributions in the field of towers also show a relevant position within each country (ranging from around 5 % in India to 20 % in Norway) (Figure 34).

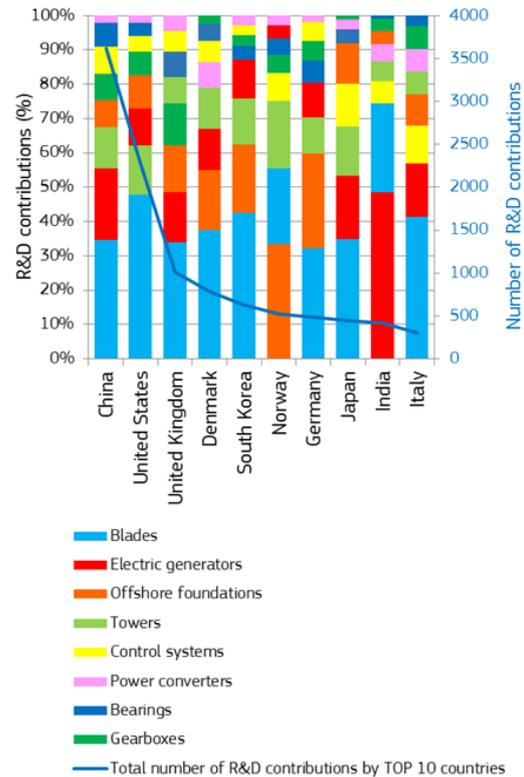

Figure 34 Distribution and number of R&D contributions (publications and participation in EU projects) in wind turbine components by the Top 10 countries

Source: JRC based on TIM

To show the collaboration patterns between countries, two exemplary bibliometric maps for the two components with the highest number of contributions in wind technology in general (blades) and in offshore wind in particular (offshore foundations) are drawn from TIM. Both maps are so called "countrygrams". The node size in Figure 36 is based on the number of contributions retrieved, whereas the thickness of the edges indicate the co-occurrence between two nodes, and thus that the nodes have documents in common. With regard to the searches performed for blades, the strongest collabo-

rations were found between the United States and China (41 collaborations) and between the United States and South Korea (35 collaborations). The Top countries in this component formed the following two clusters:

- The United States-China-South Korea-Japan (dark orange group)
- The United Kingdom-Denmark-Norway (light orange group)

In the case of the offshore foundations component the strongest collaboration can be observed between South Korea and the

United States (14 collaborations) and between the United States and China (13 collaborations). TIM identified for the offshore foundations the following clusters:

- The United States-China-the United Kingdom (orange group)
- Denmark-Norway (dark yellow group)
- South Korea-Japan (light yellow group)
- Germany-the Netherlands (green group)

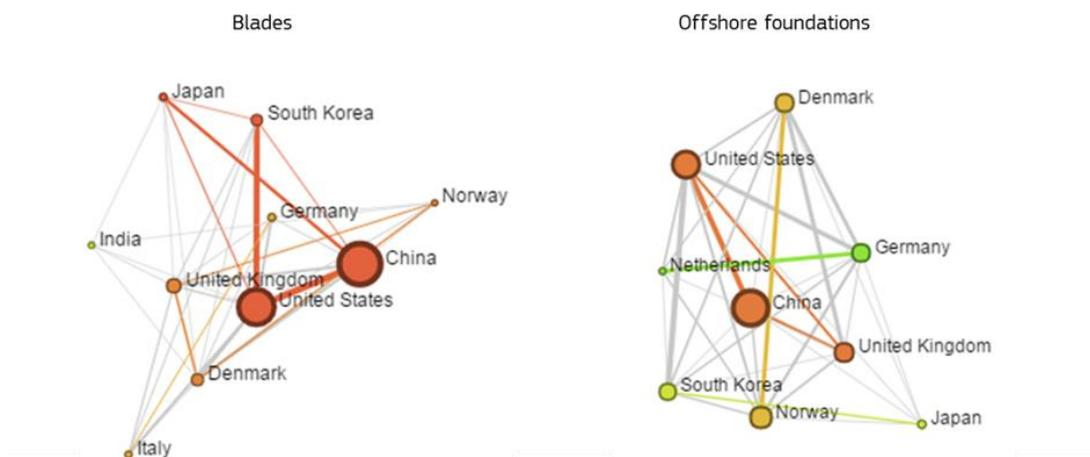

Figure 35 Bibliometric maps (countrygrams) of the main players in R&D contributions (scientific publications and participations in EU granted projects) for blades (LEFT) and offshore foundations (RIGHT)

Source: JRC based on TIM

3.4.2 Scientific publications and participation in EU granted projects by sectors

Most of contributions in all analysed components come from the public sector ranging between 87 % in offshore foundations to 95 % in electric generators (Figure 36).

Among the Top 5 institutions for each component Aalborg University leads the ranking in terms of total number of contributions (19 %). North China Electric Power University and the Technical University of Denmark rank on the second and third position, respectively (Figure 37). The Norwegian University of Science and Technology and Aalborg University represent the

institutions with the more diversified portfolio as they contribute to almost all analysed components. Numerous Chinese public institutions appear in our Top 5 though with a limited number of contributions.

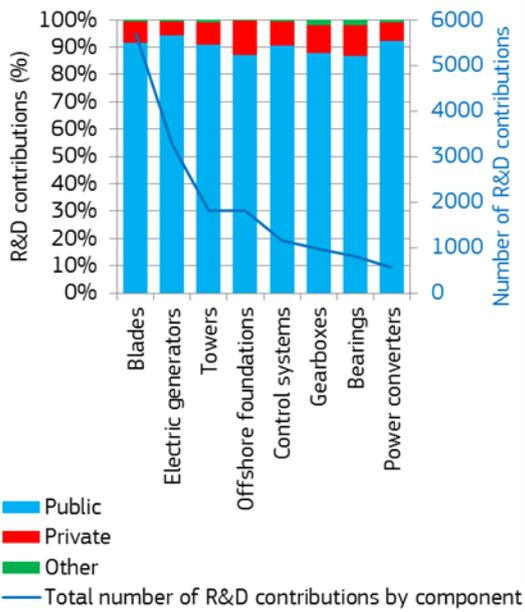

Figure 36 Distribution of R&D contributions (publications and participation in EU granted projects) in wind turbine components
Source: JRC based on TIM

Collaborations between different organisations have also been identified. In general, those collaborations (or shared documents) take place between public institutions. Some of the most relevant collaborations are between the Aalborg University-Technical University of Denmark (9 collaborations) for blades and the cluster Technical University of Denmark-Norwegian University of Science and Technology-Aalborg University for towers, with the strongest contribution of the collaboration between the Technical University of Denmark-Aalborg University (4 collaborations).

However, the results on scientific publications and participation in EU granted projects of the private sector only allow limited insights, as companies mainly use patents to publish and secure their R&D activity

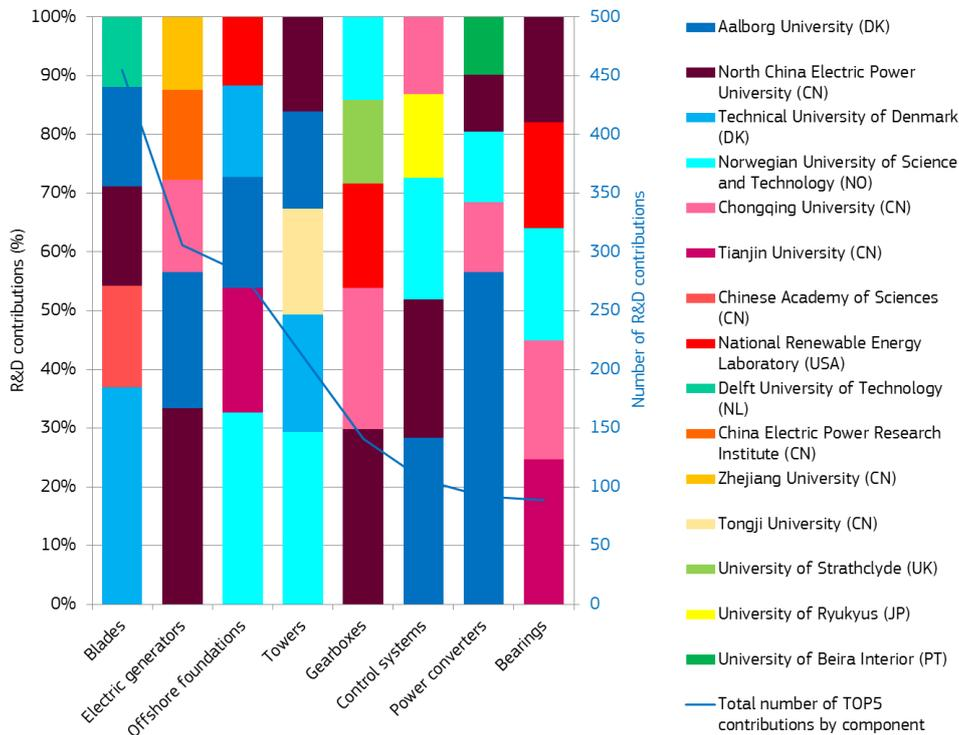

Figure 37 Distribution of R&D contributions (publications and participation in EU projects) across the Top 5 institutions in each wind turbine component
Source: JRC based on TIM

Note: Blue-green colours are associated with European institutions while purple-red-yellow colours refer to non-European institutions

4 EU Horizon 2020 framework programme

The EU Framework Programme for Research and Innovation, known as HORIZON 2020, currently allocates more than EUR 140 million to 60 projects related with wind energy and it covers in most cases between 70-100 % of their total costs.

Figure 38 and Figure 39 aim to classify H2020-funded wind energy projects according to EU funding received, project duration and main research and innovation areas addressed. Figure 38 displays projects coordinated by one European country while Figure 39 shows collaborative projects among institutions from different countries.

Even though each project has specific objectives, some commonalities can be identified among them in terms of main research and innovation areas covered. In this sense, the projects have been classified into the following categories:

- **New turbines, materials and components:** this category covers projects on advanced materials and/or technological innovations in components such as blades, towers and electric generators, among others, as well as new solutions in control and monitoring systems.
- **Resource assessment:** new systems, devices and analysis of wind resource.
- **Offshore technology:** innovations in offshore wind turbine components including fixed-grounded and floating foundations and offshore wind towers.
- **Logistics, assembly and testing:** advanced self-installing structures, more eco-efficient processes and new building methodologies.
- **Grid integration:** new solutions for incorporating increasing amounts of wind energy into the power system.
- **Micro/ Mini wind:** innovations in small wind turbines (10-50 kW)
- **Multidisciplinary:** projects that combine solutions for both wind en-

ergy and other energy technologies, mainly wave and solar energy.

- **Innovative concepts:** airborne wind energy systems and innovative wind turbine designs.
- **Auxiliary Software:** other software than control and monitoring systems.
- **Miscellaneous:** projects focused on training, test/research facilities and data.

New turbines, materials and components concentrate almost 60 % of H2020 contribution, followed by offshore technology (around 40 %) and multidisciplinary projects (more than 15 %)⁹.

Regarding countries involved, 65 % of these projects are coordinated by one European country while 35 % are collaborative projects among institutions from different countries. Nevertheless, these latter receive almost 90 % of H2020 contribution. Spain has the strongest presence participating in more than 40 % of projects (22 % of projects coordinated by one European country and 20 % of joint projects). The United Kingdom ranks the second position accounting for 32 % (8 % and 23 %, respectively). Germany, the Netherlands and Denmark have a high presence in joint projects accounting for 22 %, 20 % and 18 %, respectively.

⁹ These percentages do not sum 100 % because some projects have been classified according to more than one research or innovation area.

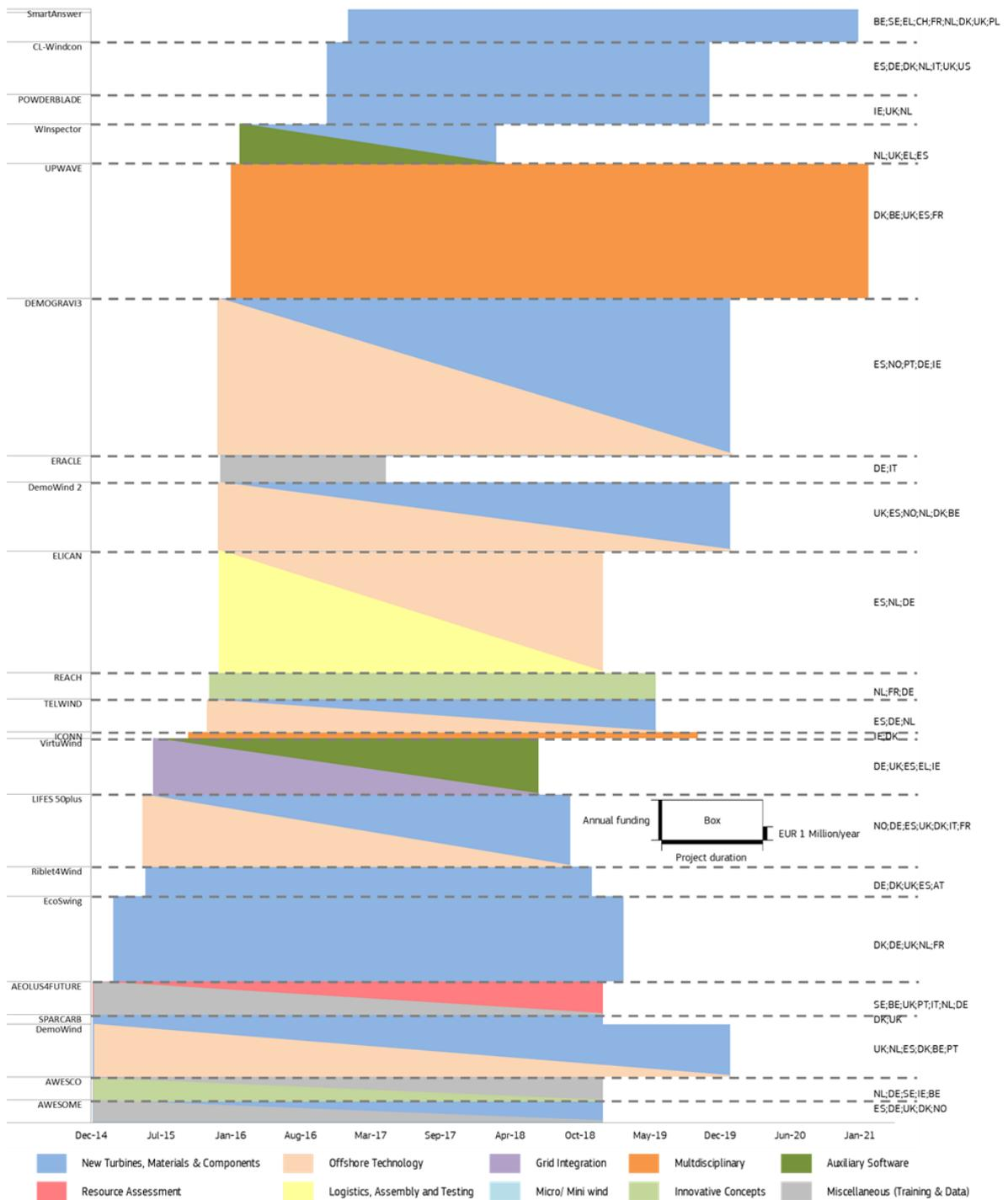

Figure 39 Horizon 2020-funded projects on wind energy participated by different countries and classified according to EU funding received, project duration and main research and innovation areas addressed
Source: JRC based on CORDIS

Note: The total H2020 funding allocated to each project is represented by each box surface. The box height indicates the estimated annual contribution allocated to each project. It was calculated based on the total funding awarded and the years of duration of the project.

The projects that address two research and/or innovation areas are represented by a box divided in two colours. Please note that every area does not necessarily represent 50 % of research topic in the project.

Page intentionally left in blank

5 Regulatory framework in the EU MSs

The State Aid Guidelines for Environmental protection and Energy (EEAG) 2014-2020 encourage EU Member States to change their regulatory framework for wind energy towards schemes that ensure higher market compatibility. Subsidies like feed-in tariffs grant a high level of security to the investors, but market signals are neglected which is the basis for higher shares of wind energy in the energy system. The EEAG 2014-2020 propose that EU MSs replace feed-in tariffs by feed-in premiums from January 2016 and set up a competitive bidding process to grant support to all new installations from January 2017.

The current support schemes applied are varying across EU MSs and a difference can be observed between the support schemes for onshore and offshore wind (Figure 40). The most common support schemes for onshore wind are feed-in tariffs followed by feed-in premiums. In offshore wind energy, new projects are supported by feed-in premiums followed by tradable green certificates. No EU Member State grants any feed-in tariffs determined administratively for the sale of offshore wind energy of new installations.

Competitive tender-based support schemes setting the remuneration to be paid to the plant operators are applied in nine EU MSs for onshore wind and seven EU MSs for offshore wind. However, as of July 2016 only three EU Member States offered a tender-based feed-in premium, namely Croatia (onshore), The Netherlands (on- and offshore) and Denmark (offshore) (further information in Appendix E).

To bring their national support schemes in line with the EEAG 2014-2020, some EU Member States have planned regulatory changes. As of July 2016, Germany and Hungary were in progress to introduce regulatory changes in order to implement a feed-in premium tender-based support scheme, which should become effective by 1 January 2017. New market-based regulatory frameworks replacing feed-in tariffs were under development in Ireland, Slovakia and Finland. Lithuania is developing a new regulation to change their current support scheme for wind energy.

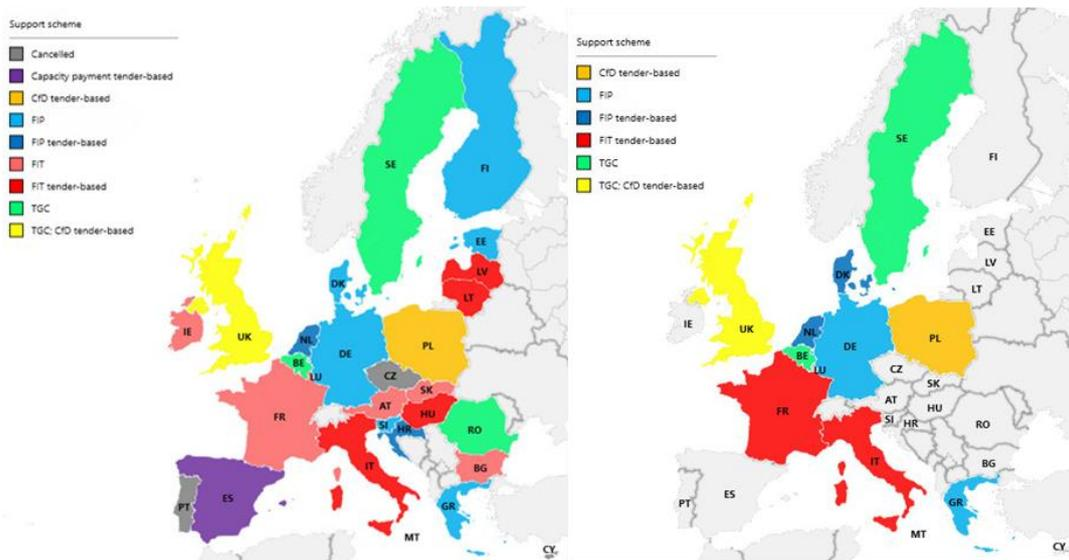

Figure 40 Overview of support schemes for new onshore (LEFT) and offshore (RIGHT) wind energy projects (at utility-scale) in EU Member States (in force in July 2016)

Note: Contract for Difference (CfD); Feed-in Premium (FIP); Feed-in Tariff (FIT); Tradable Green Certificates (TGC).

Source: JRC

Regarding grid issues, most EU Member States apply non-discriminatory connection regime, priority access and priority dispatching to wind energy generators.

The associated grid connection costs are shared differently among producers and grid operators. Most EU MSs implement the shallow cost approach at transmission level, where the plant developer bears the cost to connect the generator to the nearest connection point of the existing grid. Conversely, the deep cost approach requires that the plant developer bears all connection costs and the cost of any grid reinforcement resulting from the integration of the wind farm. At distribution grid level the deep or shallow-deep approach is followed. Additionally, G-charges¹⁰ are implemented for the use of the transmission network in almost half of EU MSs and they are energy-based in most cases.

The compensation of imbalances between generation forecast and the actual electricity feed-in is an obligation in most EU Member States with high wind penetration rates. Currently European wind power generators face average balancing costs at 2 - 3 EUR/MWh. EU Member States without balancing obligation have to include this responsibility, to be in line with the EEAG 2014-2020.

¹⁰ "G-charges" is the name assigned by ACER to the annual average transmission charges faced by producers for the use of transmission networks.

6 References

- [1] European Commission, "C(2015) 6317 final COMMUNICATION FROM THE COMMISSION Towards an Integrated Strategic Energy Technology (SET) Plan: Accelerating the European Energy System Transformation," 2015. [Online]. Available: <https://ec.europa.eu/energy/en/publications/towards-integrated-strategic-energy-technology-set-plan-accelerating-european-energy>.
- [2] European Commission, "SET-Plan – Declaration on Strategic Targets in the context of an Initiative for Global Leadership in Offshore Wind," 2016. [Online]. Available: <https://setis.ec.europa.eu/implementing-integrated-set-plan/no-1-renewables-ongoing-work>.
- [3] European Commission, "COMMUNICATION FROM THE COMMISSION TO THE EUROPEAN PARLIAMENT, THE COUNCIL, THE EUROPEAN ECONOMIC AND SOCIAL COMMITTEE, THE COMMITTEE OF THE REGIONS AND THE EUROPEAN INVESTMENT BANK Clean Energy For All Europeans COM/2016/0860 final," 2016. [Online]. Available: http://ec.europa.eu/energy/sites/ener/files/documents/1_en_act_part1_v7_1.pdf.
- [4] European Technology and Innovation Platform on Wind Energy, "Strategic research and innovation agenda 2016," no. September, 2016.
- [5] IRPWind, "Integrated Research Programme on Wind Energy – Integration of national projects according to the EERA JP and IRPWIND strategy Work Package: WP2 Integrating Activities," 2015.
- [6] GWEC, "Global wind statistics 2015," Brussels, 2016.
- [7] CWEA, "China's 2015 wind power installed capacity statistics briefing," Beijing, 2016.
- [8] WindEurope, "The European offshore wind industry – Key trends and statistics 2016," 2016.
- [9] CWEA, "China's 2015 wind power installed capacity statistics briefing," Beijing, 2016.
- [10] 4coffshore, "Block Island Wind Offshore Wind Farm <http://www.4coffshore.com/windfarms/block-island-wind-farm-united-states-us12.html> (accessed 15.01.2017)." 2017.
- [11] 4coffshore, "Keuka 125kw rim-drive-liquid-air-storage 1:100 scale prototype offshore wind farm." [Online]. Available: <http://www.4coffshore.com/windfarms/keuka-125kw-rim-drive-liquid-air-storage-1-100-scale-prototype-united-states-us4n.html>.
- [12] DoE, "Offshore wind advanced technology demonstration projects," 2016.
- [13] Bloomberg (restricted access), "China's Wind Turbine Makers Face Market Consolidation," 2016. [Online]. Available: <http://www.bloomberg.com/news/articles/2014-04-17/china-s-wind-turbine-makers-face-consolidation-as-glut-lingers>.
- [14] A. D. Hansen, F. Iov, F. Blaabjerg, and L. H. Hansen, "Review of contemporary wind turbine concepts and their market penetration," *Wind Engineering*, vol. 3, pp. 247–263, 2004.
- [15] J. Serrano-Gonzalez and R. Lacal-Aránegui, "Technological evolution of onshore wind turbines—a market-based analysis," *Wind Energy*, vol. 19, no. 12, pp. 2171–2187, 2016.
- [16] R. Lacal-Aránegui and J. Serrano-

- Gonzalez, "2014 JRC wind status report," 2015.
- [17] R. James and M. Costa Ros, "Floating Offshore Wind: Market and Technology Review," 2015.
- [18] "Adwen and LM Wind Power partner to present the longest blade in the world," *Adwenoffshore*, 2016. [Online]. Available: <http://www.adwenoffshore.com/adwen-and-lm-wind-power-partner-to-present-the-longest-blade-in-the-world-2/>.
- [19] E. de Vries, "Exclusive: Many small pieces, one very large blade," *Wind Power Monthly*, 2015. [Online]. Available: <http://www.windpowermonthly.com/article/1352890/exclusive-small-pieces-one-large-blade>.
- [20] "US Team Developing Mega Turbines Inspired by Palm Trees," *offshoreWIND.biz*, 2015. [Online]. Available: <http://www.offshorewind.biz/2015/12/28/us-team-developing-mega-turbines-inspired-by-palm-trees/>.
- [21] N. M. Albuquerque, "Sandia Labs News Releases," *Sandia National Laboratories*, 2016. [Online]. Available: https://share.sandia.gov/news/resources/news_releases/big_blades/#.V6wo rvmxVpi.
- [22] E. de Vries, "WindTech: Full wind field data from blade sensors," *Wind Power Monthly*, 2015. [Online]. Available: <http://www.windpowermonthly.com/article/1335308/windtech-full-wind-field-data-blade-sensors>.
- [23] J. Quilter, "Drones: gimmick or game-changer?," *Wind Power Monthly*, 2016. [Online]. Available: <http://www.windpowermonthly.com/article/1380741/drones-gimmick-game-changer>.
- [24] "Siemens low noise wind turbine blades inspired by silent flight of the owl," *Siemens*, 2016. [Online]. Available: [http://www.siemens.com/press/en/pressrelease/?press=/en/pressrelease/2016/windpower-renewables/pr2016090418wpen.htm&content\[\]=WP](http://www.siemens.com/press/en/pressrelease/?press=/en/pressrelease/2016/windpower-renewables/pr2016090418wpen.htm&content[]=WP).
- [25] "Big Picture: Raising expectations," *Wind Power Monthly*, 2016. [Online]. Available: <http://www.windpowermonthly.com/article/1403505/big-picture-raising-expectations>.
- [26] D. Weston, "Nordex installs 230-metre onshore turbine," *Wind Power Monthly*, 2016. [Online]. Available: <http://www.windpowermonthly.com/article/1400374/nordex-installs-230-metre-onshore-turbine>.
- [27] Dong Energy, "Successful installation of world's largest offshore wind turbine at Burbo Bank Extension," 2016. [Online]. Available: <http://www.burbobankextension.co.uk/en/news/articles/successful-installation-of-world%E2%80%99s-largest-offshore-wind-turbine-at-burbo-bank-extension>.
- [28] S. Sritharan, "Wind turbine towers. Precast concrete Hexcrete may help increase renewable energy capacity with taller hub heights," *PCI Journal*, pp. 33–38, 2015.
- [29] N. Azar, "Hexcrete: A New Concept for Taller Wind Turbine Towers," *Siemens*, 2015. [Online]. Available: <http://www.siemens.com/innovation/en/home/pictures-of-the-future/energy-and-efficiency/sustainable-power-generation-windpower-hexcrete-tower.html>.
- [30] P. Dvorak, "Siemens intros concrete tower to reduce energy costs," *Windpowerengineering*, 2016. [Online]. Available: <http://www.windpowerengineering.com/featured/business-news->

- projects/siemens-intros-concrete-tower-tech-reduce-energy-costs/.
- [31] E. de Vries, "WindTech: Wooden tower design challenges convention," *Wind Power Monthly*, 2015. [Online]. Available: <http://www.windpowermonthly.com/article/1357316/windtech-wooden-tower-design-challenges-convention>.
- [32] "Gallery: Wooden tower prototype could save 20%," *Wind Power Monthly*, 2015. [Online]. Available: <http://www.windpowermonthly.com/article/1360996/gallery-wooden-tower-prototype-save-20>.
- [33] E. de Vries, "Windtech: Concepts to eliminate or reduce PMG use," *Wind Power Monthly*, 2016. [Online]. Available: <http://www.windpowermonthly.com/article/1396547/windtech-concepts-eliminate-reduce-pmg-use>.
- [34] "GreenSpur Renewables has developed a new low cost direct drive (DD) permanent magnet generator (PMG) for the wind turbine market," *GreenSpur Renewables*, 2016. [Online]. Available: <http://www.greenspur.co.uk/>.
- [35] V. K. Pathak, A. K., Khan, M., Gschneidner, K. A., McCallum, R. W., Zhou, L., Sun, K., Dennis, K. W., Zhou, C., Pinkerton, F. E., Kramer, M. J. and Pecharsky, "Cerium: An Unlikely Replacement of Dysprosium in High Performance Nd-Fe-B Permanent Magnets," *Advanced Materials*, vol. 27, no. 16, pp. 2663-2667, 2015.
- [36] "Venpower," *Venpower*, 2016. [Online]. Available: <http://www.venpower.de/en/index.html>.
- [37] E. de Vries, "Turbines of the year: Drivetrains," *Wind Power Monthly*, 2015. [Online]. Available: <http://www.windpowermonthly.com/article/1377330/turbines-year-drivetrains>.
- [38] J. Buist, "Software modelling highlights gearbox cracks," *Wind Power Monthly*, 2016. [Online]. Available: <http://www.windpowermonthly.com/article/1391653/software-modelling-highlights-gearbox-cracks>.
- [39] P. Dvorak, "Geislinger Compowind coupling reduces non-torque drivetrain loads," *Windpowerengineering*, 2015. [Online]. Available: <http://www.windpowerengineering.com/design/mechanical/couplings/geislinger-compowind-coupling-reduces-non-torque-drivetrain-loads/>.
- [40] "The Pre-Post Study results of the Geislinger Compowind® Coupling," *Geislinger*, 2016. [Online]. Available: <http://www.geislinger.com/en/blog/post/the-pre-post-study-results-of-the-geislinger-compowind-coupling>.
- [41] D. Weston, "Siemens teases a 10MW+ turbine," *Wind Power Monthly*, 2016. [Online]. Available: <http://www.windpowermonthly.com/article/1399841/siemens-teases-10mw+-turbine>.
- [42] "Nissum Bredning Offshore Wind Farm," *4coffshore*, 2016. [Online]. Available: <http://www.4coffshore.com/windfarms/nissum-bredning-denmark-dk44.html>.
- [43] "Downsizing the offshore AC substation," *Siemens*, 2015. [Online]. Available: <https://www.siemens.com/customer-magazine/en/home/energy/power-transmission-and-distribution/downsizing-the-offshore-ac-substation.html>.
- [44] S. Heimbach, "Siemens revolutionizes grid connection for offshore wind power plants," in *Ninth National Maritime Conference, Bremerhaven*, 2015.
- [45] "VBMS first to install 66kV cables for Blyth offshore wind farm," *VBMS*,

2016. [Online]. Available: <http://www.vbms.com/en/news/detail/vbms-first-to-install-66kv-cables-for-blyth-offshore-wind-farm>.
- [46] “Vestas challenges scaling rules with multi-rotor concept demonstration turbine,” *Vestas*, 2016.
- [47] D. Weston, “First power from Vestas four-rotor concept,” *Wind Power Monthly*, 2016. [Online]. Available: <http://www.windpowermonthly.com/article/1401013/first-power-vestas-four-rotor-concept>.
- [48] T. Kellner, “How Does A Wind Turbine Work? With GE’s New EcoROTR, Better Than Ever,” *GE Reports*, 2015. [Online]. Available: <http://www.gereports.com/post/120795016210/how-does-a-wind-turbine-work-with-ges-new/>.
- [49] T. Casey, “‘Ugly Duckling’ Wind Turbine From GE Could Produce Some Beautiful Numbers,” *Cleantechnica*, 2015. [Online]. Available: <http://cleantechnica.com/2015/06/09/ugly-duckling-wind-turbine-ge-produce-beautiful-numbers/>.
- [50] Council of European Energy Regulators, “Status Review of Renewable and Energy Efficiency Support Schemes in Europe,” 2015.
- [51] Council of European Energy Regulators, “Status Review of Renewable and Energy Efficiency Support Schemes in Europe,” 2013.
- [52] European Wind Energy Association, “EWEA position paper on network tariffs and grid connection regimes (revisited),” 2016.
- [53] European Wind Energy Association, “Balancing responsibility and costs of wind power plants,” 2015.

APPENDIX A JRC WIND ENERGY DATABASE

The following tables collect the countries and the capacity identified in the JRC Wind Energy Database considered in the analysis of trends of technological indicators conducted in sections 1.1 and 1.1:

Table 2 Countries breakdown in each market

Market	Countries
Europe	Austria; Belgium, Bulgaria, Croatia, Cyprus, Czech Republic, Denmark, Estonia, Finland, France, Germany, Greece, Hungary, Ireland, Italy, Latvia, Lithuania, Luxembourg, Malta, Netherlands, Poland, Portugal, Romania, Slovenia, Slovakia, Spain, Sweden, the United Kingdom, Turkey, Faroe Island, Iceland, Norway, Russia, Switzerland, Ukraine, Macedonia, Serbia
Asia	Bangladesh, China, Fiji, India, Iran, Israel, Japan, Jordan, South Korea, Sri Lanka, Taiwan, Thailand, Vietnam, Pakistan, Philippines, Mongolia, Kazakhstan
North America	Canada, the United States, Mexico
RoW	Albania, Algeria, Argentina, Armenia, Australia, Azerbaijan, Bahamas, Belarus, Bolivia, Bosnia & Herzegovina, Brazil, Cape Verde, Chile, Colombia, Costa Rica, Crimea, Cuba, Dominican Republic, Ecuador, Egypt, Eritrea, Ethiopia, Honduras, Jamaica, Kenya, Maldives, Mauritius, Morocco, New Zealand, Nicaragua, Panama, Peru, Puerto Rico, Saint Kitts and Nevis, Seychelles, Somalia, South Africa, Tunisia, Uruguay, Vanuatu, Venezuela, Guatemala, Mauritania, Falkland Islands, Guadeloupe

Table 3 Onshore capacity included in JRC Wind Energy Database

Geographical region	Capacity (MW)									
	2006	2007	2008	2009	2010	2011	2012	2013	2014	2015
Europe	7,487	8,551	8,428	10,731	9,043	8,118	8,962	10,542	11,682	11,377
Asia	2,688	4,515	8,104	15,797	21,126	20,027	15,047	18,197	21,433	24,748
North America	3,477	5,312	8,923	11,465	6,546	8,339	14,760	3,006	7,377	10,725
RoW	467	358	676	1,380	748	1,391	1,817	2,079	5,376	4,448

Table 4 Data completeness of technological indicator for onshore wind energy in JRC Wind Energy Database

Technological indicator	Geographical region	Capacity identified (%)									
		2006	2007	2008	2009	2010	2011	2012	2013	2014	2015
Rated power	Europe	99.6	99.5	99.6	100	99.9	98.9	99.8	99.4	98.7	100
	Asia	100	100	100	100	100	99.8	100	100	99.8	99.7
	North America	100	100	100	100	100	98.8	100	100	100	100
	RoW	100	100	100	98.6	100	100	100	100	100	100
Wind Class	Europe	75.7	85.1	92.2	91.6	96.4	94.5	95.5	94.7	83.1	88.3
	Asia	58.7	70.3	73.0	84.7	85.2	86.6	89.0	67.6	49.0	21.7
	North America	99.6	96.7	98.2	98.9	99.9	96.7	99.7	93.8	94.3	96.8
	RoW	77.8	90.5	98.0	95.9	97.9	98.5	100	88.5	94.8	91.5
Specific power	Europe	90.3	94.9	95.1	93.3	98.3	95.3	97.5	97.3	97.9	99.2
	Asia	87.1	94.4	96.1	94.7	91.3	90.9	99.6	85.8	70.8	35.1
	North America	97.3	92.6	86.4	95.4	93.8	93.9	95.1	99.6	100	100
	RoW	100	100	100	98.6	100	100	100	88.0	100	97.5
Rotor diameter	Europe	90.3	94.9	95.1	93.3	98.3	95.3	97.5	97.3	97.9	99.2
	Asia	87.1	94.4	96.1	94.7	91.3	90.9	99.6	85.8	70.8	35.1
	North America	97.3	92.6	86.4	95.4	93.8	93.9	95.1	99.6	100	100
	RoW	100	100	100	98.6	100	100	100	88.0	100	97.5
Hub height	Worldwide	30.9	24.9	31.7	33.0	38.7	34.6	27.2	7.2	3.4	0.7
Drive train configuration	Europe	87.8	93.2	94.1	92.7	97.5	95.4	97.3	97.5	97.6	98.3
	Asia	85.3	93.3	94.1	93.9	89.0	85.9	84.9	66.8	56.1	24.8
	North America	96.5	95.8	98.5	99.8	99.5	94.9	98.5	99.1	99.7	97.9
	RoW	99.5	99.9	98.5	96.4	100	98.7	100	91.1	100	97.0

Note: India data in 2015 are not complete in JRC Wind Energy Database

Table 5 Offshore capacity included in JRC Wind Energy Database

Geographical region	Capacity (MW)									
	2006	2007	2008	2009	2010	2011	2012	2013	2014	2015
Europe	200.6	225.6	329.4	801.1	1,578.3	886.6	1,484.1	813.8	1,807.0	2,331.5
Asia	-	1.5	-	136.0	16.5	213.0	55.0	94.4	105.5	429.2
North America	-	-	-	-	-	-	-	-	-	0.1

Table 6 Data completeness of each technological indicators for offshore wind energy in JRC Wind Energy Database

Technological indicator	Geographical region	Capacity identified (%)									
		2006	2007	2008	2009	2010	2011	2012	2013	2014	2015
Rated power	Europe	100	100	100	100	100	100	100	100	100	100
	Asia	-	100	-	100	100	100	100	100	100	100
	North America	-	-	-	-	-	-	-	-	-	100
Specific power	Europe	100	100	100	100	100	100	100	100	100	100
	Asia	-	100	-	94.1	84.8	97.7	100	93.6	50.2	76.7
	North America	-	-	-	-	-	-	-	-	-	0
Rotor diameter	Europe	100	100	100	100	100	100	100	100	100	100
	Asia	-	100	-	94.1	84.8	97.7	100	93.6	50.2	76.7
	North America	-	-	-	-	-	-	-	-	-	0
Hub height	Europe	100	100	100	100	100	99.8	100	99.4	66.5	86.6
	Asia	-	100	-	75.0	100	48.7	9.1	44.9	-	49.7
	North America	-	-	-	-	-	-	-	-	-	0
Drive train configuration	Europe	100	100	100	100	100	100	100	100	100	100
	Asia	-	100	-	91.2	84.8	97.7	100	76.7	31.3	34.8
	North America	-	-	-	-	-	-	-	-	-	0

APPENDIX B WIND CLASSES

Table 7 Wind classes according to IEC 61400-1 standards

Wind class turbine	I	II	III	S
Reference wind speed average (V_{ref}) over 10 min (m/s)*	50	42.5	37.5	Values specified by the designer
Turbulence category		A: 0.16		
		B: 0.14		
		C: 0.12		

* The annual average wind speed (V_{ave}) is calculated as: $V_{ave} = 0.2V_{ref}$

APPENDIX C DRIVE TRAIN CONFIGURATION

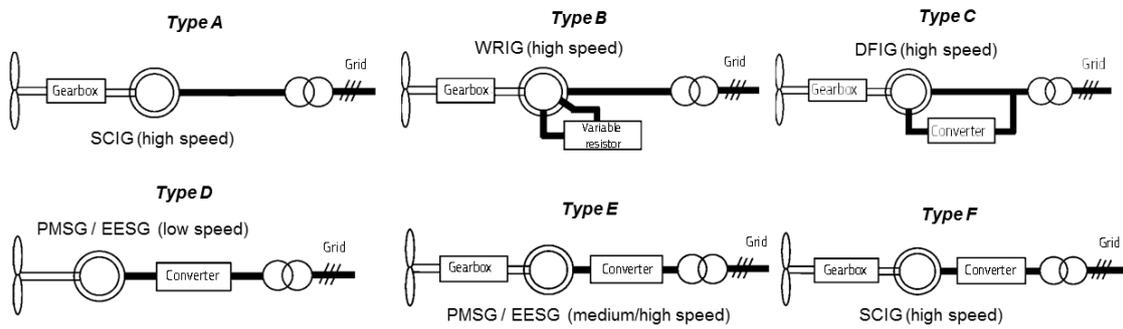

Figure 41 Wind turbine types according to drive train configuration
Source: [14], [15], [16])

APPENDIX D SCIENTIFIC PUBLICATIONS AND PARTICIPATION IN EU FUNDED PROJECTS IN KEY WIND TURBINE COMPONENTS

The analysis of R&D status in key wind turbine components presented in section 3.4 has been done through Tools for Innovation Monitoring (TIM) software. TIM is fully developed by the JRC that allows to analyse and visualise large datasets. Its database contains three different types of documents (scientific publications, patents and EU granted projects). All types of documents are considered from 1996 onwards with the exemption of EU granted projects, which database starts in 1998 with FP5 (Fifth Framework Programme for Research and Technological Development). Scientific publications are obtained from Scopus, while patents come from PATSTAT and EU granted projects are extracted from CORDIS. The coverage of each type of document is not homogenous and depends on what it is available from the providers when indexing the data. In this sense, the reader should keep in mind that there is a significant lag in patent data for the last three years. This can be explained due to the fact that patent documents are published 18 months after their application, have to be cleaned and processed when coming from other authorities than EPO, and this database is released just twice per year. For these reasons, JRC estimates that the coverage reaches almost 100 % for $y-4$ and just 10 % for $y-1$.

Search queries with a specific syntax are used to retrieve data. Due to its state of development, outputs obtained with the TIM tool should be taken as a general overview more than as a precised result.

Methodology

To define the datasets considered in this report we use Boolean search strings such as *Dataset definition = ti_abs_key: ("blades" AND "wind turbine") NOT class: patent AND emm_year: [2011 TO 2015]*, for each component. All outputs are exported in an Excel sheet and processed using VBA.

The first visualisation (Figure 31) is based on the type of documents TIM contains (scientific publications, patents and EU granted projects). In the case of geographical zones in section 3.4.1, we sum all the country contributions that belong to the same geographical zone and that are obtained through the country diagram in TIM. For the sector classification in section 3.4.2 we consider as public sector all institutions that are not companies (classified as "private sector") either undefined entries such as addresses or cities (classified as "other"). Finally, we obtain the Top 5 institutions per component through the organisation diagram in TIM (Figure 37).

Visualisations

The analyses shown in section 3.4 focuses on the main components of a wind turbine (i.e. blades, towers, bearings, gearboxes, electric generators, power converters, control systems and nacelles), which also display the larger number of contributions to scientific documents and EU granted projects in the last five years. For their visualisation we classify the result in the following areas:

- type of documents,
- geographical zones (Asia, Europe, North America and RoW),
- sector (private, public and other) and
- the Top 5 institutions.

It is important to note that we also distinguish between number of documents and number of contributions. Number of documents refers to the amount of scientific publications, patents and EU granted projects that queries retrieve, while number of contributions refers to the participation of a certain institution within a document. For instance, institution A and institution B publish a scientific paper together. Then, the number of documents is one (the scientific paper itself) but the number of contributions to that document is two (one contribution from institution A and another one from institution B) as both institutions take part on it.

APPENDIX E SUPPORT SCHEMES FOR NEW WIND ENERGY PROJECTS AND GRID ISSUES

Table 8 Overview of support schemes for new installations and grid issues in EU Member States

EU MS	SUPPORT SCHEME		CONNECTION				OPERATION		
	ONSHORE	OFFSHORE	CONNECTION REGIME	NETWORK TARIFFS		G-CHARGE	ACCESS REGIME	DISPATCHING REGIME	BALANCING RESPONSIBILITY
				CONNECTION CHARGE APPROACH					
				DISTRIBUTION LEVEL	TRANSMISSION LEVEL				
AT	FIT	-	NON-DISCRIMINATORY	DEEP	SHALLOW	YES	OTHER	PRIORITY DISPATCHING	YES
BE	TGC	TGC	PRIORITY CONNECTION	SHALLOW	SHALLOW	YES	PRIORITY ACCESS	PRIORITY DISPATCHING	YES
BG	FIT	-	NON-DISCRIMINATORY	N/A	DEEP	NO	N/A	N/A	YES
CY	Cancelled	-	NON-DISCRIMINATORY	SHALLOW-DEEP	SHALLOW	NO	N/A	N/A	NO
CZ	Cancelled	-	NON-DISCRIMINATORY	SHALLOW	SHALLOW	N/A	PRIORITY ACCESS	PRIORITY DISPATCHING	N/A
DE	FIP	FIP	PRIORITY CONNECTION	SHALLOW-DEEP	SHALLOW	NO	PRIORITY ACCESS	PRIORITY DISPATCHING	PARTLY
DK	FIP	FIP tender-based	PRIORITY CONNECTION	SHALLOW	SHALLOW	YES	PRIORITY ACCESS	PRIORITY DISPATCHING	YES
EE	FIP	-	NON-DISCRIMINATORY	N/A	DEEP	YES	GUARANTEED ACCESS	PRIORITY DISPATCHING	YES
ES	Capacity payment tender-based	-	PRIORITY CONNECTION	SHALLOW	SHALLOW	YES	PRIORITY ACCESS	PRIORITY DISPATCHING	YES
FI	FIP	-	NON-DISCRIMINATORY	SHALLOW-DEEP	SHALLOW	YES	GUARANTEED ACCESS	NON-PRIORITY	YES
FR	FIT	FIT tender-based	NON-DISCRIMINATORY	DEEP	SHALLOW	YES	PRIORITY ACCESS	PRIORITY DISPATCHING	NO
GR	FIP	FIP	NON-DISCRIMINATORY	DEEP	SHALLOW	NO	GUARANTEED ACCESS	PRIORITY DISPATCHING	NO
HR	FIP tender-based	-	NON-DISCRIMINATORY	DEEP	DEEP	NO	PRIORITY ACCESS	PRIORITY DISPATCHING	NO
HU	FIT tender-based	-	PRIORITY CONNECTION	SHALLOW-DEEP	SHALLOW-DEEP	NO	PRIORITY ACCESS	PRIORITY DISPATCHING	N/A
IE	FIT	-	NON-DISCRIMINATORY	SHALLOW-DEEP	SHALLOW-DEEP	YES	GUARANTEED ACCESS	PRIORITY DISPATCHING	NO
IT	FIT tender-based	FIT tender-based	PRIORITY CONNECTION	SHALLOW-DEEP	SHALLOW	NO	PRIORITY ACCESS	PRIORITY DISPATCHING	YES
LT	FIT tender-based	-	PRIORITY CONNECTION	SHALLOW-DEEP	DEEP	NO	PRIORITY ACCESS	PRIORITY DISPATCHING	NO
LU	FIT	-	PRIORITY CONNECTION	SHALLOW-DEEP	SHALLOW-DEEP	NO	GUARANTEED ACCESS	PRIORITY DISPATCHING	N/A
LV	FIT tender-based	-	NON-DISCRIMINATORY	N/A	N/A	NO	N/A	N/A	N/A
MT	Cancelled	-	PRIORITY CONNECTION	N/A	N/A	NO	N/A	N/A	NO
NL	FIP tender-based	FIP tender-based	NON-DISCRIMINATORY	SHALLOW-DEEP	SHALLOW	NO	GUARANTEED ACCESS	NON-PRIORITY	YES
PL	CfD tender-based	CfD tender-based	PRIORITY CONNECTION	SHALLOW	SHALLOW	NO	PRIORITY ACCESS	PRIORITY DISPATCHING	YES
PT	Cancelled	-	NON-DISCRIMINATORY	DEEP	SHALLOW	YES	GUARANTEED ACCESS	PRIORITY DISPATCHING	NO
RO	TGC	-	NON-DISCRIMINATORY	DEEP	SHALLOW-DEEP	YES	GUARANTEED ACCESS	PRIORITY DISPATCHING	YES
SE	TGC	TGC	NON-DISCRIMINATORY	DEEP	DEEP	YES	GUARANTEED ACCESS	NON-PRIORITY	YES
SI	FIP	-	PRIORITY CONNECTION	SHALLOW-DEEP	SHALLOW	NO	N/A	N/A	YES
SK	FIT	-	PRIORITY CONNECTION	DEEP	SHALLOW-DEEP	YES	PRIORITY ACCESS	N/A	N/A
UK	TGC; CfD tender-based	TGC; CfD tender-based	NON-DISCRIMINATORY	SHALLOW-DEEP	SHALLOW	YES	GUARANTEED ACCESS	PRIORITY DISPATCHING	YES

Source: JRC based on BNEF and EWEA [50], [51], [52], [53]

Note: Support schemes in force in July 2016 and grid issues updated in June 2016

LIST OF ABBREVIATIONS AND ACRONYMS

AC	Alternating Current
ACER	Agency for the Cooperation of Energy Regulators
CapEx	Capital expenditure or capital cost
CfD	Contract for Difference
CORDIS	Community Research and Development Information Service
DC	Direct Current
DFIG	Doubly-Fed Induction Generator
EcoROTR	Energy Capture Optimization by Revolutionary Onboard Turbine Reshape
EEAG	State Aid Guidelines for Environmental protection and Energy
EERA	European Energy Research Alliance
EESG	Electrically Excited Synchronous Generator
EPO	European Patent Office
ETIPWind	European Technology and Innovation Platform on Wind Energy
EU	European Union
EU MS	Member State of the European Union
EU28	28 Member States of the European Union
EUR	Euros
FIP	Feed-in Premium
FIT	Feed-in Tariff
FP	Framework Programme
GW	Gigawatt= 10^9 watts
GWEC	Global Wind Energy Council
H2020	Horizon 2020 framework programme
HVAC	High Voltage Alternating Current
HVDC	High Voltage Direct Current
IEA	International Energy Agency
IEC	International Electrotechnical Commission
IPP	Independent Power Producers
IRPWind	Integrated Research Programme on Wind Energy
ITC	Investment Tax Credit
JRC	Joint Research Centre
km	kilometre
KPI	Key Performance Indicator
kV	kiloVolt= 10^3 Volt
kW	kilowatt= 10^3 watts
LCoE	Levelised Cost of Energy
LDST	Large-diameter steel tower
m	meter
MoDaR	Morphing Downwind-Aligned Rotor
MVAC	Medium Voltage Alternating Current
OEM	Original Equipment Manufacturer
O&M	Operation and maintenance
OpEx	Operational expenditure
OTM	Offshore Transformer Module
PMSG	Permanent Magnet Synchronous Generator
PTC	Production Tax Credit
R&D	Research and Development
RoE	Rest of Europe
RoW	Rest of the World

SCIG	Squirrel Cage Induction Generator
SET Plan	Strategic Energy Technology Plan
SUMR	Segmented Ultralight Morphing Rotor
TGC	Tradable Green Certificates
TIM	Tools for Innovation Monitoring
TLP	Tension Leg Platform
TRL	Technology Readiness Level
TWh	Terawatt-hours = 10^{12} watt-hours
WRIG	Wound-Rotor Induction Generator
W/m ²	Watts per square meter

Throughout this report 2-letter country codes are used as per the International Organisation for Standardisation: http://www.iso.org/iso/country_names_and_code_elements

LIST OF FIGURES

<i>Figure 1 Strategic targets for offshore wind energy</i>	1
<i>Figure 2 Cumulative worldwide installed onshore wind capacity 2010-2015</i>	3
<i>Figure 3 Cumulative worldwide installed offshore wind capacity 2010-2015. Source: JRC wind energy database</i>	5
<i>Figure 4 Evolution of the Top 10 turbine manufacturers 2010-2015</i>	6
<i>Figure 5 Evolution of turbine manufacture market concentration 2005-2015</i>	7
<i>Figure 6 Developers market for projects commissioned or expected to be commissioned in 2013-2015, 206-2018 and 2019-2020</i>	7
<i>Figure 7 Foundations installation market 2013-2015. Number of installations per company</i> ..	7
<i>Figure 8 Foundations installation market 2016-2018. Number of installations per company</i> ..	8
<i>Figure 9 Evolution of nominal power of onshore wind turbines in the world</i>	9
<i>Figure 10 Evolution of onshore project size in the world</i>	9
<i>Figure 11 Evolution of the share of installed capacity by wind class in onshore wind turbines by geographical zone</i>	10
<i>Figure 12 Comparison of wind class in onshore wind turbines of the Top 10 European countries in terms of installed capacity in 2006 vs 2015</i>	10
<i>Figure 13 Evolution of the specific power in onshore wind turbines by geographical zone</i>	11
<i>Figure 14 Evolution of the rotor diameter in onshore wind turbines by geographical zone</i>	12
<i>Figure 15 Evolution of hub height in onshore wind turbines</i>	12
<i>Figure 16 Evolution of the share of installed capacity by drive train configuration in onshore wind turbines by geographical zone</i>	13
<i>Figure 17 Drive train configuration according to nominal power in onshore wind turbines installed during 2015 and different geographical zones</i>	14
<i>Figure 18 Drive train configuration across the Top 10 OEMs in terms of total installed capacity of onshore wind energy in the world</i>	15
<i>Figure 19 Evolution of nominal power of offshore wind turbines in the world</i>	15
<i>Figure 20 Evolution of offshore project size in the world</i>	16
<i>Figure 21 Evolution of the specific power in offshore wind turbines in the world</i>	16
<i>Figure 22 Evolution of the rotor diameter in offshore wind turbines in the world</i>	16
<i>Figure 23 Evolution of the hub height in offshore wind turbines in the world</i>	16
<i>Figure 24 Evolution of the share of installed capacity by drive train configuration in offshore wind turbines by geographical zone</i>	17
<i>Figure 25 Drive train configuration across the Top 10 OEMs in terms of total installed capacity of offshore wind energy in the world</i>	17
<i>Figure 26 Evolution of global offshore wind projects according to their project size, distance to shore and water depth</i>	18
<i>Figure 27 Type of foundations in offshore wind projects (by the end of 2015)</i>	19
<i>Figure 28 Fixed-grounded foundation types of fully commissioned offshore wind projects in the world by water depth and wind turbine nominal power</i>	19
<i>Figure 29 Geographical distribution of floating foundation typologies (December 2016)</i>	21
<i>Figure 30 Voltage of submarine transmission connection to onshore grid in worldwide offshore wind projects indicating project size and distance from shore</i>	22
<i>Figure 31 Share of scientific documents, EU granted projects and patents retrieved from TIM on wind turbine components in the year 2011</i>	27

<i>Figure 32 Share of scientific documents and EU granted projects retrieved from TIM on wind turbine components in the period 2011-2015</i>	<i>27</i>
<i>Figure 33 Geographical distribution and number of R&D contributions (publications and participation in EU projects) in wind turbine components</i>	<i>28</i>
<i>Figure 34 Distribution and number of R&D contributions (publications and participation in EU projects) in wind turbine components by the Top 10 countries</i>	<i>28</i>
<i>Figure 35 Bibliometric maps (countrygrams) of the main players in R&D contributions (scientific publications and participations in EU granted projects) for blades (LEFT) and offshore foundations (RIGHT).....</i>	<i>29</i>
<i>Figure 36 Distribution of R&D contributions (publications and participation in EU granted projects) in wind turbine components</i>	<i>30</i>
<i>Figure 37 Distribution of R&D contributions (publications and participation in EU projects) across the Top 5 institutions in each wind turbine component.....</i>	<i>30</i>
<i>Figure 38 Horizon 2020-funded projects on wind energy coordinated by one European country and classified according to EU funding received, project duration and main research and innovation areas addressed.....</i>	<i>32</i>
<i>Figure 39 Horizon 2020-funded projects on wind energy participated by different countries and classified according to EU funding received, project duration and main research and innovation areas addressed.....</i>	<i>33</i>
<i>Figure 40 Overview of support schemes for new onshore (LEFT) and offshore (RIGHT) wind energy projects (at utility-scale) in EU Member States (in force in July 2016)</i>	<i>35</i>
<i>Figure 41 Wind turbine types according to drive train configuration.....</i>	<i>44</i>

LIST OF TABLES

<i>Table 1 Types of drive train configurations</i>	13
<i>Table 2 Countries breakdown in each market</i>	41
<i>Table 3 Onshore capacity included in JRC Wind Energy Database</i>	41
<i>Table 4 Data completeness of technological indicator for onshore wind energy in JRC Wind Energy Database</i>	41
<i>Table 5 Offshore capacity included in JRC Wind Energy Database</i>	42
<i>Table 6 Data completeness of each technological indicators for offshore wind energy in JRC Wind Energy Database</i>	42
<i>Table 7 Wind classes according to IEC 61400-1 standards</i>	43
<i>Table 8 Overview of support schemes for new installations and grid issues in EU Member States</i>	47

***Europe Direct is a service to help you find answers
to your questions about the European Union.***

Freephone number (*):

00 800 6 7 8 9 10 11

(* The information given is free, as are most calls (though some operators, phone boxes or hotels may charge you).

More information on the European Union is available on the internet (<http://europa.eu>).

HOW TO OBTAIN EU PUBLICATIONS

Free publications:

- one copy:
via EU Bookshop (<http://bookshop.europa.eu>);
- more than one copy or posters/maps:
from the European Union's representations (http://ec.europa.eu/represent_en.htm);
from the delegations in non-EU countries (http://eeas.europa.eu/delegations/index_en.htm);
by contacting the Europe Direct service (http://europa.eu/eurodirect/index_en.htm) or
calling 00 800 6 7 8 9 10 11 (freephone number from anywhere in the EU) (*).

(* The information given is free, as are most calls (though some operators, phone boxes or hotels may charge you).

Priced publications:

- via EU Bookshop (<http://bookshop.europa.eu>).

JRC Mission

As the science and knowledge service of the European Commission, the Joint Research Centre's mission is to support EU policies with independent evidence throughout the whole policy cycle.



EU Science Hub
ec.europa.eu/jrc



@EU_ScienceHub



EU Science Hub - Joint Research Centre



Joint Research Centre



EU Science Hub



Publications Office

doi:10.2760/332535

ISBN 978-92-79-66940-8