



EUROPEAN COMMISSION

**Integrated Pollution Prevention and Control
(IPPC)**

**Reference Document on
Best Available Techniques in the
Large Volume Organic Chemical Industry
February 2003**

EXECUTIVE SUMMARY

The Large Volume Organic Chemicals (LVOC) BREF (Best Available Techniques reference document) reflects an information exchange carried out under Article 16(2) of Council Directive 96/61/EC. This Executive Summary - which is intended to be read in conjunction with both the standard introduction to the BAT chapters and the BREF Preface's explanations of objectives, usage and legal terms - describes the main findings, the principal BAT conclusions and the associated emission / consumption levels. It can be read and understood as a stand-alone document but, as a summary, it does not present all the complexities of the full BREF text. It is therefore not intended as a substitute for the full BREF text as a tool in BAT decision making.

Document scope and organisation: For the purposes of BAT information exchange the organic chemical industry has been divided into sectors for 'Large Volume Organic Chemicals', 'Polymers' and 'Fine Organic Chemicals'. The IPPC directive does not use the term 'Large Volume Organic Chemicals' and so offers no assistance in its definition. The TWG interpretation, however, is that it covers those activities in sections 4.1(a) to 4.1(g) of Annex 1 to the Directive with a production rate of more than 100 kt/yr. In Europe, some 90 organic chemicals meet these criteria. It has not been possible to carry out a detailed information exchange on every LVOC process because the scope of LVOC is so large. The BREF therefore contains a mixture of generic and detailed information on LVOC processes:

- *Generic information:* LVOC applied processes are described both in terms of widely used unit processes, unit operations and infrastructure (Chapter 2), and also using brief descriptions of the main LVOC processes (Chapter 3). Chapter 4 gives the generic origins, and possible composition, of LVOC emissions and Chapter 5 outlines the available emission prevention and control techniques. Chapter 6 concludes by identifying those techniques that are considered to be generic BAT for the LVOC sector as a whole.
- *Detailed information:* The LVOC industry has been divided into eight sub-sectors (based on functional chemistry) and, from these, 'illustrative processes' have been selected to demonstrate the application of BAT. The seven illustrative processes are characterised by major industrial importance, significant environmental issues and operation at a number of European sites. There are no illustrative processes for the LVOC sub-sectors covering sulphur, phosphorous and organo-metal compounds but for other sub-sectors they are:

Sub-sector	Illustrative process
Lower Olefins	Lower olefins (by the cracking process) - Chapter 7
Aromatics	Benzene / toluene / xylene (BTX) aromatics – Chapter 8
Oxygenated compounds	Ethylene oxide & ethylene glycols – Chapter 9 Formaldehyde – Chapter 10
Nitrogenated compounds	Acrylonitrile – Chapter 11 Toluene diisocyanate – Chapter 13
Halogenated compounds	Ethylene dichloride (EDC) & Vinyl Chloride Monomer (VCM) – Chapter 12

Valuable information on LVOC processes is also to be found in other BREFs. Of particular importance are the 'horizontal BREFs' (especially Common waste water and waste gas treatment/management systems in the chemical industry, Storage and Industrial cooling systems) and vertical BREFs for related processes (especially Large Combustion Plants).

Background information (Chapter 1)

LVOC encompasses a large range of chemicals and processes. In very simplified terms it can be described as taking refinery products and transforming them, by a complex combination of physical and chemical operations, into a variety of 'commodity' or 'bulk' chemicals; normally in continuously operated plants. LVOC products are usually sold on chemical specifications rather than brand name, as they are rarely consumer products in their own right. LVOC products are more commonly used in large quantities as raw materials in the further synthesis of higher value chemicals (e.g. solvents, plastics, drugs).

LVOC processes are usually located on large, highly integrated production installations that confer advantages of process flexibility, energy optimisation, by-product re-use and economies of scale. European production figures are dominated by a relatively small number of chemicals manufactured by large companies. Germany is Europe's largest producer but there are well-established LVOC industries in the Netherlands, France, the UK, Italy, Spain and Belgium.

LVOC production has significant economic importance in Europe. In 1995 the European Union was an exporter of basic chemicals, with the USA and EFTA countries being the main recipients. The market for bulk chemicals is very competitive, with cost of production playing a very large part, and market share is often considered in global terms. The profitability of the European LVOC industry is traditionally very cyclical. This is accentuated by high capital investment costs and long lead-times for installing new technology. As a result, reductions in manufacturing costs tend to be incremental and many installations are relatively old. The LVOC industry is also highly energy intensive and profitability is often linked to oil prices.

The 1990s saw a stronger demand for products and a tendency for major chemical companies to create strategic alliances and joint ventures. This has rationalised research, production and access to markets, and increased profitability. Employment in the chemicals sector continues to decline and dropped by 23 % in the ten-year period from 1985 to 1995. In 1998, a total of 1.6 million staff were employed in the EU chemicals sector.

Generic LVOC production process (Chapter 2)

Although processes for the production of LVOC are extremely diverse and complex, they are typically composed of a combination of simpler activities and equipment that are based on similar scientific and engineering principles. Chapter 2 describes how unit processes, unit operations, site infrastructure, energy control and management systems are combined and modified to create a production sequence for the desired LVOC product. Most LVOC processes can be described in terms of five distinct steps, namely: raw material supply / work-up, synthesis, product separation / refining, product handling / storage, and emission abatement.

Generic applied processes and techniques (Chapter 3)

Since the vast majority of LVOC production processes have not benefited from a detailed information exchange, Chapter 3 provides very brief ('thumbnail') descriptions of some 65 important LVOC processes. The descriptions are restricted to a brief outline of the process, any significant emissions, and particular techniques for pollution prevention / control. Since the descriptions aim to give an initial overview of the process, they do not necessarily describe all production routes and further information may be necessary to reach a BAT decision.

Generic emissions from LVOC processes (Chapter 4)

Consumption and emission levels are very specific to each process and are difficult to define and quantify without detailed study. Such studies have been undertaken for the illustrative processes but, for other LVOC processes, Chapter 4 gives generic pointers to possible pollutants and their origins. The most important causes of process emissions are[InfoMil, 2000 #83]:

- contaminants in raw materials may pass through the process unchanged and exit as wastes
- the process may use air as an oxidant and this creates a waste gas that requires venting
- process reactions may yield water / other by-products requiring separation from the product
- auxiliary agents may be introduced into the process and not fully recovered
- there may be unreacted feedstock which cannot be economically recovered or re-used.

The exact character and scale of emissions will depend on such factors as: plant age; raw material composition; product range; nature of intermediates; use of auxiliary materials; process conditions; extent of in-process emission prevention; end-of-pipe treatment technique; and the operating scenario (i.e. routine, non-routine, emergency). It is also important to understand the actual environmental significance of such factors as: plant boundary definition; the degree of process integration; definition of emission basis; measurement techniques; definition of waste; and plant location.

Generic techniques to consider in the determination of BAT (Chapter 5)

Chapter 5 provides an overview of generic techniques for the prevention and control of LVOC process emissions. Many of the techniques are also described in relevant horizontal BREFs. LVOC processes usually achieve environmental protection by using a combination of techniques for process development, process design, plant design, process-integrated techniques and end-of-pipe techniques. Chapter 5 describes these techniques in terms of management systems, pollution prevention and pollution control (for air, water and waste).

Management systems. Management systems are identified as having a central role in minimising the environmental impact of LVOC processes. The best environmental performance is usually achieved by the installation of the best technology and its operation in the most effective and efficient manner. There is no definitive Environmental Management System (EMS) but they are strongest where they form an inherent part of the management and operation of a LVOC process. An EMS typically addresses the organisational structure, responsibilities, practices, procedures, processes and resources for developing, implementing, achieving, reviewing and monitoring the environmental policy[InfoMil, 2000 #83].

Pollution prevention. IPPC presumes the use of preventative techniques before any consideration of end-of-pipe control techniques. Many pollution prevention techniques can be applied to LVOC processes and Section 5.2 describes them in terms of source reduction (preventing waste arisings by modifications to products, input materials, equipment and procedures), recycling and waste minimisation initiatives.

Air pollutant control. The main air pollutants from LVOC processes are Volatile Organic Compounds (VOCs) but emissions of combustion gases, acid gases and particulate matter may also be significant. Waste gas treatment units are specifically designed for a certain waste gas composition and may not provide treatment for all pollutants. Special attention is paid to the release of toxic / hazardous components. Section 5.3 describes techniques for the control of generic groups of air pollutants.

Volatile Organic Compounds (VOCs). VOCs typically arise from process vents, the storage / transfer of liquids and gases, fugitive sources and intermittent vents. The effectiveness and costs of VOC prevention and control will depend on the VOC species, concentration, flow rate, source and target emission level. Resources are typically targeted at high flow, high concentration, process vents but recognition must be given to the cumulative impact of low concentration diffuse arisings, especially as point sources become increasingly controlled.

VOCs from process vents are, where possible, re-used within processes but this is dependent on such factors as VOC composition, any restrictions on re-use and VOC value. The next alternative is to recover the VOC calorific content as fuel and, if not, there may be a requirement for abatement. A combination of techniques may be needed, for example: pre-treatment (to remove moisture and particulates); concentration of a dilute gas stream; primary removal to reduce high concentrations, and finally polishing to achieve the desired release levels. In general terms, condensation, absorption and adsorption offer opportunities for VOC capture and recovery, whilst oxidation techniques involve VOC destruction.

VOCs from fugitive emissions are caused by vapour leaks from equipment as a result of gradual loss of the intended tightness. The generic sources may be stem packing on valves / control valves, flanges / connections, open ends, safety valves, pump / compressor seals, equipment manholes and sampling points. Although the fugitive loss rates from individual pieces of equipment are usually small, there are so many pieces on a typical LVOC plant that the total loss of VOCs may be very significant. In many cases, using better quality equipment can result in significant reductions in fugitive emissions. This does not generally increase investment costs on new plants but may be significant on existing plants, and so control relies more heavily on Leak Detection and Repair (LDAR) programmes. General factors that apply to all equipment are:

- minimising the number of valves, control valves and flanges, consistent with plant safe operability and maintenance needs.
- improving access to potential leaking components to enable effective maintenance.
- leaking losses are hard to determine and a monitoring programme is a good starting point to gain insight into the emissions and the causes. This can be the basis of an action plan
- the successful abatement of leaking losses depends heavily on both technical improvements and the managerial aspects since motivation of personnel is an important factor
- abatement programmes can reduce the unabated losses (as calculated by average US-EPA emission factors) by 80 - 95 %
- special attention should be paid to long term achievements
- most reported fugitive emissions are calculated rather than monitored and not all calculation formats are comparable. Average emissions factors are generally higher than measured values.

Combustion units (process furnaces, steam boilers and gas turbines) give rise to emissions of carbon dioxide, nitrogen oxides, sulphur dioxide and particulates. Nitrogen oxide emissions are most commonly reduced by combustion modifications that reduce temperatures and hence the formation of thermal NO_x. The techniques include low NO_x burners, flue gas recirculation, and reduced pre-heat. Nitrogen oxides can also be removed after they have formed by reduction to nitrogen using Selective Non Catalytic Reduction (SNCR) or Selective Catalytic Reduction (SCR).

Water pollutant control. The main water pollutants from LVOC processes are mixtures of oil / organics, biodegradable organics, recalcitrant organics, volatile organics, heavy metals, acid / alkaline effluents, suspended solids and heat. In existing plants, the choice of control techniques may be restricted to process-integrated (in-plant) control measures, in-plant treatment of segregated individual streams and end-of-pipe treatment. New plants may provide better opportunities to improve environmental performance through the use of alternative technologies to prevent waste water arisings.

Most waste water components of LVOC processes are biodegradable and are often biologically treated at centralised waste water treatment plants. This is dependent on first treating or recovering any waste water streams containing heavy metals or toxic or non-biodegradable organic compounds using, for example, (chemical) oxidation, adsorption, filtration, extraction, (steam) stripping, hydrolysis (to improve bio-degradability) or anaerobic pre-treatment.

Waste control. Wastes are very process-specific but the key pollutants can be derived from knowledge of: the process, construction materials, corrosion / erosion mechanisms and maintenance materials. Waste audits are used to gather information on the source, composition, quantity and variability of all wastes. Waste prevention typically involves preventing the arising of waste at source, minimising the arisings and recycling any waste that is generated. The choice of treatment technique is very specific to the process and the type of waste arisings and is often contracted-out to specialised companies. Catalysts are often based on expensive metals and are regenerated. At the end of their life the metals are recovered and the inert support is landfilled. Purification media (e.g. activated carbon, molecular sieves, filter media, desiccants and ion exchange resins) are regenerated where possible but landfill disposal and incineration (under appropriate conditions) may also be used. The heavy organic residues from distillation columns and vessel sludges etc. may be used as feedstock for other processes, or as a fuel (to capture the calorific value) or incinerated (under appropriate conditions). Spent reagents (e.g. organic solvents), that cannot be recovered or used as a fuel, are normally incinerated (under appropriate conditions).

Heat emissions may be reduced by 'hardware' techniques (e.g. combined heat and power, process adaptations, heat exchange, thermal insulation). Management systems (e.g. attribution of energy costs to process units, internal reporting of energy use/efficiency, external benchmarking, energy audits) are used to identify the areas where hardware is best employed.

Techniques to reduce *vibrations* include: selection of equipment with inherently low vibration, anti-vibration mountings, the disconnection of vibration sources and surroundings and consideration at the design stage of proximity to potential receptors.

Noise may arise from such equipment as compressors, pumps, flares and steam vents. Techniques include: noise prevention by suitable construction, sound absorbers, noise control booth / encapsulation of the noise sources, noise-reducing layout of buildings, and consideration at the design stage of proximity to potential receptors.

A number of *evaluation tools* may be used to select the most appropriate emission prevention and control techniques for LVOC processes. Such evaluation tools include risk analysis and dispersion models, chain analysis methods, planning instruments, economic analysis methods and environmental weighting methods.

Generic BAT (Chapter 6)

The component parts of Generic BAT are described in terms of management systems, pollution prevention / minimisation, air pollutant control, water pollutant control and wastes / residues control. Generic BAT applies to the LVOC sector as a whole, regardless of the process or product. BAT for a particular LVOC process is, however, determined by considering the three levels of BAT in the following order of precedence:

1. illustrative process BAT (where it exists)
2. LVOC Generic BAT; and finally
3. any relevant Horizontal BAT (especially from the BREFs on waste water / waste gas management and treatment, storage and handling, industrial cooling, and monitoring).

Management systems: Effective and efficient management systems are very important in the attainment of high environmental performance. BAT for environmental management systems is an appropriate combination or selection of, *inter alia*, the following techniques:

- an environmental strategy and a commitment to follow the strategy
- organisational structures to integrate environmental issues into decision-making
- written procedures or practices for all environmentally important aspects of plant design, operation, maintenance, commissioning and decommissioning
- internal audit systems to review the implementation of environmental policies and to verify compliance with procedures, standards and legal requirements
- accounting practices that internalise the full costs of raw materials and wastes
- long term financial and technical planning for environmental investments
- control systems (hardware / software) for the core process and pollution control equipment to ensure stable operation, high yield and good environmental performance under all operational modes
- systems to ensure operator environmental awareness and training
- inspection and maintenance strategies to optimise process performance
- defined response procedures to abnormal events
- ongoing waste minimisation exercises.

Pollution prevention and minimisation: The selection of BAT for LVOC processes, for all media, is to give sequential consideration to techniques according to the hierarchy:

- a) eliminate arisings of all waste streams (gaseous, aqueous and solid) through process development and design, in particular by high-selectivity reaction step and proper catalyst
- b) reduce waste streams at source through process-integrated changes to raw materials, equipment and operating procedures
- c) recycle waste streams by direct re-use or reclamation / re-use
- d) recover any resource value from waste streams
- e) treat and dispose of waste streams using end-of-pipe techniques.

BAT for the design of new LVOC processes, and for the major modification of existing processes, is an appropriate combination or selection of the following techniques:

- carry out chemical reactions and separation processes continuously, in closed equipment
- subject continuous purge streams from process vessels to the hierarchy of: re-use, recovery, combustion in air pollution control equipment, and combustion in non-dedicated equipment
- minimise energy use and to maximise energy recovery
- use compounds with low or lower vapour pressure
- give consideration to the principles of ‘Green Chemistry’.

BAT for the prevention and control of **fugitive emissions** is an appropriate combination or selection of, *inter alia*, the following techniques:

- a formal Leak Detection and Repair (LDAR) programme to focus on the pipe and equipment leak points that provide the highest emission reduction per unit expenditure
- repair pipe and equipment leaks in stages, carrying out immediate minor repairs (unless this is impossible) on points leaking above some lower threshold and, if leaking above some higher threshold, implement timely intensive repair. The exact threshold leak rate at which repairs are performed will depend on the plant situation and the type of repair required.
- replace existing equipment with higher performance equipment for large leaks that cannot otherwise be controlled
- install new facilities built to tight specifications for fugitive emissions
- the following, or equally efficient, high performance equipment:
 - **valves**: low leak rate valves with double packing seals. Bellow seals for high-risk duty
 - **pumps**: double seals with liquid or gas barrier, or seal-less pumps
 - **compressors and vacuum pumps**: double seals with liquid or gas barrier, or seal-less pumps, or single seal technology with equivalent emission levels
 - **flanges**: minimise the number, use effective gaskets
 - **open ends**: fit blind flanges, caps or plugs to infrequently used fittings; use closed loop flush on liquid sampling points; and, for sampling systems / analysers, optimise the sampling volume/frequency, minimise the length of sampling lines or fit enclosures.
 - **safety valves**: fit upstream rupture disk (within any safety limitations).

BAT for **storage, handling and transfer** is, in addition to those in the Storage BREF, an appropriate combination or selection of, *inter alia*, the following techniques:

- external floating roof with secondary seals (not for highly dangerous substances), fixed roof tanks with internal floating covers and rim seals (for more volatile liquids), fixed roof tanks with inert gas blanket, pressurised storage (for highly dangerous or odorous substances)
- inter-connect storage vessels and mobile containers with balance lines
- minimise the storage temperature
- instrumentation and procedures to prevent overfilling
- impermeable secondary containment with a capacity of 110 % of the largest tank
- recover VOCs from vents (by condensation, absorption or adsorption) before recycling or destruction by combustion in an energy raising unit, incinerator or flare
- continuous monitoring of liquid level and changes in liquid level
- tank filling pipes that extend beneath the liquid surface
- bottom loading to avoid splashing
- sensing devices on loading arms to detect undue movement
- self-sealing hose connections / dry break coupling
- barriers and interlock systems to prevent accidental movement or drive-away of vehicles.

BAT for preventing and minimising the emission of **water pollutants** is an appropriate combination or selection of the following techniques:

- A. identify all waste water arisings and characterise their quality, quantity and variability
- B. minimise water input to the process
- C. minimise process water contamination with raw material, product or wastes
- D. maximise waste water re-use
- E. maximise the recovery / retention of substances from mother liquors unfit for re-use.

BAT for **energy efficiency** is an appropriate combination or selection of the following techniques: optimise energy conservation; implement accounting systems; undertake frequent energy reviews; optimise heat integration; minimise the need for cooling systems; and adopt Combined Heat and Power systems where economically and technically viable.

BAT for the prevention and minimisation of **noise and vibration** is an appropriate combination or selection of the following techniques:

- adopt designs that disconnect noise / vibration sources from receptors
- select equipment with inherently low noise / vibration levels; use anti-vibration mountings; use sound absorbers or encapsulation
- periodic noise and vibration surveys.

Air pollutant control: The BAT selection requires consideration of parameters such as: pollutant types and inlet concentrations; gas flow rate; presence of impurities; permissible exhaust concentration; safety; investment & operating cost; plant layout; and availability of utilities. A combination of techniques may be necessary for high inlet concentrations or less efficient techniques. Generic BAT for air pollutants is an appropriate combination or selection of the techniques given in Table A (for VOCs) and Table B (for other process related air pollutants).

Technique	BAT-associated values ⁽¹⁾	Remark
Selective membrane separation	90 - >99.9 % recovery VOC < 20 mg/m ³	Indicative application range 1 - >10g VOC/m ³ Efficiency may be adversely affected by, for example, corrosive products, dusty gas or gas close to its dew point.
Condensation	Condensation: 50 - 98 % recovery + additional abatement. Cryo-condensation: ⁽²⁾ 95 - 99.95 % recovery	Indicative application range: flow 100 - >100000 m ³ /h, 50 - >100g VOC/m ³ . For cryo-condensation: flow 10 - 1000 m ³ /h, 200 - 1000 g VOC/m ³ , 20 mbar-6 bar
Adsorption ⁽²⁾	95 - 99.99 % recovery	Indicative application range for regenerative adsorption: flow 100 - >100000 m ³ /h, 0.01 - 10g VOC/m ³ , 1 - 20 atm. Non regenerative adsorption: flow 10 - >1000 m ³ /h, 0.01 - 1.2g VOC/m ³
Scrubber ⁽²⁾	95 - 99.9 % reduction	Indicative application range: flow 10 - 50000 m ³ /h, 0.3 - >5g VOC/m ³
Thermal incineration	95 - 99.9 % reduction VOC ⁽²⁾ < 1 - 20 mg/m ³	Indicative application range: flow 1000 - 100000m ³ /h, 0.2 - >10g VOC/m ³ . Range of 1 - 20 mg/m ³ is based on emission limits & measured values. The reduction efficiency of regenerative or recuperative thermal incinerators may be lower than 95 - 99 % but can achieve < 20 mg/Nm ³ .
Catalytic oxidation	95 - 99 % reduction VOC < 1 - 20 mg/m ³	Indicative application range: flow 10 - 100000 m ³ /h, 0.05 - 3 g VOC/m ³
Flaring	Elevated flares > 99 % Ground flares > 99.5 %	

1. Unless stated, concentrations relate to half hour / daily averages for reference conditions of dry exhaust gas at 0 °C, 101.3 kPa and an oxygen content of 3 vol% (11 vol% oxygen content in the case of catalytic / thermal oxidation).

2. The technique has cross-media issues that require consideration.

Table A: BAT-associated values for the recovery / abatement of VOCs

Pollutant	Technique	BAT-associated values ⁽¹⁾	Remark
Particulates	Cyclone	Up to 95 % reduction	Strongly dependent on the particle size. Normally only BAT in combination with another technique (e.g. electrostatic precipitator, fabric filter).
	Electrostatic precipitator	5 – 15 mg/Nm ³ 99 – 99.9 % reduction	Based on use of the technique in different (non-LVOC) industrial sectors. Performance of is very dependent on particle properties.
	Fabric Filter	< 5 mg/Nm ³	
	Two stage dust filter	~ 1 mg/Nm ³	
	Ceramic filter	< 1 mg/Nm ³	
	Absolute Filter	< 0.1 mg/Nm ³	
	HEAF Filter	Droplets & aerosols up to 99 % reduction	
	Mist Filter	Dust & aerosols up to 99 % reduction	
Odour	Adsorption Biofilter	95 - 99 % reduction for odour and some VOC	Indicative application range: 10000 - 200000 ou/Nm ³
Sulphur dioxide & acid gases	Wet limestone scrubbing	90 – 97 % reduction SO ₂ < 50 mg/Nm ³	Indicative range of application for SO ₂ < 1000 mg/m ³ in the raw gas.
	Scrubbers	HCl ⁽²⁾ < 10 mg/Nm ³ HBr ⁽²⁾ < 5 mg/Nm ³	Concentrations based on Austrian permit limits.
	Semi Dry Sorbent Injection	SO ₂ < 100 mg/Nm ³ HCl < 10 - 20 mg/Nm ³ HF < 1 - 5 mg/Nm ³	Indicative range of application for SO ₂ < 1000 mg/m ³ in the raw gas.
Nitrogen oxides	SNCR	50 – 80 % NO _x reduction	
	SCR	85 to 95 % reduction NO _x < 50 mg/m ³ . Ammonia < 5 mg/m ³	May be higher where the waste gas contains a high hydrogen concentration.
Dioxins	Primary measures + adsorption 3-bed catalyst	< 0.1 ng TEQ/Nm ³	Generation of dioxins in the processes should be avoided as far as possible
Mercury	Adsorption	0.05 mg/Nm ³	0.01 mg/Nm ³ measured at Austrian waste incineration plant with activated carbon filter.
Ammonia & amines	Scrubber	< 1 – 10 mg/Nm ³	Acid scrubber
Hydrogen sulphide	Absorption (alkaline scrubber)	1 - 5 mg/Nm ³	Absorption of H ₂ S is 99 %+. An alternative is absorption in an ethanolamine scrubber followed by sulphur recovery.

1. Unless stated, concentrations relate to half hour / daily averages for reference conditions of dry exhaust gas at 0 °C, 101.3 kPa and an oxygen content of 3 vol%.

2. Daily mean value at standard conditions. The half hourly values are HCl < 30 mg/m³ and HBr < 10 mg/m³.

Table B: BAT-associated values for the abatement of other LVOC air pollutants

Air pollutants emitted from LVOC processes have widely different characteristics (in terms of toxicity, global warming, photochemical ozone creation, stratospheric ozone depletion etc.) and are classified using a variety of systems. In the absence of a pan-European classification system, Table C presents BAT-associated levels using the Dutch NeR system. The NeR is consistent with a high level of environmental protection but is just one example of good practice. There are other, equally valid, classification systems that can be used to establish BAT-associated levels, some of which are outlined in Annex VIII of the BREF.

Categories **	Possible BAT solutions (not an exhaustive list)	BAT-associated emission level (mg/Nm ³) ***	Threshold (kg/h)
Extremely hazardous substances			
Dioxins & furans	Process integrated: good operating conditions and low chlorine in feedstock/fuel.	0.1 (ng I-TEQ/Nm ³)	no threshold
PCB's	End of pipe: Activated carbon, catalytic fabric filter, incinerator.	0.1**** (ng PCB -TEQ/Nm ³)	no threshold
Particulates			
Particulate matter	If filtration is not possible, up to 25 applies	10 – 25	≥ 0.5
	If filtration is not possible, up to 50 applies	10 - 50	< 0.5
Carcinogenic substances*			
∑ C1	Incinerator, scrubber, absolute filter, activated carbon.	0.1	0.0005
∑ C1 + C2		1.0	0.005
∑ C1 + C2 + C3		5.0	0.025
Organic substances (gas/vapour)*			
∑ gO1	Incinerator, (regenerative) activated carbon, vapour recovery unit.	20	0.1
∑ gO1 + gO2		100	2.0
∑ gO1+ gO2 + gO3		100 - 150	3.0
Organic substances (solid)*			
∑ sO1	If filtration is not possible, up to 25 applies	10 – 25	≥ 0.1
	If filtration is not possible, up to 50 applies	10 - 50	< 0.1
∑ sO1 + sO2	If filtration is not possible, up to 25 applies	10 – 25	≥ 0.5
	If filtration is not possible, up to 50 applies	10 - 50	< 0.5
∑ sO1 + sO2 + sO3	If filtration is not possible, up to 25 applies	10 – 25	≥ 0.5
	If filtration is not possible, up to 50 applies	10 - 50	< 0.5
Inorganic substances (gas/vapour)			
gI1	Many different solutions (e.g. chemical scrubber, alkaline scrubber, activated carbon)	1.0	0.01
gI2		5.0	0.05
gI3		30	0.3
gI4	Acid/alkaline scrubber, S(N)CR, lime injection.	200	5
Inorganic substances (solid)*			
∑ sI1	Fabric filter, Scrubber, Electrostatic precipitator	0.2	0.001
∑ sI1 + sI2		1.0	0.005
∑ sI1 + sI2 + sI3		5.0	0.025
* The summation rule applies (i.e. the given emission level applies to the sum of the substances in the relevant category plus those of the lower category).			
** Detailed substance classification is given in Annex VIII: Member State air pollutant classification systems.			
*** The emission level only applies when the mass threshold (of untreated emissions) is exceeded. Emission levels relate to half hourly averages at normal conditions (dry exhaust gas, 0°C and 101.3 kPa). Oxygen concentration is not defined in the NeR but is usually the actual oxygen concentration (for incinerators 11 vol% oxygen may be acceptable).			
**** Levels for PCBs are given here in terms of TEQ, for the relevant factors to calculate these levels, see article "Toxic Equivalency Factors (TEFs) for PCBs, PCDDs, PCDFs for Humans and Wildlife". "Van den Berg et al. Environmental Health Perspectives, Volume 106, No 12, December 1998"			

Table C: Air emission levels associated with BAT for process vents in the LVOC industry

BAT for **flaring** is an appropriate combination or selection of, *inter alia*: plant design / operation to minimise the need for hydrocarbon disposal to the flare system. The choice between ground flares and elevated flares is based on safety. Where elevated flares are used, BAT includes permanent pilots / pilot flame detection, efficient mixing and remote monitoring by Closed Circuit Television. The BAT-associated reduction values for VOC are >99% for elevated flares and >99.5% for ground flares.

BAT for **process furnaces** is gas firing and low-NO_x burner configuration to achieve associated emissions of 50 - 100 mg NO_x /Nm³ (as an hourly average) for new and existing situations. The BAT for **other combustion units** (e.g. steam boilers, gas turbines) can be found in the BREF on Large Combustion Plant.

BAT for **carbon dioxide emissions** is improved energy efficiency, but a switch to low-carbon (hydrogen-rich) fuels or sustainable non-fossil fuels may also be considered BAT.

Water pollutant control: BAT for water pollutants is an appropriate combination or selection of, *inter alia*, the following techniques:

- separate treatment or recovery of waste water streams containing heavy metals or toxic or non-biodegradable organic compounds using (chemical) oxidation, adsorption, filtration, extraction, (steam) stripping, hydrolysis or anaerobic pre-treatment, and subsequent biological treatment. The BAT-associated emission values in individual treated waste streams are (as daily averages): Hg 0.05 mg/l; Cd 0.2 mg/l; Cu / Cr / Ni / Pb 0.5 mg/l; and Zn / Sn 2 mg/l.
- organic waste water streams not containing heavy metals or toxic or non-biodegradable organic compounds are potentially fit for combined biological treatment in a lowly loaded plant (subject to evaluation of biodegradability, inhibitory effects, sludge deterioration effects, volatility and residual pollutant levels). The BAT-associated BOD level in the effluent is less than 20 mg/l (as a daily average).

LVOC process waste waters are strongly influenced by, *inter alia*, the applied processes, operational process variability, water consumption, source control measures and the extent of pre-treatment. But on the basis of TWG expert judgement, the BAT-associated emission levels (as daily averages) are: COD 30 – 125 mg/l; AOX < 1 mg/l; and total nitrogen 10 - 25 mg/l.

Wastes and residues control: BAT for wastes and residues is an appropriate combination or selection of, *inter alia*, the following techniques:

- catalysts - regeneration / re-use and, when spent, to recover the precious metal content
- spent purification media - regeneration where possible, and if not to landfill or incinerate
- organic process residues - maximise use as feedstock or as fuel, and if not to incinerate
- spent reagents - maximise recovery or use as fuel, and if not to incinerate.

Illustrative process: Lower Olefins (Chapter 7)

General information: Lower Olefins encompasses the largest group of commodity chemicals within the LVOC sector and are used for a very wide range of derivatives. In 1998, European ethylene production was 20.3 million tonnes and propylene production was 13.6 million tonnes. The steam cracking route accounts for more than 98 % of ethylene, and 75 % of propylene, production. There are currently some 50 steam crackers in Europe. The average European plant size is around 400 kt/yr and the largest are close to one million tonnes per year. Suitable feedstocks for olefins production range from light gases (e.g. ethane and LPGs) to the refinery liquid products (naphtha, gas-oil). Heavier feedstocks generally give a higher proportion of co-products (propylene, butadiene, benzene) and need larger / more complex plants. All lower olefins are sold on product specification rather than performance and this promotes international markets where selling price is the dominant factor. Steam cracking plants use proprietary technology licensed from a small number of international engineering contractors. The generic designs are similar but specific process details, especially in the furnace area, are dictated by feedstock choice / properties. Global competition has ensured that no one technology gives a major performance advantage and technology selection is typically influenced by previous experience, local circumstances and total installed capital cost.

Applied process: The steam cracking process is highly endothermic (15 to 50 GJ/t ethylene), with the 'cracking' reactions taking place in pyrolysis furnaces at temperatures above 800°C. In contrast, the subsequent recovery and purification of olefin products involves cryogenic separation at temperatures down to -150°C and pressures of 35 bar. Plant designs are highly integrated for energy recovery. The highly volatile and flammable nature of the feedstocks / products demands a high standard of overall plant containment integrity, including the extensive use of closed relief systems, resulting in a total hydrocarbon loss over the cracker as low as 5 to 15 kg/t ethylene in the best performing plants.

Consumption / emissions: The large scale of steam cracking operations means that potential emissions are significant.

Air. Pyrolysis furnaces burn low-sulphur gases (often containing hydrogen) and combustion emissions (CO₂, CO, NO_x) account for the majority of process air emissions. Emissions of sulphur dioxide and particulates occur from the use, as fuel, of less valuable cracker products (e.g. in auxiliary boilers or other process heaters) and the combustion of coke deposited on furnace coils. VOC emissions may arise from combustion processes, fugitive losses and point source losses from atmospheric vents.

Water. In addition to general effluents (e.g. boiler feed water) there are three specific effluent streams, namely; process water (dilution steam blow-down), spent caustic and decoke drum spray water (where installed). Streams that have been in contact with hydrocarbon fluids may contain pollutants such as: hydrocarbons; dissolved inorganic solids and particulates; materials with a chemical or biological demand for oxygen, and trace quantities of metal cations.

Solid wastes. Relatively little solid waste is generated in the steam cracking process when the feedstock is gas or naphtha, although oily sludges are generated when using gas-oil feed. Most solid wastes are organic sludge and coke, but spent catalysts, adsorbents and various solvents may require periodic disposal.

Best Available Techniques:

Process selection: The steam cracking process is the only large-scale process currently available for producing the full range of lower olefins and it is generally BAT. There is not a BAT feedstock although emissions from plants using gas feedstock tend to be lower than from plants using naphtha or gas oil.

Emissions to Air. The selection, maintenance and operation of efficient pyrolysis furnaces represent the single most important BAT for minimising atmospheric emissions. Modern furnaces have thermal efficiencies in the range 92 – 95 % and utilise natural gas, or more typically residue gas (a mixture of methane and hydrogen). Furnaces incorporate advanced control systems for efficient combustion management and are equipped with either ultra-low NO_x burners (giving BAT-associated emissions of 75 - 100 mg NO_x/Nm³ - hourly average) or Selective Catalytic DeNO_x units (BAT-associated emissions of 60 - 80 mg NO_x/Nm³ - hourly average). BAT-associated ammonia emissions from modern SCR units are <5 mg/m³ (hourly average) at high NO_x reduction rates but higher emissions may occur as the catalyst ages.

Cracking furnaces require to be periodically decoked using an air/steam mixture. The decoking vent gas can be routed either to the furnace fireboxes or to a separate decoke drum, where emissions of particulates can be controlled to less than 50 mg/Nm³ (hourly average) by the use of spray water or cyclone recovery systems.

High capacity, elevated flare stacks are a characteristic of ethylene plants since they provide a safe disposal route for hydrocarbons in the event of a major plant upset. Flaring not only creates an environmental impact (visibility, noise) but also represents a significant loss of value to the operator. BAT is therefore to minimise flaring through the use of proven, highly reliable plant and equipment, provision of recycle facilities for material sent to flare and alternative disposal routes (e.g. into other parts of the process stream for out-of-specification material). The development and use of good management practices for the operation and maintenance of the assets also play an important role in maximising performance and hence minimising emissions. Continuous monitoring by closed circuit television, automated flow-ratio controlled steam injection, and pilot flame detection are BAT to minimise the duration and magnitude of any flaring event. Under optimum conditions, the combustion efficiency in flares is 99 %.

Acid gases, including carbon dioxide and sulphur dioxide, are removed from the cracked gas by reaction with sodium hydroxide (in some cases having first reduced the acid gas loading by the use of regenerable amine scrubbing). A sour gas emission may be present if the plant is not able to recover its spent caustic stream, or use wet air oxidation techniques to treat the stream prior to

disposal to aqueous effluent. When the spent caustic is treated by acidification, gaseous hydrogen sulphide is created which is either sent to a suitable incinerator (where it is combusted to sulphur dioxide) or more rarely sent to a nearby Claus unit for sulphur recovery.

BAT is to avoid the use of atmospheric vents for the storage and handling of volatile hydrocarbons. BAT for the minimisation of fugitive emissions is the extensive use of welded piping, the utilisation of high integrity seal systems for pumps / compressors, and appropriate gland packing materials for isolation / control valves, backed up by effective management systems for emission monitoring and reduction through planned maintenance.

Emissions to Water. BAT for aqueous effluents is the application of process integrated techniques and recycling / further processing to maximise recovery before final treatment.

- BAT for the process water stream (effluent from the condensation of dilution steam used in the cracking furnaces) is a dilution steam generation facility, where the stream is washed to remove heavy hydrocarbons, stripped and revaporised for recycling to the furnaces.
- BAT for the spent caustic stream may be recovery, wet air oxidation, acidification (followed by sulphur recovery or incineration) or sour gas flaring.
- BAT for final effluent treatment includes physical separation (e.g. API separator, corrugated plate separator) followed by polishing (e.g. hydrogen peroxide oxidation or biotreatment). The BAT levels for final water emissions (as daily averages) are, *inter alia*: COD 30 – 45 mg/l and TOC 10 - 15 mg/l (2 - 10 g/t ethylene).

By-products / wastes. BAT includes: periodic removal of organic wastes such as sludges from API separators for disposal by incineration using specialist disposal contractor; spent catalyst and desiccant for disposal to landfill after reclamation of precious metal; and coke fines for disposal in an immobilised form to landfill and/or incineration.

Illustrative process: Aromatics (Chapter 8)

General information: The term ‘aromatics’ describes benzene, toluene, mixed xylenes, ortho-xylene, para-xylene, meta-xylene (commonly known as BTX). Benzene is used to produce styrene, cumene and cyclohexane. Most toluene is used to produce benzene, phenol and toluene diisocyanate. Para-xylene is transformed into polyethylene terephthalate (PET), mixed xylenes are mainly used as solvents and ortho-xylene is used to make phthalic anhydride.

In 1998 the West European aromatics industry produced over 10 million tonnes with a value of \$2.3 billion. The aromatics market is complex and volatile as it concerns six main products that are produced from very different processes and feedstocks. The market prices of aromatics products are linked to each other and also depend on the crude oil cost, naphtha price and exchange rates. In addition, the European Union’s Auto-Oil Directive has, since 01/01/2000, restricted the benzene content of gasoline to <1 % and the subsequent need to recover benzene from upstream feedstocks has caused EU benzene production to increase.

Applied process: BTX aromatics are produced from three main feedstocks: refinery reformates, steam cracker pyrolysis gasoline (pygas) and benzol from coal tar processing. The feedstocks are a mix of aromatics that have to be separated and purified for the chemical market.

- *Benzene:* In Europe, 55 % of benzene comes from pygas, 20 % from reformat, a few percent from coal tar and the balance from chemical treatment of other aromatics. Europe has 57 production units with a combined capacity of 8100 kt/yr.
- *Toluene:* In Europe, pygas and reformat feedstocks each account for 50 % of toluene production. The 28 production units have a combined capacity of 2760 kt/yr.
- *Xylene:* Reformat is the main source of xylenes. Xylenes production normally focuses on para-xylene, but most producers also extract ortho-xylene and meta-xylene. Europe has 11 production units with a combined capacity of 1850 kt/yr.

The choice of production process is a strategic decision that depends on the feedstock availability and cost, and the demand for aromatic products. Such are the variations of feedstock and desired products that each aromatic plant has an almost unique configuration. However, aromatics production from a petrochemical feedstock will utilise some, or all, of a set of closely connected and integrated unit processes that allow:

- The separation of aromatics (from non-aromatics) and the isolation of pure products, using sophisticated physical separation processes (e.g. azeotropic distillation, extractive distillation, liquid-liquid extraction, crystallisation by freezing, adsorption, complexing with BF_3/HF). The most widely used methods are solvent extraction followed by distillation.
- Chemical conversion to more beneficial products using such techniques as: -
 - toluene to benzene by hydrodealkylation (THD or HDA)
 - toluene to benzene and xylene by toluene disproportionation (TDP)
 - xylene and/or m-xylene to p-xylene by isomerisation.

Aromatics production units may be physically located in either refinery or petrochemical complexes and process integration allows the common use of utilities, by-product handling and common facilities such as flare systems and waste water treatment. Most of the aromatic processes are built and designed by international technology providers. There are more than 70 process licences and over 20 licensors, each with different feedstocks and process characteristics to suit local conditions.

Consumption / emissions: Energy consumption will depend on the aromatics content of the feedstock, the extent of heat integration and the technology. Aromatics production processes can be exothermic (e.g. hydrotreating) or energy intensive (e.g. distillation) and there are many opportunities to optimise heat recovery and use.

Emissions from aromatics plants are mainly due to the use of utilities (e.g. heat, power, steam, cooling water) needed by the separation processes. Process designs do not normally incorporate venting to atmosphere and the few emissions from the core process are due to the elimination of impurities, inherent waste streams generated during processing and emissions from equipment.

Best available techniques: It is not possible to identify a BAT process since process selection is so dependent on the available feedstock and the desired products.

Air emissions: BAT is an appropriate selection or combination of, *inter alia*, the following techniques:

- optimise energy integration within the aromatics plant and surrounding units
- for new furnaces, install Ultra Low NO_x burners (ULNBs) or, for larger furnaces, catalytic De-NO_x (SCR). Installation on existing furnaces depends on plant design, size and layout
- route routine process vents and safety valve discharges to gas recovery systems or to flare
- use closed loop sample systems to minimise operator exposure and to minimise emissions during the purging step prior to taking samples
- use 'heat-off' control systems to stop the heat input and shut down plants quickly and safely in order to minimise venting during plant upsets
- use closed piping systems for draining and venting hydrocarbon containing equipment prior to maintenance, particularly when containing >1 wt% benzene or >25 wt% aromatics
- on systems where the process stream contains >1 wt% benzene or >25 wt% total aromatics, the use of canned pumps or single seals with gas purge or double mechanical seals or magnetically driven pumps
- for rising stem manual or control valves, fit bellows and stuffing box, or use high-integrity packing materials (e.g. carbon fibre) when fugitive emission affect occupational exposure
- use compressors with double mechanical seals, or a process-compatible sealing liquid, or a gas seal, or sealless models
- combust hydrogenation off-gases in a furnace with heat recovery facilities

- provide bulk storage of aromatics in [EC DGXI, 1990 #16] double seal floating roof tanks (not for dangerous aromatics such as benzene), or in fixed roof tanks incorporating an internal floating roof with high integrity seals, or in fixed roof with interconnected vapour spaces and vapour recovery or absorption at a single vent
- vents from loading or discharging aromatics to use closed vent systems, bottom-loading and passing evolved vapours to a vapour recovery unit, burner or flare system.

Water emissions: BAT is an appropriate selection or combination of, *inter alia*, the following techniques:

- minimise waste water generation and maximise waste water re-use.
- recover hydrocarbons (e.g. using steam stripping) and recycle the hydrocarbons to fuel or to other recovery systems, and biologically treat the water phase (after oil separation).

Wastes: BAT is an appropriate selection or combination of, *inter alia*, the following techniques:

- recover and re-use the precious metal content of spent catalysts and landfill catalyst support
- incinerate oily sludges and recover the heat
- landfill or incinerate spent clay adsorbents.

Illustrative process: Ethylene Oxide / Ethylene Glycol (Chapter 9)

General information: Ethylene oxide (EO) is a key chemical intermediate in the manufacture of many important products. The main outlet is to ethylene glycols (EG) but other important outlets are ethoxylates, glycol ethers and ethanol amines.

The total European Union production capacity of EO (ex-reactor) is in the order of 2500 kt/yr and is produced at 14 manufacturing sites. Roughly 40 % of this EO is converted into glycols (globally this figure is about 70 %). European installations typically have integrated production of both EO and EG. EO and MEG are sold on chemical specification, rather than on performance in use, and competition is therefore based heavily on price.

Ethylene oxide is toxic and a human carcinogen. EO gas is flammable, even without being mixed with air, and can auto-decompose explosively. Ethylene glycols are stable, non-corrosive liquids that can cause slight eye irritation, or, with repeated contact, skin irritation.

Applied process: Ethylene oxide is produced from ethylene and oxygen (or air) in a gas phase reaction over a silver catalyst. The catalyst is not 100 % selective and part of the ethylene feed is converted to CO₂ and water. The reaction heat released in the EO reactors is recovered by generating steam which is used for heating purposes in the plant. EO is recovered from the gaseous reactor effluent by absorption in water followed by concentration in a stripper. In the oxygen process, part of the recycle gas from the EO absorber is routed through a column in which carbon dioxide is removed by absorption (in a hot potassium carbonate solution) and subsequently removed from the carbonate solution in a stripper.

Ethylene glycols are produced by reacting EO with water at an elevated temperature (typically 150 - 250 °C). The main product is Mono Ethylene Glycol (MEG) but valuable co-products are Di Ethylene Glycol (DEG) and Tri Ethylene Glycol (TEG). MEG is mainly used for the manufacture of polyester fibres and polyethylene terephthalate (PET).

Consumption / emissions: The selectivity of the EO catalyst can have a significant impact on raw material and energy consumption, and on the production of gaseous and liquid effluents, by-products and wastes. The main effluent streams from the EO / EG process are:

- The **CO₂ vent** provides the purge for the CO₂ (and traces of ethylene and methane) formed in the EO reactor. It is recovered for sale or thermally / catalytically oxidised.
- The **inerts vent** provides the purge for inerts present in the ethylene and oxygen feedstocks. The vent mainly contains hydrocarbons and is typically used as fuel gas.

- The **heavy glycols** by-product stream can often be sold to customers.
- The **water bleed** is the combined water effluent of the total EO/EG unit and is sent to a biotreater to degrade the small amounts of water-soluble hydrocarbons (mostly glycols).
- The main source of **solid waste** is spent EO catalyst (which is periodically replaced as activity and selectivity decline). Spent EO catalyst is sent to an external reclaimer for silver recovery and the inert carrier is disposed of.

Best available techniques:

Process route: The BAT process route for **ethylene oxide** is the direct oxidation of ethylene by pure oxygen (due to the lower ethylene consumption and lower off-gas production). The BAT process route for **ethylene glycol** is based on the hydrolysis of EO (with reaction conditions to maximise production of the desired glycol(s) and minimise energy consumption).

Emissions to Air: The techniques to prevent the loss of EO containment, and hence occupational exposure to EO, are also BAT to provide environmental protection.

BAT for the CO₂ vent is recovery of the CO₂ for sale as a product. Where this is not possible, BAT is to minimise CO₂, methane and ethylene emissions by applying more efficient oxidation catalyst, reducing methane and ethylene levels before CO₂ stripping, and/or routing the CO₂ vent to a thermal / catalytic oxidation unit.

BAT for the inerts vent is transfer to a fuel gas system for energy recovery, or flaring (typically reducing EO emission levels to < 1 mg EO/Nm³ - hourly average). If the EO reaction is carried out using air rather than pure oxygen, then BAT is to transfer the inerts excess to a second oxidation reactor to convert most of the residual ethylene into EO.

BAT for EO containing vent gases is:

- water scrubbing to <5 mg EO/Nm³ (hourly average) and release to atmosphere (for vents with a low content of methane and ethylene)
- water scrubbing and recycle to the process (for vent streams with a noticeable content in methane and ethylene)
- minimisation techniques (e.g. pressure balancing & vapour return in storage / loading)

Emissions to Water: BAT for reducing emissions to water is to concentrate partial contributor streams with recovery of a heavy organic stream (for sale or incineration) and route the remaining effluent stream to a biological treatment unit. The application of BAT allows an emission level of 10 - 15g TOC/t EO ex-reactor to be achieved.

By-products and Wastes:

- BAT for heavy glycols is to minimise formation in the process and to maximise possible sales, in order to minimise disposal (e.g. by incineration).
- BAT for spent EO catalyst is optimising catalyst life and then recovery of the silver content prior to appropriate disposal (e.g. landfill).

Illustrative process: Formaldehyde (Chapter 10)

General information: Formaldehyde is widely used for the manufacture of numerous products (e.g. resins, paints), either as 100 % polymers of formaldehyde or a reaction product together with other chemicals. The total European production capacity of 3100 kt/yr is provided by 68 units in 13 Member States. Formaldehyde is toxic and a suspected carcinogenic at high concentrations, but the strong irritating effect means that human exposure to high concentrations is self-limiting. Strict operational practices have also been developed to limit the occupational exposure of workers.

Applied process: Formaldehyde is produced from methanol, either by catalytic oxidation under air deficiency ('silver process') or air excess ('oxide process'). There are further options to

design the silver process for either total or partial methanol conversion. The process routes all have advantages and disadvantages and European formaldehyde production capacity is split roughly equally between the silver and oxide routes.

Consumption / emissions: Electricity and steam are the two main utilities and their consumption is directly linked to process selectivity. The process selectivity is, in turn, a function of the carbon loss (as CO and CO₂) in the reactors. The lower the carbon loss, the higher the selectivity. However, the full oxidation of carbon is very exothermic (compared to the reactions producing formaldehyde) so high carbon loss produces more steam. A poor catalyst therefore produces large quantities of steam but is detrimental to methanol consumption.

Air emissions: For both the silver and oxide processes, the off-gas from the formaldehyde absorption column is the only continuous waste gas stream. The main pollutants are formaldehyde, methanol, CO and dimethyl ether. Further emissions may arise from storage breathing and fugitives.

Water emissions: Under routine operating conditions, the silver and oxide processes do not produce any significant continuous liquid waste streams. Many of occasional arisings can be reworked into the process to dilute the formaldehyde product.

Wastes: There is little formation of solid wastes under normal operating conditions, but there will be spent catalyst, build-up of solid para-formaldehyde and spent filters.

Best available techniques: The BAT production route can be either the oxide or the silver process. Process selection will depend on factors such as: methanol consumption and price; plant production capacity; physical plant size; electricity use; steam production; and catalyst price / life. BAT is to optimise the energy balance taking into account the surrounding site.

Air emissions:

- BAT for vents from the absorber, storage and loading / unloading systems is recovery (e.g. condensation, water scrubber) and / or treatment in a dedicated or central combustion unit to achieve a formaldehyde emission of < 5 mg/Nm³ (daily average)
- BAT for absorber off-gases in the **silver process** is energy recovery in a motor engine or thermal oxidiser to achieve emissions of:
 - carbon monoxide 50 mg/Nm³ as a daily average (0.1 kg/t formaldehyde 100 %)
 - nitrogen oxides (as NO₂) 150 mg/Nm³ as a daily average (0.3 kg/t formaldehyde 100 %)
- BAT for reaction off-gas from the **oxide process** is catalytic oxidation to achieve emissions of: carbon monoxide <20 mg/Nm³ as a daily average (0.05 kg/t formaldehyde 100 %) and nitrogen oxides (as NO₂) <10 mg/Nm³ as a daily average
- BAT for the design of methanol storage tanks is to reduce the vent streams by such techniques as back-venting during loading/unloading.
- BAT for the vents from the storage of methanol and formaldehyde include: thermal / catalytic oxidation, adsorption on activated carbon, absorption in water, recycling to the process, and connection to the suction of the process air blower.

BAT for **waste water** is to maximise re-use as dilution water for the product formaldehyde solution or, when re-use is not possible, biological treatment.

BAT for **catalyst waste** is to first maximise the catalyst life by optimising reaction conditions and then to reclaim the metal content of any spent catalyst.

BAT for the build-up of solid **para-formaldehyde** is to prevent formation in process equipment by optimising heating, insulation and flow circulation, and to reuse any unavoidable arisings.

Illustrative process: Acrylonitrile (Chapter 11)

General information: Acrylonitrile is an intermediate monomer used world-wide for several applications. The majority of European acrylonitrile is used in the production of acrylic fibre, with ABS representing the next most important end user. The EU has seven operational production installations and these account for a nameplate capacity of 1165 kt/yr.

Applied process: The BP/SOHIO process accounts for 95 % of world-wide acrylonitrile capacity and is used in all EU plants. The process is a vapour phase, exothermic ammoxidation of propylene using excess ammonia in the presence of an air-fluidised catalyst bed. Several secondary reactions take place and there are three main co-products, namely:

- hydrogen cyanide, which is either transformed into other products on site; sold as a product (if a use is available); disposed of by incineration; or a combination of all three
- acetonitrile, which is purified and sold as a product, and/or disposed of by incineration
- ammonium sulphate, which is either recovered as a product (e.g. as a fertiliser), or destroyed elsewhere on site.

The consumption of raw materials and energy in the acrylonitrile process are influenced by such factors as catalyst selection, production rate and recovery plant configuration. Propylene and ammonia are the major raw materials but 'make-up' catalyst is also a significant consumable.

Propylene ammoxidation is a highly exothermic reaction. Acrylonitrile plants are generally net exporters of energy as the heat of reaction is used to generate high-pressure steam that is often used to drive air compressors and provide energy to downstream separation / purification units. The energy export range is 340 - 5700 MJ/t acrylonitrile and so site-wide energy management is a key issue.

Water is produced in the reaction step and rejection of water from the process is a critical part of plant design. There are many differing techniques and, in a widely used one, the key step involves concentrating the contaminant in the water stream using evaporation. The concentrated, contaminated stream may be burnt or recycled to other parts of the process to maximise recovery of saleable products (before burning the contaminated stream). The 'clean' water stream recovered from the concentration processes is further treated, normally in biological waste water treatment plants.

The reaction off-gases from the process absorber contains non-condensables (e.g. nitrogen, oxygen, carbon monoxide, carbon dioxide, propylene, propane) as well as vaporised water and traces of organic contaminants. Thermal or catalytic oxidation can be used to treat this stream.

An acrylonitrile plant may have facilities to incinerate process residues and also to burn hydrogen cyanide. The magnitude and composition of flue gases will depend on the use of external facilities and the availability of hydrogen cyanide consumers. There is usually no specific treatment of the flue gas (except for heat recovery).

Owing to the hazardous properties of acrylonitrile and hydrogen cyanide, safety considerations are very important in their storage and handling.

Best Available Techniques: The BAT process is based on the ammoxidation of propylene in a fluid bed reactor, with subsequent recovery of acrylonitrile. Recovery for sale of the main co-products (hydrogen cyanide, acetonitrile and ammonium sulphate) may be BAT depending on local circumstances, but backup recovery / destruction facilities are needed in all cases.

BAT for the absorber off-gas is to reduce the volume through the development of more efficient catalyst and optimised reaction / operation conditions. BAT is then destruction of the organics (to a target acrylonitrile concentration of $< 0.5 \text{ mg/Nm}^3$ - hourly average) in a dedicated thermal

or catalytic oxidiser, or in a common purpose incinerator or in a boiler plant. In all cases BAT will include heat recovery (normally with steam production).

BAT for the miscellaneous vent streams is treatment in either the absorber off-gas treatment system or a common flare system for total destruction of the organics. Other vent streams may be scrubbed (to a target acrylonitrile concentration of $< 5 \text{ mg/Nm}^3$ - hourly average) to allow recycling of recovered components.

Contaminated aqueous effluent streams include effluent from the quench section (containing ammonium sulphate), stripper bottoms stream and discontinuous streams. BAT includes the crystallisation of ammonium sulphate for sale as fertilisers.

BAT for the water streams is pre-treatment by distillation to reduce the light hydrocarbons content and to concentrate or separate heavy hydrocarbons, with the aim of reducing the organics load prior to final treatment. BAT for the recovered light and heavy hydrocarbon streams is further treatment to recover useful components (e.g. acetonitrile) prior to combustion with energy recovery.

BAT for aqueous waste streams is to treat the contaminated effluent stream in a dedicated, central or external waste water treatment plant including biotreatment, to take advantage of the high biodegradability of the organic contaminants. The emission level associated with BAT is 0.4 kg Total Organic Carbon /t acrylonitrile.

Illustrative process: EDC / VCM (Chapter 12)

General information: EDC (1,2 ethylene dichloride) is mainly used for the production of VCM (Vinyl Chloride Monomer) and VCM is itself used almost exclusively in the manufacture of PVC (Polyvinyl Chloride). The EDC/VCM process is often integrated with chlorine production sites because of the issues with chlorine transportation and because the EDC/VCM/PVC chain is the largest single chlorine consumer. The European Union has 30 EDC/VCM production sites with a total VCM capacity of 5610 kt/yr.

Applied process: In the ethylene-based process, EDC is synthesised by the chlorination of ethylene (by high or low temperature direct chlorination) or by the chlorination of ethylene with HCl and oxygen (oxychlorination). Crude EDC product is washed, dried and purified with the off-gases passing to catalytic or thermal oxidation. Pure, dry EDC is thermally cracked in cracking furnaces to produce VCM and HCl, and the VCM is purified by distillation (HCl and unconverted EDC removal).

When all the HCl generated in EDC cracking is re-used in an oxychlorination section, and when no EDC or HCl is imported or exported, then the VCM unit is called a 'balanced unit'. By using both direct chlorination and oxychlorination for EDC production, balanced units achieve a high level of by-product utilisation. There are opportunities for energy recovery and re-use because of the combination of highly exothermic reactions (direct chlorination and oxychlorination) and energy users (EDC cracking, EDC and VCM separations).

Consumption / emissions: The main raw materials are ethylene, chlorine, oxygen (air) and, dependent on process configuration, energy.

VCM, as a carcinogen, is the **air** pollutant of most concern, but other potential pollutants include EDC, chlorinated hydrocarbons (e.g. carbon tetrachloride).

The main **water** pollutants are volatile and non-volatile chlorinated organic compounds (e.g. EDC), organic compounds and copper catalyst.

The EDC distillation train generates **liquid residues** containing a mixture of heavies (e.g. chlorinated cyclic or aromatic compounds including dioxin-related components (predominantly the octo-chlorodibenzofuran congener from oxychlorination) with suspended iron salts from catalysts) and lights (C_1 and C_2 chlorinated hydrocarbons).

The main **solid wastes** are spent oxychlorination catalyst, direct chlorination residues, coke from thermal cracking and spent lime (used in some plants for VCM neutralisation).

Best available techniques: In terms of **process selection** the following are BAT:

- for the overall production of EDC/VCM, BAT is the chlorination of ethylene.
- for the chlorination of ethylene, BAT can be either direct chlorination or oxychlorination.
- for direct chlorination, BAT can be either the low or high-temperature variants.
- for ethylene oxychlorination there are choices of oxidant (oxygen is BAT for new plants and can be for existing air-based plants) and reactor type (fixed and fluid bed are both BAT).
- optimise process balancing (sources and sinks of EDC/HCl) to maximise the recycle of process streams and aim for full process balancing.

Air pollutants: BAT for the main process vents is to:

- recover ethylene, EDC, VCM and other chlorinated organic compounds by direct recycling; refrigeration / condensation; absorption in solvents; or adsorption on solids.
- use thermal or catalytic oxidation to achieve off-gas concentrations (as daily averages) of: EDC + VCM $<1 \text{ mg/Nm}^3$, dioxin $<0.1 \text{ ng iTEQ/Nm}^3$, HCl $<10 \text{ mg/Nm}^3$
- recover energy and HCl from the combustion of chlorinated organic compounds
- use continuous on-line monitoring of stack emissions for O_2 and CO and periodic sampling for C_2H_4 , VCM, EDC, Cl_2 , HCl and Dioxin.

BAT for fugitives is to use techniques that achieve releases of volatile chlorinated hydrocarbons $<5 \text{ kg/h}$, EDC in working atmosphere $<2 \text{ ppm}$, and VCM in working atmosphere $<1 \text{ ppm}$.

Water pollutants: BAT for effluent pre-treatment is:

- steam, or hot air, stripping of chlorinated organic compounds to concentrations of $<1 \text{ mg/l}$, with off-gas passing to condensation and recovery, or incineration
- flocculation, settling and filtration of semi- or non-volatile chlorinated organic compounds that are adsorbed on particulates
- alkaline precipitation and settling (or electrolysis) to a copper concentration $<1 \text{ mg/l}$.

BAT for effluent final treatment is biological treatment to achieve: total chlorinated hydrocarbons 1 mg/l , total copper 1 mg/l , COD 125 mg/l (50 - 100 with dual nitrification-denitrification), dioxins 0.1 ng iTEQ/l , hexachlorobenzene + pentachlorobenzene $1 \text{ } \mu\text{g/l}$, hexachlorobutadiene $1 \text{ } \mu\text{g/l}$.

BAT for by-products (residues) is to minimise formation through the choice of catalysts and operating conditions and to maximise the re-use of by-products as feedstock.

BAT for wastes is minimisation and recycling to the process. BAT for sludge from waste water treatment and coke from EDC cracking is incineration in a dedicated or multi-purpose hazardous waste incinerator.

Illustrative Process: Toluene Diisocyanate (Chapter 13)

General information: Isocyanates, especially toluene diisocyanate (TDI), are commercially important in the production of polyurethanes (e.g. for flexible foams, plastics and paints for furniture, cars and consumer products). In 1991 the world-wide TDI production capacity was estimated at 940 kt. The 2001 European production capacity is 540 kt/year with plants in Belgium, Germany, France and Italy.

Applied process: Process steps in the manufacture of TDI are the nitration of toluene, the hydrogenation of dinitrotoluene (DNT) and phosgenation of the resulting toluene amine (TDA) in a solvent. The choice of reaction conditions during the phosgenation is important because of the reactivity of isocyanate groups and the possibility of side reactions.

Consumption / emissions: The inputs are primarily toluene and nitrating acid (to produce the intermediate DNT), hydrogen (for the hydrogenation of DNT to TDA) and phosgene (for the phosgenation of the TDA to TDI). Process solvents and catalysts are mainly re-used. The main air pollutants are organic compounds (e.g. toluene, TDA, solvents), NO_x and HCl. The main water pollutants are organic compounds (e.g. nitroaromatics) and sulphates. The hydrogenation process produces distillation residues and spent catalysts. The phosgenation unit produces distillation residues, contaminated solvents and activated carbon that are disposed of by incineration.

Best Available Techniques: The BAT process design is based on the phosgenation of toluene.

BAT for consumption and re-use:

- optimise the re-use of hydrogen chloride and of sulphuric acid (DNT manufacture)
- optimise the energy re-use of the exothermic reaction (without compromising yield optimisation) and of the waste gas incineration (e.g. recuperative incinerator).

BAT for waste gases is the treatment with scrubbers (in particular for phosgene, hydrogen chloride and VOC removal) or thermal incineration of organic compounds and nitrogen oxides. Low concentrations of organics can be treated by other techniques such as activated carbon. Nitrogen oxides can be also minimised by partial oxidation. BAT is also every equivalent combination of treatment methods. Emission concentrations (as hourly averages) associated with these techniques are: <0.5 mg/m³ phosgene, <10 mg/m³ hydrogen chloride and, for incineration, <20 mg total carbon /m³.

BAT for the waste water from nitration is:

- reduction of waste water and nitrate / nitrite emission by optimising the DNT process (waste water volume < 1 m³/t)
- maximise the re-use of process water
- removal of nitroaromatic compounds (DNT, Di/Tri-Nitrocresols) to reduce organic load (< 1 kg TOC /t DNT) and to ensure biodegradability (>80 % elimination by Zahn-Wellens test). Final biological treatment to remove COD/TOC and nitrate
- incineration (*in lieu* of waste water pre-treatment and biological treatment).

BAT for the waste water from hydrogenation is:

- removal of nitroaromatic compounds by stripping, distillation and /or extraction of effluents
- re-use of pre-treated process water. Waste water volume < 1 m³/t TDA
- Incineration (*in lieu* of waste water pre-treatment and biological treatment).

BAT for the waste water from phosgenation is:

- optimise the process to give a TOC load of <0.5 kg/t TDI prior to biological treatment.

BAT for plant safety is partial containment of the most hazardous elements of the phosgenation process or mitigation measures (e.g. steam/ammonia curtain) for accidental phosgene release.

The **Concluding remarks (Chapter 14)** of the BREF consider that the LVOC information exchange was generally very successful. A high degree of consensus was reached and there are no split views in this document. Much information was made available and there was a high degree of participation by industry and Member States. Due to the diversity of LVOC processes, the BREF does not give a very detailed examination of the whole LVOC sector but makes a good first attempt at defining BAT generically and for the chosen illustrative processes.

Key dates in the information exchange were the 1997 'Paris Workshop', the TWG kick-off meeting in April 1999 and the second TWG meeting in May 2001. Drafting of the BREF took longer than envisaged because of delays experienced by TWG members in compiling data and writing contributory reports. A first draft was issued in July 2000 and received almost 800 TWG comments - all of them electronically. This enabled much easier handling of the comments and, when subsequently annotated with EIPPCB decisions, it also provided a transparent record of how and why comments had been implemented. A second draft of the BREF was issued in December 2000 and received 700 comments.

The most significant discussion points have been the agreement of Generic BAT for air and water pollutants that is flexible enough to cover all LVOC processes and yet specific enough for permit writing purposes. This was hampered by a lack of emission / cost data and the simultaneous drafting of horizontal BREFs (most notably the BREF on 'Waste water / waste gas management / treatment in the chemical industry').

Over 150 items of technical material were submitted to the information exchange and there was a generally good spread of information over the LVOC industrial sectors. The illustrative process chapters of the BREF owe much to the reports submitted by CEFIC and their considerable efforts in co-ordinating European process reviews (often for the very first time). Other significant contributions were received from, in no order of importance, Austria, Finland, Germany, Italy, the Netherlands, Sweden and the UK.

Over 140 working documents were placed on the Members' Workspace of the EIPPCB web-site and, as of the second TWG meeting (May 2001), these documents had, in total, been accessed on over 1000 occasions. This demonstrates a highly active TWG that made good use of the electronic exchange forum provided by the Members' Workspace.

The LVOC sector uses well-established processes and the chapter on **Emerging Techniques (Chapter 15)** does not identify any imminent technological changes. There seems to be no pressing need for BREF revision but this should be reviewed in light of BREF usage (especially the Generic BAT chapter). A number of topics are recommended for consideration in future information exchanges, namely:

- Illustrative processes – priority consideration should be given to processes for the production of 2-ethyl hexanol, phenol, adipic acid and major LVOC products such as ethylbenzene, styrene and propylene oxide. It is also recommended to review coverage of the TDI process and to consider a selection methodology for illustrative processes.
- Interface with other BREFs – review the LVOC BREF for gaps / overlaps once there is a complete series of horizontal and chemical industry BREFs.
- Whole Effluent Assessment – may have greater value for LVOC waste waters.
- Emission / consumption data - collect more quantitative data and establish environmental benchmark methodologies.
- Cost data – collect more cost data and help develop a standard cost conversion method.
- Other pollutants / issues – provide more information on the topics of vibration, noise, decommissioning and accident prevention.
- Chemical strategy – consider how the BREF interfaces with the EU chemicals risk reduction strategy.
- Separate illustrative process documents – consider if the BREF is better divided into a core 'generic' document and a number of detailed 'illustrative process' documents.
- Classification system for air pollutants – the Environment DG are recommended to consider the need for a standard European classification system for air pollutants.
- Wider value of illustrative processes – consider if the 'thumbnail' process descriptions and Generic BAT need expanding to provide more information on non-illustrative processes.
- Biotechnology – is recommended as a field that warrants further research and development.
- Thresholds leak rates for the repair of fugitive losses – consideration of the different views of CEFIC and the Netherlands with a view to establishing a common approach.

The EC is launching and supporting, through its RTD programmes, a series of projects dealing with clean technologies, emerging effluent treatment and recycling technologies and management strategies. Potentially these projects could provide a useful contribution to future BREF reviews. Readers are therefore invited to inform the EIPPCB of any research results which are relevant to the scope of this document (see also the preface of this document).

PREFACE

1. Status of this document

Unless otherwise stated, references to “the Directive” in this document means the Council Directive 96/61/EC on integrated pollution prevention and control. As the Directive applies without prejudice to Community provisions on health and safety at the workplace, so does this document.

This document forms part of a series presenting the results of an exchange of information between EU Member States and industries concerned on best available technique (BAT), associated monitoring, and developments in them. It is published by the European Commission pursuant to Article 16(2) of the Directive, and must therefore be taken into account in accordance with Annex IV of the Directive when determining “best available techniques”.

2. Relevant legal obligations of the IPPC Directive and the definition of BAT

In order to help the reader understand the legal context in which this document has been drafted, some of the most relevant provisions of the IPPC Directive, including the definition of the term ‘best available techniques’, are described in this preface. This description is inevitably incomplete and is given for information only. It has no legal value and does not in any way alter or prejudice the actual provisions of the Directive.

The purpose of the Directive is to achieve integrated prevention and control of pollution arising from the activities listed in its Annex I, leading to a high level of protection of the environment as a whole. The legal basis of the Directive relates to environmental protection. Its implementation should also take account of other Community objectives such as the competitiveness of the Community’s industry thereby contributing to sustainable development.

More specifically, it provides for a permitting system for certain categories of industrial installations requiring both operators and regulators to take an integrated, overall look at the polluting and consuming potential of the installation. The overall aim of such an integrated approach must be to improve the management and control of industrial processes so as to ensure a high level of protection for the environment as a whole. Central to this approach is the general principle given in Article 3 that operators should take all appropriate preventative measures against pollution, in particular through the application of best available techniques enabling them to improve their environmental performance.

The term ‘best available techniques’ is defined in Article 2(11) of the Directive as “the most effective and advanced stage in the development of activities and their methods of operation which indicate the practical suitability of particular techniques for providing in principle the basis for emission limit values designed to prevent and, where that is not practicable, generally to reduce emissions and the impact on the environment as a whole.” Article 2(11) goes on to clarify further this definition as follows:

- “techniques” includes both the technology used and the way in which the installation is designed, built, maintained, operated and decommissioned;
- “available” techniques are those developed on a scale which allows implementation in the relevant industrial sector, under economically and technically viable conditions, taking into consideration the costs and advantages, whether or not the techniques are used or produced inside the Member State in question, as long as they are reasonably accessible to the operator;
- “best” means most effective in achieving a high general level of protection of the environment as a whole.

Furthermore, Annex IV of the Directive contains a list of “considerations to be taken into account generally or in specific cases when determining best available techniques ... bearing in mind the likely costs and benefits of a measure and the principles of precaution and prevention”. These considerations include the information published by the Commission pursuant to Article 16(2).

Competent authorities responsible for issuing permits are required to take account of the general principles set out in Article 3 when determining the conditions of the permit. These conditions must include emission limit values, supplemented or replaced where appropriate by equivalent parameters or technical measures. According to Article 9(4) of the Directive, these emission limit values, equivalent parameters and technical measures must, without prejudice to compliance with environmental quality standards, be based on the best available techniques, without prescribing the use of any technique or specific technology, but taking into account the technical characteristics of the installation concerned, its geographical location and the local environmental conditions. In all circumstances, the conditions of the permit must include provisions on the minimisation of long-distance or trans-boundary pollution and must ensure a high level of protection for the environment as a whole.

Member States have the obligation, according to Article 11 of the Directive, to ensure that competent authorities follow or are informed of developments in best available techniques.

3. Objective of this Document

Article 16(2) of the Directive requires the Commission to organise “an exchange of information between Member States and the industries concerned on best available techniques, associated monitoring and developments in them”, and to publish the results of the exchange.

The purpose of the information exchange is given in recital 25 of the Directive, which states that “the development and exchange of information at Community level about best available techniques will help to redress the technological imbalances in the Community, will promote the world-wide dissemination of limit values and techniques used in the Community and will help the Member States in the efficient implementation of this Directive.”

The Commission (Environment DG) established an information exchange forum (IEF) to assist the work under Article 16(2) and a number of technical working groups have been established under the umbrella of the IEF. Both IEF and the technical working groups include representation from Member States and industry as required in Article 16(2).

The aim of this series of documents is to reflect accurately the exchange of information which has taken place as required by Article 16(2) and to provide reference information for the permitting authority to take into account when determining permit conditions. By providing relevant information concerning best available techniques, these documents should act as valuable tools to drive environmental performance.

4. Information Sources

This document represents a summary of information collected from a number of sources, including in particular the expertise of the groups established to assist the Commission in its work, and verified by the Commission services. All contributions are gratefully acknowledged.

5. How to understand and use this document

The information provided in this document is intended to be used as an input to the determination of BAT in specific cases. When determining BAT and setting BAT-based permit conditions, account should always be taken of the overall goal to achieve a high level of protection for the environment as a whole.

The rest of the document provides the following information:

Chapter 1 provides general background information on the economics and logistics of Large Volume Organic Chemical (LVOC) sector to put the following chapters in context.

Chapter 2 considers the common activities (e.g. unit processes and unit operations) that are found in many LVOC production processes.

Chapter 3 provides brief descriptions of production processes for some of the major LVOC products and considers any special techniques that are used for their environmental issues.

Chapter 4 outlines the generic origins of air, water and waste emissions and their possible composition.

Chapter 5 describes, in a generic manner, the emission reduction and other techniques that are considered to be most relevant for determining BAT and BAT-based permit conditions. This information includes some achievable emission levels; some idea of the costs; any cross-media issues; and the extent to which the technique is applicable to the range of installations requiring IPPC permits.

Chapter 6 presents the techniques and emission / consumption levels that are considered to be generic BAT for the LVOC sector as a whole.

Chapters 7 to 13 consider, in detail, 'illustrative processes' that have been chosen to elucidate the application of BAT in the LVOC sector.

Chapter 6 and the BAT sections of Chapters 7 to 13 present the techniques, emission levels and consumption levels that are considered to be compatible with BAT in a general sense. The purpose is to provide general indications regarding the emission and consumption levels that can be considered as an appropriate reference point to assist in the determination of BAT-based permit conditions or for the establishment of general binding rules under Article 9(8). It should be stressed, however, that this document does not propose emission limit values. The determination of appropriate permit conditions will involve taking account of local, site-specific factors such as the technical characteristics of the installation concerned, its geographical location and the local environmental conditions. In the case of existing installations, the economic and technical viability of upgrading them also needs to be taken into account. Even the single objective of ensuring a high level of protection for the environment as a whole will often involve making trade-off judgements between different types of environmental impact, and these judgements will often be influenced by local considerations.

Although an attempt is made to address some of these issues, it is not possible for them to be considered fully in this document. The techniques and levels presented in Chapter 6 and the BAT sections of Chapters 7 to 13 will therefore not necessarily be appropriate for all installations. On the other hand, the obligation to ensure a high level of environmental protection including the minimisation of long-distance or trans-boundary pollution implies that permit conditions cannot be set on the basis of purely local considerations. It is therefore of the utmost importance that the information contained in this document is fully taken into account by permitting authorities.

Since the best available techniques change over time, this document will be reviewed and updated as appropriate. All comments and suggestions should be made to the European IPPC Bureau at the Institute for Prospective Technological Studies at the following address:

Edificio Expo, C/ Inca Garcilaso, s/n, E-41092 Seville, Spain

Telephone: +34 95 4488 284

Fax: +34 95 4488 426

e-mail: epiccb@jrc.es

Internet: <http://eippcb.jrc.es>

Best Available Techniques Reference Document in the Large Volume Organic Chemical Industry

EXECUTIVE SUMMARY	I
PREFACE	XXIII
SCOPE AND DOCUMENT ORGANISATION	XLI
1 BACKGROUND INFORMATION	1
2 GENERIC LVOC PRODUCTION PROCESS.....	7
2.1 Unit processes.....	8
2.1.1 Oxidation	9
2.1.2 Halogenation.....	10
2.1.3 Hydrogenation	10
2.1.4 Esterification.....	11
2.1.5 Alkylation	11
2.1.6 Sulphonation	12
2.1.7 Dehydrogenation.....	12
2.1.8 Hydrolysis.....	13
2.1.9 Reforming.....	13
2.1.10 Carbonylation	14
2.1.11 Oxyacetylation.....	14
2.1.12 Nitration.....	14
2.1.13 Dehydration	14
2.1.14 Ammonolysis.....	14
2.1.15 Condensation	15
2.1.16 Dealkylation.....	15
2.1.17 Ammoxidation	15
2.2 Unit operations.....	16
2.2.1 Absorption	17
2.2.2 Distillation	17
2.2.3 Extraction.....	18
2.2.4 Solids separation.....	19
2.2.5 Adsorption	19
2.2.6 Condensation	19
2.3 Process equipment and infrastructure	20
2.3.1 Reactors	20
2.3.2 Emission abatement	21
2.3.3 Energy supply.....	22
2.3.4 Cooling	22
2.3.5 Refrigeration	23
2.3.6 Storage and handling	23
2.3.7 Pressure relief.....	24
2.3.8 Vacuum.....	24
2.3.9 Pumps, compressors and fans	24
2.3.10 Pipes	25
2.3.11 Valves.....	25
2.3.12 Utility fluids.....	26
2.4 Management systems.....	26
3 GENERIC APPLIED PROCESSES AND TECHNIQUES.....	27
3.1 Chemical products with a process description.....	28
3.2 Lower olefins	29
3.3 Aromatics.....	31
3.4 Oxygenated compounds.....	34
3.4.1 Alcohols.....	35
3.4.2 Aldehydes	41
3.4.3 Ketones	41
3.4.4 Carboxylic acids	42

3.4.5	Esters	46
3.4.6	Acetates	46
3.4.7	Ethers	47
3.4.8	Epoxides	47
3.4.9	Anhydrides	48
3.5	Nitrogenated compounds	51
3.5.1	Amines	51
3.5.1.1	Aliphatic amines	51
3.5.1.2	Aromatic amines	52
3.5.2	Amides	53
3.5.3	Nitrous / nitro / nitrate compounds	54
3.5.4	Nitriles	55
3.5.5	Cyanates / isocyanates	55
3.5.6	Other	56
3.6	Halogenated compounds	59
3.7	Sulphur compounds	62
3.7.1	Generic issues in the production of sulphur compounds	64
3.8	Phosphorus compounds	66
3.9	Organo-metal compounds	66
4	GENERIC EMISSIONS	69
4.1	Air pollutants	69
4.1.1	Emission sources	70
4.1.2	Pollutant types	71
4.1.2.1	Volatile Organic Compounds (VOCs)	71
4.1.2.2	Particulate matter	72
4.1.2.3	Combustion gases	72
4.1.2.4	Acid gases	73
4.1.2.5	Dioxins	73
4.2	Water pollutants	73
4.2.1	Emission sources	73
4.2.2	Pollutant types	74
4.3	Wastes	75
4.3.1	Emission sources	75
4.3.2	Pollutant types	76
4.4	Factors influencing consumption and emissions	76
4.4.1	Plant boundary definition and the degree of integration	76
4.4.2	Definition of emission basis	76
4.4.3	Measurement technique	76
4.4.4	Definition of waste	77
4.4.5	Plant location	77
5	GENERIC TECHNIQUES TO CONSIDER IN THE DETERMINATION OF BAT	79
5.1	Management systems	79
5.1.1	Management commitment	80
5.1.2	Organisation and responsibility	80
5.1.3	Training	81
5.1.4	Process design and development	81
5.1.5	Industrial planning and logistics	83
5.1.6	Process control	83
5.1.7	Maintenance	84
5.1.8	Monitoring	84
5.1.9	Auditing	85
5.1.10	Cost awareness & financing	85
5.2	Pollution prevention	86
5.2.1	Source reduction	87
5.2.1.1	Product changes	89
5.2.1.2	Input material changes	89
5.2.1.3	Technology changes	89
5.2.1.4	Good operating practices	90
5.2.2	Recycling	91
5.2.3	Waste minimisation initiatives	92

5.2.4	Examples of process-integrated measures	93
5.3	Air pollutant control	99
5.3.1	Volatile Organic Compounds (VOCs).....	100
5.3.1.1	Process vents.....	100
5.3.1.2	Storage, handling and transfer	104
5.3.1.3	Fugitives	106
5.3.1.4	Intermittent Vents	113
5.3.2	Combustion gases.....	113
5.3.3	Particulate matter	114
5.3.4	Performance of air pollutant control techniques	115
5.3.5	Monitoring of air emissions.....	115
5.4	Water pollutant control.....	116
5.4.1	General prevention techniques.....	116
5.4.2	Abatement techniques.....	118
5.4.3	Monitoring of water emissions	121
5.5	Wastes.....	122
5.5.1	Waste prevention	122
5.5.2	Waste control.....	122
5.6	Heat.....	123
5.7	Vibration.....	124
5.8	Noise.....	124
5.9	Tools for the evaluation of techniques.....	125
5.10	Application of techniques to existing installations	127
6	GENERIC BAT (BEST AVAILABLE TECHNIQUES)	131
6.1	Introduction	131
6.2	Management systems.....	132
6.3	Pollution prevention and minimisation.....	133
6.4	Air pollutant control	136
6.5	Water pollutant control.....	140
6.6	Wastes and residues control.....	141
7	ILLUSTRATIVE PROCESS: LOWER OLEFINS.....	143
7.1	General information.....	143
7.1.1	Production capacity.....	144
7.1.2	Feedstocks.....	144
7.1.3	Economic factors	146
7.2	Applied processes and techniques	150
7.2.1	Catalytic cracking.....	150
7.2.2	Steam cracking.....	150
7.2.2.1	Pyrolysis section	151
7.2.2.2	Primary fractionation and compression	152
7.2.2.3	Product fractionation.....	153
7.2.3	Feedstock considerations	153
7.2.3.1	Gas.....	155
7.2.3.2	Naphtha.....	155
7.2.3.3	Gas Oil.....	156
7.2.4	Other factors affecting yields.....	157
7.2.5	Butadiene separation.....	158
7.2.6	Catalytic dehydrogenation of propane to propylene	159
7.2.7	Auxiliary chemicals and utilities	160
7.3	Consumption and emission levels.....	160
7.3.1	Factors influencing consumption and emissions.....	160
7.3.1.1	Plant boundary definition and the degree of integration	160
7.3.1.2	Feedstock issues.....	161
7.3.1.3	Scale of operation	162
7.3.1.4	Plant age.....	162
7.3.2	Air emissions	163
7.3.2.1	Furnace area (steady state operation).....	163
7.3.2.2	Furnace area (decoke operations)	164
7.3.2.3	Flaring.....	165
7.3.2.4	VOCs from point sources.....	165

7.3.2.5	Fugitive emissions.....	166
7.3.3	Water emissions.....	167
7.3.3.1	Process Water.....	167
7.3.3.2	Spent caustic.....	168
7.3.3.3	Total aqueous effluent stream.....	168
7.3.4	Solid wastes.....	169
7.3.5	Energy consumption.....	170
7.3.5.1	Overall energy consumption.....	171
7.3.5.2	Carbon dioxide emissions.....	171
7.3.5.3	Plant age.....	172
7.3.5.4	Plant size.....	172
7.3.6	Example plants.....	173
7.3.6.1	The Netherlands.....	173
7.3.6.2	Germany.....	174
7.3.6.3	Sweden.....	174
7.3.6.4	World Bank.....	175
7.4	Techniques to consider in the determination of BAT.....	175
7.4.1	Alternative processes.....	175
7.4.2	Air emissions.....	176
7.4.2.1	Gas-fired furnaces and steam-superheaters.....	177
7.4.2.2	Decoking vent gas.....	180
7.4.2.3	Flaring.....	181
7.4.2.4	Point source emissions.....	182
7.4.2.5	Fugitive emissions.....	183
7.4.2.6	Sour gas disposal.....	183
7.4.2.7	Costs.....	183
7.4.3	Water emissions.....	184
7.4.3.1	Process water.....	184
7.4.3.2	Spent caustic stream.....	184
7.4.3.3	Amine wash.....	185
7.4.3.4	Green oil.....	185
7.4.3.5	Other effluents.....	186
7.4.4	Solid wastes.....	186
7.4.5	Energy.....	186
7.4.6	Noise minimisation, atmospheric monitoring and reporting.....	187
7.5	Best Available Techniques.....	187
7.5.1	Process selection.....	187
7.5.2	Plant design.....	188
7.5.3	Process control and operation.....	189
7.5.4	Air emissions.....	189
7.5.4.1	Cracking furnaces.....	189
7.5.4.2	Decoking drum vent gas.....	190
7.5.4.3	Flaring.....	190
7.5.4.4	Point sources.....	190
7.5.4.5	Sour gas.....	191
7.5.4.6	Fugitive emissions.....	191
7.5.5	Water emissions.....	191
7.5.5.1	Process water.....	191
7.5.5.2	Spent caustic.....	191
7.5.5.3	Final treatment.....	192
7.5.6	By-products and wastes.....	192
7.6	Emerging techniques.....	192
7.6.1	Developments with conventional feedstocks.....	192
7.6.2	Developments with new feedstocks.....	194
8	ILLUSTRATIVE PROCESS: AROMATICS.....	195
8.1	General information.....	195
8.1.1	Benzene.....	195
8.1.2	Toluene.....	196
8.1.3	Xylenes.....	196
8.1.4	Cyclohexane.....	196
8.1.5	Production capacity.....	197

8.1.6	Economics.....	198
8.2	Applied processes and techniques	200
8.2.1	Benzene from pygas.....	204
8.2.2	Benzene and toluene from reformat or pygas	204
8.2.3	Benzene and para-xylene from reformat	205
8.2.4	Cyclohexane	206
8.2.5	Auxiliary chemicals	206
8.2.6	Integrated environment protection units	207
8.3	Consumption and emission levels.....	207
8.3.1	Factors influencing consumption and emissions.....	207
8.3.2	Energy and raw material consumption.....	208
8.3.3	Air emissions	209
8.3.4	Water emissions.....	210
8.3.5	Wastes.....	211
8.4	Techniques to consider in the determination of BAT	212
8.4.1	Air emissions	212
8.4.1.1	Combustion emissions	212
8.4.1.2	VOC emissions from point sources	212
8.4.1.3	Fugitive VOC emissions.....	213
8.4.2	Water emissions.....	213
8.4.3	Solid wastes	215
8.4.4	Process specific techniques.....	215
8.4.4.1	Pygas plants	215
8.4.4.2	Toluene hydrodealkylation (HDA)	216
8.4.4.3	Reformat plants.....	217
8.4.4.4	Cyclohexane plants	217
8.5	Best Available Techniques	218
8.5.1	Process selection.....	218
8.5.2	Air emissions	218
8.5.3	Water emissions.....	219
8.5.4	Wastes.....	219
8.6	Emerging techniques	219
9	ILLUSTRATIVE PROCESS: ETHYLENE OXIDE & ETHYLENE GLYCOLS.....	221
9.1	General information.....	221
9.1.1	Production capacity.....	222
9.1.2	Economic factors	222
9.2	Applied processes and techniques	224
9.2.1	Process chemistry	224
9.2.2	Production sequence	225
9.2.2.1	EO reaction, EO recovery and carbon removal	226
9.2.2.2	Non condensables removal and EO purification.....	228
9.2.2.3	Glycols reaction and de-watering	228
9.2.2.4	Glycols purification	228
9.2.3	Associated equipment and chemicals	228
9.2.4	Other production routes	229
9.2.4.1	Ethylene oxide	229
9.2.4.2	Ethylene glycols.....	229
9.3	Consumption and emission levels.....	230
9.3.1	Raw material and energy consumption.....	230
9.3.1.1	Influence of catalyst selectivity.....	230
9.3.1.2	Raw materials consumption.....	232
9.3.1.3	Energy consumption	232
9.3.2	Air emissions	233
9.3.2.1	Vent from carbon dioxide removal unit.....	233
9.3.2.2	Inerts vent	234
9.3.2.3	VOCs from cooling towers	234
9.3.2.4	Scrubber off-gas.....	234
9.3.2.5	Storage tanks.....	234
9.3.2.6	Fugitive / non-channelled emissions	234
9.3.3	Water emissions.....	235
9.3.4	By-products and wastes	235

9.3.5	Example plants	235
9.4	Techniques to consider in the determination of BAT	237
9.4.1	Process design principles.....	237
9.4.1.1	Ethylene oxide production process.....	237
9.4.1.2	Ethylene glycol production process.....	238
9.4.1.3	Storage facilities	238
9.4.1.4	EO loading facilities.....	238
9.4.2	Raw material consumption	238
9.4.3	Utilities consumption	239
9.4.4	Air emissions.....	239
9.4.4.1	Carbon dioxide vent	239
9.4.4.2	Inerts vent.....	240
9.4.4.3	VOC from open cooling towers	240
9.4.4.4	VOC from scrubbing EO off gases	241
9.4.4.5	Fugitive emissions.....	241
9.4.4.6	Storage.....	242
9.4.5	Water emissions	242
9.4.5.1	Liquid effluent from EO recovery section.....	242
9.4.5.2	Water bleed	242
9.4.6	Wastes	243
9.4.6.1	Spent catalyst.....	243
9.4.6.2	Heavy glycol liquid residues	243
9.4.6.3	Liquid residue from EO recovery section.....	243
9.5	Best Available Techniques.....	243
9.5.1	Process selection	244
9.5.2	Raw material and energy consumption	244
9.5.3	Plant design	244
9.5.4	Air emissions.....	245
9.5.5	Water emissions	246
9.5.6	By-products and wastes.....	246
9.6	Emerging Technologies.....	246
10	ILLUSTRATIVE PROCESS: FORMALDEHYDE	247
10.1	General information	247
10.2	Applied processes and techniques.....	248
10.2.1	Silver process (with total methanol conversion)	249
10.2.1.1	Methanol vaporisation.....	249
10.2.1.2	Catalytic methanol conversion	249
10.2.1.3	Formaldehyde absorption	250
10.2.1.4	Emission control.....	250
10.2.2	Silver process (with partial methanol conversion)	250
10.2.3	Oxide process	251
10.2.3.1	Methanol vaporisation.....	251
10.2.3.2	Catalytic conversion of methanol to formaldehyde.....	252
10.2.3.3	Formaldehyde absorption	252
10.2.3.4	Catalytic incineration of emissions	252
10.3	Consumption and emission levels.....	253
10.3.1	Raw materials and energy	253
10.3.2	Air emissions.....	253
10.3.3	Water emissions	257
10.3.4	Wastes	257
10.4	Techniques to consider in the determination of BAT	257
10.4.1	Process route	257
10.4.2	Equipment design	258
10.4.3	Raw materials consumption	259
10.4.4	Utilities consumption	259
10.4.5	Air emissions.....	259
10.4.5.1	Reaction off-gas	259
10.4.5.2	Storage tanks	260
10.4.5.3	Fugitive emissions.....	261
10.4.5.4	Other channelled vents	261
10.4.5.5	Costs.....	262

10.4.6	Water emissions	262
10.4.7	By-products and wastes	262
10.4.7.1	Waste catalyst	262
10.4.7.2	Solid para-formaldehyde by-product	263
10.5	Best Available Techniques	263
10.5.1	Process selection	263
10.5.2	Consumption of energy and raw materials	263
10.5.3	Air emissions	264
10.5.4	Water emissions	265
10.5.5	By-products and wastes	265
10.6	Emerging techniques	265
11	ILLUSTRATIVE PROCESS: ACRYLONITRILE	267
11.1	General information	267
11.2	Applied processes and techniques	269
11.2.1	Raw materials	270
11.2.2	Reaction	270
11.2.3	Quench system	271
11.2.4	Ammonium sulphate unit	272
11.2.5	Recovery section	272
11.2.6	Purification	272
11.2.7	Auxiliary chemicals	273
11.2.8	Energy aspects	273
11.3	Consumption and emission levels	273
11.3.1	Raw materials and energy consumption	273
11.3.1.1	Influencing factors	273
11.3.1.2	Consumption of raw materials	274
11.3.1.3	Consumption of energy	275
11.3.2	Gaseous streams	275
11.3.2.1	Absorber vent	275
11.3.2.2	Miscellaneous process vents	276
11.3.3	Aqueous streams	277
11.3.3.1	Quench section	277
11.3.3.2	Stripper bottoms	278
11.3.3.3	Discontinuous waste water	278
11.3.4	Co-products and wastes	278
11.3.5	Example plants	279
11.4	Techniques to consider in the determination of BAT	280
11.4.1	Process design	280
11.4.1.1	Process route	280
11.4.1.2	Co-products recovery	280
11.4.1.3	Storage and loading facilities	280
11.4.1.4	Raw materials consumption	281
11.4.1.5	Utilities consumption	281
11.4.2	Air emissions	282
11.4.2.1	Absorber vent off-gas	282
11.4.2.2	Residues incineration	283
11.4.2.3	Storage tanks	283
11.4.2.4	Miscellaneous vent streams	284
11.4.2.5	Fugitive emissions	284
11.4.3	Water emissions	284
11.4.4	Solid wastes	285
11.4.5	Liquid residues	285
11.5	Best Available Techniques	286
11.5.1	Process selection	286
11.5.2	Plant design	286
11.5.3	Air emissions	287
11.5.4	Water emissions	287
11.5.5	By-products and wastes	288
11.6	Emerging techniques	289
12	ILLUSTRATIVE PROCESS: ETHYLENE DICHLORIDE / VINYL CHLORIDE MONOMER	291

12.1	General information	291
12.2	Applied processes and techniques	293
12.2.1	Raw materials	294
12.2.2	Direct chlorination	295
12.2.3	Oxychlorination	295
12.2.4	EDC purification	296
12.2.5	EDC cracking	297
12.2.6	VCM purification	297
12.2.7	Storage and loading / un-loading	297
12.2.8	Integrated environment protection units	298
12.2.9	Auxiliary chemicals and utilities	298
12.2.10	Energy	299
12.3	Consumption and emission levels	299
12.3.1	Raw materials and energy	299
12.3.2	Air emissions	300
12.3.3	Water emissions	303
12.3.4	Liquid residues	305
12.3.5	Solid wastes	305
12.4	Techniques to consider in the determination of BAT	306
12.4.1	Process design	306
12.4.1.1	Direct chlorination	306
12.4.1.2	Oxychlorination	306
12.4.1.3	Pyrolysis	307
12.4.2	Air emissions	308
12.4.2.1	Prevention	308
12.4.2.2	Recovery of chlorinated organics	309
12.4.2.3	Treatment	310
12.4.2.4	Monitoring	311
12.4.3	Water emissions	311
12.4.3.1	Monitoring	313
12.4.4	By-products and wastes	313
12.4.5	Costs of abatement	314
12.4.6	ECVM charter	315
12.4.7	OSPAR	316
12.5	Best Available Techniques	317
12.5.1	Process selection	317
12.5.2	Plant design	317
12.5.3	Treatment of air pollutants	318
12.5.4	Treatment of water pollutants	319
12.5.4.1	Pre-treatment	320
12.5.4.2	Final treatment	320
12.5.5	By-products (residues)	320
12.5.6	Wastes	321
12.6	Emerging techniques	321
12.6.1	Ethylene based production processes	321
12.6.1.1	EDC via gas phase direct chlorination of ethylene	321
12.6.1.2	Production of VCM via catalytic cracking of EDC	321
12.6.1.3	Simplified process for the VCM production	322
12.6.2	Ethane based production processes	322
12.6.3	Other developments	322
13	ILLUSTRATIVE PROCESS: TOLUENE DIISOCYANATE.....	325
13.1	General information	325
13.2	Applied processes and techniques	325
13.2.1	Nitration	325
13.2.2	Hydrogenation	327
13.2.3	Phosgenation	328
13.2.4	Process variants and alternatives	329
13.3	Consumption and emission levels	329
13.3.1	Consumption levels	330
13.3.2	Air emissions	330
13.3.2.1	Emission from central incineration	330

13.3.2.2	Emissions from non-central purification.....	330
13.3.3	Water emissions.....	331
13.3.4	Wastes.....	332
13.4	Techniques to consider in the determination of BAT.....	332
13.4.1	Process design.....	332
13.4.1.1	Process route.....	332
13.4.1.2	Storage and loading facilities.....	332
13.4.1.3	Raw materials consumption.....	333
13.4.1.4	Utilities consumption.....	333
13.4.2	Air emissions.....	334
13.4.2.1	Absorber vent off-gas.....	336
13.4.2.2	Residues incineration.....	336
13.4.2.3	Miscellaneous vent streams.....	336
13.4.2.4	Fugitive emissions.....	336
13.4.3	Water emissions.....	337
13.4.4	Wastes.....	338
13.4.5	Plant safety.....	338
13.4.5.1	Dinitrotoluene (DNT).....	338
13.4.5.2	Toluene diisocyanate (TDI).....	338
13.4.5.3	Phosgene.....	339
13.5	Best Available Techniques.....	339
13.6	Emerging techniques.....	340
14	CONCLUDING REMARKS.....	341
14.1	Review of the information exchange.....	341
14.1.1	Programme of work.....	341
14.1.2	Information sources.....	342
14.2	Recommendations for future work.....	343
14.2.1	Future illustrative processes.....	343
14.2.2	Interface with other BREFs.....	344
14.2.3	Whole effluent assessment.....	344
14.2.4	Emission and consumption data.....	344
14.2.5	Cost data.....	345
14.2.6	Other pollutants / issues.....	345
14.2.7	Interface with chemical risk reduction strategy.....	346
14.2.8	Separate illustrative process documents?.....	346
14.2.9	Classification system for air pollutants.....	346
14.2.10	The 'wider value' of illustrative processes?.....	346
14.2.11	Biotechnology.....	346
14.2.12	Thresholds for the repair of fugitive losses.....	347
14.2.13	Timing of BREF revision.....	347
15	EMERGING TECHNIQUES.....	349
15.1	Unit processes.....	349
15.2	Biotechnology.....	351
15.3	Catalyst development.....	351
	REFERENCES.....	353
	GLOSSARY OF TERMS AND ABBREVIATIONS.....	359
	ANNEX I: MEMBER STATE LVOC EMISSION LIMITS.....	360
A.	United Kingdom.....	360
B.	Germany.....	362
C.	Austria.....	368
D.	The Netherlands.....	374
E.	Sweden.....	377
	ANNEX II: LEAKING LOSSES.....	378
	ANNEX III: FLARE SYSTEMS.....	381

ANNEX IV: INCINERATORS.....	384
ANNEX V: STRATEGIES FOR INDUSTRIAL WASTE WATER TREATMENT.....	386
ANNEX VI: USE OF CATALYSTS IN INDUSTRY	389
ANNEX VII: ENVIRONMENTAL, HEALTH AND SAFETY ACTIVITIES DURING A PROCESSING PLANT PROJECT.....	391
ANNEX VIII: MEMBER STATE AIR POLLUTANT CLASSIFICATION SYSTEMS.....	397
A. Dutch classification for air emissions.....	397
B. UK categorisation of Volatile Organic Compounds.....	416

List of figures

Figure 1.1: Structure of Industrial Organic Chemistry	1
Figure 1.2: Interface between petrochemical and hydrocarbon industries.....	2
Figure 1.3: Pathways in the organic chemical industry	3
Figure 1.4: Cycle of cash cost margin in the basic petrochemicals industry	5
Figure 2.1: Schematic production of Large Volume Organic Chemicals	7
Figure 5.1: Waste minimisation techniques.....	87
Figure 5.2: Applicability of abatement techniques to VOC flow rate and concentration	103
Figure 7.1: Uses of ethylene	143
Figure 7.2: Price fluctuations of Lower Olefin feedstock and products	147
Figure 7.3: Production costs curve for ethylene	148
Figure 7.4: Ethylene and butadiene production costs trend.....	149
Figure 7.5: Typical block flow diagram for a front-end de-methaniser sequence	151
Figure 7.6: Typical cracking furnace configuration.....	152
Figure 7.7: Major profiles for a typical naphtha pyrolysis coil.....	157
Figure 7.8: Extractive distillation of butadiene with NMP.....	159
Figure 7.9: Age distribution of European crackers.....	163
Figure 7.10: Cracker energy consumption (per tonne of ethylene and high value (HV) products).....	171
Figure 7.11: Carbon dioxide emissions (per tonne of ethylene and high value (HV) products).....	172
Figure 7.12: Energy consumption and plant age	172
Figure 7.13: Energy consumption and plant size.....	172
Figure 8.1: Uses of benzene.....	195
Figure 8.2: Uses of toluene.....	196
Figure 8.3: Uses of xylenes	196
Figure 8.4: Price trend for European spot prices of benzene (1993 - 1998).....	198
Figure 8.5: Price trend for European spot prices of paraxylene (1993 - 1998).....	199
Figure 8.6: Benzene production from pygas using extractive distillation.....	204
Figure 8.7: Production of benzene and para-xylene from reformat	205
Figure 8.8: Cyclohexane production.....	206
Figure 9.1: Ethylene oxide derivatives	221
Figure 9.2: Ethylene oxide and ethylene glycol cash cost margin curve	224
Figure 9.3: Schematic ethylene oxide / ethylene glycol process with pure oxygen feed.....	226
Figure 9.4: Schematic ethylene oxide / ethylene glycol process with air feed	227
Figure 9.5: Impact of catalyst selectivity on raw material consumption	231
Figure 9.6: Impact of catalyst selectivity on carbon dioxide production.....	231
Figure 9.7: Impact of catalyst selectivity on 'heat of reaction' produced.....	232
Figure 10.1: Schematic of silver process.....	249
Figure 10.2: Schematic of partial methanol conversion in the silver process.....	251
Figure 10.3: Schematic of oxide process.....	251
Figure 11.1: Uses of acrylonitrile in Europe.....	267
Figure 11.2: Acrylonitrile demand and production capacity in the world and Europe	268
Figure 11.3: Typical production costs of acrylonitrile in 1998.....	269
Figure 11.4: Acrylonitrile cash cost margin history	269
Figure 11.5: The BP/SOHIO acrylonitrile process.....	270
Figure 12.1: Cash cost margins for EDC and VCM in Western Europe	292
Figure 12.2: Balanced production of EDC and VCM.....	294
Figure 13.1: The chemistry of TDI production.....	326
Figure 13.2: A schematic TDI production sequence.....	326
Figure 13.3: Waste gas and waste water from the manufacture of DNT	327
Figure 13.4: Waste gas and waste water from the manufacture of TDA.....	328
Figure 13.5: Waste gas and waster water from the manufacture of TDI	329
Figure 14.1: Gantt chart for the LVOC BREF work programme	341

List of tables

Table 2.1: Unit processes used in the manufacture of 140 organic compounds.....	8
Table 2.2: Unit processes used in organic chemical production	9
Table 2.3: Unit operations used in the manufacture of 140 organic compounds	16
Table 2.4: Applications of some selected separation techniques	17
Table 3.1: Lower Olefin products with European production capacities in excess of 100 kt/yr.....	29
Table 3.2: Quantification of waste water arisings from olefin processes.....	30
Table 3.3: Treatment techniques for olefin process waste waters (excluding biological treatment).....	30
Table 3.4: Aromatic products with European production capacities in excess of 100 kt/yr.....	31
Table 3.5: Quantification of waste water arisings from aromatic processes	33
Table 3.6: Non-biological treatment techniques for aromatic process waste waters.....	33
Table 3.7: Oxygenated organics with European production capacities in excess of 100 kt/yr.....	34
Table 3.8: Implementation of N ₂ O abatement options at European adipic acid plants	44
Table 3.9: Summary of the cost of N ₂ O abatement from adipic acid plants	44
Table 3.10: Quantification of waste water arisings from oxygenated processes.....	50
Table 3.11: Non-biological treatment techniques for oxygenated process waste waters	50
Table 3.12: Nitrogenated organics with European production capacities in excess of 100 kt/yr	51
Table 3.13: Quantification of waste water arisings from nitrogenated processes	58
Table 3.14: Non-biological treatment techniques for nitrogenated process waste waters.....	58
Table 3.15: Halogenated organics with European production capacities in excess of 100 kt/yr.....	59
Table 3.16: Comparison of halogenating agents	60
Table 3.17: Quantification of waste water arisings from halogenated processes.....	61
Table 3.18: Non-biological treatment techniques for halogenated process waste waters	61
Table 3.19: Key process units and releases in lead compound production	67
Table 3.20: Main process steps in the production of n-butyllithium.....	68
Table 3.21: Production of organo-magnesium compounds.....	68
Table 5.1: Benefits of pollution prevention.....	86
Table 5.2: Principles of Green Chemistry	88
Table 5.3: Practical examples of process-integrated measures for new and existing LVOC plants.....	99
Table 5.4: Examples of control techniques to treat air emissions from the LVOC industry.....	100
Table 5.5: Summary of the strengths and weaknesses of VOC control techniques	102
Table 5.6: Cost of incineration or adsorption of VOC	103
Table 5.7: Costs of incineration or adsorption with sensitivity to process duty.....	104
Table 5.8: UK Benchmark levels associated with Best Available Techniques	104
Table 5.9: Cost of VOC containment for storage and transfer.....	106
Table 5.10: Hierarchy of primary measures for minimising storage losses	106
Table 5.11: Average USEPA emission factors.....	110
Table 5.12: Cost of Nitrogen Oxide abatement.....	114
Table 5.13: Emission levels associated with BAT	115
Table 5.14: Cross-media emissions from waste water treatment plants.....	119
Table 5.15: Treatment cost of a high-organic effluent	120
Table 5.16: Treatment cost of a halogenated effluent	120
Table 5.17: Target values for external industrial noise from new and existing installations	124
Table 5.18: Comparison of installation and connection costs	128
Table 5.19: Additional capital costs to the basic costs of an environmental investment.....	128
Table 6.1: BAT-associated values for the recovery / abatement of VOCs.....	137
Table 6.2: BAT-associated values for the abatement of other LVOC air pollutants.....	138
Table 6.3: Air emission levels associated with BAT for process vents in the LVOC industry	139
Table 6.4: BAT-associated values for water emissions.....	141
Table 7.1: Location of ethylene plants in the European Union and wider Europe	145
Table 7.2: Ethylene plant investment costs for different feedstocks	146
Table 7.3: Cash costs of production for Lower Olefins - West European leader plants.....	147
Table 7.4: Product yields (as %) for different feedstocks	154
Table 7.5: Principle emissions from Lower Olefin processes	163
Table 7.6: CEFIC survey response on CO and NO _x emissions	164
Table 7.7: Effluent pollutants and their sources.....	167
Table 7.8: CEFIC survey results for total aqueous effluent before and after treatment	169
Table 7.9: Survey response on arisings of catalyst / desiccants, organic sludges and coke	170
Table 7.10: Energy consumption with different feedstocks	171
Table 7.11: Air emissions from three Dutch steam crackers in 1998.....	173

Table 7.12: Waste water emissions from three Dutch steam crackers in 1998.....	173
Table 7.13: Efficiency of central WWTP treating effluent from two Dutch crackers.....	173
Table 7.14: Emission / consumption data for German steam crackers.....	174
Table 7.15: 1998 emissions from a Swedish ethylene cracker.....	175
Table 7.16: Main air emission sources and their components.....	176
Table 7.17: Costs of NOx reduction techniques for new and retrofitted furnaces.....	179
Table 7.18: Steam cracker emission factors, investments, operating costs and abatement efficiencies ...	184
Table 7.19: BAT-associated levels for gas fired furnaces.....	190
Table 7.20: BAT-associated levels for effluent from a central waste water treatment plant.....	192
Table 8.1: European aromatic production sites.....	197
Table 8.2: Location of EU aromatics plants.....	197
Table 8.3: Aromatics cost indices 1993 - 99.....	199
Table 8.4: Typical unit operations for aromatic recovery.....	200
Table 8.5: Summary of typical processes for the production of aromatics.....	203
Table 8.6: Typical consumption and production performances from aromatics processes.....	208
Table 8.7: Emission sources and substances from various aromatics plants.....	209
Table 8.8: Combustion emissions to air from aromatics processes (in kg/t feedstock).....	209
Table 8.9: Emissions to air.....	210
Table 8.10: Emissions to water from two Dutch aromatics processes.....	211
Table 8.11: Waste arisings from two Dutch aromatics processes.....	212
Table 9.1: European ethylene oxide production sites.....	222
Table 9.2: Cash costs of production for ethylene oxide and ethylene glycols.....	223
Table 9.3: Difference between leader and laggard cash costs.....	223
Table 9.4: Raw materials consumption of ethylene oxide / ethylene glycols processes.....	232
Table 9.5: VOC arisings from ethylene oxide plants.....	233
Table 9.6: Carbon dioxide removal vent before and after treatment.....	233
Table 9.7: Inerts vent before and after treatment.....	234
Table 9.8: Emissions from ethylene oxide plants in Germany.....	236
Table 9.9: Emissions to air in 1998 from two ethylene oxide plants in The Netherlands.....	236
Table 9.10: Emissions to water in 1998 from two ethylene oxide plants in The Netherlands.....	237
Table 9.11: Efficiency of central waste water treatment plant in Dutch plant.....	237
Table 9.12: By-product / waste generation by Producer B in The Netherlands.....	237
Table 10.1: European formaldehyde production capacity.....	247
Table 10.2: Methanol contract prices in north-west Europe (DM/t).....	248
Table 10.3: Trade-off between yield, steam export and electricity consumption.....	253
Table 10.4: Waste air streams before and after treatment.....	254
Table 10.5: VOC emissions from formaldehyde storage and handling.....	255
Table 10.6: Air emissions from Dutch formaldehyde plants.....	255
Table 10.7: Emissions from a Swedish formaldehyde plant in 1998.....	255
Table 10.8: Air emissions from gas engines and steam boilers on an Austrian formaldehyde plant.....	256
Table 10.9: Review of air emission factors for formaldehyde plants.....	256
Table 10.10: Waste arisings from Dutch and German formaldehyde plants.....	257
Table 10.11: Comparison of the silver and oxide processes.....	258
Table 10.12: Occupational Exposure Limits for formaldehyde in Europe (at March 1999).....	261
Table 10.13: Costs of abatement for formaldehyde production.....	262
Table 11.1: European acrylonitrile production.....	267
Table 11.2: Reaction yields from acrylonitrile catalysts.....	274
Table 11.3: Typical raw material consumptions.....	275
Table 11.4: European absorber vent concentration ranges before and after treatment.....	276
Table 11.5: Emissions from acrylonitrile storage and handling.....	276
Table 11.6: 1999 air emissions from an acrylonitrile plant in the Netherlands.....	277
Table 11.7: European ranges for quench effluent before and after treatment.....	277
Table 11.8: European ranges for stripper bottoms effluent before and after treatment.....	278
Table 11.9: 1999 water arisings and emissions from an acrylonitrile plant in The Netherlands.....	278
Table 11.10: 1999 waste arisings from an acrylonitrile plant in The Netherlands.....	279
Table 11.11: Emission / consumption data for a German acrylonitrile plant).....	279
Table 12.1: Location of EDC/VCM plants in Western Europe.....	291
Table 12.2: Leader and laggard Cash Costs for EDC/VCM (Western Europe in 1997).....	293
Table 12.3: Typical Cost Breakdown for a 400 kt/yr VCM plant.....	293
Table 12.4: Raw material and energy consumption in European example plants.....	300
Table 12.5: Emissions to air from German EDC/VCM plants.....	301
Table 12.6: 1998 emissions to air from Italian EDC/VCM plants.....	301

Table 12.7: Emissions to air from Swedish EDC/VCM plants	301
Table 12.8: Emissions to air from a Dutch EDC/VCM plant (1998)	302
Table 12.9: Review of air emission factors for EDC/VCM plants	303
Table 12.10: Waste water from a Dutch EDC/VCM plant before and after treatment (1998)	304
Table 12.11: Effluent from German EDC/VCM plants	304
Table 12.12: Waste water from three Italian EDC/VCM plants (prior to treatment)	304
Table 12.13: Waste generation by a Dutch EDC/VCM plant	306
Table 12.14: Maximum emission levels in treated off-gas	310
Table 12.15: Performance of effluent treatment installations	313
Table 12.16: Comparison of abatement costs for EDC/VCM production	315
Table 12.17: ECVM emission limit values for air and water	316
Table 12.18: OSPAR emission limit values for air and water	316
Table 12.19: Reported achievable concentrations in effluents from some plants	316
Table 13.1: European producers of TDI in 1998	325
Table 13.2: Specific emission from the TDI process prior to biological treatment	331
Table 13.3: Achievable releases from new TDI processes	336

SCOPE AND DOCUMENT ORGANISATION

The exchange of information on processes for the production of Large Volume Organic Chemicals (LVOC) has presented particular challenges to the TWG. This chapter therefore clarifies some of the rationale behind the BREF and explains how the document can be used.

The chemical industry is generally recognised to be a complex industrial sector with an incredible number and diversity of products. Some 70000 chemical compounds are manufactured world-wide, and each has a distinct chemical nature, production route(s) and end-use. In organic chemistry it has been estimated that there exist more than 16 million organic compounds, despite the limited number of elements involved [CITEPA, 1997 #47].

The variety and complexity of the chemical industry makes it unworkable to undertake a BAT information exchange for each separate chemical process (or product). Similar or linked processes/products were therefore grouped into generic families to provide manageable sections for the purpose of writing BREFs. The chemical industry was divided into the organic and inorganic sectors. The organic chemical industry was then further divided into three sub-groups – ‘Large Volume Organic Chemicals’, ‘Polymers’, and ‘Fine Organics’ – each the subject of a BREF. The LVOC BREF, together with other BREFs in the series, are intended to cover the following principal activities that are described in Annex 1 to Council Directive 96/61/EC:

“ Production within the meaning of the categories of activities contained in this section means the production on an industrial scale by chemical processing of substances or groups of substances listed in Sections...

4.1 Chemical installations for the production of basic organic chemicals, such as:

- a) simple hydrocarbons (linear or cyclic, saturated or unsaturated, aliphatic or aromatic)*
- b) oxygen-containing hydrocarbons such as alcohols, aldehydes, ketones, carboxylic acids, esters, acetates, ethers, peroxides,*
- c) sulphurous hydrocarbons*
- d) nitrogenous hydrocarbons such as amines, amides, nitrous compounds, nitro compounds or nitrate compounds, nitriles, cyanates, isocyanates*
- e) phosphorus-containing hydrocarbons*
- f) halogenic hydrocarbons*
- g) organo-metallic compounds.”*

The term ‘Large Volume Organic Chemicals’ does not appear in the IPPC directive and the directive does not include any threshold production levels to define the term ‘large’. It has been suggested that ‘large’ could refer to a production rate of 20 kt/yr [SEPA, 2000 #76] or 100 kt/yr [UBA (Germany), 2000 #92] [InfoMil, 2000 #83]. In Europe, a threshold of 100 kt/yr would classify some 90 organic chemicals as being ‘Large Volume’.

Generally, LVOC processes are considered to have the following features [InfoMil, 2000 #83]:

- the products are rarely consumer products in their own right, but are basic chemicals that are used in large quantities as raw materials in the synthesis of other chemicals
- production takes place in continuously operated plants
- products are not produced in a range of formulations or compositions (grades)
- products have relatively low added value
- the product specifications are defined to allow a wide range of applications (as compared, for example, with ‘fine’ chemicals).

BREF Structure: Since the scope of LVOC is so large, this BREF contains a mixture of generic information and detailed information that is presented in three tiers:

- **Tier A:** General principles of management systems, unit processes, unit operations and infrastructure that are valid for all LVOC production processes.
- **Tier B:** The category of LVOC has been divided into sub-sectors on the basis of generic product groups that are linked by common chemistry or production techniques. For each of the sub-sectors there is a description of key processes, their environmental issues and appropriate techniques for pollution prevention / control.
- **Tier C:** Specific information on a small number of selected ‘illustrative processes’ to demonstrate the application of BAT. These illustrative processes have been chosen according to two main criteria. Firstly, that the process is of major industrial importance. In general, the largest volume chemicals have been selected as illustrative processes because these usually represent the greatest number of plants and this ensures a good spread across Member States. Secondly, the illustrative processes have environmental issues where information exchange is particularly valuable for operators and regulators. On the basis of these criteria the TWG selected the following illustrative processes:

SUB-SECTOR	ILLUSTRATIVE PROCESS
Lower Olefins	Lower olefins by the cracking process
Aromatics	Aromatics: benzene / toluene / xylene (BTX)
Oxygenated compounds	Ethylene oxide & ethylene glycols Formaldehyde
Nitrogenated compounds	Acrylonitrile Toluene diisocyanate
Halogenated compounds	Ethylene dichloride (EDC) & vinyl chloride monomer (VCM)
Sulphur compounds	None
Phosphorus compounds	None
Organo-metal compounds	None

The number and choice of illustrative processes has been a balancing act between illustrating some key issues of the sub-sectors and the logistics of BREF preparation. A technical case can be made for including more and different illustrative processes, and any selection will always be open to debate. However, the chosen illustrative processes are considered to meet the criteria of industrial and environmental importance.

The translation of the planned structure into the actual BREF is shown below.

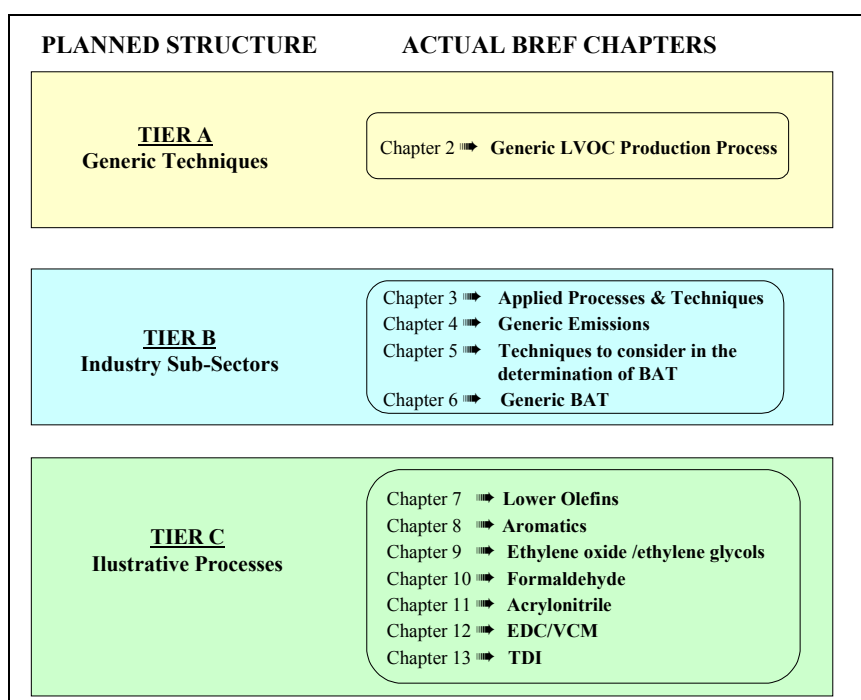

Users of the BREF should find that moving from Tier A to Tier C of the BREF provides an increasing level of detail and a trend from qualitative to quantitative information. A detailed description of BAT, and associated emission / consumption levels, is only presented for those processes described at Tier C, although Tier B (at Chapter 6) gives generic BAT for the sector.

When considering permit conditions for one of the illustrative processes, Tier C provides very specific information on production techniques, emission levels, control techniques and BAT. When permitting any other processes, then the information in Tiers A and B provides a toolkit of principles that can be used to formulate permit conditions that are synonymous with pollution prevention and control. In all cases, permit conditions will need to consider the BREF taking into account the technical characteristics of the installation concerned, its geographical location, the local environmental conditions and trans-boundary pollution.

Interface with other BREFs: There are other BREFs in the planned series that may need to be read in conjunction with this BREF in order to determine BAT for LVOC processes. The relevant BREFs include ‘horizontal BREFs’ (that cover issues common to many industrial sectors) and vertical BREFs for related processes. At the time of writing, there are plans to prepare BREFs on the following topics that may be pertinent to the LVOC sector:

- common waste water and waste gas treatment/management systems in the chemical industry
- emissions from storage
- cooling systems
- monitoring of emissions
- cross media and economic factors
- combustion plants
- waste incineration
- waste recovery / disposal.

The LVOC BREF aims to minimise any overlaps with horizontal BREFs, but may cover horizontal topics in a greater level of detail. Horizontal BREFs are cited in the LVOC BREF for the sake of completeness / understanding and to alert readers to the existence of complementary information. If no specific information is given in the LVOC BREF, then it is to be presumed that the general information in horizontal BREFs prevails.

Cost data. The comparability of cost data for production units and pollution control techniques is complicated by such factors as the year of construction, the local conditions, and the scope of work. All cost data in this BREF are reported in the currencies and dates that were quoted in the originating text. No attempt has been made to standardise cost data to one currency or to discount to a common date. This complicates the comparison of cost data but the decision has been taken in the absence of an agreed method for cost standardisation. This shortcoming is highlighted in Chapter 14 as an area for further work.

1 BACKGROUND INFORMATION

This brief introductory chapter provides general information about the LVOC industry in terms of its integration with the upstream and downstream chemical processes, macro-economics and some the main factors that affect the sector.

Industrial organic chemistry is characterised by the production of a huge variety of compounds in a step-wise manner from a few natural sources of carbon. This production pyramid is shown schematically in Figure 1.1 using typical chemical industry nomenclature.

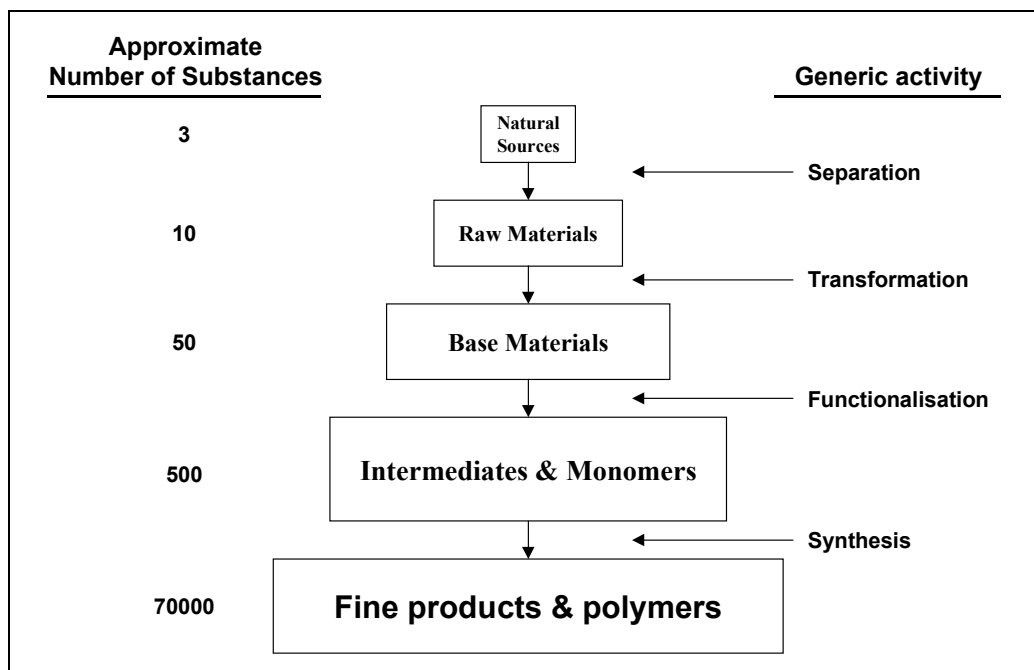

Figure 1.1: Structure of Industrial Organic Chemistry
Based on figure by Griesbaum in [CITEPA, 1997 #47]

The initial separation steps are carried out in refineries where a few **natural sources** of carbon (crude oil, natural gas and coal) are used to produce a limited number of high volume **raw materials** for the chemical industry (e.g. naphtha). Some 95 % of organic products are today obtained from oil and gas. Relatively few organic products come from the (declining) coal route and the (expanding) area of renewable biomass.

Refineries export these raw materials to petrochemical plants where they are transformed by a complex combination of physical and chemical operations into a variety of **base materials** (e.g. ethylene, C₃-C₄ olefins, BTX aromatics, synthesis gas and acetylene).

The base materials are subjected to further sequences of processing which introduce functional groups to produce an even greater number of **intermediates and monomers** (e.g. alcohols, aldehydes, ketones, acids, nitriles, amines, chlorides).

The intermediates are converted into in a large variety of **fine products and polymers** with high levels of functionalisation and high commercial value (e.g. solvents, detergents, plastics, dyes, and drugs).

This production pyramid covers the whole spectrum of the organic chemical industry and the distinction between the tiers is often very subtle. However, the BREF on LVOC can be generally considered as covering the middle three tiers of the pyramid in Figure 1.1 (i.e. taking raw materials to produce base materials, intermediates and monomers). They may also be known as ‘commodity’ or ‘bulk’ chemicals.

The complexities of actual production mean that this simple delineation of 'LVOC' scope can be more complicated. The upstream interface with refining is blurred since the sectors often occupy the same site and have common products (e.g. olefins and aromatics). However, refineries produce fractions (made up of groups of hydrocarbons) that are primarily used as fuels (or fuel modifiers), whilst the petrochemical industry produces specific hydrocarbons for use as basic building blocks in the wider chemical industry. The refinery separation processes are covered by a dedicated BREF. This interface is represented schematically in Figure 1.2.

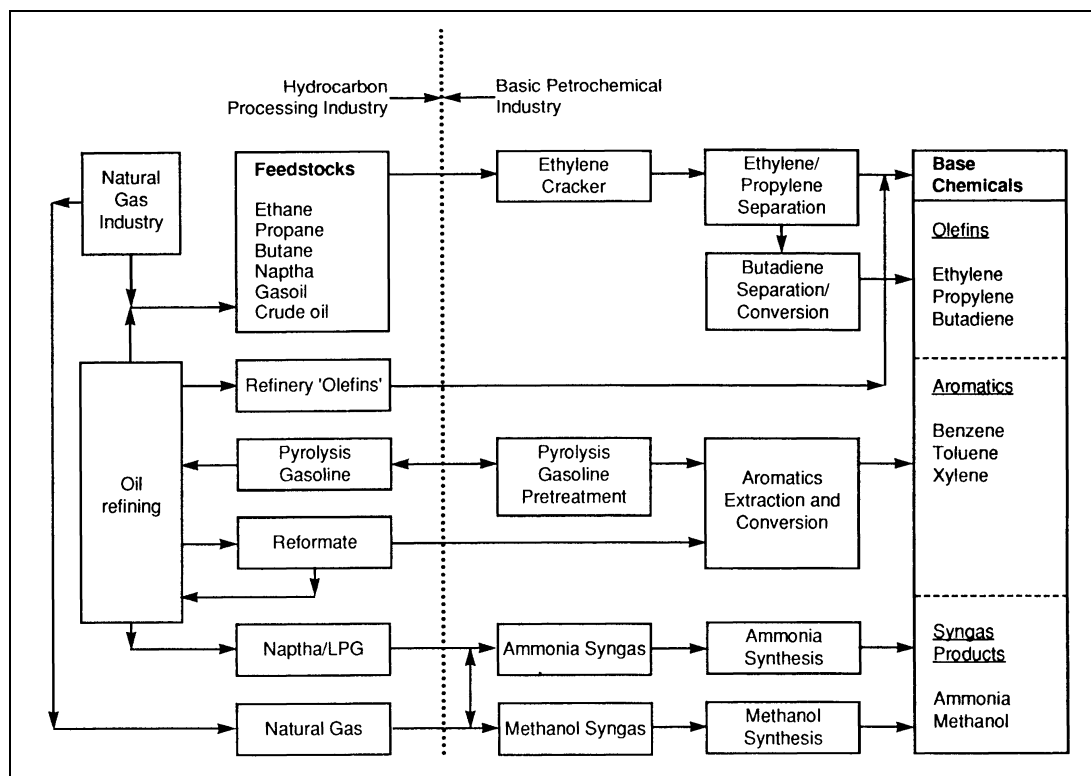

Figure 1.2: Interface between petrochemical and hydrocarbon industries
[EC DGXI, 1993 #8]

Downstream from the production of LVOC there is again integral association with the rest of the chemical industry and it is difficult to establish definitive boundaries. For the purpose of IPPC information exchange there will be separate BREFs for the production of 'Organic Fine Chemicals' and 'Polymers'.

Figure 1.3 further illustrates the complexity of the industry by showing the range of products that result from the basic hydrocarbon raw materials. Many of the products are intermediates for the rest of the chemical industry and have limited use in their own right.

As a consequence of this complex step-by-step synthesis of products, there are rarely stand-alone manufacturing units producing just one product. Instead chemical installations are usually large, highly integrated production units that combine many diverse plants. The integration of production units can confer significant economic and environmental benefits; e.g.:

- there is a high degree of process flexibility that allows operating regimes to be fine-tuned to produce chemicals in the most efficient manner
- energy use can be optimised by balancing energy sources and sinks
- by-products may be used as feedstock in other plants (e.g. crackers, furnaces, reactors) thus negating the need for disposal or allowing their use as fuel
- there are economies of scale in the treatment of waste streams and
- the loss of intermediates during transportation is reduced.

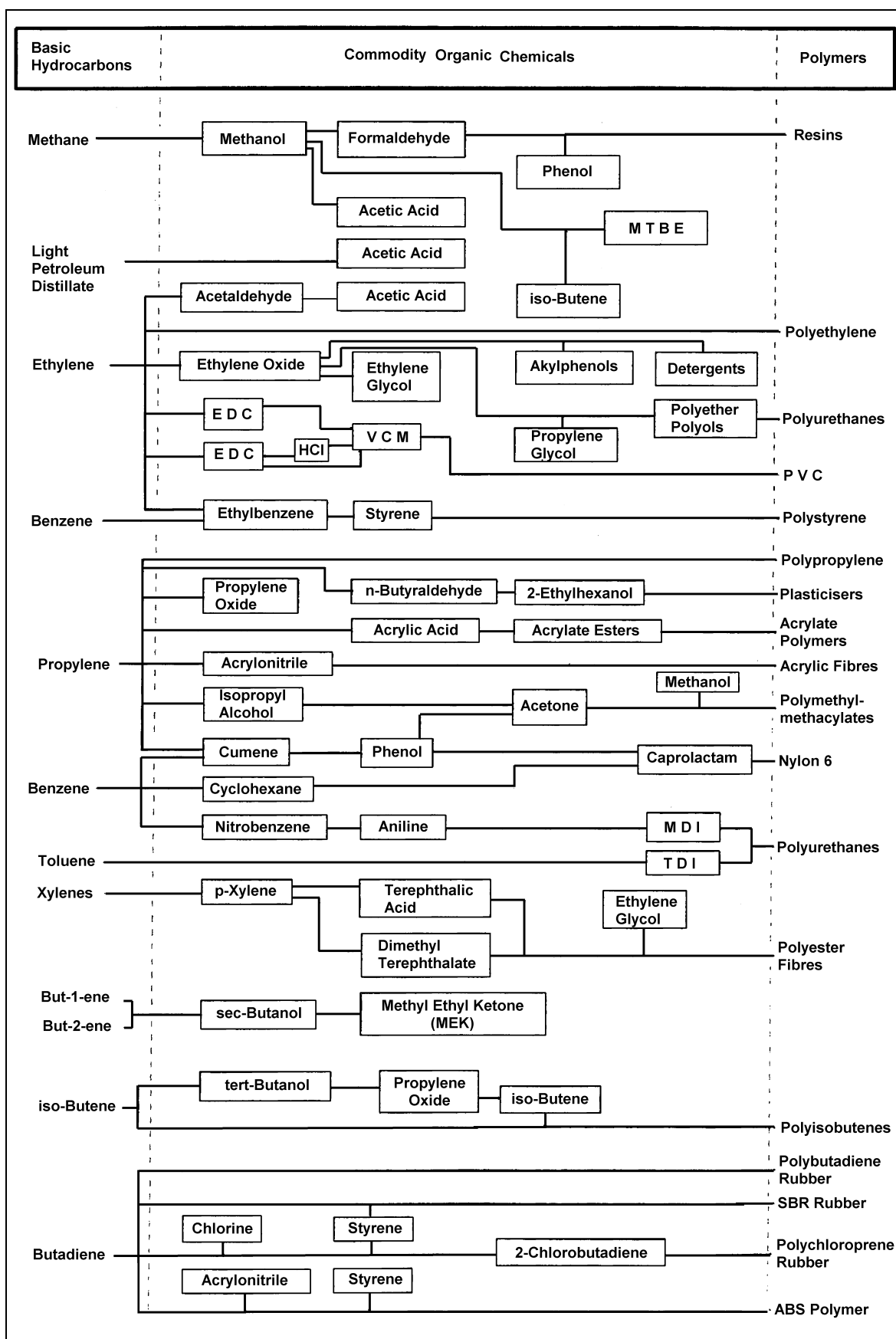

Figure 1.3: Pathways in the organic chemical industry
[EC DGXI, 1992 #23]

But integrated production sites can also create problems when it comes to the determination of BAT. Integrated production sites almost always have unique process configurations and unique operating regimes. Therefore it can be difficult to compare like-with-like because the consideration of local conditions is always such an important factor. This may be particularly pronounced in considering the environmental performance of common abatement systems, although some inter-site consistency is introduced by the common use of international technology contractors to design and build their licensed processes for LVOC producers.

Sector economics. The production of LVOC has significant economic importance in Europe. Although there are a large number of chemicals produced in Europe, the production figures are dominated by a relatively small number of chemicals manufactured by large companies. Germany is Europe's largest producer, but there are also well-established LVOC industries in The Netherlands, France, the UK, Italy, Spain and Belgium. Production in the other Member States is significantly lower. Production data for the most important chemicals within each LVOC sub-sector are given in Chapter 3.

It is difficult to provide specific economic data on the LVOC industry because there is no absolute definition of the sector and there is considerable variation in the business background to different production processes. Eurostat's Panorama database [Eurostat, 1997 #31] provides data on the general chemicals sector, with sub-set data on 'basic industrial chemicals' and further sub-set data on 'Petrochemicals'.

Global position. In overall terms, the European Union is the world's largest producer of chemical products and accounts for nearly one third of estimated world production. In financial terms, the European chemical industry in 1998 had a turnover of 441 billion Euro, of which 367 billion Euro came from EU countries. This exceeds the turnover of equivalent industries in the USA (343 billion Euro) and Japan (159 billion Euro), and compares with a world figure of 1224 billion Euro (CEFIC publication 'Facts and Figures November 99'). The European chemical market is dominated by the production of organic chemicals and their turnover is some four times the turnover generated by the production of inorganic chemicals [CEFIC, 1999 #17]. In 1995 the European Union was an exporter of basic chemicals, with the USA and EFTA countries being the main recipients. This trade balance is expected to sway towards imports as the industry faces competition from revitalised Eastern European producers, expanding Far East and Middle East capacities, and a highly organised US industry.

Competition. Basic petrochemical products are usually sold on chemical specifications, rather than brand name or performance in use. Within any region different producers have different costs of production due to variations in scale, in feedstock source and type, and in process plant. There are few possibilities for product differentiation and so economies of scale are particularly important. Like other commodities, the basic petrochemical business is therefore characterised by competition on price, with cost of production playing a very large part. The market for bulk chemicals is very competitive and market share is often considered in global terms.

Integration. Process integration is a significant factor in the economics of the primary chemical industry. The integration is both upstream (many processes are linked to refining) or downstream (many LVOC products are intermediates for associated production processes). This integration can improve the competitive position of companies, but it complicates any cost comparisons between installations. The price of LVOC is strongly determined by the economic status of downstream users and their demand, and it is generally difficult to pass price increases onto purchasers.

Profitability. The profitability of the European LVOC industry is traditionally very cyclical (see Figure 1.4). To some extent this cyclical nature reflects the normal cycles of commercial demand. However, the cycle is accentuated by the high capital investment costs of installing new technology and operators only tend to invest in additional capacity when their cash flow is good. Projects to increase capacity have long lead times and when they come on-line they

produce over-capacity that temporarily depresses margins [Environment Agency (E&W), 1999 #7]. As a result, reductions in manufacturing costs tend to be incremental and many installations are relatively old.

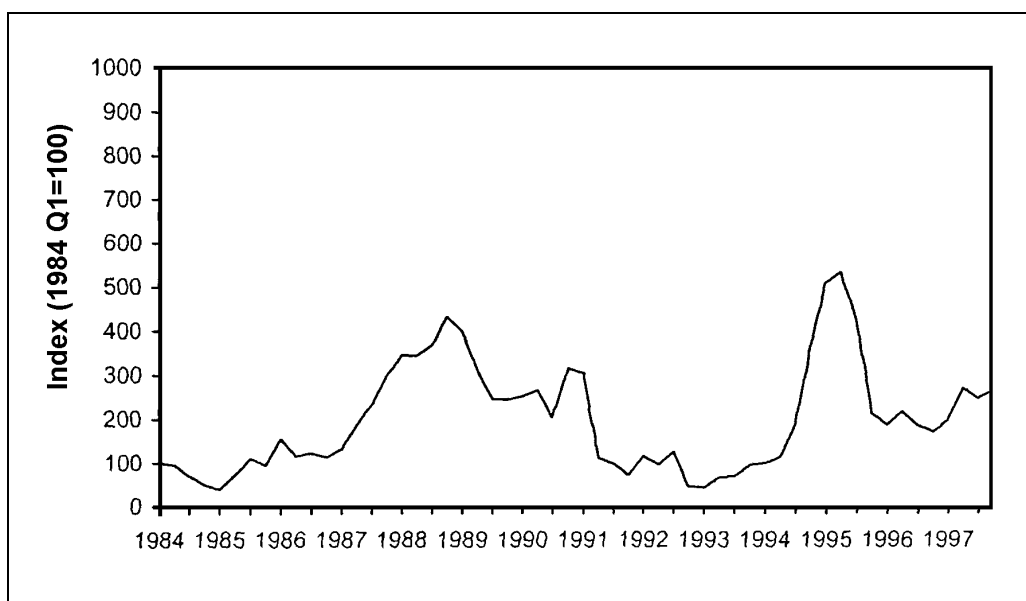

Figure 1.4: Cycle of cash cost margin in the basic petrochemicals industry
[Environment Agency (E&W), 1998 #1]

The LVOC industry is also highly energy intensive and profitability is therefore strongly linked to oil prices. The further downstream a process is from basic hydrocarbons, then the more attenuated the effects of the petrochemical cycle.

Trends. There was low demand for products in the periods 1986 - 87 and 1990 - 91, due to the general state of the European economy, and the growth of chemical production was very low. The ensuing period has seen a stronger demand for products and a tendency for major chemical companies to create strategic alliances and joint ventures. This has produced rationalisation in research, production and access to markets, and an accompanying increase in profitability.

Employment in the chemicals sector continues to decline and dropped by some 23 % in the ten-year period from 1985 to 1995. In 1995 there was a further drop of 3.8 % [Eurostat, 1997 #31]. In 1998, a total 1677000 staff were employed in the EU chemicals sector (CEFIC publication 'Facts and Figures November 99').

2 GENERIC LVOC PRODUCTION PROCESS

Although processes for the production of LVOC are extremely diverse and complex, they are typically composed of a combination of simpler activities and equipment that are based on similar scientific principles. The common activities, equipment and principles are combined and modified to create the chemical process for production of the desired product. Some of the common activities have already been recognised through the preparation of horizontal BREFs (e.g. for cooling systems, bulk storage), but there are yet more common themes that warrant one description in this BREF.

The core activity of a chemical production process is the conversion of raw materials into the desired product(s) using the necessary chemical reactions (**Unit Processes**) and physical changes (**Unit Operations**). This typically involves the five steps described below and shown schematically in Figure 2.1.

- **1. Raw material supply and preparation.** The receipt and storage of raw materials and ancillary reagents, and their charging into reactors.
- **2. Synthesis.** The core of every process where raw materials are transformed into crude product by means of a chemical reaction ('Unit Processes'), often with the aid of a catalyst.
- **3. Product separation and refinement.** Using 'Unit Operations', the product is separated from other reaction components (e.g. unreacted feed, by-products, solvents and catalysts) and purified of contaminants to the necessary specification.
- **4. Product handling and storage.** The storage, packaging and export of the product.
- **5. Emission abatement.** The collection, re-use, treatment and disposal of unwanted liquids, gases and solids for those pollutants that have not been addressed by process-integrated measures.

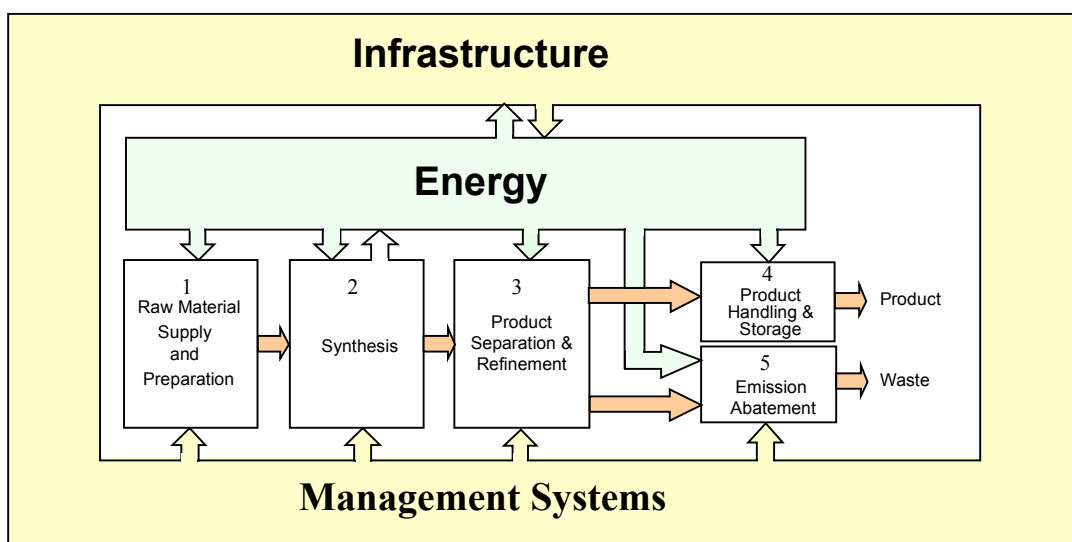

Figure 2.1: Schematic production of Large Volume Organic Chemicals
Adapted from [CEFIC, 1999 #17]

Operators aim to achieve the process steps effectively and efficiently so that profits are maximised and yet without detriment to the environment or to employee health and safety. These aims are achieved by the use of many complementary facilities and activities, namely:

- a comprehensive **infrastructure** that interconnects the units (e.g. refrigeration, vacuum, safety facilities)
- an **energy** system that produces steam or electrical energy for use in the process, and cooling facilities (where needed)
- a **management system** that ensures the operation of the process under all scenarios. This can be viewed as the software to make all the hardware work.

Since this BREF does not provide a comprehensive description of all LVOC processes, it is important to understand the generic principles of unit processes, unit operations, site infrastructure, energy control and management systems. This ‘tool-kit’ of fundamentals then enables a basic understanding of any LVOC production process; its potential environmental impacts; and suitable techniques for preventing and controlling emissions. The following sections therefore describe, in a generic manner, the main features of these fundamentals as applied to the production of LVOC. Fuller descriptions can be found in a standard text such as Ullmann’s Encyclopaedia of Industrial Chemistry [Ullmann, 1998 #80].

2.1 Unit processes

There are some 35 different types of chemical reaction that are used to produce LVOC [USEPA, 1993 #33]. Some reactions (e.g. oxyhalogenation) are specific to one or two products, whilst others (e.g. oxidation, halogenation, hydrogenation) are used widely in many processes. For this reason the majority of emissions from the production of LVOC originate from a relatively few, but commonly used, unit processes (see Table 2.1).

Unit process	Number of products produced using the unit process	Number of production activities using the unit process	Estimated contribution to total unit process air emissions prior to treatment (%)
Oxidation	63	43	48.3
Halogenation	67	43	14.5
Hydrogenation	26	13	10.8
Esterification	24	8	6.9
Alkylation	15	5	4.0
Sulphonation	11	6	3.4
Dehydrogenation	15	4	2.7
Hydrolysis	27	8	2.4
Reforming	1	1	2.2
Carbonylation	10	8	1.2
Oxyacetylation	1	2	1.0
Nitration	12	1	0.8
Dehydration	18	4	0.7
Ammonolysis	11	6	0.6
Condensation	51	4	0.5
Dealkylation	4	1	0

Note 1: The table was prepared in 1980 and no newer data was available from USEPA.

Note 2: The table takes no account of other environmental issues (e.g. cross media effects, energy).

**Table 2.1: Unit processes used in the manufacture of 140 organic compounds
USEPA as reported in [CEFIC, 1999 #17]**

Table 2.2 provides an overview of some important features of the most environmentally important unit processes. This is followed by brief descriptions of the main Unit Processes with generic consideration of their potential environmental impacts.

Process	Feed material		Conditions		Products
	Reagents	Substrates	Catalysis	Phase	
Oxidation	Oxygen (Air)	Paraffins, Olefins, BTX-Aromatics	Heterogeneous	Gas	Acids, Anhydrides, Epoxides
			Homogeneous	Gas-Liquid	Alcohols, Aldehydes, Ketones, Acids
			None	Gas-Liquid	Hydroperoxides
Amoxidation	Oxygen, NH ₃	Olefins, Alkyl-aromatics	Heterogeneous	Gas	Nitriles
Chlorination	Chlorine	Olefins, Aromatics,	Homogeneous	Gas-Liquid	Chloro-organics
		Olefins, Paraffins	None		
Hydrogenation	Hydrogen	CO, Aldehydes, Nitriles, Nitro-compound	Heterogeneous	Gas	Alcohols, Amines
Hydroformylation (Oxo-Synthesis)	H ₂ , CO	Olefins	Homogeneous	Gas-Liquid	Aldehydes, Alcohols
Dehydrogenation	-	Paraffins, Olefins, Alkyl-aromatics, Alcohols	Heterogeneous	Gas	Olefins, Diolefins, Aromatics, Aldehydes, Ketones
Alkylation	Olefins, alcohols, chloro-organics	Aromatics	Heterogeneous	Gas	Alkyl-aromatics
			Homogeneous	Gas-Liquid	Alkyl-aromatics

Table 2.2: Unit processes used in organic chemical production
Griesbaum in [CITEPA, 1997 #47]

2.1.1 Oxidation

The term oxidation includes many different processes, but in general it describes the addition of one or more oxygen atoms to a compound. Atmospheric oxygen is by far the most important, and the cheapest, oxidising agent although the inert nitrogen component will dilute products and generate waste gas streams. Other oxidising agents include nitric acid, sulphuric acid, oleum, hydrogen peroxide, organic peroxides and pure oxygen. In general terms, organic materials can be oxidised either by heterolytic or homolytic reactions, or by catalytic reactions (where the oxidising agent is reduced and then re-oxidised). Heterogeneous catalysts based on noble metals play a dominant role in industrial scale oxidations and an important example is the silver catalysed gas phase reaction between ethylene and oxygen to form ethylene oxide (this is covered as an illustrative process in Chapter 9). Ethylene is still the only olefin that can be directly oxidised to its epoxide with high selectivity. Other important industrial oxidation processes are the production of acetic acid, formaldehyde (see illustrative process in Chapter 10), phenol, acrylic acid, acetone and adipic acid. Oxidation reactions are exothermic and heat can be re-used in the process to generate steam or to preheat other component streams. Fire and explosion risks exist with heterogeneously catalysed direct oxidation processes (e.g. ethylene oxide process) and reactions involving concentrated hydrogen peroxide or organic peroxides.

Environmental issues of oxidation processes

The oxidation of organic compounds produces a number of by-products (including water) and wastes from partial and complete oxidation. In the organic chemical industry, such compounds as aldehydes, ketones, acids and alcohols are often the final products of partial oxidation of hydrocarbons. Careful control of partial oxidation reactions is usually required to prevent the material from oxidising to a greater degree than desired as this produces carbon dioxide and many undesirable gaseous, liquid, or semi-solid toxic by-products [Sikdar & Howell, 1998 #101].

Air: Emissions of volatile organics can arise from losses of unreacted feed, by-products and products such as aldehydes and acids. Carbon dioxide is an omnipresent by-product in the oxidation of organic compounds since it is impossible to prevent the full oxidation of some carbon. Aldehydes, especially formaldehyde, require strict handling to minimise occupational exposure and this limits atmospheric emissions. Acid gases usually require removal from waste streams. In general terms, oxidation reactions are exothermic and they provide good opportunities for the recovery and re-use of heat.

Water: To enable biological degradation in a WWTP it will be necessary to neutralise any acidic components and to remove / destroy any chlorinated species that may inhibit biological activity.

Wastes: Oxidation reactions may produce tars and ashes. Spent catalysts.

2.1.2 Halogenation

Halogenation describes the introduction of halogen atoms into an organic molecule by addition or substitution reactions. In organic synthesis this may involve the addition of molecular halogens (e.g. Cl₂, Br₂, I₂ or F₂) or hydrohalogenation (with HCl, HBr or HF) to carbon-carbon double bonds. Substitution reactions involve replacing hydrogen atoms in olefins, paraffins or aromatics with halogen atoms. Chlorination is the most important industrial halogenation reaction. Chlorinated organic products include chlorinated aromatics, phosgene, chlorinated methanes, chlorinated ethanes and toxicity issues may demand additional control measures. The production of 1,2-dichloroethane (EDC) and vinyl chloride (VCM) are included as illustrative processes in Chapter 12. Fluorination is used almost exclusively in the manufacture of fluorocarbons.

Environmental issues of halogenation processes

Air: The treatment of waste gases first requires a distinction between acidic streams, reaction gases and neutral waste streams. Air streams from tanks, distillation columns and process vents can be collected and treated using such techniques as low temperature condensation or incineration. The treatment of acid streams is more problematic since any equipment in contact with acid gases and water must be constructed in acid-resistant materials or internally coated. The halogen content of the waste gas represents a valuable raw material and pollution control techniques offer an opportunity for its recovery and re-use (either as hydrogen-halogen or aqueous solutions). The techniques may include:

- product recovery (by vapour stripping of liquid streams followed by recycling to the process)
- scrubbing the acid gas with an easily halogenated compound (preferably a raw material used in the process)
- absorbing the acid gas in water to give aqueous acid (often followed by caustic scrubbing for environmental protection)
- washing out organic constituents with organic solvents
- condensing out organic by-products for use as feedstock in another process (e.g. conversion of 1,1,2 trichloroethane to 1,1 dichloroethylene).

Water: There are also significant issues with waste water streams as the biological degradability of halogenated hydrocarbons (especially aromatics) decreases as their halogen content increases. Only chlorinated hydrocarbons with a low degree of chlorination are degradable in biological waste water treatment plants and then only if their concentration does not exceed certain levels. Waste water containing chlorinated compounds usually requires expensive preliminary purification prior to biological treatment, by stripping, extraction and adsorption (on activated carbon or polymeric resins). Waste water contamination can be substantially reduced by avoiding the water quenching of reaction gases to separate hydrogen chloride (for example in the production of chlorinated ethanes and ethylenes). Dry distillation and the use of refrigerator units will further reduce water contamination.

Wastes: Solid wastes may arise from such sources as reactor residues or spent catalyst. Incineration is a common method for destruction of the organic components, although attention must be paid to incineration conditions in order to avoid the formation of dioxins.

2.1.3 Hydrogenation

Catalytic hydrogenation refers to the addition of hydrogen to an organic molecule in the presence of a catalyst. It can involve direct addition of hydrogen to the double bond of an unsaturated molecule; amine formation by the replacement of oxygen in nitrogen containing compounds; and alcohol production by addition to aldehydes and ketones. These reactions are used to readily reduce many functional groups; often under mild conditions and with high selectivity. Hydrogenation is an exothermic reaction and the equilibrium usually lies far towards the hydrogenated product under most operating temperatures. It is used to produce a wide variety of chemicals such as cyclohexane, aniline, n-butyl alcohol, hexamethylene diamine [USEPA, 1993 #33], as well as ethyl hexanol and isocyanates such as TDI and MDI. Hydrogenation catalysts may be heterogeneous or homogeneous. Heterogeneous catalysts are solids and form a distinct phase in the gases or liquids. Many metals and metal oxides have general hydrogenation activity. Nickel, copper, cobalt, chromium, zinc, iron and the platinum group are among the elements most frequently used as commercial hydrogenation catalysts.

The general safety precautions that apply to highly flammable gases and vapours apply particularly to hydrogen. Hydrogen is combustible in air and oxygen over wider concentration limits than most other gases. Flammable mixtures in a confined space will explode if ignited by a flame or spark and special precautions are therefore necessary to prevent hydrogen gas leaks from tanks and equipment.

Environmental issues of hydrogenation processes
--

Air: VOC emissions from hydrogenation reactions are relatively small although hydrogen rich vent streams are typically abated in combustion units. The main issues with hydrogen are likely to arise from sulphur impurities in the feed raw materials or from the dust and ash by-products of the hydrogen production itself. Small quantities of sulphur compounds (e.g. SO ₂ , H ₂ S) can for example be absorbed in dilute caustic solutions or adsorbed on activated charcoal. Larger quantities would probably have to be converted to liquid or solid sulphur.
--

Water: Hydrogenation of oxygenated compounds (e.g. in aniline or TDI process) may generate water, which ends up as waste water. Specific waste water volumes from hydrogenation reactions are generally low. Hydrogenated oxo-products often show good biodegradability and low toxicity whereas aniline compounds may need measures additional to biotreatment.

Wastes: The spent catalysts are sometimes treated as wastes, sometimes reclaimed for precious metals. Hydrogenation reactions generate little or no unwanted by-products.
--

2.1.4 Esterification

Esterification typically involves the formation of esters from an organic acid and an alcohol. The most common method of esterification is the reaction of a concentrated alcohol and a concentrated carboxylic acid with the elimination of water. Only strong carboxylic acids react sufficiently quickly without a catalyst, so a strong mineral acid (such as sulphuric acid or hydrogen chloride) must usually be added to aid the reaction. Acid anhydrides are also used, e.g. in dialkyl phthalate production. The sulphonic acid group can be bound chemically to a polymeric material and so cation exchangers, such as sulphonated polystyrene, enable esterification under mild conditions. Lewis acids such as boron trifluoride can also be used. The equilibrium of the reaction can be shifted to the ester by increasing the concentration of one of the reactants, usually the alcohol. In production scale esterification the reaction mixture is refluxed until all the condensation water is formed, and the water or the ester product is continuously removed from the equilibrium by distillation. The main products from esterification reactions are dimethyl terephthalate, ethyl acrylate, methyl acrylate and ethyl acetate. They have considerable economic importance in many applications (e.g. fibres, films, adhesives and plastics). Some volatile esters are used as aromatic materials in perfumes, cosmetics and foods.

Environmental issues of esterification processes

Air: Solvent vapours can be collected and treated (e.g. by incineration, adsorption).
--

Water: Effluent generation is generally low, as water is the only by-product of esterification reactions. The choice of solid polymer based ion exchange resins avoids the need for catalyst neutralisation and the associated waste water treatment. Most esters possess low toxicity because they are easily hydrolysed on contact with water or moist air, and so the properties of the acid and alcohol components are more important.

Wastes: Waste streams can be reduced by recovering (and reusing) any organic solvents, water and alcohol components. Any wastes from waste water treatment can be incinerated (if they have with high boiling points) or recovered by distillation for re-use (for low boiling point components).
--

2.1.5 Alkylation

Alkylation is the introduction of an alkyl group into an organic compound by substitution or addition. There are six types of alkylation reaction [USEPA, 1993 #33]:

- substitution for hydrogen bound to carbon (e.g. ethylbenzene from ethylene and benzene)
- substitution for hydrogen attached to nitrogen
- substitution for hydrogen in a hydroxyl group of an alcohol or phenol
- addition to a metal to form a carbon-metal bond
- addition to a tertiary amine to form a quaternary ammonium compound
- miscellaneous additions to sulphur or silicon.

The largest use of alkylation is in refineries for the production of alkylates that are used in gasoline but this is within the scope of the Refineries BREF. Other major alkylation products include ethylbenzene, cumene, linear alkylbenzene, tetramethyl lead and tetraethyl lead. Alkylation is commonly carried out in liquid phase at temperatures higher than 200 °C at above-atmospheric pressures. Sometimes vapour phase alkylation is more effective. Alkylation agents are usually olefins, alcohols, alkyl sulphates or alkyl halides. Catalysts are HF, sulphuric acid or phosphoric acid. Higher temperatures cause the expected lowering of product specificity and increased by-product formation. Some more recent alkylation processes (e.g. for ethylbenzene and cumene) use zeolite catalysts as they can be more efficient and may have lower emissions. Lewis acids, like aluminium trichloride or boron trifluoride, may also be used as catalysts.

Environmental issues of alkylation processes
Air: Based on data for the production of ethylbenzene, cumene and linear alkylbenzene, VOC emissions from alkylation reactions tend to be low compared with other unit processes [USEPA, 1993 #33].
Waste: Alkyl halides and sulphates cause problems of waste product disposal [Sikdar & Howell, 1998 #101].

2.1.6 Sulphonation

Sulphonation is the process by which a sulphonic acid group (or corresponding salt or sulphonyl halide) is attached to a carbon atom [USEPA, 1993 #33]. It also describes the treatment of any organic compound with sulphuric acid, regardless of the products formed. It is used to produce many detergents (by sulphonating mixed linear alkyl benzenes with sulphur trioxide or oleum) and isopropyl alcohol (by the sulphonation of propylene). The most widely used sulphonating agent for linear alkylbenzenes is oleum (fuming sulphuric acid - a solution of sulphur trioxide in sulphuric acid). Sulphuric acid alone is effective in sulphonating the benzene ring, provided the acid content is above about 75 %. The excess sulphur trioxide in oleum removes the water of reaction and helps to obtain higher product yields. Separating the product sulphonates from the reaction mixture is often difficult. The mother liquor after product separation is an environmental problem, regardless of whether the product is precipitated by dilution or by salt formation upon reaction with a base [Sikdar & Howell, 1998 #101].

Environmental issues of sulphonation processes
Air: Acid vapours (largely sulphuric acid) from the reaction and quenching. Unreacted sulphonating agent arising from the use of an excess to drive the reaction. VOC emissions.
Water: Acidic waste waters from the reactor and dilute acidic wash waters (from washing the product on the filter) that will require neutralisation. Filtrate from the separation stage contaminated with unreacted raw material and acid.
Waste: Oleum is an extremely strong oxidising agent and produces tar by-products that require disposal.

2.1.7 Dehydrogenation

Dehydrogenation is the process by which hydrogen is removed from an organic compound to form a new chemical (e.g. to convert saturated into unsaturated compounds). It is used to produce aldehydes and ketones by the dehydrogenation of alcohols. Important products include acetone, cyclohexanone, methyl ethyl ketone (MEK) and styrene [USEPA, 1993 #33].

Dehydrogenation is most important in the ‘Cracking’ process, where saturated hydrocarbons are converted into olefins (see illustrative process in Chapter 7). The process is applied to appropriate hydrocarbon feedstocks (e.g. naphtha) in order to produce the very large volumes of ethylene, propylene, butenes and butadienes that are required as feeds for the chemical industry. Cracking may be achieved by catalytic or thermal process routes:

- Catalytic cracking provides a way to convert higher boiling fractions into saturated, non-linear paraffinic compounds, naphthenes and aromatics. The concentration of olefins in the product stream is very low, so this method is more useful for the preparation of fuels.
- Olefins are more widely produced by the steam cracking of petroleum fractions. A hydrocarbon stream is heated, mixed with steam and, depending on the feedstock, further heated to incipient cracking-temperatures of 600 - 650 °C. The conversion of saturated hydrocarbons to unsaturated compounds is highly endothermic, and so high energy inputs are necessary. High-temperature cracking is also used to produce pyrolysis gasoline from paraffin gases, naphthas, gas oils, or other hydrocarbons.

Environmental issues of dehydrogenation processes
Air: Large hydrogen-rich vent streams are produced and can be used as a hydrogen feed for other processes or as a fuel. Volatile hydrocarbons will be contained in purge and vent gases and will require collection and treatment (maybe combined with beneficial energy production). Sulphur dioxide emissions can originate from acid-gas incinerators. Nitrogen oxides originate from furnace operations in crackers.
Water: Quench water, dilution steam, decoking water and flare water discharges are the principal process streams that require treatment. Waste water streams with a high pollution load may require pre-treatment prior to acceptance in a biological degradation plant. Other liquid wastes such as ‘green oil’ (from acetylene conversion in the production of ethylene) can be burned to recover steam or energy.
Wastes: Examples of process wastes are caustic or amines used in sulphide scrubbing, cleaning acids, catalysts, tars, polymers, waste oils, coke and extracting agents (e.g. N-methylpyrrolidone) that cannot be recycled.

2.1.8 Hydrolysis

Hydrolysis involves the reaction of an organic with water to form two or more new substances. Hydration is the process variant where water reacts with a compound without causing its decomposition. These routes are used in the manufacture of alcohols (e.g. ethanol), glycols (e.g. ethylene glycol, propylene glycol) and propylene oxide. Ethylene glycol is covered as an illustrative process in Chapter 9).

Environmental issues of hydrolysis processes
Air: There are generally low VOC arisings from reactors [USEPA, 1993 #33].
Water: In most cases, hydrolysis and hydration products are biodegradable.

2.1.9 Reforming

Reforming is the decomposition (cracking) of hydrocarbon gases or low octane petroleum fractions by heat and pressure. This is most efficient with a catalyst, but can be achieved without. Reforming is mainly used in refineries to increase the octane number of fuels. The main reactions are the dehydrogenation of cyclohexanes to aromatic hydrocarbons, the dehydrocyclisation of certain paraffins to aromatics, and the conversion of straight chains to branched chains (isomerisation). It is also used to make synthesis gas from methane.

2.1.10 Carbonylation

Carbonylation (carboxylation) is the combination of an organic compound with carbon monoxide. It is used to make aldehydes and alcohols containing one additional carbon atom. The major products include acetic acid. Hydroformylation ('oxo' process) is a variant where olefins are reacted with carbon monoxide and hydrogen ('synthesis gas') in the presence of a cobalt or rhodium catalyst (e.g. in the production of n-butyraldehyde, iso-octyl alcohol, isodecanol) [USEPA, 1993 #33]. A description of the production of ethyl hexanol can be found in Section 3.4.1.

Environmental issues of carbonylation processes
Air: The process typically generates large volume, hot vent streams containing some VOCs in addition to CO ₂ , CO, H ₂ and other non-VOCs. Residual gas is recovered and used as fuel or flared [USEPA, 1993 #33].
Water: Heavy metals (from catalyst) to be removed from waste water prior to biological treatment.
Waste: Spent catalysts.

2.1.11 Oxyacetylation

Oxyacetylation involves the addition of oxygen and an acetyl group to an olefin to produce an unsaturated acetate ester. It is used to produce vinyl acetate from ethylene, acetic acid and oxygen.

2.1.12 Nitration

Nitration involves the replacement of a hydrogen atom (in an organic compound) with one or more nitro groups (NO₂). By-products may be unavoidable due to the high reaction temperatures and the highly oxidising environment, although many nitration reactions are carried out at low temperature for safety reasons. The nitrations can be of aliphatics (e.g. nitro-parraffins) but the nitration of aromatics is more commercially important (e.g. explosives and propellants such as nitrobenzene and nitrotoluenes). This is effected with nitric acid or, in the case of aromatic nitrations, a mixture of nitric and sulphuric acids. Nitration is used in the first step of toluene diisocyanate (TDI) production (see illustrative processes in Chapter 13).

Environmental issues of nitration processes [Sikdar & Howell, 1998 #101]
Air: Acid vapours (largely nitric or sulphuric acid) from the reaction and quenching. Unreacted nitrating agent arising from the use of an excess to drive the reaction. VOC emissions. Gas streams rich in oxides of nitrogen.
Water: Aromatic nitration may produce large quantities of waste mixed acid that requires neutralisation and disposal, or recovery (e.g. by distillation) and re-use. Products and by-products often are poorly biodegradable and toxic, so measures such as extraction or incineration of aqueous wastes are required.

2.1.13 Dehydration

Chemical dehydration is a decomposition reaction in which a new compound is formed by the expulsion of water. The major product of this process, urea, is produced by the dehydration of ammonium carbamate.

2.1.14 Ammonolysis

Ammonolysis is the process of forming amines using, as aminating agents, ammonia or primary and secondary amines. Ammonolytic reactions also include hydroammonolysis - in which amines are formed directly from carbonyl compounds using an ammonia-hydrogen mixture and a hydrogenation catalyst. The four main ammonolytic reaction types are [USEPA, 1993 #33]:

- double decomposition (the NH_3 is split into NH_2 , which becomes part of the amine, and H, which reacts with a radical that is being substituted)
- dehydration (ammonia serves as a hydrant to produce water and amines)
- simple addition (both fragments of the NH_3 molecule - NH and H - become part of the new amine)
- multiple activity (ammonia reacts with the amine products to form secondary and tertiary amines).

The major products of ammonolysis are carbamic acid, ethanolamines and alkylamines.

Environmental issues of ammonolysis processes
--

Air: Based on ethanolamine production, the VOC arisings from reactors are small, although there are waste gases associated with distillation. Off-gas containing ammonia or amines is washed or incinerated in order to avoid odour problems. Hydrogen cyanide and acetonitrile are produced in the production of acrylonitrile and the hydrogen cyanide may be recovered.

Water: Unreacted ammonia can be recovered from alkaline effluents by stripping and recycled back to the process. Ammonia remaining in the effluent can be neutralised with sulphuric acid (producing ammonium sulphate precipitate for use as fertiliser) or biologically treated. Waste waters containing impurities such as methanol and amines can be disposed of by incineration or biological treatment.
--

Wastes: Solid wastes from stripper bottoms are incinerated. Spent catalysts.

2.1.15 Condensation

Condensation is the chemical reaction in which two or more molecules combine and expel water, an alcohol or another low-molecular weight compound. Each of the reactants contributes a part of the separated compound. There is some overlap with addition reactions since the initial step in condensation is addition. Condensation is used in the production of acetic anhydride, bisphenol A, phenol, acetone [USEPA, 1993 #33] and ethyl hexanone.

Environmental issues of condensation processes

Air. Reactor emissions are generally small and are typically abated in a combustion unit. Distillation operations may be a source of emissions.
--

Water: Specific waste water volumes are generally low, effluents mainly consist of reaction water if recycling after phase separation is not possible. The effluent is composed of high-boiling components (condensation products/by-products) that often show moderate or poor biodegradability, and low-boiling components (educts) with better biodegradability.
--

2.1.16 Dealkylation

Toluene hydrodealkylation (HDA or TDH) is described in the illustrative process on Aromatics.

2.1.17 Ammoxidation

The production of acrylonitrile (see illustrative processes in Chapter 11) is an important process based on ammoxidation. The acrylonitrile process involves the gas phase oxidation of olefins with ammonia in the presence of oxygen and vanadium or molybdenum based catalysts.

2.2 Unit operations

Unit operations deal mainly with the physical transfer of energy and materials between the six possible combinations of state (i.e. gas-gas; gas-liquid; gas-solid; liquid-liquid; liquid-solid; solid-solid). Not all unit processes have widespread application and the USEPA has identified that most LVOC process emissions originate from only a few unit operations (Table 2.3).

Unit operation	Frequency of use	Estimated contribution to total unit process emissions (%)	Cumulative contribution to air emissions (%)
Absorption	475	58.1	58.1
Scrubbing/washing	543	27.9	86.0
Distillation	3651	10.4	96.4
Drying	251	3.3	99.7
Filtration	120	0.1	99.8
Extraction	110	0	99.8
Settling	24	0	99.8
Crystallisation	144	0	99.8
Other separation	384		
Quenching	146		
Evaporation	127		
Ion Exchange	120		
Dilution	71		
Mixing/blending	56		

Note 1: The table was prepared in 1980 and no newer data was available from USEPA.
 Note 2: The table takes no account of other environmental issues (e.g. cross media effects, energy).

Table 2.3: Unit operations used in the manufacture of 140 organic compounds USEPA 450380023 (1980) as reported in [CEFIC, 1999 #17]

The reactions used in the production of LVOC never achieve perfect selectivity of the target product and so there is considerable importance on unit operations to separate wastes from products. Many production processes need to separate individual substances from a homogeneous liquid mixture or to completely fractionate such mixtures into the component parts. Separation can be generically split into the following categories:

- liquid-vapour separation (by distillation, evaporation, steam/gas stripping)
- liquid-liquid separation (by extraction, decanting, centrifuging, multi-stage contacting)
- solid-liquid separation (by centrifuging, filtration, sedimentation, drying, crystallisation)
- solid-gas (by filtration)
- solid-solid separation (screening, electrostatic, gravity, flotation).

The application of unit operations in the chemical industry is determined by the physical and chemical properties of the substances that are being handled. The environmental impact of the different operations varies according to the conditions under which these operations are carried out (e.g. vacuum distillation has fewer diffuse emissions than distillation at elevated pressure, but may involve additional point source emissions to air or to water). The unit operations of separation can have an environmental impact because they are rarely 100 % effective (i.e. some product is lost with the reject stream) and they often introduce new materials that require recovery/treatment (e.g. solvent or wash water).

A summary of the application of separation techniques is provided in Table 2.4. This is followed by brief outlines of the most environmentally important unit operations together with an indication of their main environmental issues.

Technique	Separation Principle	Application
Fractional distillation	Different boiling points	Base materials, intermediates, final products
Extractive distillation	Different polarities	Unsaturates from saturates
Liquid-Liquid-extraction	Different polarities	Aromatics from non-aromatics
Molecular sieve techniques	Different diameters of molecules	n-Alkenes from branched and cyclic hydrocarbons
	Different polarisability of molecules	n-Alkenes from n-alkanes; p-xylene from m-xylene
Crystallisation	Different solubilities	Re-crystallisation for purification
	Different melting points	p-Xylene from m-xylene

Table 2.4: Applications of some selected separation techniques
Griesbaum in [CITEPA, 1997 #47]

2.2.1 Absorption

Absorption is the uptake of one substance into the inner structure of another; most typically a gas into a liquid solvent. Absorption is a unit operation not only for chemical production but also for environmental protection in the abatement of gaseous emissions (where it may be known as washing or scrubbing). The interaction of absorbed materials with the solvent can be physical or chemical in nature. In physical absorption, the gas molecules are polarised but remain otherwise unchanged. The concentration of dissolved gases in the solvent increase in proportion to the partial pressure of the gases. In chemical absorption, they are also chemically converted. Reactions and conversions between gaseous and liquid phases are much slower than those between one-phase mixtures, and so relatively large reaction volumes are required in gas absorption installations. Absorption equipment generally consists of a column with internals for heat and material exchange in which the feed gas is brought into counter-current contact with the regenerated absorbent. The internals direct the liquid and gas streams and increase the contact area between the two phases. Various designs are used, especially absorption plates, randomly poured packing and structured packing.

Environmental issues of absorption operations

Air: Purified gas is taken from the top of the column and is preferably re-used in the process. If re-use is not viable, then the gas stream may require further abatement (e.g. incineration).

Water: The absorbent loaded with the removed component (the so-called absorbate) leaves the bottom of the column and is regenerated by desorption. The solvent can be recovered (to minimise waste and reduce raw material costs). Water is often used as the solvent and the pollutants may be removed (e.g. by steam distillation, adsorption on activated carbon, extraction) to enable re-use in the process. Water that cannot be re-used is usually biologically treated. In some cases, the absorbate itself is a commercial or intermediate product (e.g. hydrochloric acid solutions from acid gas scrubbing).

2.2.2 Distillation

Distillation is the most important industrial method of phase separation. Distillation involves the partial evaporation of a liquid phase followed by condensation of the vapour. This separates the starting mixture (the feed) into two fractions with different compositions; namely a condensed vapour (the condensate or distillate) that is enriched in the more volatile components and a remaining liquid phase (the distilland) that is depleted of volatiles. Distillation can be divided into sub-categories according to [USEPA, 1993 #33]:

- operating mode (continuous or batch)
- operating pressure (vacuum, atmospheric or pressurised)
- number of distillation stages (single or multi-stage)
- introduction of inert gases (for example steam, to aid separation)
- use of additional compounds to aid separation (azeotropic and extractive distillation).

Only a limited number of separation problems may be solved by simple distillation and it is unsuitable for feeds containing components with similar boiling temperatures. Higher efficiency can be achieved by increasing the contact surface area or by contacting the liquid and vapour phases. Rectification columns provide intensive mass transfer by the repeated counter-current contacting of the vapour and liquid streams in multiple stages. Rectification columns are of the plate or packed design, and may involve more than 100 distillation steps. The internal structure provides a large mass transfer contact surface which is constantly regenerated. The mass transfer contact area is maximised by ensuring that the column packing is fully wetted. Heat is required at the bottom of a distillation column for evaporating the feed and condensation energy is needed at the top of the column. The condensation energy is often transferred into cooling water or air, and this may provide an opportunity for energy recovery.

Environmental issues of distillation operations

Distillation columns may contribute to emissions in three ways: by allowing impurities to remain in the product; through polymer formation in the still due to excessive temperature; and by inadequate condensing [Nelson, 1992 #45]:

Air: Off-gases from distillation may contain volatile organic material in the form of vapour or entrained droplets/mist, although this can be reduced by the use of additional condensing areas. Non-condensable substances (e.g. oxygen, nitrogen, carbon dioxide, low-boiling organics) are not usually cooled to their condensation temperature and will exit the condenser. Emission points from distillation are typically: the condenser, accumulator, hot wells, steam jet ejectors, vacuum pump and pressure relief valve. The total volume of gases emitted from a distillation operation depends upon [USEPA, 1993 #33]: air leaks into the column (increases with reduced pressure and increased size); volume of inert carrier gas; gases dissolved in the feed; efficiency / operation of the condenser or other recovery equipment; and physical properties of the organic constituents.

Water: Depending of the boiling point of the components, effluents may result from aqueous bottom residues or from the top after condensation. Discharges depend on the efficiency of the distillation process and of additional steps for phase separation (preferably fractionated-condensation of top effluent, stripping of bottom residues)

Wastes: Highly concentrated still bottoms are often incinerated if recovery of organic components is not possible.

2.2.3 Extraction

Extraction is the most important liquid-liquid separation process used in industrial chemistry. It is used mainly where other separation methods or direct distillation are ineffective or too expensive. Its typical uses include:

- separation of components with similar boiling points (e.g. separating aromatics from hydrocarbons)
- separation of high boilers from aqueous solution
- separation of mixtures with high boiling points
- separation of temperature sensitive compounds
- separation of azeotropic mixtures (e.g. extraction of acetic acid from aqueous media)
- separation of pollutants for the minimisation of waste water streams.

In order to extract a substance, an extraction solvent must be added to form a second liquid phase solution. Generally the desired substance is then separated from the solvent by distillation and the solvent is recycled. Sometimes the selective action of the solvent is used in combination with distillation (extractive distillation or azeotropic distillation), for example in the manufacture of very pure, light aromatics. Extraction solvents like dimethyl sulfoxide, morpholines, sulfolane and diethylene glycol are widely used in the production of aromatics. N-methyl-pyrrolidone, dimethylformamide and acetonitrile are also important solvents, especially for the extraction and separation of butenes and butadienes. Various types of mixer-settlers, centrifugal extractors and columns are used as extraction apparatus. All of them add the light phase at the bottom of the column, and the heavy phase is removed from the top. The density

difference causes the light phase to rise through the heavy phase and effect the mass transfer between the two phases.

Environmental issues of extraction operations
--

Water: The extracting agent (raffinate) is generally recycled and only a small amount of liquid waste is generated. If water is used as the solvent, then it can be biologically treated once any highly concentrated waste components have been separated. Other extracting agents may require incineration.
--

2.2.4 Solids separation

Solid-liquid and solid-gas separations have industrial importance for product finishing and for minimising emissions of particulate matter to the atmosphere. Product finishing applications include separating heterogeneous catalysts from a product stream or separating solid products, by-products or intermediates (e. g. ammonium sulphate in the acrylonitrile-process, BTX-aromatics at low temperatures). The principal solid-gas separation techniques are cyclones, fabric filters, ceramic filters, wet collection devices, electrostatic precipitators, dust separation equipment and high efficiency venturi scrubbers. The main solid-liquid techniques are centrifuging, filtration, sedimentation & clarification, drying and crystallisation. The choice of technique depends on:

- the characteristics of the particles and the carrier gas stream
- process factors such as temperature and pressure and
- operational factors such as floor space and headroom.

Environmental issues of solids separation operations

Wastes: It is often possible to re-use solids that are collected by separating devices, although often for lower grade applications.

2.2.5 Adsorption

Adsorption is the physical accumulation of material (usually a gas or liquid) on the surface of a solid adsorbent. Industrial adsorption processes are used to remove certain components from a mobile phase (e.g. air or water) or to separate mixtures. The applications can be production or abatement related and may include the removal of water from gases or the removal of organics from air streams or flue gas. The best adsorbents are characterised by a large number of different sized pores and so activated carbon, zeolites, silica gel and aluminium oxide are the most commercially important. Zeolites (molecular sieves) have a very narrow distribution of micro-pores and preferentially adsorb polar or polarisable materials (e.g. water or carbon dioxide). By contrast, activated carbon has a hydrophobic character and is especially suitable for the removal of organic substances.

Environmental issues of adsorption operations
--

Air: Off gases created by desorption during adsorbent regeneration.
--

Wastes: Spent adsorbents that can no longer be regenerated.
--

2.2.6 Condensation

Components from gaseous mixtures can be separated into liquids (or solids) by fractional condensation. Either the residual gas or the condensate may be the desired product. The temperature, the partial pressure of the condensing substances and their vapour pressure are linked. The recovery of 100 % of the condensing substances is not possible, whatever the temperature, when inerts are present with the condensing substances. Condensation may be used to separate products from waste streams and this often enables valuable feedstock or

solvent to be returned to the production process. Condensation of volatile species is also used to minimise the emission of air pollutants, but this may require the use of cryogenic condensation to achieve the desired lower emissions.

Environmental issues of condensation operations
Air: Residual components that are not condensed.
Water: Condensation generates no waste water, but the condensed products might be a waste water.
Wastes: Condensation generates no wastes, but the condensed products might be a waste.

2.3 Process equipment and infrastructure

Every LVOC production site will have a comprehensive infrastructure that interconnects the production units (see Figure 2.1). Although not directly involved with the production process, the infrastructure provides the essential hardware and services (utilities) to ensure that the process operates effectively, safely and without detriment to the environment. The following sections provide brief descriptions of the core process reactors and the supporting infrastructure.

2.3.1 Reactors

Reactors are usually the core operation of a process because they are responsible for converting the raw materials into products. There is a large range of reactor types, and designs may be very specific to a process, but they can be broadly classified by [Theodore & McGuinn, 1992 #37]:

- Mode of operation (continuous or batch) – almost without exception LVOC processes will use continuous reactors.
- Reaction phase – Unit processes may be carried out in reactors as heterogeneously catalysed reactions where gaseous reagents contact with a solid catalyst to form gaseous products. This has the advantage of avoiding a mixture of product with catalyst or solvent, but has the disadvantages that feed is often applied at high dilution and low conversions are achieved. Gas-liquid reactions are also important for the relevant unit processes, especially oxidations and chlorinations, and may be undertaken in a variety of reactors such as continuously stirred tanks, plug flow (e.g. oxidation of ethylene to ethanol) or bubble column reactors.
- Reactor geometry – the flow pattern and manner of contacting the phases. Some typical reactor configurations are:
 - fixed bed tubular (e.g. oxidation of ethylene to ethanol over an acidic catalyst)
 - fixed bed multi-tube (e.g. oxidation of ethylene to ethylene oxide over a silver catalyst)
 - fluidised bed (e.g. ammoxidation of propylene to acrylonitrile).

Reactors are typically made of steel or glass-lined carbon steel, but the actual design will take account the following factors [Theodore & McGuinn, 1992 #37]:

- chemistry (the reaction kinetics determine the residence time to achieve the necessary degree of conversion)
- mass transfer (the diffusion rate of reacting species)
- heat transfer (the removal or addition of reaction heat)
- protection of health, safety and environment (the prevention of releases by reaction control).

Under normal operating conditions there are five major sources of waste production in reactors [Smith & Petela, 1991 #46]:

- a primary reaction between feedstocks
- a secondary reaction subsequent to the primary reaction
- impurities in feedstocks
- catalyst degradation or loss during cleaning
- inability to recycle unreacted feedstock back into the reactor.

Effluents seldom originate directly from reactors and, in most cases, the main pollution load results from the unit operations of separation.

Atmospheric emissions from reactors may originate from [USEPA, 1993 #33]:

- direct reactor process vents from liquid phase reactors
- vents from recovery devices serving streams on liquid phase reactors (enables the recovery of raw materials, products and by-products)
- process vents from gas phase reactors (after either the primary or secondary product recovery device)
- exhaust gases from combustion devices applied to any of the above streams
- fugitive losses from agitator seals, circulating pump seals, safety valves, flanges, valve stem packing etc.

Reactors are served by inlets (to allow the addition of chemical reagents and inert reaction atmospheres) and outlets (for the removal of products, wastes and emergency venting). There will also be access points for measuring reaction conditions, for maintenance activities and for an agitator to provide full mixing of the reagents. These connections represent potential points of loss and hence the number should be minimised [Environment Agency (E&W), 1999 #6].

It is also usual for reactors to be served by some form of internal or external heat exchanger to effect temperature control by either heating and / or cooling. In order to dampen temperature fluctuations and minimise energy losses the reactor may be insulated.

The emptying and cleaning of reactors is a potential source of losses and these can be minimised by: reducing internal obstructions; installing the drain at the lowest point; and designing inlets that slope back into the reactor. This is complemented by operational practises such as keeping the system warm to assist draining, the use of steam cleaning and the planning of production campaigns (when used) to minimise product changes.

2.3.2 Emission abatement

Emission abatement equipment represents one of the most important parts of site infrastructure. A wide variety of end-of-pipe pollution control techniques is available for gaseous, liquid and solid wastes and many are used in common ways across the chemical industry. Rather than being described repeatedly in all the chemical industry BREFs, they are covered in dedicated documents. Detailed information on emission abatement techniques will be found mainly in the BREF titled 'Waste water and waste gas treatment / management for the chemical industry'. Pertinent information may also be found in the BREFs on 'Hazardous waste disposal/recovery' and 'Waste incineration'.

The application of emission abatement technologies is highly dependent on site specific situations and needs to be evaluated case-by-case. Where gaseous and liquid streams necessarily arise from a process (i.e. prevention techniques have been fully implemented), then the aim is to maximise the number of vents that are collected and diverted into appropriate treatment units. Many large sites make use of centralised environmental treatment facilities for waste water and waste gases (although waste gases are often harder to collect and so less suited to centralised treatment). Central treatment plants take advantage of economies of scale when installing and operating treatment equipment, and they damp hydraulic and chemical fluctuations in the effluent feeds thus improving the stability of performance. There may also be direct benefit from the combination of effluent streams (e.g. the combination of nitrogen-containing waste water streams with nitrogen-poor streams to aid their biological treatment). However, centralised treatment facilities should provide genuine benefits and not merely dilute pollutants prior to release.

The treated streams from waste water and waste gas abatement plants should be emitted in such a manner that they are satisfactorily dispersed in the receiving environment and do not cause harm. It is particularly important to ensure that vents are of adequate height in view of local meteorology, topography, adjacent buildings and releases from other vents. This BREF does not provide information on the environmental dispersion of releases and reference should be made to a standard text if further information is required.

Most abatement technologies involve some degree of pollutant transfer between the different environmental media and attention should be paid to the overall impact to ensure that problems are not transferred to other environmental compartments. There may benefit from using an integrated evaluation procedure and further discussion may be found in the horizontal BREF on 'Cross-media and economic aspects'.

2.3.3 Energy supply

Many of the reactions and separations in LVOC processes have a significant requirement for energy. The energy source depends on the process requirements and the local availability. Many operators sub-contract energy supply to third parties or use the central facilities that exist on many sites. The main sources are direct-fired process furnaces, steam boilers, power generation in turbines and heat exchange (against a hotter product or raw material). More information on combustion units such as boilers and gas turbines may be found in the BREF on Large Combustion Plant [EIPPCB, Draft #127].

Process furnaces are the primary source of heat in many endothermic chemical processes and are typically fired on gas or liquid fuels. Process furnaces are often chemical reactors and are energy consumers. Like heat exchangers they are considered as process equipment.

Steam is normally generated in steam boilers or in Combined Heat and Power (CHP) units. Energy from boilers is distributed around an installation using a heat transfer medium (usually steam, but possibly water or oil). A large chemical complex usually has steam available at several energy levels (high, medium and/or low pressure). Heat is input to the process either directly (e.g. by steam injection) or indirectly by some form of heat exchanger equipment (typically shell and tube type). The condensate from steam use will have its own collection system for return to the boiler.

Electrical power is needed for equipment such as pumps, mixers, compressors, and lighting. Power can be generated on-site or purchased but there is a trend in the chemical industry to combine power and steam generation in CHP units. CHP units fulfil the need for both steam and electricity and have a very high overall energy efficiency. They also reduce the dependence on external power supplies, and can generate excess power for the grid. CHP is most successful where the heat to power ratio is at least 1:1 and power is needed for at least 6000 hours per year [Environment Agency (E&W), 1999 #7]. However, the dependence on external power supplies increases when CHP units are built and operated by a third party.

2.3.4 Cooling

As a general rule cooling systems are only adopted when arisings of waste heat have been minimised and all opportunities for heat re-use have been exhausted. By applying such heat integration, significant energy can be saved and the associated emissions reduced. The removal of heat from exothermic processes is very important for process control and safety reasons, and cooling may also be required to create the right conditions for certain process steps (e.g. liquefaction of lower boiling compounds) [InfoMil, 2000 #83]. Nearly all LVOC installations have an extensive cooling system; most commonly using water as the cooling medium, but with

increasing use of air-cooling. For cooling below approximately 20 °C, other cooling media are normally required (e.g. ammonia, hydrocarbons, carbon dioxide).

Cooling systems typically involve some form of heat exchanger to remove heat from the process, a heat transfer medium and a mechanism for dissipating heat into the environment. A wide variety of cooling technologies is available and since these technologies are used in common ways across industry they are covered in detail in a dedicated horizontal BREF titled 'Cooling Systems'. The application of cooling systems is highly dependent on site-specific conditions and each case needs to be evaluated individually using the principles in the horizontal BREF in order to establish the cooling requirements. The main considerations are:

- potential losses of process materials which depend heavily on the effectiveness of the cooling systems used for condensation
- resource consumption (water, air, energy, chemical substances)
- emissions to water (chemicals and heat) and air, noise, plumes and waste generation
- risk aspects
- pollution arising from specific events (starts/stops) or incidents
- effects of process and equipment design, and of material and maintenance
- de-commissioning of installations.

In general, evaporative cooling towers for water are designed to ensure that condensed plumes do not reach ground level as this can cause nuisance (loss of light, reduced visibility, road icing) and contamination (with biocides or micro-organisms). Cooling circuits are also monitored for process fluid contamination using an appropriate indicator parameter (e.g. conductivity) and temperature alarms are fitted to warn of overheating.

2.3.5 Refrigeration

Refrigeration is provided where processes require temperatures below those that can be obtained with cooling water - usually by a central site facility. Chlorofluorocarbons (CFCs) or intermediate substances such as hydrochlorofluorocarbons (HCFCs) are not generally used in new refrigeration systems. The source of cooling is distributed around a site using either chilled water (for temperatures down to about 10 °C) or salt brines (down to -30 °C) [Theodore & McGuinn, 1992 #37]. Measures are taken to minimise the loss of refrigerants from pumps, pipe joints etc. Local detection systems such as LDAR may be used for detecting fugitive losses.

2.3.6 Storage and handling

Emissions may arise from the storage of raw materials, intermediates, products and wastes during routine operation or during accidents. The substances may be stored as gases, liquids or solids and the storage vessel may take various forms, for example drums, intermediate bulk containers (IBC) or tanks. Emissions may also occur while materials are being conveyed to and from storage vessels.

Just like the main process units, storage is subject to risks of over-pressurisation, leakage and equipment failure. Hazard and operability studies (HAZOP) are carried out on storage and handling facilities to provide a structured assessment of failure events and their mitigation. The detailed design of storage depends on the nature of the substance, the quantity stored and the proximity of environmental receptors. Large, integrated chemical production sites may involve lower risks of spillage because they obviate the need for the loading of transfer vessels (rail or road tankers, or boats), and their transportation and unloading at a destination. However, these sites often necessitate chemicals being pumped through long pipe networks and this introduces risks of failure on remote pipe-runs.

With regard to storage, many of the techniques for preventing emissions are used in common ways across industry. Rather than being described repeatedly in many different BREFs, they are covered in a dedicated horizontal BREF titled 'Emissions from storage' [EIPPCB, Draft #49]. The horizontal BREF should be read in conjunction with this document.

2.3.7 Pressure relief

All vessels and contained equipment are assessed to identify possible over-pressure scenarios. Initial protection may be provided by controls, alarms and trips, but it may also be necessary to provide back-up emergency pressure relief in the form of relief valves and bursting discs. The design of valves and discs considers the gas relief rates, the relief method, vent design and gas dispersion [Environment Agency (E&W), 1999 #6]. The downstream provision of collection and treatment facilities depends on the magnitude and likely impact of unhindered release. It is generally possible to route reliefs to an abatement system (e.g. a flare), or to collect reactor contents in a dump tank.

Pressure relief equipment is used relatively infrequently, but procedures and maintenance regimes exist to ensure that it operates correctly on demand. Procedures may also exist to ensure that plant modifications do not invalidate protection systems. Consideration may be given to avoiding the need for pressure reliefs by providing inherent protection against over-pressurisation [Environment Agency (E&W), 1988 #5]. It may be possible to design the system to withstand all potential sources of high pressure or to use high integrity instrumentation. Any such alternatives must be fully validated by hazard analysis to demonstrate that there is an acceptably low probability of failure.

2.3.8 Vacuum

There are many demands for reduced pressure on a typical LVOC installation. The vacuum duty depends on the quantity of gas being handled and degree of cooling / condensation in the system. Vacuum can be provided in several ways that have been summarised as follows [Environment Agency (E&W), 1999 #6]:

- **Steam jet ejectors.** These are simple, reliable and widely used, although they can be noisy. They create a low concentration effluent, but this can be minimised by using surface (rather than direct) condensers on the steam jet.
- **Liquid ring pumps.** The maximum attainable vacuum is limited by the vapour pressure of the sealing fluid. Some contaminants in the gas stream are taken up by the sealing liquid, and sealing liquid purge forms a concentrated effluent that may be recovered or treated. The process fluid can be used for sealing and this reduces effluent formation. This type of pump can be noisy.
- **Dry vacuum pumps.** These pumps do not produce an effluent as the seal is achieved by high rotation speeds of the rotary pump and close tolerances. The presence of condensable liquids or solids can cause excessive maintenance or breakdown. Dry vacuum pumps cannot be used where the process fluid is potentially explosive in normal or upset conditions.

The ingress of air through seals is a major factor in the efficiency of vacuum systems. Air ingress can be reduced by careful design, correct equipment choice and frequent maintenance. Instrumentation may be used to detect excessive flows.

2.3.9 Pumps, compressors and fans

Pumps, compressors and fans (blowers) are widely used in all installations to increase pressure and hence induce the movement of liquids or gases between equipment. There is a wide choice

of equipment, much of it developed for particular applications, but there is a general distinction between centrifugal, rotating and reciprocal types.

Pumps require seals (often a packed gland) to prevent liquid loss from the interface between the moving shaft and stationary casing, but there is a need for a low level of leakage over the sealing surfaces to provide lubrication. Mechanical seals provide lower leakage than packed glands on rotating shafts, so long as the seal is correctly aligned and not exposed to vibration [Environment Agency (E&W), 1999 #6]. Double mechanical seals provide a further level of leak prevention and rely on the pressurisation of fluid in the void between two seals. Still higher levels of protection are provided by pumps that dispense with seals (e.g. magnetic drive centrifugal, canned centrifugal, diaphragm and peristaltic), although such pumps may be less energy efficient.

Compressors have many similar features to pumps, although there are more complicated arrangements for the lubrication and cooling of the interface between the stationary and moving parts of the seal. The common types of compressor seal can be categorised as: labyrinth; restrictive ring; mechanical; liquid film and magnetic ring. The shaft sealing system will usually have a gas bleed and this may require abatement.

2.3.10 Pipes

Conduits for the transfer of gases, liquids and solids are an integral part of all production processes. Pipe design is dependent on such factors as operating pressure, temperature and corrosivity of substances, so it is very specific to each installation. Well-designed pipes rarely suffer from catastrophic failure and most losses are associated with pipe connections. Pipe connections either have the purpose of joining pipes (i.e. two pieces of straight pipe, changing pipe direction, changing pipe diameter, joining two streams) or linking ancillary process equipment (e.g. pumps, compressors, tanks, valves). These connections may be made by a variety of methods such as flanges, welding and threads. Special considerations are introduced where the pipes are lined. There is a general presumption to minimise the length of pipe runs and to minimise the number of connections. Inspection and maintenance regimes are important for minimising fugitive losses from pipes, especially where pipes occupy infrequently visited parts of an installation.

2.3.11 Valves

Valves are widely used on installations for controlling or preventing the flow of gases and liquids. The choice and design of valves is very specific to the application, although in general terms the most common valve types are gate, globe, plug and control. Valve internal parts are usually actuated externally and this necessitates an operating stem. The loss of process fluid from valves is usually prevented by the use of a packed gland seal, in a similar manner to pumps, but under the influence of heat, pressure, vibration and corrosion the packing can lose its integrity and allow leaks.

These losses can be reduced by the use of bellows or diaphragms to isolate valve actuation from the process fluids. However, bellow valves are significantly more expensive than gate valves and their size may pose piping layout problems. Likewise, the use of diaphragm valves may be restricted by the pressures, temperatures and corrosive environments typically encountered in LVOC plants.

The use of packed valves incorporating live loading spring assemblies mounted on the gland bolts compensates normal packing relaxation or the effects of thermal cycling and vibration. Valve Live Loading offers considerable improvements in long-term 'sealability' on rising stem gate valves, globe valves and regulating control valves. In the USA Valve Live Loading is

deemed as MACT (Maximum Achievable Control Technology) “equivalent to” a bellows valve. On frequently operated rising stem valves (most problematic) Live Loading offers a considerable improvement in long term emissions performance (< 500PPM for 3 - 5 years) [European Sealing Association, 2001 #152].

Valves that fail to perform as designed can have severe environmental implications – either for fugitive emissions or catastrophic failure. The risk of mechanical failure can be minimised by an appropriate regime of inspection and maintenance. However, valve failure is more frequently due to incorrect operation and this underlines the need for effective operating procedures.

2.3.12 Utility fluids

A variety of gases is used in installations to facilitate the operation of equipment or to carry out specific activities. Installations may have distribution systems for such gases as nitrogen, carbon dioxide and compressed air. These gases are usually inert and relatively benign in their own right, but may become contaminated with products or wastes in performing their duties and then require treatment.

Air, carbon dioxide and nitrogen have important uses for purging vessels and equipment of toxic or flammable atmospheres. Plant is typically purged with air prior to opening, and with nitrogen or carbon dioxide prior to start-up. Air purging of process vessels is not applicable to all processes where flammable vapours can be present and steam purging or nitrogen blowing is used instead. The desire, on environmental grounds, to minimise the quantity of purge gas has to be balanced against the overriding health and safety requirements. However, there may be scope to reduce purge volumes by questioning the need for vessel opening and by continuously analysing an indicator parameter (such as oxygen) to identify when purging is complete. The contamination of purges can also be reduced by ensuring that the plant is fully drained prior to the introduction of purge flows.

Compressed dry air is used for cleaning purposes, actuating control valves, actuating on/off valves and for operating instruments, but is less and less used for actuating the pneumatic controllers used in plant control. Installations also typically have a variety of reticulation systems for different qualities of water (e.g. drinking water, de-mineralised for boiler feed).

2.4 Management systems

Although management systems are a fundamental component of the ‘generic production process’ (and are shown as such in Figure 2.1), they are described in Section 5.1 because of their importance as a pollution prevention technique.

3 GENERIC APPLIED PROCESSES AND TECHNIQUES

Industrial organic chemistry uses the necessary unit processes, unit operations and infrastructure described in Chapter 2 to establish production processes for the desired products. Such is the variety of processes in the field of LVOC that detailed information exchange exercise has been restricted to a very small number of illustrative processes that are described in Chapters 7 to 13.

The vast majority of production processes have not benefited from such detailed information exchange and this limits the detail that can be provided in this BREF. In order to give an overview, there follow very brief ('thumbnail') descriptions of the most significant processes within each LVOC sub-sector.

Descriptions have been prepared where the process is commercially or environmentally significant, and where information was readily available. Most of the processes described have European production capacities in excess of the 100 kt/yr threshold that was proposed by several Member States, but the inclusion of a particular process description should not be seen as legal interpretation of the term LVOC.

The descriptions have been restricted to a brief outline of the process, any significant emissions, and particular techniques for pollution prevention and control. Since the descriptions aim to give an initial overview of the process, they do not necessarily describe all production routes. The descriptions are, therefore, a starting point in the determination of BAT and additional information may be needed.

If detailed process descriptions are required, then reference should be made to a standard text (e.g. [Ullmann, 1998 #80]) or to documents submitted to the information exchange (e.g. [InfoMil, 2000 #83] contains practical information on 55 LVOC processes in The Netherlands).

3.1 Chemical products with a process description

The process descriptions in this chapter are grouped according to the functional chemistry previously outlined in the BREF Scope. In addition, the following alphabetical index of product names indicates the page number of this chapter where a process description (for the named product) can be found.

ACETALDEHYDE, 41	GLYCOL ETHERS, 47
ACETIC ACID, 42	HEXA-METHYLENEDIAMINE, 55
ACETIC ANHYDRIDE, 48	HIGHER OLEFINS, 29
ACETONE, 41	ISOBUTENE, 30
ACETYLENE, 29	ISOPROPYL ALCOHOL, 38
ACRYLAMIDE, 53	MALEIC ANHYDRIDE, 48
ACRYLATE, 46	MELAMINE, 53
ACRYLIC ACID, 42	METHACRYLIC ACID, 45
ADIPIC ACID, 43	METHANOL, 38
ADIPONITRILE, 55	METHYL AMINES, 52
ALLYL CHLORIDE, 60	METHYL ETHYL KETONE, 42
ANILINE, 52	METHYL ISOBUTYL KETONE, 42
BISPHENOL ACETONE, 36	METHYL-TERTIARY BUTYL ETHER, 47
BUTENE, 29	NAPHTHALENE, 32
CAPROLACTAM, 56	OXO-ALCOHOLS, 38
CARBON DISULPHIDE, 63	PHENOL, 39
CARBOXYLIC ACID, 44	PHTHALIC ANHYDRIDE, 49
CHLORO FLUORO HYDROCARBONS, 60	PROPIONIC ACID, 45
CHLORO-ACETIC ACID, 45	PROPYLENE GLYCOL, 40
CUMENE, 31	PROPYLENE OXIDE, 47
CYCLOHEXANONE/OL, 41	PYRIDINE, 57
CYCLOHEXYLAMINE, 52	QUATERNARY AMMONIUM SALTS, 52
DIMETHYL TEREPHTHALATE, 46	STYRENE, 32
DIPHENYL METHANE DIISOCYANATE, 55	TEREPHTHALIC ACID, 45
DITHIOCARBAMATES, 63	TERTIARY BUTYL ALCOHOL, 41
EPICHLOROHYDRIN, 61	THIOLS, 63
ETHANOL, 37	THIOPHENE, 64
ETHANOLAMINES, 51	UREA, 53
ETHYL ACETATE, 46	VINYL ACETATE, 46
ETHYL PENTACHLOROTHIOPHENE, 63	
ETHYLAMINES & ISOPROPYLAMINES, 51	
ETHYLBENZENE, 31	
ETHYLENEDIAMINE, 52	
ETHYLHEXANOL, 35	
FORMIC ACID, 45	

3.2 Lower olefins

Europe's main olefin products are ranked on the basis of tonnage in Table 3.1. The Table also indicates what type of process description is provided in the BREF (if any). The most important olefin process is the production of ethylene (and associated butadiene and propylene) from the steam cracking of naphtha or ethane. This process is considered in detail in Chapter 7 as an illustrative process of the sub-sector.

Product	Production capacity (kt per year)	Process description?
Ethylene	18700	Illustrative Process
Propylene	12100	Illustrative Process ⁽¹⁾
1,3-Butadiene	2282	Illustrative Process ⁽¹⁾
n-Paraffin	833	
Acetylene	409	
Isobutene	374	✓
1-Butene	170	✓
Nonylene	150	

Note 1: Considered as a co-product of the cracking process.

Table 3.1: Lower Olefin products with European production capacities in excess of 100 kt/yr [UBA (Germany), 2000 #89] based on Standard Research Institute (SRI) data, Directory of Chemical Products Europe, Vol. II, 1996

Some of the other major olefin processes are:

ACETYLENE: The use of acetylene as a chemical intermediate has declined in favour of ethylene, propylene and butadiene. Its use now is mainly restricted to the production of butanediol and as a welding gas. Production is via two distinct routes, either based on calcium carbide (by dry hydrolysis, wet hydrolysis), or from hydrocarbons (by pyrolysis, natural gas oxidation, electric arc) [Austria UBA, 2000 #94] [Environment Agency (E&W), 1999 #7]. Environmental issues of the calcium carbide, and subsequent acetylene, production are:

Environmental issues
Air: Acetylene, ammonia, hydrogen sulphide and phosphine from purging of the generator feed hopper. Acetylene from the purification bed vent during regeneration. Ammonia and hydrogen sulphide from lime pits.
Water: Glycol from raw gas holding tank condensates (contributing to BOD and COD). Water condensate from the cooling of acetylene and combination with the gas holder glycol water seal. Calcium chloride from dryer blow-down. Ammonia and hydrogen sulphide from the ammonia scrubber used to purify raw acetylene.
Wastes: Carbon and ferro-silicates from the generator (the result of unreacted impurities in the carbide). Chromium and mercury from spent purifier bed solids. Lime hydrate can be re-used (e.g. in cement production, neutralisation).

BUTENE: is produced by the fractional distillation ('tailing topping') of mixed butylenes and butanes arising from crackers. It does not involve a chemical reaction. Residual distillation streams are used in other processes and there are no significant point emissions from the process [InfoMil, 2000 #83].

HIGHER OLEFINS: are linear olefins (alpha and internal) in the carbon range C₆ to C₂₀. The product from the higher olefin process depends on both the process technology and the feedstock (e.g. ethylene, propylene/butene). The process consists of two complementary techniques [Environment Agency (E&W), 1999 #7]:

- oligomerisation synthesis of alpha olefins from ethylene catalysed by a metal ligand catalyst dissolved in a solvent and
- isomerisation / disproportionation in which light C₄ olefins and C₂₀₊ olefins (plus unwanted C₆-C₁₈ olefins) are converted to mid-range C₆-C₁₄ internal olefins by molecular rearrangement.

ISOBUTENE (2-METHYLPROPENE): is a raw material for the production of butyl rubber. Tertiary butyl alcohol (TBA) is catalytically converted to isobutene and water. Crude product is purified by distillation [InfoMil, 2000 #83].

Environmental issues
Air: Carbon oxides, nitrogen oxides, PM10, VOCs.
Water: Bottom stream from distillation column is stripped and biologically treated.
Wastes: None specific to process.
Energy: Endothermic process.

LOWER OLEFIN WASTE WATER ISSUES. A recent survey of German olefin processes quantifies the volume of waste water arisings and the COD/AOX loads after any pre-treatment but prior to biological treatment (Table 3.2). The survey also records the pre-treatment techniques used to make waste waters amenable to biological treatment (Table 3.3).

Product	Waste water volume (m ³ /t product)				COD (kg/t product)				AOX (g/t product)				
	<0.1	0.1 - 1	1 - 10	>10	<0.1	0.1 - 1	1 - 10	>10	<0.1	0.1 - 1	1 - 10	10 - 100	>100
Ethylene/ Propylene/ Acetylene		X ⁽³⁾				X							
1,3-Butadiene		X			X								
Acetylene ⁽¹⁾			X					X					

(1) By thermal route
 (2) Figures include all emissions except rainwater and cooling water blowdown.
 (3) The CEFIC survey gave a broader range, probably as it included the cracking of heavy feedstock e.g. gas-oil.

Table 3.2: Quantification of waste water arisings from olefin processes
 [UBA (Germany), 2000 #88]

Product	Treatment technique						
	Incineration	Stripping	Distillation	Extraction	Sedimentation & Flocculation	Hydrolysis	Adsorption
Ethylene/ Propylene/ Acetylene		X					
1,3-Butadiene		X		X			
Acetylene ⁽¹⁾		X					

(1) By thermal route

Table 3.3: Treatment techniques for olefin process waste waters (excluding biological treatment)
 [UBA (Germany), 2000 #88]

3.3 Aromatics

Table 3.4 gives Europe's most important aromatic products (in tonnage terms) and also indicates what type of process description is provided in the BREF (if any). The production of benzene, toluene and xylene (BTX) is considered in detail in Chapter 8 as an illustrative process of this sub-sector. It also includes some detail of cyclohexane production because of its close links to the BTX process. The table is followed by brief descriptions of other aromatic processes that have major commercial importance as hydrocarbon intermediates.

Product	Production capacity (kt per year)	Process description?
Benzene	8056	Illustrative Process
Ethylbenzene	4881	√
Styrene	4155	√
Xylenes (mixed)	2872	Illustrative Process
Toluene	2635	Illustrative Process
Iso-propyl benzene (cumene)	2315	√
Xylene (para)	1342	Illustrative Process
Cyclohexane	1099	
Xylene (ortho)	727	Illustrative Process
Alkylbenzene	490	
Naphthalene	289	√

Table 3.4: Aromatic products with European production capacities in excess of 100 kt/yr [UBA (Germany), 2000 #89] based on Standard Research Institute (SRI) data, Directory of Chemical Products Europe, Vol. II, 1996

CUMENE: is produced from a reaction between propylene and benzene. The reaction is carried out under pressure at 250 °C and catalysed by phosphoric acid on kieselguhr. Zeolites can also be used as catalysts. Excess benzene is used to ensure complete conversion of the propylene. Products are separated by distillation, where propane (present in the propylene feedstock) is removed. Higher alkylated benzene by-products may be converted to cumene by trans-alkylation with additional benzene. Unreacted benzene is recycled to the reactor [Environment Agency (E&W), 1999 #7] [InfoMil, 2000 #83].

Environmental issues
Air: Storage tank blanket gases, purge and let-down gases are generally routed to flare, thereby releasing oxides of carbon.
Water: Phosphoric acid, hydrocarbons and amines from acid pot drainings and decommissioning washes.
Wastes: Spent catalyst and process residues.

ETHYLBENZENE: is a raw material for the production of styrene and propylene oxide. It is produced by the liquid or vapour-phase alkylation of benzene with ethylene over an aluminium chloride or zeolite catalyst. The current technology of choice for ethylbenzene is a liquid phase variant. The product is isolated by successive distillation stages to remove benzene (that is recycled to the feed) and di/tri-ethylbenzene (that is returned to the reactor). Impurities such as methane, hydrogen and ethane are separated from the reactor products and combusted (e.g. in a flare) fuel gas system. In the vapour-phase variant benzene and ethylene are pre-dried with molecular sieves, and these are regenerated using process gas at 220 °C. The zeolite catalyst is regenerated by burn-off using re-circulated nitrogen containing oxygen. A bleed of gas is vented to atmosphere to remove the resultant carbon dioxide. Special control techniques include double mechanical seals on pumps; the containment of benzene vapours from tanks/loading; stripping of organics from waste water and their combustion in a furnace [Environment Agency (E&W), 1999 #7] [InfoMil, 2000 #83].

Environmental issues
Air: Oxides of carbon and oxides of nitrogen from catalyst regeneration and ethylbenzene furnace; losses of benzene and other compounds from tank vents and loading operations; fugitive losses of ethylene, benzene and ethylbenzene from equipment and fittings; stack emissions of benzene.
Water: Benzene in the dehydration water and hydrocarbons in steam condensate. Treatment by wet air oxidation or VOC stripping (prior to biological treatment). Neutralisation effluents. Cooling water.
Wastes: Spent molecular sieve material. Tars and heavy fractions re-used as raw material or incinerated. Spent zeolite catalysts are regenerated (typically every 4 years) by off-site specialists.
Energy: The reaction is exothermic. Waste organic gases or liquids are recycled or used as fuel. Discontinuous gases at start-up and shutdown are combusted in a flare without energy recovery.

NAPHTHALENE: is a raw material for the production of phthalic anhydride and is widely used in pharmaceutical processes. The distillation of coal tar produces mostly naphthalene, but also a variety of other by-products (e.g. pyridine bases) [InfoMil, 2000 #83].

Environmental issues
Air: All waste gases are incinerated. Main pollutants are carbon and nitrogen oxides from the incineration.
Water: There are no process related waste water streams. Cleaning water is treated by biological methods.
Wastes: Solid waste is recycled or transported to a processor.
Energy: Endothermic process.

STYRENE: is mainly manufactured in a two-stage process comprising the catalytic alkylation of benzene with ethylene to produce ethylbenzene (EB), followed by the catalytic dehydrogenation of EB to produce styrene. The second commercial process consists of oxidation of EB to ethylbenzene hydro-peroxide, followed by reaction with propylene to give alpha phenyl ethanol and propylene oxide; the alcohol being then dehydrated to styrene. In the catalytic dehydrogenation route, purified EB is vaporised, mixed with superheated steam, and fed to the dehydrogenation reactor. The catalysts are generally formulated on an iron oxide base, sometimes including chromium and potassium. Reaction products are condensed and separated into water and crude styrene phases. Hydrogen-rich process gas is recovered and used as fuel in the steam super-heater and process water is normally purified in a stripper and recycled to the boiler. Crude liquid styrene, consisting primarily of styrene and EB with traces of toluene, benzene and tars, is transferred to storage. Crude styrene is purified using low-temperature vacuum distillation in conjunction with sulphur or nitrogen-based inhibitors to minimise polymerisation of vinyl-aromatic compounds. This process recovers benzene, EB and toluene. Toluene is normally sold, benzene returned to the EB alkylation reactor and EB recycled to the reactor feed. Tars are removed as distillation column residues. Purified styrene is mixed with inhibitor and transferred to storage tanks. In some facilities, an EB/benzene/toluene stream is separated from the crude styrene initially and processed separately [Environment Agency (E&W), 1999 #7] [InfoMil, 2000 #83].

Environmental issues
Air: Hydrogen from catalyst preparation; Benzene and EB from distillation processes; EB, benzene, toluene and styrene releases from the purification process and from storage tanks.
Water: Steam condensate containing EB, benzene, toluene and styrene is stripped prior to central biological treatment.
Wastes: Residue from distillation columns; Sulphur or nitrogen based residues from styrene purification; Spent catalyst.

AROMATICS WASTE WATER ISSUES. A recent survey of German aromatic processes quantifies the volume of waste water arisings and the COD/AOX loads after any pre-treatment but prior to biological treatment (Table 3.5). The survey also records the pre-treatment techniques used to make waste waters amenable to biological treatment (Table 3.6).

Product	Waste water volume (m ³ /t product)				COD (kg/t product)				AOX (g/t product)				
	<0.1	0.1 - 1	1 - 10	>10	<0.1	0.1 - 1	1 - 10	>10	<0.1	0.1 - 1	1 - 10	10 - 100	>100
Benzene/ Toluene	X				X								
Ethyl- benzene/ Cumene		X			X				X				
Styrene			X		X								

Note: Figures include all emissions except rainwater and cooling water blowdown.

Table 3.5: Quantification of waste water arisings from aromatic processes
[UBA (Germany), 2000 #88]

Product	Treatment technique						
	Incineration	Stripping	Distillation	Extraction	Sedimentation & Flocculation	Hydrolysis	Adsorption
Benzene/ Toluene		X		X			X
Ethyl- benzene/ Cumene		X					X
Styrene		X			X		X

Table 3.6: Non-biological treatment techniques for aromatic process waste waters
[UBA (Germany), 2000 #88]

3.4 Oxygenated compounds

The IPPC Directive (Section 4.1b of Annex 1) defines the sub-group of “*oxygen containing hydrocarbons such as alcohols, aldehydes, ketones, carboxylic acids, esters, acetates, ethers and peroxides*”. From this extensive list, illustrative processes have been chosen for the production of an ether (ethylene oxide – see Chapter 7), an alcohol (ethylene glycols– see Chapter 7) and an aldehyde (formaldehyde – see Chapter 10). Table 3.7 gives Europe’s most important oxygenated organic products (in tonnage terms) and also indicates what type of process description is provided in the BREF (if any).

Product	Production capacity (kt per year)	Process Description?
Formaldehyde	6866	Illustrative process
Methyl tertiary butyl ether (MTBE)	3159	✓
Methanol	2834	✓
Ethylene oxide	1887	Illustrative process
Phenol	1459	✓
Propylene oxide	1418	✓
Terephthalic acid	1310	✓
Acetic acid	1302	✓
Ethylene glycol	1210	Illustrative process
Acetone	1117	✓
Tertiary Butanol	1098	
Phthalic anhydride	1008	✓
Adipic acid	920	✓
Acrylic acid	860	✓
Dimethyl terephthalate (DMT)	855	✓
Acetaldehyde	844	✓
2-Ethylhexanol	838	✓
Isopropanol	811	✓
Ethanol	705	✓
Vinyl acetate	655	✓
Acrylate esters	645	
Bisphenol A	598	✓
n-Butanol	555	✓
Glycol ether	535	✓
Methyl methacrylate	522	
Acetic anhydride	504	✓
Sorbitol (hexahydric alcohol)	458	
Propylene glycol	447	✓
Citric acid	347	
n-Butyl acetate	338	
Formic acid	328	✓
Ethyl acetate	322	✓
Methyl ethyl ketone	300	✓
2-Butanol	285	
Iso-butyraldehyde	255	
Chloroacetic acid	235	✓
1,4-Butandiol	210	
Phthalic acid	180	
Maleic anhydride	176	✓
Pentaerythritol	159	
Benzoic acid	153	
Isobutanol	138	
Nonyl phenol	132	
Para-formaldehyde	117	
Propionic acid	112	✓
Methyl isobutylketone	109	✓

Note 1: The selection as an illustrative process was not a unanimous TWG decision.

Table 3.7: Oxygenated organics with European production capacities in excess of 100 kt/yr [UBA (Germany), 2000 #89] based on Standard Research Institute (SRI) data, Directory of Chemical Products Europe, Vol. II, 1996.

3.4.1 Alcohols

ETHYLHEXANOL: 2-Ethylhexanol is mainly used as the alcohol component in the manufacture of ester plasticisers (especially di-2-ethylhexyl phthalate – DOP) for soft polyvinylchloride. The second largest application is the production of 2-ethylhexyl acrylate which is used to manufacture coating materials (especially emulsion paints), adhesives, printing inks, impregnating agents and reactive diluent/cross-linking agents. In addition, 2-ethylhexyl nitrate is a cetane number improver and 2-ethylhexyl phosphates are used as lubricating oil additives. It is also used to make surfactants (antifoaming agents, dispersants, flotation agents) and as a solvent (for polymerisation catalysts and in extracting agents). The world-wide production capacity is some 3000 kt/yr. Some 1020 kt/yr is produced in the European Union at three plants in Germany (740 kt/yr) and one plant in each of France (125 kt/yr), Sweden (125 kt/yr) and Spain (30 kt/yr) [UBA (Germany), 2000 #92].

Butyraldehyde (butanal) is the main feedstock for 2-ethylhexanol process and is normally produced on the same installation. The manufacture of butyraldehyde is by the oxo synthesis route (hydroformylation of propylene and CO/H₂ synthesis gas). This is an exothermic gas/organic liquid phase reaction using a homogeneous cobalt catalyst at 130 - 150 °C and 100 - 300 bar. The high demands on the purity of 2-ethylhexanol product place similar purity demands on the butyraldehyde raw material. Isobutyraldehyde is formed to a greater extent (with cobalt catalysts) or a lesser extent (with rhodium catalysts) during hydroformylation and must be separated to prevent mixed aldolisation. The subsequent production of 2-ethylhexanol from butyraldehyde involves four main stages:

1. Aldolisation and dehydration: The aldol condensation of butyraldehyde raw material to 2-ethylhexenal proceeds rapidly in the presence of aqueous sodium hydroxide catalyst. The ensuing dehydration of the hydroxyaldehyde is conducted promptly because the aldol is unstable and can impair the product quality and yield. Local overheating in the reaction mixture must be avoided, since this may cause secondary reactions that decrease yields, and thorough mixing is required. The ratio of aldehyde to aqueous sodium hydroxide solution is in the range 1:10 to 1:20. The aqueous/organic liquid phase reaction may take place in a mixing pump, a packed column or a stirring vessel. The various processes operate at a temperature of 80 - 150 °C and pressures below 0.5 Mpa to give conversion rates of >98 %. The heat of the aldolisation reaction may be used for steam generation (e.g. 120 kg steam/t butyraldehyde) although this is only possible when the process is run close to 150°C (and this is not common).

2. Phase separation and purification: The reaction mixture is separated into an upper organic phase (the intermediate product 2-ethylhexenal) and a lower aqueous phase (containing the aldolisation solution). The 2-ethylhexenal is washed with process water to remove sodium hydroxide (giving a waste water stream) and then purified by distillation. The water content of the product is decreased by fractional condensation to decrease energy demand at the following vaporisation. Most of the aqueous aldolisation solution can be recycled but the rest must be removed from the system via a side stream because the aldolisation solution becomes diluted by water that is produced in the reaction. This bleed also removes the aldolisation by-products. The bleed has such a high COD value that pre-treatment is required when the efficiency of the biological treatment is low (COD removal <90 %). Suitable pre-treatment methods are oxidation, acid treatment/filtration, and extraction (which allow partial recycling of valuable products).

3. Hydrogenation: The unsaturated organic product (2-ethylhexenal) from the phase separator can either be hydrogenated in a single stage (e.g. fixed nickel or copper catalyst) or in several stages (a combination of gas-liquid phases, or liquid-liquid phases in sump-phase or trickle-bed reactor). The hydrogenation stage achieves a conversion of 100 % and a selectivity of >99 %. The heat of reaction for the hydrogenation of the C = C double bond and the aldehyde group is relatively high (178 kJ/Mol) and enables energy recovery through steam generation. The temperature must be controlled to prevent any local overheating that would decrease yields.

With single-step hydrogenation, re-mixing with the hydrogenation product has been proposed to dissipate heat (150–200 °C) and, in contrast to other processes, medium pressure is initially necessary to ensure adequate conversion. Modern plants normally utilise two stages to remove residual amounts of carbonyl compounds and to ensure that high-grade 2-ethylhexanol is obtained. An initial gas phase reaction is followed by a liquid phase reaction. Nickel, copper or mixed systems are preferred as heterogeneous hydrogenation catalysts. Optimisation of the catalyst increases efficiency by high selectivity, easier separation of side products (giving energy savings) and extending catalyst life (>2500 t product/ t catalyst) which reduces waste. Reaction takes place with a hydrogen excess and this is recycled. A higher purity of hydrogen (99.9 vol% instead of 97.5 %) may reduce waste gas volumes from about 1.3 m³/t to about 0.05 m³/t ethyl hexenal.

4. Distillation: Fractional distillation of the hydrogenation product normally takes place in three stages. In the first stage, the light ends are separated at the head and can be employed for the manufacture of 1-butanol. In the second stage, pure 2-ethylhexanol is collected at the head. In the third stage, the recyclable intermediate fractions are separated from the heavy oil (which may be used for heating purposes).

Process variants. The Aldox process is a process variant where the aldolisation and oxo reactions have been combined into a single step [Weissermel & Arpe, 1993 #59]. This is used by Shell in the USA and Exxon in the USA / Japan. By adding co-catalysts, such as compounds of Zn, Sn, Ti, Al, or Cu or KOH, to the original Oxo catalyst allows the three reaction steps (i.e. propene hydroformylation, aldol condensation and hydrogenation) to take place simultaneously. In addition to the KOH co-catalyst, Shell also uses a ligand modified hydroformylation catalyst in their Aldox process.

Environmental issues
Consumptions: The raw materials required to make one tonne of 2-ethylhexanol are: 1145 kg of 100 % butyraldehyde, 360 m ³ hydrogen and 1 kg nickel or copper catalyst. The yield is >=98 %.
Air: Waste air from hydrogenation and the storage of intermediate products can be incinerated or combusted in the site power plant. The waste gas stream from the storage of the final product (filling process) may be emitted to atmosphere without treatment. The estimated maximum loss is 4g total C per tonne of product.
Water: Waste water is mainly reaction water from the aqueous aldolisation step and process water from washing the intermediate product 2-ethylhexenal. The typical rate of effluent production is 0.15 - 0.2 m ³ /t of product. C ₄ compounds (mainly n-butyraldehyde and sodium butyrate) constitute roughly 50 % of the effluent organics and the remainder is C ₈ compounds (or C>8). These give an effluent with acute toxicity to fish (LID=32 - 45) and COD of <50 g/l (10 kg COD /t product). Waste water shows moderate biodegradability in municipal waste water treatment plants which can reduce the COD of process water by 60 % and the reaction water COD by >90 %. This is sufficient to eliminate toxicity to fish. To improve the elimination of COD the waste water may be pre-treated using neutralisation with sulphuric acid and phase separation (to give a 40 % COD reduction), and extraction with 2-ethylhexanol combined with distillation to recover the 2-ethylhexanol (giving 75 % COD reduction for the total pre-treatment). The organic load is reduced to 0.4 kg COD /t product after pre-treatment and biological treatment (total elimination 95 %). A similar performance can be obtained by minimising the waste water stream by optimising the washing step and treatment in an adapted waste water plant. Energy may be gained by incineration of the extract. In a Swedish plant, the waste water treatment involves decantation, stripping, biological treatment in biorotors, sedimentation and sand filtration; reducing the organic load by more than 99 % [SEPA, 2000 #76].
Wastes: Generally few or no wastes for disposal. Wastes from the last fractionation step, amount to <50 kg/t product and are combusted to recover their energy value. Copper and nickel from used hydrogenation catalyst amount to <0.4 kg/t product and are recovered

BISPENOL ACETONE (BPA): also known as Bisphenol A or 4,4-isopropylidenediphenol, is a raw material for the production of polycarbonate and epoxy resins. BPA is produced by the condensation reaction of phenol and acetone by two process variants: [InfoMil, 2000 #83]

BPA Route 1: The catalysed reaction of acetone and phenol takes place in a phenol-excess to maximise acetone consumption. The reaction product consists of BPA, BPA-isomers, BPA-oligomers, phenol, hydrogen chloride and water. The hydrogen chloride catalyst is recovered by distillation, and this also creates a waste water stream. Further distillation recovers phenol. BPA, BPA isomers and BPA oligomers are then removed with hot toluene solvent to leave a by-product of heavy tar. Cooling of the remaining liquid causes BPA to crystallise out and enables separation from the liquid in a centrifuge. Wet powder from the centrifuge is melted and vacuum-stripped of toluene. Toluene from the centrifuge and stripper is recovered as a light tar by-product (BPA-C). The melt is prilled to give a final product of BPA pellets.

Environmental issues
Air: HCl from the acid gas scrubbing system. Phenol from the phenol vent gas scrubber. Toluene from the toluene vent gas scrubber and prill tower. Toluene-containing gas from transport and storage of BPA-pellets. Flue gas emissions from the hot oil furnace.
Water: Water reaction product is separated by distillation, neutralised with caustic and treated centrally.
Wastes: No specific wastes as tar streams are re-used by customers.
Energy: The reaction is exothermic.

BPA Route 2: In this route, BPA is also produced by the catalytic reaction of acetone with excess phenol, but is crystallised and further processed without the hot toluene purification step. Acetone conversion is nearly 100 % and avoids the formation of by-products in the subsequent column. The reaction product consists of BPA, BPA-isomers, phenol and water. BPA is crystallised out of the mix by cooling, and is then separated by filtration. BPA from the filter is flash-stripped of residual phenol. The molten BPA is prilled to give final product. Liquid from the filter (consisting of phenol, BPA, BPA isomers and heavy ends) is sent to a recovery unit where BPA isomers are isomerised into BPA and recycled to the main crystallisation unit. A purge stream in this section removes the heavy ends (tars) for incineration.

Environmental issues
Air: Light ends arise from the phenol vent gas scrubber and are incinerated. When methyl mercaptan is used as a catalyst the off-gas is flared. Waste gas from the prill tower contains small amounts of solid BPA that require filtration. Phenol-containing gas from transport and storage of BPA-flakes.
Water: Water reaction product is washed in a special unit (distillation towers and strippers) to recover dissolved phenol and acetone, and is then treated biologically.
Wastes: Heavy ends burnt in an incinerator.
Energy: The reaction is exothermic.

ETHANOL: Most industrial ethanol is manufactured by the vapour-phase hydration of ethylene over a solid phosphoric acid catalyst supported on porous clay beads at around 240 °C and 68 barg. The reactor product is scrubbed with water to separate the ethanol. Unreacted ethylene is recycled. Ethanol is obtained from its aqueous solution by a series of distillations, followed by azeotropic distillation with benzene [Environment Agency (E&W), 1999 #7]. Alternative ethanol production routes are the indirect hydration of ethylene with H₂SO₄, and alcoholic fermentation [Austria UBA, 2000 #96].

Environmental issues
Air: Hydrocarbons from process vents.
Water: Caustic effluent from washing of the aqueous product prior to distillation and phosphates from the distillation process. The reactors are copper-lined and at each reactor catalyst regeneration there is a surge of copper in the aqueous effluent.
Wastes: Organic solvents, phosphoric acid and phosphates from spent catalyst

ISOPROPYL ALCOHOL (ISOPROPANOL): is produced by indirect or direct hydration. The indirect hydration of propylene / propane using sulphuric acid as a homogeneous catalyst produces isopropyl alcohol and four other solvents (di-isopropyl ether, dimethyl ketone, secondary butyl alcohol, and methyl ethyl ketone). Propylene and butylenes in mixed C₃ streams and mixed C₄ streams are reacted with 70 - 75 % sulphuric acid to form the corresponding alkyl sulphates, which are subsequently hydrolysed to the corresponding alcohols. The related ethers are formed as by-products. The crude alcohols are purified by distillation to give an isopropyl alcohol azeotrope with water and relatively pure secondary butyl alcohol. These may be sold or converted to the related ketones by dehydrogenation over a brass catalyst [Environment Agency (E&W), 1999 #7] [InfoMil, 2000 #83].

Environmental issues
Air: Oxides of carbon, oxides of nitrogen and oxides of sulphur from the incineration of waste process gases; Hydrocarbons from tank vents, strippers, condensers and reaction time tanks; Isopropyl alcohol from the cooling tower; Chromium from the incineration of solvent slops; Nickel from the incineration of caustic sludge.
Water: Alcohols, ketones, furfural, copper and zinc from aqueous interceptor discharges, spent sulphuric acid and caustic soda.
Wastes: Spent brass catalyst if not regenerated; Ash from incinerator.

The direct hydration of propylene uses a heterogeneous catalyst either in the vapour phase, the liquid phase or a vapour liquid mixture. The propylene feed is purified first by distillation to remove propane. Propylene is then hydrated in the vapour phase. The major by-product is di-isopropyl ether, but other by-products include n-propanol, acetone, hexanol and low-molecular weight polymer. The reaction takes place at approximately 180 °C and 34 barg over a catalyst of 42 - 46 % phosphoric acid on porous clay beads. The product is water-scrubbed to separate the isopropyl alcohol. Unreacted propylene is recycled, a purge being taken to prevent propane build-up. Isopropyl alcohol is purified by distillation, finally azeotropically using cyclohexane as an entrainer [Environment Agency (E&W), 1999 #7].

Environmental issues
Air: Hydrocarbons from tank and process vents; Fugitive releases of hydrocarbons.
Water: Propanols, organic phosphates and inorganic phosphates from water wash.
Wastes: Phosphoric acid and phosphates as spent catalyst.

METHANOL: is used as a solvent and as a feedstock for the production of formaldehyde, acetic acid, and MTBE. Methanol is formed by the catalytic conversion of synthesis gas (carbon monoxide, carbon dioxide and hydrogen). Synthesis gas is formed, with help of a catalyst, through catalytic cracking of natural gas (steam reforming) [InfoMil, 2000 #83]. High and low pressure versions of the process exist [Austria UBA, 2000 #96].

Environmental issues
Air: Waste gases are flared. Main emissions are carbon dioxide and nitrogen oxides. NO _x emissions can be reduced by cutting steam production.
Water: Biological treatment. Effluent contains inorganic chlorine compounds.
Wastes: Wastes are recycled or incinerated.
Energy: Self-supporting process (energy neutral).

OXO ALCOHOLS: The oxo alcohols range from C₄ butanols to C₂₀ alcohols, and they are produced by hydroformylation or carbonylation / hydrogenation [Environment Agency (E&W), 1999 #7]. For example, olefins and synthesis gas are catalytically reacted to form aldehydes that are then hydrogenated to oxo-alcohols. The by-products are a light oxo-alcohol fraction (used as fuel) and a high oxo-alcohol fraction (that is cracked to recover oxo alcohols) [InfoMil, 2000 #83].

In the manufacture of normal butyl alcohol by hydroformylation, synthesis gas and propylene are reacted over a catalyst at 170 °C and 70 barg. Unreacted propylene and synthesis gas are removed and the resultant mixture of catalyst in alcohol is distilled to separate the normal butyl alcohol from isobutyl alcohol.

The C₇-C₁₅ alcohols are produced by reacting the respective olefins and synthesis gas over a catalyst at 180 - 200 °C and 50 barg. After de-pressuring and recycling of evolved gas, the crude product is distilled under vacuum. The crude alcohol is treated with caustic soda to saponify by-product formates, water-washed and then distilled to remove unreacted olefins, by-product paraffin hydrocarbons and heavy fractions. The alcohols are hydrogenated at elevated temperature and pressure over a nickel catalyst to remove the traces of aldehydes.

Environmental issues
Air: Oxides of carbon, oxides of nitrogen and oxides of sulphur from the incineration of process waste gases and plant ejector vents. n-Butanol and mixed hydrocarbons from plant ejector vents and sludge incineration.
Water: Suspended solids, butanols, aldehydes and butyl formate from contaminated process aqueous effluent.
Wastes: Zinc oxide, cobalt, molybdenum, chromium oxide, iron oxide, copper oxide and activated carbon from the de-sulphurisation and converter catalysts and activated carbon absorbers.

In the carbonylation / hydrogenation route, the liquid olefins are reacted with carbon monoxide and hydrogen at 145 °C and 260 - 270 barg to give liquid aldehydes and by-products including heavy ends. The aldehydes are separated from the carbon monoxide and hydrogen, vaporised with hydrogen and then hydrogenated to give the corresponding alcohol. The alcohol is cooled, separated from the hydrogen and purified by distillation to remove unreacted olefins, methanol, water and heavy ends.

Environmental issues
Air: Oxides of carbon from the catalyst let-down vessels and reactor blow-down. Alcohols from hydro-refiner vents.
Water: Hydrocarbons in ejector condensate. Methanol in wash waters.
Wastes: Spent catalyst.

PHENOL [Finnish Environment Institute, 1999 #72]: Phenol is mainly used in the manufacture of bisphenol-A (38 % of production), phenolic resins (27 %), caprolactam (24 %) and alkyl phenols (4 %). The world-wide production capacity is about 6400 kt/yr. The European production capacity is some 2300 kt/yr with the bulk of production in Germany (740 kt/yr), Belgium (440 kt/yr), Italy (400 kt/yr), Spain (320 kt/yr), France (150 kt/yr), Finland (130 kt/yr) and Holland (120 kt/yr). There are a number of phenol production routes that are defunct or have very limited commercial application (e.g. extraction from coal tar, sulphonation using sulphuric acid, dehydrogenation of cyclohexanone / cyclohexanol). Today, the main route is the cumene process (about 90 % of world production), with lesser production by the Tolox and monochlorobenzene processes.

In the two-stage **cumene process**, cumene is first formed by the alkylation of benzene and propylene over a fixed-bed of zeolites (or, in older plants, aluminium trichloride or phosphoric acid catalysts). Polyisopropylbenzene is formed as a by-product and, by a transalkylation reaction, is further reacted with benzene to form more cumene. Cumene is separated from the reaction mixture and purified by distillation. In the second stage, purified cumene is first air oxidised to cumene hydroperoxide in a multistage liquid phase reactor. A distillation step then increases up to 65 - 90 % the concentration of cumene hydroperoxide, which is then decomposed with an acid catalyst (normally sulphuric acid) in a cleavage reactor to produce phenol, acetone and also valuable co-products like acetophenone and alpha-methylstyrene. Phenol and acetone are then purified by distillation. The alpha-methylstyrene may be hydrogenated to cumene (with nickel slurry catalyst, or preferably over a fixed bed palladium catalyst) and recycled. Some of the heavy by-products are thermally cracked to lighter

components and recycled to the fractionation section. The heavies are used as a sulphur-free fuel to produce energy in a boiler or power plant. The yield of cumene in the first stage is 98.7 - 99.6 %, and the phenol yield in the second stage is about 93.0 %. The cumene route using zeolite catalyst is regarded as BAT for phenol production. If the by-product alpha-methylstyrene is hydrogenated the Pd-catalyst is preferred to the Ni-catalyst.

Environmental issues
Air: Typical emissions from a modern plant are (as kg/t of products): propylene (0.4), propane (0.2), benzene 0.2), acetone (0.9), cumene (0.4), NO _x (0.3), SO ₂ (0.01) and CO ₂ (520).
Water: Phenolic compounds in waste water are recovered for recycle to the process. Waste water is typically generated at a rate of 0.5 t / t of products and contains phenol (0.1 kg / t of products), methanol (0.4 kg / t of products) and DOC (2.4 kg / t of products). Biological treatment normally ensures that about 99.9 % of the phenol is removed.
Wastes: Phenolic scrap, towels & contaminated clothing, laboratory samples, vessel sediments (during shut-down) and ion-exchanger resins typically account for 0.4 kg / t of products and require special treatment. General wastes (from housekeeping, insulation, construction, cleaning) account for 0.2 kg / t of products and are combusted or landfilled.

The **toluene (Tolox) process** is less efficient and less common, but it gives no acetone by-product. Toluene is oxidised with air to benzoic acid (and benzaldehyde and benzyl alcohol co-products) which is then further oxidised to phenol and sodium benzoate [InfoMil, 2000 #83]. Benzoic acid and its sodium salt can also be sold as products. Europe's one plant (Botlek, Holland) makes about 120 kt/yr by this route.

In the **monochlorobenzene** process, benzene is oxychlorinated with air and hydrochloric acid, or air and chlorine, to form monochlorobenzene. The monochlorobenzene is then hydrolysed to phenol with a caustic solution in tubular reactors at 400 °C, or with steam in the gas phase at 450 °C in the presence of catalyst.

For all process routes, the chemical and physical properties of raw materials and products necessitate high priority for operating procedures, maintenance and to technical standards and specifications (e.g. materials of construction, types of single pieces of equipment and safety systems) to ensure environmental protection and the health of personnel.

Emerging Techniques for the production of phenol include:

- *Vacuum pyrolysis of wood waste:* Dry and shredded bark of softwood is pyrolysed in a vacuum converter at 500 °C. The product contains about 30 % oil with high concentration of phenols and can be used in the manufacture of certain types of phenol-formaldehyde resins. Methods to further rectify the oil fraction for use in fine chemicals are being developed. A pilot plant converting 3.5 t/h dried bark has been constructed in Canada.
- *Reactive distillation in cumene production:* Benzene and propylene are reacted in a distillation column in the presence of a zeolite catalyst. Catalytic distillation allows the reaction to take place at low temperature, because the reaction product is continuously removed from the reaction zone by distillation. The purity of the cumene product is very high and the product yield is higher than in the conventional process. A plant in Formosa planned to start up in 1999, but the project has been delayed.
- *Direct oxidation of benzene:* In a totally new approach the benzene is directly oxidised to phenol using nitrous oxide in a single stage process. Besides being a low-cost route to phenol, the process has several environmental benefits; there is no production of cumene or acetone by-product, there is no aqueous waste, and no NO_x emissions. The nitrous oxide can under certain circumstances be recycled. The process was originally developed at the Boreskov Institute of Catalysis in the former Soviet Union early 1880's. The rights to this process were acquired by an American company, which continued the development work together with Russian scientists in the 1990's. A plant based on this process is under construction in Pensacola, Fla. (USA).

PROPYLENE GLYCOL: is used as a solvent and in organic synthesis. Propylene glycol is produced by the hydration of propylene oxide (PO) with water to form mono-, and di-propylene glycol (MPG and DPG). Before the reaction the PO is purified (washed) with caustic soda. The by-products are tri-propylene glycol and higher compounds. Through distillation the different products are separated (MPG and DPG are side streams of the column). Top and bottom stream of the distillation column are externally reprocessed to products [InfoMil, 2000 #83].

Environmental issues
Air: Main emission is carbon dioxide.
Water: Caustic soda solution directed to the waste water treatment plant or externally incinerated.
Wastes: Acids and bases treated biological waste water treatment plant.
Energy: Exothermic process with energy recovery.

TERTIARY BUTYL ALCOHOL: TBA is a raw material for the production of MTBE. TBA can be produced by the direct hydration of isobutene ($C_4H_8 + H_2O$); the indirect hydration of isobutene ($C_4H_8 + H_2SO_4$); or as a by-product during the production of propylene oxide (Oxirane process) ($C_3H_6 + C_4H_{10} + O_2$) [Austria UBA, 2000 #96]. TBA is also formed by the air oxidation of isobutane, with the tertiary butyl hydroperoxide (TBHP) by-product being further reacted with propylene to produce TBA and propylene oxide [InfoMil, 2000 #83].

Environmental issues
Water: No significant emissions identified. Waste water is biologically treated.
Energy: Endothermic process

3.4.2 Aldehydes

In addition to the description of the formaldehyde process in Chapter 10, there is:

ACETALDEHYDE: is produced by the oxidation of ethylene or C_3/C_4 alkanes, or oxidative dehydrogenation of ethanol [Austria UBA, 2000 #96]. Oxidation of ethylene is performed in aqueous solution with homogeneous catalysis with Cu or Pd chlorides. The one-step process leads to chlorinated by-products (chloroacetaldehyde) which are easily degraded/hydrolysed by biological treatment. The two-step process leads to considerable concentrations of non-degradable chlorinated substances, which can be effectively pre-treated by hydrolysis.

3.4.3 Ketones

ACETONE: can be produced by the oxidation of propylene ($C_3H_6 + \frac{1}{2} O_2$); the dehydrogenation or oxidation of isopropanol (C_3H_7OH); or by co-production in the Cumol process for phenol production (iso-propylbenzene + O_2) [Austria UBA, 2000 #96].

CYCLOHEXANONE/OL: is produced catalytically by the oxidation of cyclohexane. By-products are adipic, glutaric and succinic acid (C_1-C_5 acids). The intermediate reaction product (cyclohexylester) is decomposed with water. The aqueous phase from this hydrolysis contains water-soluble organic acids and the catalyst ('acid waste water stream'). The organic phase is washed with NaOH to decompose esters and peroxides, giving an 'alkali waste water'. The reaction mixture is further purified by distillation. In new installations cyclohexanone/ol is produced by the hydrogenation of phenol.

Environmental issues
Water: Catalyst recycled from acid waste water stream by crystallisation and can be improved by pre-treatment with wet oxidation or extraction (to reduce high organic load). Another option is recovery of by-product organic acids and incineration of the remaining aqueous residue. The alkali waste water is treated (option: recovery of organic acids) giving a residue which is incinerated. The remaining waste water is treated biologically with high efficiency (>90 % COD-elimination).

METHYL ETHYL KETONE (MEK) is produced by the catalytic dehydrogenation of 2-butanol (C_4H_9OH) [Austria UBA, 2000 #96].

METHYL ISOBUTYL KETONE: or hexone, is produced by the self-condensation of acetone followed by hydrogenation on a palladium catalyst in the presence of an ion exchange resin.

3.4.4 Carboxylic acids

ACETIC ACID: can be produced by three routes:

A. Acetaldehyde oxidation occurs catalytically in air in the presence of manganese acetate at 50 - 80 °C and 10 barg. The oxidation reaction product is distilled to remove gases including unreacted acetaldehyde, methyl acetate, acetone, carbon monoxide, carbon dioxide and nitrogen. Crude glacial acetic acid is obtained, with impurities of formaldehyde and formic acid. Final purification of the acid involves distillation in the presence of potassium permanganate, sodium dichlorate or other oxidants.

B. The liquid-phase catalytic oxidation of light hydrocarbons occurs in air at 150 - 200 °C and 40 - 50 barg. The aqueous reaction product is purified in a series of distillation columns producing acetic, formic and propionic acids and acetone. Lean off-gas from the reactor is dried and recovered in activated carbon beds. The remaining gas is combusted.

Environmental issues
Air: Light hydrocarbon off-gas from the activated carbon beds/thermal destruction system. Acetic acid, acetaldehyde, acetone, carbon monoxide and other organics from vacuum pump discharges. Scrubbed vent gases from the acetone recovery unit containing acetone, methyl acetate, benzene, acetic acid, methyl ethyl ketone, esters, methanol and some high-boiling-point components. Special control techniques may include thermal oxidation of the reactor off-gas, including recovery of heat and power by use of off-gas expanders and waste heat recovery.
Water: Acetic acid, ketones, methanol, and acetaldehyde from vacuum systems. Final residues of butyric and succinic acids; aqueous streams from the distillation unit. Water from acetone recovery unit containing methanol, ethanol, & traces of acetone and sodium salts. Discharge from hydro-extractive distillation of propionic acid contains propionic acid, acetylacetone & 2,4-hexadiene.
Wastes: Waste from dryers, activated carbon beds and catalyst systems. Corrosion products containing a glass lead mixture contaminated with nickel oxalate and oxides of chromium and iron.

C. Methanol carbonylation can use vessels constructed in Hastelloy C and pressures of 700 barg with copper/cobalt catalyst systems in the presence of iodine. The alternative is to use rhodium/phosphine complexes as the catalyst system and hydrogen/methyl iodide as promoter at pressures of 33 - 36 barg and temperatures of 150 - 200 °C. Purification involves multiple distillation to remove the catalyst mixture, water, mixed acids and other impurities.

Environmental issues
Air: High-pressure off-gas from the reactor, which is absorbed and scrubbed in a light ends recovery system before venting to a thermal destruction unit and contains small quantities of hydrogen iodide. Flared light ends from the first two distillation columns that pass via a low-pressure absorber system containing chilled acetic acid before being vented to a thermal destruction unit, again containing small quantities of hydrogen iodide. Special control techniques may include off-gas scrubbers, using methanol or acid that is recycled back to the process.
Water: Liquor from iodine scrubber during catalyst addition. Liquor from the final column light ends scrubbers contaminated with acetic acid.
Wastes: Heavy fractions from the heavy acids column (comprising propionic and acetic acids together with potassium salts and catalyst).

ACRYLIC ACID is produced by the catalytic oxidation of propylene via the intermediate acrolein ($C_3H_6 + O_2$) [Austria UBA, 2000 #96]. Product is generally separated from an aqueous solution (20 - 25 %) by extraction. Emissions are minimised by incinerating both waste water and waste gas.

ADIPIC ACID: The commercial manufacture of adipic acid is achieved in two stages. In the first stage the oxidation of cyclohexane, or the hydrogenation of phenol, gives a cyclohexanone/cyclohexanol mixture (known as ketone alcohol). In the second stage, ketone alcohol is catalytically (copper, vanadium salts) oxidised with nitric acid. By-products are glutaric and bernstein acid, nitrous oxides, especially N_2O . NO_x is stripped with air, giving a waste gas stream. Water is removed from the reaction mixture by distillation giving a waste water stream. Adipic acid is isolated and purified by two-stage crystallisation/centrifugation and washing with water.

In the past, several manufacturers used air oxidation (rather than nitric acid oxidation) of KA to produce adipic acid. However this process produced low quality adipic acid and is not a commercial option. Research into a butadiene carbonylation process (which does not produce N_2O emissions) was abandoned due to excessive cost.

Environmental issues

Air: The process releases substantial quantities of nitrous oxide (N_2O) from the stripping columns and crystallisers (estimated at 300g N_2O per kilogram of adipic acid produced - Thiemens and Trogler, 1991). This N_2O rich off-gas can be **re-used** in two ways:

- by burning at high temperatures in the presence of steam to manufacture nitric acid (this utilises the N_2O off-gas and also avoids the N_2O generated in nitric acid production); or
- by using N_2O to selectively oxidise benzene to phenol. A US company suggests that replacing its existing thermal off-gas treatment with this alternative can reduce production costs by 20 %.

If N_2O is not re-used, the two most widely used **end-of-pipe techniques** are catalytic decomposition and thermal destruction:

- a) *Catalytic decomposition* uses metal oxide catalysts (e.g. MgO) to decompose the N_2O into N_2 and O_2 . Heat from the strongly exothermic reaction may be used to produce steam. Catalyst typically needs to be replaced twice a year. A simpler, once though version of the technique is being piloted in the USA.
- b) *Thermal destruction* involves combustion of the off-gases in the presence of methane. The N_2O acts as an oxygen source and is reduced to nitrogen, giving emissions of NO and some residual N_2O . The combustion process can be used to raise steam. The heat of N_2O decomposition, combined with fuel energy, helps provide low-cost steam.

Table 3.8 gives an overview of the techniques implemented in Europe and their efficiency. Reducing furnace technology was developed by Bayer and started operation in 1994. The other German manufacturer, BASF, installed a catalytic system at their Ludwigshafen plant in 1997. In June 1998, the French company Alsachimie, a subsidiary of Rhodia, brought on stream a system to convert N_2O to nitric acid at their Chalampe site.

The costs of catalytic decomposition and thermal destruction are broadly similar. Re-using N_2O to manufacture nitric acid can be a cost-effective option in some circumstances. Table 3.9 gives an indicative calculation of abatement costs based on the reported capital costs for a German plant

Other emissions: Adipic acid particulates from drying and handling. Other organics from feedstock, absorbers and purification columns on the KA section. Caproic, adipic, valeric, butyric, propionic and acetic acids (all of which have pungent odours) from acid handling and storage.

Water:

Cyclohexanone/ol stage: Catalyst and organics from ketone alcohol purification. Oily water. Low pH waste streams containing adipic, boric, glutaric and succinic acids with copper, vanadium and sulphuric acid. Special control techniques are ion exchange systems to remove inorganic salts, such as copper or vanadium salts from catalysts; evaporation and crystallisation to recover boric acid and other by-products. The remaining organic waste water components are biologically treated. Organic loads can be reduced by optimised phase-separation and extraction with incineration of the organic phase.

Adipic acid stage: The mother liquor from the first centrifugation (of crude adipic acid) is partly recycled to the oxidation reactor and a bleed is treated to recover HNO₃, catalyst and organic acids. Mother liquor and washing water from the second centrifugation are re-used in the first centrifugation stage. The waste water stream from distillation is treated biologically with high efficiency (> 90 % COD-elimination). By consequently separating uncontaminated cooling water streams, recycling of aqueous waste streams, recovery of HNO₃ and changing from discontinuous to continuous operation in an existing plant the waste water flow could be reduced by 98 % and the COD-load by 86 % (Bayer). Emission after biological treatment is < 3 kg TOC/ t product.

Wastes: Ketone alcohol catalyst from plant cleaning. Non-volatile organic residues and organic recovery tails from ketone alcohol production. Wastes on shutdown, i.e. tar-contaminated sand, oxidiser residues, ketone alcohol sump dreggings. Boric acid sweepings. Caustic wash residues.

Country	Manufacturer	Technique	Efficiency by 2000	Implementation date
UK	Du Pont	Thermal	94 %	1998
France	Rhodia	Conversion to HNO ₃	98 %	1998
Germany	Bayer	Thermal	96 %	1994
Germany	BASF	Catalytic	95 %	1997

Table 3.8: Implementation of N₂O abatement options at European adipic acid plants
[Ecofys / AEA Technology, 2001 #150]

Capital cost (million €)	12.8		
Annual costs (million €)	1.3		
Emissions abated per year (tonnes)	55100		
Cost effectiveness at discount rate of	4 %	2 %	6 %
Cost-effectiveness (€/t N ₂ O abated)	44	42	48
Cost-effectiveness (€/t CO ₂ eq abated)	0.1	0.1	0.2
Based on following assumptions:			
a) The non-recurring capital cost is 12.8 million € ₁₉₉₀ (27 million DM in 1995 prices).			
b) Annual recurring costs are assumed to be 10 % of the investment cost.			
c) The option has a lifetime of 15 years.			
d) The plant treats 58000 tonnes of N ₂ O per year and is effective in removing 95 % of emissions.			

Table 3.9: Summary of the cost of N₂O abatement from adipic acid plants
[Ecofys / AEA Technology, 2001 #150]

CARBOXYLIC ACID: Glyoxylic acid is used for the production of vanillin, ethyl vanillin, allantoin, ion exchanger resins and as raw material in the pharmaceutical industry. A few different processes for the production of glyoxylic acid exist [Austria UBA, 2000 #131]:

- **Oxidation of glyoxal:** A solution of glyoxal in water is oxidised with nitric acid or with nitrogen oxides. In the first separation step oxalic acid is crystallised at temperatures of approximately 20 °C. With further cooling to temperatures between -10 °C and 0 °C glyoxylic acid crystallises.

- **Oxidation of acetaldehyde:** During the oxidation of acetaldehyde for glyoxal production 10 % glyoxylic acid are produced. An increase in temperature and higher concentrations of nitric acid will provide higher amounts of glyoxylic acid.
- **Oxidation of ethylene:** Ethylene is oxidised with nitric acid to glyoxylic acid in the presence of palladium salt.
- **Ozonolysis of maleic anhydride:** Raw material for the production of glyoxylic acid with ozonolysis is maleic anhydride. The process uses temperatures between -15 and -25 °C. By-products are formic acid and carbonic acid. The advantage is that nitric acid is replaced by ozone for the oxidation and thus less emissions can be expected. The disadvantage of this process is the high amount of electric energy, which is necessary for the production of ozone. This process route has emissions of:
 - *Air emissions:* Exhaust gas of the ozonolysis plants is incinerated
 - *Wastes:* Liquid by-products, contaminated solvents, and distillation residues from the ozonolysis plants may be incinerated

CHLORO-ACETIC ACID: The chlorination of acetic acid produces (mono) chloro-acetic acid. The HCl by-product is cooled, condensed and recycled to the reactor, and any residual acidity is removed in a scrubber. The di-chloro-acetic acid and hydrogen by-products are converted to mono-chloroacetic acid, HCl gas and some unwanted aldehydes (removed in alkaline scrubber). Excess hydrogen is vented to atmosphere [InfoMil, 2000 #83]. Waste water contains high loads of chloro-organics (see Table 3.10) but is amenable to biological treatment.

FORMIC ACID: can be produced as a by-product of acetic acid manufacture (a liquid-phase catalytic oxidation), or from routes based on methyl formate, methyl formate via formamide, or sodium formate [Environment Agency (E&W), 1999 #7].

METHACRYLIC ACID: is manufactured by the acetone cyanohydrin process, or the vapour-phase catalytic oxidation of isobutylene or tertiary butanol [Environment Agency (E&W), 1999 #7]. The acetone cyanohydrin process comprises five process stages, starting with the conversion of the cyanohydrin to an amide in a stirred reaction vessel. The amide is then hydrolysed to methacrylic acid. The methacrylic acid is recovered in a phase separator and purified by distillation. Organic material is recovered for recycle and spent acid can be recovered.

Environmental issues
Air: Vent gases from the by-product acid separator. Vent gases from the reactor and hydrolyser containing carbon monoxide, sulphur dioxide, and organic compounds, including methacrylic acid. Control techniques include destruction of the fuel-rich vent in a gas burner.
Water: Waste streams from vacuum systems containing organics. Waste water from the organics recovery unit. Special control techniques include the recovery of organics from purge water.

PROPIONIC ACID: is either manufactured as a by-product of acetic acid manufacture, or by the OXO process [Environment Agency (E&W), 1999 #7].

TEREPHTHALIC ACID: is manufactured by first oxidising para-xylene in an acetic acid carrier liquid to produce a crude terephthalic acid, and then selective catalytic hydrogenation of the crude product to allow a recovery of pure terephthalic acid. Both the oxidation and the purification steps employ crystallisation of the reaction products, followed by solid/liquid separation (using a centrifuge or filter) and solids drying to recover pure terephthalic acid from the process solvents / by-products. Special control techniques include: the recovery of by-product organic acid and catalyst traces as a solid residue; the optimisation of the reactor conditions to minimise by-product production; lagoons to cope with high peak BOD loads (from

equipment washing, or process blockages), and incineration of off-gases [Environment Agency (E&W), 1999 #7] [InfoMil, 2000 #83].

Environmental issues
Air: Off-gases from the oxidation stage containing carbon monoxide, acetic acid, methyl acetate, para-xylene and methyl bromide. Solvent recovery column vent (containing carbon monoxide, methyl acetate, para-xylene and acetic acid). Atmospheric absorber vent (containing acetic acid and methyl acetate). Purification plant scrubber containing terephthalic and acetic acids. Off-gas dryer vents (containing methyl acetate, acetic acid and para-xylene).
Water: Aqueous condensate from solvent recovery and acetic acid dehydration columns containing acetic acid, formaldehyde, methyl acetate, para-xylene and methanol. Waste water from purification of the crude terephthalic acid contains para-toluic acid, terephthalic acid, benzoic acid and other organic acids, together with manganese and cobalt salts. Aqueous condensate from the residue treatment crystalliser steam eductors. Recovery of by-product. Biological treatment because of high BOD-loads.
Wastes: Filter cake from residue recovery area.

3.4.5 Esters

ACRYLATE is produced by the esterification of acrylic acid with different alcohols (e.g. CH₃OH or C₂H₅OH) [Austria UBA, 2000 #96]. The highly odorous emissions are minimised by incinerating both waste water and waste gas.

DIMETHYL TEREPHTHALATE (DMT) is used to produce polyester resins for fibres and photographic film. DMT is produced by the oxidation of p-xylene and methanol with concurrent esterification. In the first oxidation step, p-xylene is catalytically oxidised with air to p-toluylic acid (PTS) and water. In the first esterification step converts PTS and methanol to PTE (para-toluylic methylester) and water. PTE is then oxidised to HE (mono methylterephthalate) and water. In the second esterification step DMT and water are formed from HE and methanol. Raw DMT is purified by distillation. Methanol used in the DMT production can be recycled from the polymerisation step (PET production). The waste water stream may be incinerated but also treated in a waste water treatment plant. Even if the reaction is exothermic, there is a need for a large amount of energy to keep the process at the right temperature (above melting point of products). DMT can also be produced by the esterification of terephthalic acid and methanol [InfoMil, 2000 #83] [Austria UBA, 2000 #96].

Environmental issues
Air: The high concentrations of organic dust in the oxidation reactor off-gas are reduced by cooling (with heat recovery); washing (to remove polar compounds); and activated carbon filtration. Organic residues are incinerated and off-gases are filtered (to remove cobalt and manganese). The vent gases are washed in a scrubber and the residual gas is incinerated.
Water: Waste water stream is incinerated.
Wastes: Hazardous wastes are incinerated.
Energy: Exothermic process with energy recovery.

ETHYL ACETATE is produced by the esterification of acetic acid and methanol (CH₃COOH + C₂H₅OH), or from acetaldehyde using a Tischtschenko reaction [Austria UBA, 2000 #96].

3.4.6 Acetates

VINYL ACETATE can be produced by the oxidation of ethylene (C₂H₄ + ½ O₂ + CH₃COOH) or catalytic addition of acetylene to acetic acid (C₂H₂ + CH₃COOH). Ethylene, acetic acid and oxygen undergo a vapour phase reaction at 160 °C and 8 barg over a noble metal catalyst of palladium and gold and potassium acetate supported on silica beads. The product is quenched, carbon dioxide is removed using hot potassium carbonate, and unconverted oxygen and

ethylene recycled. Acetaldehyde, ethyl acetate and higher esters are formed as by-products. A purge stream prevents inert build-up. Unconverted acetic acid is separated from the crude product by distillation and recycled. The vinyl acetate is purified in a series of distillation columns [Environment Agency (E&W), 1999 #7]. Vinyl acetate can be also produced from acetylene and acetic acid.

Environmental issues
Air: Hydrocarbons from the reactor loop purge. Carbon dioxide from absorption/desorption system.
Water: Sodium acetate in the neutralised aqueous effluent from water stripping.
Wastes: High boilers, light ends etc are used as fuel.

3.4.7 Ethers

GLYCOL ETHERS: mono, di, and higher glycol ethers are produced catalytically from an alkene oxide (ethylene or propylene oxide) and an alcohol (methanol or n-butanol). The products are purified through distillation and residual streams (containing catalyst) are incinerated [InfoMil, 2000 #83].

Environmental issues
Air: VOC, ethylene oxide and propylene oxide (mainly from fugitive sources).
Water: Biological treatment.
Wastes: None significant.
Energy: Exothermic process

METHYL-TERTIARY BUTYL ETHER: MTBE is an important additive for petrol and more information can be found in the Refineries BREF. Minor production occurs from the dehydrogenation of isobutane and the oxidation of isobutane [Austria UBA, 2000 #134]. However, the majority of MTBE is produced by the addition of methanol to isobutene, in the presence of an acid catalyst ($\text{CH}_3\text{OH} + \text{C}_4\text{H}_8$). The crude product is purified by distillation. A refinery mixture (containing different butanes, butenes and isobutene) is used as feedstock and, after the isobutene has been reacted, the other compounds are returned to the refinery. Methanol is recovered. The by-products of tertiary butyl alcohol, dimethyl ether and di-isobutene can be used as fuel [InfoMil, 2000 #83] [Austria UBA, 2000 #134].

Environmental issues
Air: End-of-pipe technology: flare with gas recovery system. VOC losses predominantly from fugitive sources.
Water: Waste water is treated physically (sand / oil removal by filtration and gravity separation) and biologically.
Wastes: Significant process waste not identified. Used catalyst treated externally. Remaining liquids are recycled or also treated externally.
Energy: Exothermic process.

3.4.8 Epoxides

Ethylene oxide considered in detail as an illustrative process in Chapter 9.

PROPYLENE OXIDE: can be produced by the indirect oxidation of propylene with hydro peroxides or peroxy carbon acids (Oxirane process $-(\text{C}_3\text{H}_6 + \text{C}_4\text{H}_{10} + \text{O}_2)$) or chlorohydrin process $(2\text{C}_3\text{H}_6 + 2\text{HOCl} + \text{Ca}(\text{OH})_2)$ [Austria UBA, 2000 #96]. The Oxirane process starts with oxidation of isobutane with pure oxygen to get a mixture of Tertiary Butyl Hydro Peroxide (TBHP) and Tertiary Butyl Alcohol (TBA). Isobutane is recovered from the TBA/TBHP solution by distillation and is then mixed with catalyst and propylene and reacted in the epoxidiser section to form propylene oxide. Further distillation recovers the unreacted propylene

and catalyst to produce pure propylene oxide and TBA products. Recovered catalyst is conditioned for re-use with a centrifuge and a film evaporator, and this also gives a vapour product which is used as a fuel gas, and a solid fuel product [InfoMil, 2000 #83]. The current production trend is to substitute isobutane with ethylbenzene leading to the production of styrene together with propylene oxide.

Environmental issues
Air: Isobutane from oxidation unit and first distillation column analysers. Fugitive emissions due to high pressures and temperatures of reactor and distillation. All other emissions used as fuel gas in vapour recovery system (e.g. flare).
Water: Caustic washing in the isobutane distillation creates a stream of mixed hydrocarbons that requires stripping prior to biological treatment.
Wastes: Solid fuel from the catalyst recovery unit is used in power stations and cement factories.
Energy: The reactions are exothermic and steam is generated at several stages. Excess fuel gas can be exported for its calorific value.

3.4.9 Anhydrides

ACETIC ANHYDRIDE: The main production are the acetic acid/ketene route and carbonylation of methyl acetate [Environment Agency (E&W), 1999 #7].

- in the acetic acid/ketene route, acetic acid is catalytically decomposed (cracked) to give ketene and water at 700 °C and reduced pressure. Alternatively, positive pressure may be used. Product vapours from the process comprise ketene, some unreacted acetic acid and by-products. The ketene is added to acetic acid under reduced pressure to give acetic anhydride that is recovered by distillation
- in the carbonylation route, methanol is first esterified with acetic acid (possibly from a recycle source) or a portion of the product acetic anhydride, to produce methyl acetate. Carbonylation of methyl acetate yields acetic anhydride. This route is associated with the carbonylation of methanol to acetic acid.

MALEIC ANHYDRIDE: Maleic anhydride is used for the production of unsaturated polyesters, the production of fumaric and maleic acid, as intermediate for the production of pesticides, fungicides, insecticides and herbicides and as additive for lubricating oil. In 1991 36 % of maleic acid production capacity was still based on benzene oxidation and the rest was from the oxidation of C₄ compounds especially butane and butene. A small amount of maleic anhydride by-product forms in the production of phthalic anhydride [Austria UBA, 2000 #130].

Oxidation of benzene. Most of the reactors use a fixed bed of catalysts for the reaction, but fluidised bed reactors are also used. All of the different processes for benzene oxidation use similar catalysts based on V₂O₅ (maybe modified with MoO₃). Due to the highly exothermic reaction, normally tube bundle reactors with up to 13000 externally cooled tubes are used. Fused salts are used as circulating heat exchange liquid to remove the reaction heat and to produce steam (approximately 80 % of heat can be used for steam production). The oxidation of the benzene/air mixture takes place at 350 – 450 °C and 1.5 – 2.5 bar with residence times over the catalysts of about 0.1 s and an air excess. For separation of maleic anhydride from the reaction gas mixture the reaction gas is cooled in several heat exchangers. In the last cooler the temperature is below the condensation temperature of the anhydride and 50 to 60 % of the anhydride is obtained directly from the reaction gas mixture. The remainder is washed out with water in the product recovery absorber in the form of maleic acid. The 40 % maleic acid is converted to maleic anhydride, usually by azeotropic distillation with xylene. Some processes may use a double effect vacuum evaporator at this point.

Environmental issues
Air: The product recovery absorber vent contains CO, CO ₂ , benzene, formaldehyde maleic acid and formic acid –the benzene is recovered by adsorption (e.g. on activated carbon) and re-used in the production process. Fugitive emissions of benzene, maleic acid and maleic anhydride also arise from the storage and the handling of these substances. Emissions of xylene from the vacuum pumps and the xylene-stripping column.
Water: The xylene content of effluent is extracted in a xylene-stripping column. Waste water treated in central biological facilities.
Energy: Highly exothermic reaction.

Oxidation of butene: The principle of butene oxidation is very similar to the oxidation of benzene. Again fixed bed tube reactors with a catalyst based on V₂O₅ are used. The reaction takes place at 350 – 450 °C and 2 – 3 bar. Important by-products of this reaction are CO₂, CO, formaldehyde, acetic-, acrylic-, fumaric-, crotonic- and glyoxylic acids. A process variant uses a V₂O₅-H₃PO₄ catalyst in a fluidised bed and has the advantage of easier heat removal at constant reaction temperatures. In contrast to benzene oxidation in the work up no partial condensation of maleic anhydride takes place. The reaction gas is washed with dilute aqueous maleic acid solution. The dilute maleic acid solution is concentrated under vacuum or with the help of water entraining agents. The exhaust gas contains 10 to 20 % of the initial hydrocarbons that could be removed by incineration. The emission from the dehydration units has to be taken into account.

Oxidation of butane: N-butane is the most economic raw material for maleic anhydride production. The process conditions are similar to those for benzene oxidation. Again the catalysts are based on vanadium oxides, but they differ in the promoters such as phosphorus and the oxides of Fe, Cr, Ti, Co, Ni, Mo etc. Fixed bed as well as fluidised-bed processes (e.g. ALMA process) are used. Exothermic reaction heat is removed from the reactor producing high-pressure steam. There are emissions from the dehydration units. Reactor exhaust gas (after scrubbing) is combusted as it contains unreacted input material butane and carbon monoxide.

PHTHALIC ANHYDRIDE is manufactured by the gas (or liquid) phase catalytic oxidation of ortho-xylene (or naphthalene) with air. The reactor gases are cooled and crude product de-sublimes in condensers before vacuum distillation to the required purity. The off-gases are either water scrubbed or incinerated [Environment Agency (E&W), 1999 #7] [Austria UBA, 1999 #65] [InfoMil, 2000 #83].

Environmental issues
Air: Off-gas from the switch condenser scrubber, containing phthalic anhydride, maleic anhydride, various acids, sulphur dioxide and carbon monoxide. Combustion products from incinerated residues and overheads from the distillation columns. Special control techniques include the wet scrubbing of switch condenser off-gases, with recovery of maleic anhydride by processes such as azeotropic dehydration; catalytic incineration of scrubber tail gas, or condenser off-gas if no scrubber is installed; incineration or fuel use of all hydrocarbon residues.
Water: Acidic scrubber liquor from the switch condenser off-gas scrubber or waste water from maleic anhydride recovery.
Wastes: Solid organic residues from distillation columns and stills.

WASTE WATER ISSUES FOR OXYGENATED COMPOUNDS. A survey of German oxygenated processes quantifies the volume of waste water arisings and COD/AOX loads after any pre-treatment but prior to biological treatment (**Error! Reference source not found.**). The survey also gives the pre-treatment techniques used to make waste waters amenable to biological treatment (Table 3.11).

Product	Waste water volume (m ³ /t product)				COD (kg/t product)				AOX (g/t product)				
	<0.1	0.1 - 1	1 - 10	>10	<0.1	0.1 - 1	1 - 10	>10	<0.1	0.1 - 1	1 - 10	10 - 100	>100
Formaldehyde (oxide process)	X				X								
Formaldehyde (silver process)	X				X								
MTBE / tertiary Butanol / Butene		X			X								
Ethylene oxide		X					X						
Phenol		X					X						
Propylene oxide (by chlorohydrin process)				X				X					X
Acetic acid		X						X					
Ethylene glycol / Propylene glycol		X					X						
Phthalic anhydride			X				X						
Adipic acid			X				X						
Acrylic acid / Acrylate ester		X			X								
Acetaldehyde (by ethene oxidation)			X					X					
Acetaldehyde (via ethanol)			X					X					
2-Ethyl hexanol		X				X							
Isopropanol			X				X						
Ethanol			X			X							
Bisphenol A		X				X							
Glycolether		X			X				X				
Methyl-methacrylate		X					X						
Acetic anhydride / Acetic acid		X					X						
Ethyl acetate		X				X							
Methylethylketone	X				X								
Chloroacetic acid			X				X						X
1,4-Butandiol / Formaldehyde			X					X					
Maleic anhydride			X				X						
Cyclohexanol / cyclohexanone		X					X						

Note: Figures Include all emissions except rainwater and cooling water blowdown.

Table 3.10: Quantification of waste water arisings from oxygenated processes [UBA (Germany), 2000 #88]

Product	Treatment technique						
	Incineration	Stripping	Distillation	Extraction	Sedimentation & Flocculation	Hydrolysis	Adsorption
MTBE / tertiary Butanol / Butene			X				
Ethylene oxide		X					
Ethylene glycol / Propylene glycol	X						
Acrylic acid / Acrylate ester	X						
Acetaldehyde (by ethene oxidation)			X				
2-Ethyl hexanol			X				
Bisphenol A			X	X			
Acetic anhydride / Acetic acid			X				
Maleic anhydride	X						
Cyclohexanol / cyclohexanone				X			

Table 3.11: Non-biological treatment techniques for oxygenated process waste waters [UBA (Germany), 2000 #88]

3.5 Nitrogenated compounds

Section 4.1d of Annex 1 to the IPPC Directive considers “*nitrogenous compounds such as amines, amides, nitrous compounds, nitro compounds or nitrate compounds, nitriles, cyanates, isocyanates*”. From this list, an illustrative process was chosen for the production of Acrylonitrile (a nitrile) and this is described in Chapter 11. Although not a consensus decision of the TWG, detailed information is also provided on the process for the production of Toluene Diisocyanate (a cyanate) in Chapter 13.

Table 3.12 gives Europe’s most important nitrogenated organic products (in tonnage terms). The table also indicates what type of process description is provided in the BREF (if any).

Product	Production capacity (kt per year)	Process description?
Nitrobenzene	1218	
Acrylonitrile	1130	Illustrative process
Caprolactam	1095	√
Aniline	839	√
MDI	832	√
Adiponitrile	500	√
Hexamethylene diamine	440	√
TDI	413	Illustrative process
Melamine	270	√
Methyl amine	248	√
Ethanol amine	223	√
Ethylene amine	138	√
Acrylamide	114	√

Table 3.12: Nitrogenated organics with European production capacities in excess of 100 kt/yr [UBA (Germany), 2000 #89] based on Standard Research Institute (SRI) data, Directory of Chemical Products Europe, Vol. II, 1996

3.5.1 Amines

Amines are derived from ammonia by replacing one or more of the hydrogen atoms with alkyl groups. Amines are classified as primary, secondary, or tertiary depending on whether one, two or three hydrogen atoms are replaced.

3.5.1.1 Aliphatic amines

ETHANOLAMINES: All three ethanolamines, monoethanolamine (MELA), diethanolamine (DELA) and triethanolamine (TELA) are produced concurrently in the exothermic reaction of ethylene oxide and ammonia. The reaction is carried out at an elevated temperature and pressure, with excess ammonia to ensure complete conversion of the ethylene oxide. The need for a catalyst is dependent upon the reactor operating conditions. The relative distribution of ethanolamines in the crude reactor product can be varied in response to market demand. A high ratio of ammonia to ethylene oxide is used when MELA and DELA are required. MELA and DELA are recycled if DELA and TELA are the desired products [Environment Agency (E&W), 1999 #7].

ETHYLAMINES & ISOPROPYLAMINES are usually produced on the same plant on a campaign basis. Primary, secondary and tertiary ethylamines are produced concurrently but the tertiary isopropylamine is limited by steric hindrance. Diethylamine is generally the most important product, but the manufacture of the various products is governed by the relative market demands and the ability to recycle surplus product. A basic reactor system design is used world-wide with variations on the associated distillation system. Ethylamines/isopropylamines are manufactured by the gas-phase reaction of anhydrous ammonia and either ethanol or isopropanol at elevated temperature and pressure in the presence of a hydrogenation catalyst (e.g. Raney nickel) [Environment Agency (E&W), 1999 #7].

METHYLAMINES: The unit process of ammonolysis is important in the production of amines, especially the methylamines of monomethylamine (MMA), dimethylamine (DMA) and trimethylamine (TMA). Methylamines are produced in equilibrium in the catalysed vapour-phase alkylation of ammonia with methanol at 260 - 320 °C and a pressure greater than 20 barg. The exothermic reaction is carried out over a fixed-bed of amorphous silica-alumina catalysts. The crude reaction mixture consists of excess ammonia, mono-, di- and trimethylamines, reaction water and uncovered methanol, and is usually purified in a distillation train [Environment Agency (E&W), 1999 #7].

Environmental issues
Air: Process vents that contain methylamines are routed via an absorption system to enable recovery (in a stripper) and recycling. Due to the low odour threshold of MMA, DMA and TMA, leaks are minimised through the good design of storage and handling facilities, seals on pumps, and the minimisation of flanges in pipe work. Bio-treatment or incineration may be necessary as back-up systems to remove odour.
Water: Waste water is generated in the reaction and arises from scrubber water purges (containing soluble amines and ammonia). Water use in the scrubbing systems is minimised. Biological treatment of waste water.
Wastes: Spent catalyst.

QUATERNARY AMMONIUM SALTS: The alkylation of amines forms quaternary ammonium salts (general formula $R^4N^+X^-$ where X is typically a halide ion; R is an aliphatic or aromatic group). Amines react with an alkyl halide to form the next higher amine in the series and the reaction can proceed to the final stage to produce the quaternary salt. Trimethylamine (TMA) is reacted with ethylene dichloride (EDC) to produce the chlorinated quaternary salt as an aqueous solution. The process involves the exothermic, batch reaction of the two liquid feeds, with an EDC excess, carried out at 2.5 barg and 100 °C [Environment Agency (E&W), 1999 #7].

3.5.1.2 Aromatic amines

ANILINE: One of the most important aromatic amines is aniline. It is produced either by the reduction of nitrobenzene (the Bechamp process) or by the catalytic hydrogenation of nitrobenzene (in the gaseous or liquid phase). The production of nitrobenzene and aniline are often integrated [Environment Agency (E&W), 1999 #6].

Environmental issues
Air: NO _x emissions are often controlled by caustic scrubbing prior to discharge to atmosphere. Vent gases (mainly methane and hydrogen) have a high calorific value and can be used as fuel or incinerated.
Water: Alkali water ('red water') is particularly toxic and contains nitrophenols and picrates that leach from the organic phase during washing. Typical concentrations range from 1000 to 10000 ppm. Various abatement techniques have been employed including wet air oxidation, incineration and charcoal adsorption followed by incineration. The acidic water stream is usually managed in a conventional bio-treatment plant after neutralisation.
Wastes: Catalyst residues (copper/silica) are either disposed of by landfill or recycled.

CYCLOHEXYLAMINE: Aniline may be subsequently used to produce cyclohexylamine by the liquid-phase hydrogenation of aniline in the presence of a catalyst (cobalt, nickel or ruthenium/palladium) [Environment Agency (E&W), 1999 #6].

ETHYLENEDIAMINE: The production of ethylenediamine (1,2-diaminoethane) first involves the reaction of ethylene dichloride (EDC) and ammonia to form the intermediate diethylene

triamine hydrochloride. The intermediate is neutralised with sodium hydroxide and converted into amines, salt and water. Ethylenediamine is separated by crystallisation and distillation, whilst the ammonia and sodium hydroxide are recovered. The by-products are diethyl triamine (DETA), higher polyamines and ammonium salts. Vinyl chloride is also formed due to the partial decomposition of EDC [InfoMil, 2000 #83].

An ethylenediamine process in Sweden does not use chlorinated reactants. The plant is run in two continuous stages. In the first stage monoethanolamine (MEA) is formed from ethylene oxide and ammonia, and in the second MEA is again reacted with ammonia to form ethylene amines. Ammonia that has not reacted is recirculated in each stage. Intermediate and final products are purified by distillation.

MELAMINE (2,4,6-triamino sym-triazine) is used to produce melamine resins, glue and decorative surfaces, either from dicyanamide or urea [Austria UBA, 2000 #95].

- dicyanamide can be exothermically converted to melamine in a liquid phase (using, for example, a methanol solvent mixed with ammonia, or liquid ammonia) but this requires the recovery and cleaning of solvents. In the solid phase reaction the main problem is to remove reaction heat and so minimise by-product formation and prevent melamine decomposition
- melamine is produced from urea either under high pressure or using catalysts in a highly endothermic reaction. Much of the urea is decomposed to ammonia and carbon dioxide, and is recovered, most obviously for urea production. The process variants that use high pressure include the Allied Chemicals process, the Montecantini process and the Nissan process. The Catalytic low-pressure processes include the Chemie Linz process, Dutch-Staatsmijnen Process and the BASF process.

3.5.2 Amides

Amides are characterised by an acyl group (-CONH₂) attached to an organic e.g. Formamide (HCONH₂), Carbamide (Urea).

ACRYLAMIDE is manufactured by the reaction of acrylonitrile and water in a continuous stirred tank reactor operating at 100 °C and 4 barg and with a copper-based catalyst. Hydrogen is used to activate the catalyst. Product is steam stripped from the resulting aqueous solution. Unreacted acrylonitrile can be recycled within the process to give almost complete chemical conversion [InfoMil, 2000 #83].

Environmental issues
Air: Acrylonitrile. Residual atmospheric emissions are treated in a scrubber.
Water: Copper from catalyst after separation by precipitation / flocculation.
Wastes: AMD polymer, Copper sludge, waste water treatment sludge.
Energy: Exothermic process. Energy recovery is practised.

UREA (CO(NH₂)₂) is mainly used in the production of: fertiliser; additives to agricultural fodder; resins and glues (condensation reactions with formaldehyde); melamine; dyes; and varnishes. Urea is produced by the exothermic reaction of liquid ammonia and liquid carbon dioxide at high pressure (200 - 250 bar) and temperature (160 – 200 °C) to form ammonium carbamate. The use of ammonia and carbon dioxide raw materials can be optimised by recovery and recycle, and ‘Total Recycle’ processes now exist (either by conventional recycle or by stripping). The ammonium carbamate decomposes endothermically at lower pressure to urea and water. The urea solution is concentrated to molten urea in an evaporator (short residence times are used to minimise decomposition to ammonia and cyanic acid). Alternatively the urea

is crystallised and subsequently separated from the solution by centrifuge. The urea melt or urea crystals can be used as raw material for different products, or prilled or granulated into solid product. Newer plants tend to use granulation as the large volumes of cooling air used in prilling towers create a significant air emission [Austria UBA, 2000 #93]. Further information may be found in the BREF on Large Volume Inorganic Chemicals and in the EFMA's (European Fertiliser Manufacturer's Association) booklet titled 'Production of Urea and Urea Ammonium Nitrate'.

Environmental issues
Air: Exhaust gas from the prilling or granulation system contains ammonia and urea dust. This requires abatement with wet scrubbers, dry dust collectors or electrostatic precipitators. The efficiency of ammonia removal can be improved by using an acid washing solution, but this prevents recycling of the solution in the production process. The process for concentrating the urea solution creates an off-gas containing ammonia and carbon dioxide.
Water: The process reaction produces approximately 300kg water per tonne of urea, mainly in the evaporation unit. Ammonia and carbon dioxide contaminants are removed by stripping or by distillation. A hydrolyser decomposes the urea contaminants into NH ₃ & CO ₂ (for process re-use).

3.5.3 Nitrous / nitro / nitrate compounds

The two main nitration reactions are the nitration of aromatics and the production of explosives [Environment Agency (E&W), 1999 #6]. There are a number of issues whatever combination of agent/reaction is used, namely:

- there is a great diversity of raw materials and products
- large amounts of acid gas are evolved from the process
- large excesses of acid are used to drive the reaction
- gas streams are formed that are rich in oxides of nitrogen (NO_x). These may be diluted with air to convert the NO into NO₂ and this can be treated in a scrubber containing weak caustic soda. Alternative techniques are recovery, via absorption in nitric acid, and SCR
- cyclones are often used to remove surplus liquid.

In **aromatics nitrations**, the reactor is charged with an organic material plus a nitrating agent (often a 'mixed acid' of sulphuric acid/nitric acid) [Environment Agency (E&W), 1999 #6]. A wide range of operating conditions may be used but typically atmospheric pressure and 100 °C. On completion of the reaction, the mixture is quenched in water or ice (possibly in a separate vessel). Releases from the reactor may include:

- acidic vapours (largely nitric or sulphuric acid) from the reaction and quenching
- unreacted nitrating agent arising from the use of excess to drive the reaction
- VOC emissions
- acidic waste waters.

In the separation stage, the quenched mixture is separated using pressure filtration. Releases from this activity may include:

- filtrate contaminated with unreacted raw material and acid. Some may be recycled, most is neutralised with lime to form gypsum. Reprocessing of the filtrate to recover sulphuric acid is more common and is environmentally preferable
- dilute acidic wash waters (from washing the product on the filter) that will require neutralisation.

In **explosives nitrations**, glycerine or cellulose is nitrated in a reactor with mixed acid at about 0 °C. This evolves nitrogen oxide off-gases. The resulting chilled emulsion is separated and washed with water and sodium carbonate. Spent acid from separation is distilled to obtain the nitric and sulphuric acid components. This may generate releases of nitric acid and sulphuric acid from distillation, and acidic waste waters.

3.5.4 Nitriles

Acrylonitrile is the most commercially important nitrile product and is considered in detail as an illustrative process.

ADIPONITRILE is an intermediate in the synthesis of nylon. It can be produced by the hydrocyanation of butadiene, or the electro-hydrodimerisation of acrylonitrile. The electro-hydrodimerisation of acrylonitrile is carried out in reactors that contain lead-plated carbon steel electrodes. The crude adiponitrile stream is vacuum distilled to produce a product stream and high/low boiling fractions for incineration. A crystalliser is used to reclaim the majority of the phosphate and borate species from the electrolyte. The aqueous phase from the crystalliser is sent for lead removal in which sodium-hydrogen sulphide is added to form a lead sludge for separation by centrifuge [Environment Agency (E&W), 1999 #7].

HEXA-METHYLENEDIAMINE: Adiponitrile may be catalytically hydrogenated to produce hexa-methylenediamine (HMD) either by a high-pressure process or a low-pressure process. In the high-pressure process, liquid ammonia is used to suppress the formation of by-products and, with typical hydrogenation temperatures of 80 - 150 °C, this results in operating pressures in the range 200 - 340 barg that maintain the ammonia in the liquid phase. In the low-pressure process, alcohols and/or an aqueous alkali are used to suppress the formation of by-products. The hydrogenation catalyst may be a catalyst slurry or a fixed bed of reduced cobalt, iron, ruthenium or Raney nickel [Environment Agency (E&W), 1999 #7].

3.5.5 Cyanates / isocyanates

Cyanates and isocyanates contain the radical $-NCO$. Mono-isocyanates are used commercially, but the term usually refers to diisocyanates.

DIPHENYL METHANE DIISOCYANATE (MDI) is a raw material for the production of polyurethane resins [InfoMil, 2000 #83]. MDI is produced by the phosgenation of diamino diphenyl methane (DADPM). The production of the phosgene and DAPM raw materials is highly integrated into the process. Phosgene is prepared continuously from chlorine gas and carbon monoxide over a carbon catalyst, and then condensed. DADPM is prepared from formaldehyde and aniline with a hydrochloric acid catalyst. After the reaction, HCl is neutralised with caustic soda, and the resulting sodium chloride brine is gravity separated from the DADPM for effluent treatment. Methanol inhibitor in the formaldehyde leaves with the process water. The DADPM is water-washed to remove salt traces and stripped with steam / nitrogen to remove aniline residues. Aniline is condensed and stored for re-use in the DADPM production. The non-condensables from the aniline recovery and the reactor vent gases are sent to the waste gas treatment unit. The DADPM product is stored prior to phosgenation.

In the phosgenation section, condensed phosgene is absorbed in monochlorobenzene (MCB) and passed to the phosgenation reactor for reaction with DADPM. The reaction gas consists of mainly HCl and phosgene and is recycled to the absorption column. The off-gases from the absorption column (mainly HCl from the phosgenation reactor and some carbon monoxide) are diverted to the HCl recovery section where HCl is compressed and exported.

The crude MDI mixture is separated from the MCB solvent in three steps. Firstly, the MDI mixture is thermally degassed. The recovered phosgene is returned to the absorption column of the phosgenation section and the recovered MCB is stored for re-use. Secondly, the MDI mixture is purified in a vacuum system and de-chlorinated (to remove HCl) by nitrogen stripping. Here the generated gases are sent to the waste gas treatment unit. The recovered MCB is stored for re-use. In the MCB recovery some phenyl isocyanate is also recovered. The phenyl isocyanate is converted to a MDI isomer and ends up as part of the polymeric MDI product, which contains several MDI isomers. In the splitting section the MDI mixture is split into pure 4,4' MDI, mixed isomers and polymeric MDI (all of them useful products).

The waste gas treatment section deals with the process vents and vapours from the MCB, HCl and aniline storage. The vents from the DADPM section and the HCl and aniline storage are cooled to condense and recycle DADPM vapours. The uncondensed gases are treated in a caustic scrubber prior to emission to the atmosphere. The other vents from MCB storage, the MDI / MCB separation section and the MDI splitting section are refrigerated and subsequently led to a water and serial caustic scrubber prior to release to the atmosphere. Scrubber liquids are treated in the process water treatment unit.

The process water treatment consists of two parts. The first part, the amine-brine section, treats the DADPM, methanol, aniline and phenol-containing brine from the DADPM section. Phenol is a contaminant in the raw material aniline. Methanol is recovered through fractionation and exported. DADPM and aniline are recovered for re-use through extraction (DADPM in aniline), gravity separation and steam stripping (last stage removal of aniline and methanol prior to discharge of process water). The waste water from this unit is discharged to the central biological waste water treatment plant. The second part of the process water treatment deals with scrubber drains and rainwater and removes MCB through gravity separation and steam stripping. The recovered MCB is returned to the MCB storage. The treated water is discharged to the central biological waste water treatment plant.

Environmental issues
Air: Waste gas emissions from the waste gas treatment units. Fugitive emissions. All raw materials, intermediates and auxiliary products such as MCB, aniline, DADPM, carbon monoxide and HCl are recovered for re-use. Process vents and vents from HCl, aniline, DADPM and MCB tank storage are treated in water and / or caustic scrubber prior to discharge to atmosphere.
Water: Liquid extraction is applied to remove DADPM. Steam strippers are installed to remove aniline and MCB from process and scrubber water discharges to the biological waste water treatment plant. The most important contaminant is phenol.
Wastes: Methanol and halogenated waste from the recovery of MCB from certain off-spec materials are incinerated.
Energy: Phosgene, DADPM and MDI production are exothermic processes but not to the extent that heat recovery options such as steam generation can be applied.

3.5.6 Other

CAPROLACTAM (hexamethyleneimine) is the main raw material for the production of polyamide-6 (nylon). Caprolactam is produced via the intermediate cyclohexanone (keto-hexamethylene) some of which is used as a solvent in the production of paint. A caprolactam production unit typically consists of four stages [InfoMil, 2000 #83]:

- 1) Cyclohexanone (ANON) plant: Cyclohexanone is produced catalytically from phenol and hydrogen. By-products are cyclohexanol and residues (tar). Cyclohexanol is converted into cyclohexanone whilst generation of hydrogen takes place. Tar is incinerated for heat generation purposes. Waste gas from the reactors contains hydrogen and methane. Methane is an impurity of the hydrogen gas. The waste gas is used as site fuel gas system or flared.
- 2) Hydro xylamine phosphate oxime (HPO) plant: Oxime, the basic intermediate for caprolactam production, is produced via the phosphate route. This utilises two circular counter current liquid streams of an inorganic liquid (ammonium nitrate, phosphoric acid and water) and an organic stream (mainly consisting of toluene).
- 3) Hydro xylamine sulphate oxime (HSO) and caprolactam purification plant: Oxime from the HSO route plus the oxime from the phosphate route are converted to caprolactam via the sulphate route.
- 4) Caprolactam finishing plant: Caprolactam is extracted with benzene. A water wash then removes ammonium sulphate and organic impurities. The remaining benzene is evaporated in a stripper. Further purification is achieved by ion exchange, by catalytic hydrogen treatment, by evaporation and by distillation

Environmental issues
<p>Air: The cyclohexanone plant has emissions of cyclohexanone, cyclohexanol, benzene, cyclohexane from tank vents and vacuum systems. The HPO plant has emissions of cyclohexanone from tank vents and vacuum systems; toluene tank vent emissions; NO_x and NO₂ from the catalytic NO_x treatment unit. The HSO plant has emissions of cyclohexanone and benzene from tank vents and vacuum systems; SO₂ emissions; NO_x and NO₂ from the catalytic NO_x treatment unit. Waste gases from the HPO and HSO plants are used as fuel or flared. Waste gases with nitric oxide and ammonia are converted to nitrogen and water over a catalyst. Benzene tanks are connected to a vapour destruction unit. Vents on oleum, phenol and ammonia storage tanks are equipped with water scrubbers. Balancing lines are used to reduce losses from loading and unloading.</p>
<p>Water: After effluent stripping with steam, the main residual contaminants are caprolactam, cyclohexanone and oxime, and effluent can be treated biologically. The main TOC loads are from the cyclohexanone production. For the manufacture of caprolactam from cyclohexanone, specific water volume is in the range of 0.1 - 1 m³/t and the COD load is 1 - 10 kg/t. Although Ammonia can be separated as a saleable product, effluents may still contain considerable ammonia loads that can be reduced by biological nitrification / denitrification.</p>
<p>Wastes: Tar from cyclohexanone production is incinerated. Catalysts are recovered.</p>
<p>Energy: Waste heat recovery is widely applied.</p>

PYRIDINE (N(CH)₅) is manufactured world-wide by the catalysed ammonolysis of acetaldehyde and formaldehyde. **Methylpyridine** is a by-product of the 2,2-bipyridyl manufacturing process, which involves the use of pyridine. **Dimethylpyridine** a batch fraction can be produced as a by-product from a wet pyridine recovery plant.

WASTE WATER ISSUES NITROGENATED COMPOUNDS. A survey of German nitrogenated processes quantifies the volume of waste water arisings and COD/AOX loads after any pre-treatment but prior to biological treatment (Table 3.13). The survey also gives the pre-treatment techniques used to make waste waters amenable to biological treatment (Table 3.14).

Product	Waste water volume (m ³ /t product)				COD (kg/t product)				AOX (g/t product)				
	<0.1	0.1 - 1	1 - 10	>10	<0.1	0.1 - 1	1 - 10	>10	<0.1	0.1 - 1	1 - 10	10 - 100	>100
Nitrobenzene		X			X					X			
Acrylonitrile			X				X						
Caprolactam		X					X				X		
Aniline (hydration of nitrobenzene)			X				X			X			
Aniline (reduction with iron)			X			X							
TDA			X					X					
TDI (+phosgene)			X				X					X	
Ethanol-amine		X					X						
MDA			X				X						
MDI (+phosgene)		X			X					X			

Note: Figures include all emissions except rainwater and cooling water blowdown.

**Table 3.13: Quantification of waste water arisings from nitrogenated processes
[UBA (Germany), 2000 #88]**

Product	Treatment technique						
	Incineration	Stripping	Distillation	Extraction	Sedimentation & Flocculation	Hydrolysis	Adsorption
Nitrobenzene		X		X			
Acrylonitrile	X		X				
Caprolactam							
Aniline (hydration of nitrobenzene)		X	X				
Aniline (reduction with iron)			X	X			
TDA	X	X		X			
TDI (+phosgene)	X						
MDA			X	X			

**Table 3.14: Non-biological treatment techniques for nitrogenated process waste waters
[UBA (Germany), 2000 #88]**

3.6 Halogenated compounds

Annex 1 to the IPPC Directive does not elaborate on what products might be considered halogenated but Table 3.15 gives Europe's most important halogenated organic products (in tonnage terms). The table also indicates what type of process description is provided in the BREF (if any).

Product	Production capacity (kt per year)	Process description?
1,2-Dichlorethane (EDC)	10817	Illustrative Process
Vinyl chloride (VCM)	6025	Illustrative Process
Methyl chloride	466	
Perchloroethylene	434	
Methylene chloride	321	
Chloroform	318	
Epichlorohydrin	290	√
Allyl chloride	244	√
Chloro benzene	233	
Tetrachloromethane	205	
Trichlorethylene	202	
Ethyl chloride	107	

Table 3.15: Halogenated organics with European production capacities in excess of 100 kt/yr [UBA (Germany), 2000 #89] based on Standard Research Institute (SRI) data, Directory of Chemical Products Europe, Vol. II, 1996

Chlorinated products have most commercial importance, and there are few large volume brominated products. The most commercially important halogenation reaction is the production of ethylene dichloride/vinyl chloride (EDC/VCM) and this is considered in detail as an illustrative process in Chapter 12. Other commercially or environmentally important halogenation reactions are:

- the further chlorination of EDC to trichloroethylene and perchloroethylene
- hydrochlorination of methanol to methyl chloride (and further chlorination to methylene chloride)
- hydro-fluorination of chlorocarbons (e.g. chloroform) to hydrochlorofluorocarbons (HFCs).

Halogenation processes are typically large-scale plants where an organic feedstock is reacted with halogen or halide in a pressurised continuous reactor at elevated temperature in the presence of a catalyst. A range of halogenated organic products is formed, which are separated by condensation and distillation in a train of columns depending on the complexity of the mixture. Unwanted by-products are recycled to the process where possible. Unreacted halogen and halide are recovered and returned to the process or other productive use wherever practicable. Where it is necessary to vent a gas stream, the release of VOCs is abated by an appropriate technique (e.g. incineration, adsorption). Emergency vents are directed to a collection system with suitable abatement facilities. Residues such as heavy ends from distillations are incinerated and not released to land.

Although halogenation is characterised by a very wide variety of reaction options, a number of environmental issues are associated with virtually all options, namely [Environment Agency (E&W), 1999 #6]:

- the potential for release of organo-halogens to the air, water and land environments
- the potential for formation of dioxins
- sophisticated storage and handling techniques may be required
- halide and halogen gases are formed and require abatement by water and/or caustic scrubbing.

The choice of halogenating agent is obviously dependent on the reaction chemistry, but a consideration of the strengths and weaknesses of the alternative agents gives an insight into some generic factors in their use (Table 3.16).

Halogenating agent	Advantage(s)	Disadvantage(s)
Chlorine	Many reactions will generate only gaseous by-product streams, which are easily removed from the off-gas. On completion of the reaction, only small amounts of chlorine usually remain.	Sophisticated storage and handling facilities are normally required.
Bromine	As for chlorine. Can be contained in small, easily handled containers.	As for chlorine.
Iodine	Readily available. Does not require sophisticated storage facilities.	Charging of the solids to the reaction vessel may require special solids handling equipment. Difficulties with certain waste disposal routes.
Thionyl chloride Sulphuryl chloride	Many reactions will generate gaseous by-product streams, which are most easily removed from the off-gas. Readily available in containers up to 200 litres. Does not require sophisticated storage facilities.	Reacts violently with water, alcohols, etc. On completion of the reaction, considerable excess quantities can remain and these have to be removed by distillation. Removing the reaction product may be difficult.
Phosphorus tri- and penta-chloride	Readily available in containers up to 150 litres and in bulk. On completion of the reaction, may be removed by filtration.	Charging of solids to the reaction vessel may require special solids handling equipment. Effluent containing phosphorus compounds may require specialist treatment. Reacts violently with water and fumes on contact with moist air.
Aluminium chloride	Readily available. Does not require sophisticated storage facilities. Can be used to carry out chemical reactions to produce substances that would be difficult to make using other approaches	Evolves fumes readily in contact with moist air, generating hydrogen chloride and aluminium hydroxide. Generates a considerable volume of aqueous effluent containing aluminium salts. This effluent is usually highly acidic. Charging of solids to the reaction vessel may require special solids handling equipment.
Hydrogen halides	Readily available in anhydrous form or aqueous solution. May generate no gaseous by-product.	Sophisticated storage and handling facilities are often required.

Table 3.16: Comparison of halogenating agents
[Environment Agency (E&W), 1999 #6]

Halogenation processes will nearly always involve a reaction vessel (to combine an organic feed with the chosen halogenating agent) and a separation technique (to segregate waste from product). The main releases from reactors will be VOCs (potentially organo-chlorines), halides / halogens, and an aqueous solution of reaction medium (HCl or inorganic salts). Separation processes may create wash waters (from filtration) and VOCs (from evaporation) [Environment Agency (E&W), 1999 #6].

ALLYL CHLORIDE is produced by the chlorination of propylene. The substantial quantities of chlorinated by-products (HCl, dichloropropane, 1,3-dichloropropylene) are separated by distillation and incinerated. HCl is recovered from the incinerator for sale. Waste gases are scrubbed with an alkali liquor and this produces calcium and sodium hypochlorite [InfoMil, 2000 #83]. Some plants may incinerate waste gas and this avoids waste water generation.

CHLORO FLUORO HYDROCARBONS (CFCs) are used as cooling fluids and raw material for production of TFE (tetrafluoro ethylene)-monomer. CFCs are produced from chloroform and

hydrogen fluoride, with help of a catalyst. Hydrogen chloride is formed as a by-product and is purified for sale as a 30 % HCl solution in water [InfoMil, 2000 #83].

Environmental issues
Air: Waste gases are thermally incinerated. A 30 % solution of HF in water is recovered for sale. Chlorine vapours are sent to chlorine destruction. Pollutants are VOCs, aromatic halogenated hydrocarbons, freons, and trichlormethane – mostly from fugitive sources.
Water: Air strippers remove organic compounds (e.g. chloroform) from waste water and pass vapour to incinerator. Main pollutants are inorganic chlorine and fluorine compounds.
Wastes: Used catalyst is regenerated externally.
Energy: Endothermic process.

EPICHLOROHYDRIN is produced by a two-step aqueous phase reaction. In the first stage of epichlorohydrin (chloropropylene oxide) production, allyl chloride and hypochlorite are reacted to produce dichlorohydrin and HCl. In a combined hydrolysis / rectification unit the dichlorohydrin is further reacted with dichloro isopropanol to form epichlorohydrin which is instantly separated from the aqueous solution. The by-products include trichloro propane, tetrachloro propylethers and chloroether [InfoMil, 2000 #83]. The waste water organic load can be reduced by extension of the product rectification column. Lime and other inorganic solids are separated by filtration. The organic load (TOC) mainly consists of glycerine that is easy to biodegrade. As an alternative to biological treatment, the treatment with hypochlorite is applied to remove COD and AOX (reduction 90 % and residual AOX of 3 mg/l). Emissions after treatment are about 3.5 kg COD/ t product, 150 g AOX/t product and 3 g EOX/t product. Application of sodium hydroxide instead of calcium hydroxide in the aqueous process steps may reduce the release of heavy metals and the related toxicity of the waste water effluent.

WASTE WATER ISSUES HALOGENATED COMPOUNDS. A survey of German processes quantifies the volume of waste water arisings and the COD/AOX loads after any pre-treatment but prior to biological treatment (Table 3.17). The survey also records the pre-treatment techniques used to make waste waters amenable to biological treatment (Table 3.18).

Product	Waste water volume (m ³ /t product)				COD (kg/t product)				AOX (g/t product)				
	<0.1	0.1 - 1	1 - 10	>10	<0.1	0.1 - 1	1 - 10	>10	<0.1	0.1 - 1	1 - 10	10 - 100	>100
EDC (by direct chlorination)	X				X				X				
EDC (by oxy-chlorination)		X				X				X			
Methylchloride			X			X				X			
Epichlorohydrin / Allylchloride				X				X					X
Chloro-benzene		X			X						X		
Ethyl chloride			X		X						X		

Note: Figures include all emissions except rainwater and cooling water blowdown.

Table 3.17: Quantification of waste water arisings from halogenated processes [UBA (Germany), 2000 #88]

Product	Treatment technique						
	Incineration	Stripping	Distillation	Extraction	Sedimentation & Flocculation	Hydrolysis	Adsorption
EDC (by direct chlorination)		X			X		
EDC (by oxy-chlorination)		X			X	X	
Epichlorohydrin / Allylchloride		X				X	
Chloro-benzene		X					

Table 3.18: Non-biological treatment techniques for halogenated process waste waters [UBA (Germany), 2000 #88]

3.7 Sulphur compounds

The large and diverse group of sulphur-containing organic compounds does not have an illustrative process in this BREF. Annex I of the IPPC directive gives no examples to explain the term 'sulphurous compounds', but the Paris Workshop [CITEPA, 1997 #47] considered that the group may include "mercaptans, sulphonates, sulphates, sulphur oxides".

Products such as the main thioalcohols may be considered as commodity chemicals. For example, methanethiol is produced at fairly large scale for methionine (for which an EC capacity of 150 kt/yr exists). However, many other products will be produced at less than the nominal 100 kt/yr threshold for LVOC and are confined to specialist producers. Some of the more important products include [EC DGXI, 1992 #23]:

- amino acids containing sulphur: methionine, cysteine
- mercaptans: methanethiol, ethanethiol, butanethiol
- dialkyl sulphides: dimethyl sulphide, diethyl sulphide
- thiuram sulphides: tetramethyl thiuram monosulphide
- acids: thioacetic acid, thioglycolic acid
- dithiocarbamates: dimethyl & dibutyldithiocarbamates
- heterocyclics: thiophene, thiazole
- others: dimethylsulphoxide
- linear alkyl benzyl sulphonates and linear alkylphenyl ethoxylates (APEO) (manufacture of detergents).

Sulphonation reactions may be considered in terms of the sulphonation of aromatics, and the sulphonation/sulphation of aliphatics [Environment Agency (E&W), 1999 #6]. The reactions cover a wide diversity of raw materials and products, but most are typified by the need for a large excess of acid (to drive the reaction) and the evolution of acid gas. Sulphonation often generates a sulphur trioxide (SO₃) rich gas stream, which can be treated in a ceramic-packed scrubber containing 98 % sulphuric acid, followed by a candle filter to eliminate mist [Environment Agency (E&W), 1999 #6].

In the **sulphonation of aromatics**, the reactor is charged with organic material plus the sulphonating agent (often a 'mixed acid' of sulphuric acid/nitric acid). A wide range of operating conditions may be used but typically atmospheric pressure and 100 °C. On completion of the reaction, the mixture is quenched in water or ice (possibly in a separate vessel). Releases from the reactor may include:

- acid vapours (largely sulphuric acid) from the reaction and quenching
- unreacted sulphonating agent arising from the use of an excess to drive the reaction
- VOC emissions
- acidic waste waters.

In the separation stage, the quenched mixture is separated using pressure filtration. Releases from this activity may include:

- filtrate contaminated with unreacted raw material and acid. Some may be recycled, but most is neutralised with lime to form gypsum
- dilute acidic wash waters (from washing the product on the filter) that will require neutralisation.

Sulphur trioxide is often used in the **sulphonation/sulphation of aliphatics**. The reaction generates acidic vapours, VOCs and acidic waste waters. The most important products are the linear alkyl sulphonates (LAS) used in detergents. Waste gas streams may also arise from neutralisation of acid reaction product and any on-site sulphur trioxide production.

CARBON DISULPHIDE is manufactured by the reaction of vaporised sulphur and hydrocarbons (such as methane, ethane, propylene or natural gas). The gas mixture is heated to 580 - 650 °C and pressures between 2.5 - 5 barg to produce carbon disulphide and hydrogen sulphide. Uncondensed carbon disulphide is recovered from the hydrogen sulphide by absorption in odourless kerosene, followed by steam stripping, and the combined carbon disulphide streams are purified by distillation. The hydrogen sulphide is converted back to sulphur in a Claus plant [Environment Agency (E&W), 1999 #7].

Environmental issues
Air: Carbon disulphide and hydrogen sulphide are steam-stripped from the stabiliser feed drum overflow and sent to the flare system. Gases leaving the absorber column contain hydrogen sulphide, sulphur and carbon disulphide, and pass through a wire-mesh filter to remove entrained droplets before sulphur recovery in a Claus unit. The carbon disulphide surge tank vent is kept live with a methane (natural gas) blanket and this leads to a continuous discharge (possibly contaminated with carbon disulphide) to the flare system. Compressed air is used to strip carbon disulphide from the surge tank catch pot overflow, and the resulting gas stream will require treatment if it contains a significant concentration of carbon disulphide. Odourless kerosene from the production plant may be used to absorb carbon disulphide vapours emitted during the filling of tankers. Jacketed pipework from sulphur condensers discharges to the flare stack. During furnace start-up, a methane feed is established, and sulphur slowly brought on-line until the desired conversion is achieved.
Water: The aqueous layer from the stabiliser feed drum is degassed with steam and passed to a catch pot to which cold water is added. A purge of the lean oil system is completed to prevent the build-up of sulphur compounds and this is stripped using a polysulphide caustic liquor.
Wastes: The sulphur filters are coated with diatomaceous earth and this is periodically removed (together with some sulphur and inorganic impurities).

DITHIOCARBAMATES are produced by the reaction of an aqueous alkaline solution of secondary or tertiary amines with carbon disulphide. Aqueous dithiocarbamates can be added to an aqueous metal salt to produce a metal dithiocarbamate slurry that is then filtered and dried. Zinc, nickel and copper dithiocarbamates are the main products [Environment Agency (E&W), 1999 #7].

ETHYL PENTACHLOROTHIOPHENE (EPCT) is produced by the reaction of phosphorus pentasulphide and ethanol to form diethyldithiophosphoric acid (DETA). DETA is chlorinated to produce EPCT and a sulphur precipitate [Environment Agency (E&W), 1999 #7].

Environmental issues
Air: Breathing releases from the ethanol storage tank are released directly to the atmosphere. Off-gases from the reactor are incinerated with contaminated combustion air drawn from the building caustic scrubber discharge and storage tank vents.
Water: Spent scrubber liquor is discharged frequently. Hydrochloric acid (32 %) is generated in the adsorber (water scrubber) from hydrogen chloride fumes and either sold commercially or used to neutralise alkaline liquid waste streams.
Wastes: Cartridges from the DETA filter are collected and sent for off-site disposal. The residues generated in the chlorination are discharged to steel drums and allowed to cool before sealing and landfill disposal.

THIOLS can be manufactured by a number of processes [Environment Agency (E&W), 1999 #7]. Ethanethiol is prepared by the vapour-phase reaction between ethylene and hydrogen sulphide over an acid catalyst. Methanethiol is similarly prepared from the corresponding alcohol. Other primary thiols are prepared by the UV-light-promoted addition of hydrogen sulphide to primary alkenes. Tertiary alkanethiols are prepared from the corresponding tertiary alkene and hydrogen sulphide, in a continuous flow reaction over a solid catalyst. Thiophenol is prepared by the red phosphorus reaction of benzenesulphonyl chloride, or by the high-

temperature reaction of monochlorobenzene and hydrogen sulphide. Process equipment and storage vessels for thiols are constructed of carbon steel, aluminium, stainless steel or other copper-free alloy. Thiols stored in carbon steel are kept dry and blanketed with an inert gas to prevent the formation of iron sulphur complexes. Rubber is not suitable for hoses or gaskets.

Environmental issues
Air: The opening of drums prior to charging into reactors creates vapours that are locally extracted and passed to carbon adsorbers or incineration. Used drums are gently heated in a drum decontamination plant and the extracted vapours are adsorbed, incinerated or caustic scrubbed. Blending tanks are vented to a carbon adsorber, incinerator or caustic scrubber. Road tankers are equipped with a carbon adsorber to remove residual odours. Spent tanker wash-down methanol is usually incinerated.
Water: The final water flushing of tankers containing unspent hypochlorite is discharged to effluent treatment.
Wastes: Effluent treatment sludges and filter-cakes containing dithiocarbamates and other sulphur complexes are sent to landfill.

THIOPHENE: There are three commercial processes for the production of thiophene. One route is the vapour-phase reaction of furan and hydrogen sulphide over a hetero-polyacid-promoted metal oxide catalyst at 300 - 400 °C. The second route, is the continuous reaction of carbon disulphide and C₄ compounds (1-butene, butadiene, n-butanol and 2-butenal) over an alkali-promoted metal oxide catalyst at 500 °C. The third process involves the continuous reaction of butane and sulphur at 500 - 600 °C over a mixed metal oxide catalyst [Environment Agency (E&W), 1999 #7].

3.7.1 Generic issues in the production of sulphur compounds

The following techniques are relevant to most processes involving organic chemicals containing sulphur [Environment Agency (E&W), 1999 #7]:

Waste gases:

- waste process gases are likely to contain hydrogen sulphide and, where practicable, undergo sulphur recovery
- during normal operation, waste streams containing mainly carbon disulphide are adsorbed in odourless kerosene. The resulting stream containing hydrogen sulphide, sulphur and carbon disulphide can be incinerated to give sulphur dioxide as well as carbon oxides and water vapour. Methods to minimise the release of sulphur oxides are considered. Where appropriate, sulphur recovery units are installed upstream of any incineration equipment
- contaminated extraction air can be dealt with most easily by incineration. Otherwise, carbon or biological filters may be considered. Amine, caustic scrubbing or other systems may be appropriate for particular releases
- odour problems are particularly prominent in the manufacture of thiols and other organic sulphur compounds. Adsorption beds and bio-filters may be used to eliminate odours from fugitive releases in enclosed areas
- cyclones are often used to remove surplus liquid from gas streams
- many sulphur compounds have low odour thresholds and conventional equipment designs (e.g. flanged pipework, centrifugal pumps) may have an unacceptable level of releases. This results in the use of all-welded pipework, canned pumps and scrubbing equipment.

Effluents:

- liquid effluents will originate from scrubbing systems, process wastes and routine cleaning of equipment. The effluents may contain carbon disulphide, or hydrogen sulphide, mercaptans or other organic sulphur compounds
- effluents are likely to require primary and secondary treatment prior to discharge to the environment

- steam or air stripping can remove contaminants such as hydrogen sulphide and carbon disulphide and prepare the effluent for biological treatment, but the resulting off-gas will require sulphur recovery or incineration
- aqueous wastes contaminated with kerosene (carbon disulphide process) will require oil separation. Where possible, contaminated kerosene is regenerated on-site by stripping with a polysulphide caustic liquor
- spent scrubber liquors can be treated with hypochlorite to form inert chlorates of sulphur. The use of hypochlorite or other easily handled oxidant (such as hydrogen peroxide or ozone) may be considered for the elimination of odours in effluent.

Wastes:

- wastes are likely to contain organic sulphur compounds. Operators may need to ensure that the sulphur compounds are removed prior to the landfilling or that the wastes are suitably contained to prevent the release of the sulphur component and to limit odours.

The **recovery of sulphur** from process vents is important both for process efficiency and environmental protection. Recovery is usually based on scrubbing using different absorbents in a variety of different contacting methods. Some of the absorbents are described below [Environment Agency (E&W), 1999 #7].

- **Mono- or diethanolamine** (e.g. methyl-diethanolamine, MDEA) reacts with hydrogen sulphide and carbon dioxide to form inert compounds. The amine absorbent passes counter-current to the sour gas in a packed column producing sweetened gas for further treatment. The rich amine stream is transferred to a feed drum, which also separates entrained hydrocarbons. Amines have good absorption efficiency and can be tailored to suit particular waste streams. The same hardware configuration can also be operated with a **potassium carbonate** absorbent.
- In order to avoid the degradation losses suffered by MDEA solutions, the solvent **sulfinol** may be used. The sulfinol solution usually consists of 40 - 45 % sulfolane (tetrahydrothiophene dioxide), and 40 - 45 % diisopropanolamine. Sulfinol provides greater gas-treatment capacity, lower solvent circulation, lower heat requirements, and lower rates of solvent degradation.
- In the **alkazid** process a solution containing the potassium salt of N,N-diethylglycine or N,N-dimethylglycine selectively absorbs hydrogen sulphide, carbon dioxide, mercaptans and small amounts of carbon disulphide, and hydrogen cyanide. The absorbent is thermally regenerated.

Sulphur can be recovered from the absorbent using the **Claus** system. The rich amine stream from the scrubber is first heated in a regenerator column to drive off the hydrogen sulphide. The overheads are cooled, and condensate is recycled to the column. The lean amine stream is recycled to the scrubber and the acid gas (greater than 90 % hydrogen sulphide) is passed to sulphur recovery. In the sulphur recovery unit, part of the acid gas is burnt with air in a furnace to produce sulphur dioxide and water vapour. Further hydrogen sulphide then reacts with the sulphur dioxide to produce water vapour and elemental sulphur. Both reactions occur in the combustion stage and sulphur is condensed for removal from the exit gases. Further acid gas is added in a re-heater and the mixture is passed to the first catalytic stage, containing a fixed bed of bauxite, where the second reaction continues. The reaction is equilibrium-limited and overall conversion of hydrogen sulphide to sulphur depends upon the number of reacting and condensing stages. To achieve acceptable conversion, three stages are required, or two stages and tail gas clean-up. Residual sulphur dioxide and hydrogen sulphide are passed to tail gas incineration before discharge to a vent. Sulphur recovery plants can operate to a recovery efficiency of at least 98 % during normal operation. This will normally require three catalytic conversion stages with a selective catalyst in the final stage (e.g. super-Claus process) or with further treatment of the tail gas (residual sulphur dioxide is reduced to hydrogen sulphide for recycle to the amine scrubbers).

Alternatively, sulphur can be directly recovered from weak hydrogen sulphide streams by **liquid redox** technologies that oxidise hydrogen sulphide to sulphur using the action of a number of mild oxidising agents. In the Stretford process, the gas stream is first washed in an alkaline solution containing dissolved vanadates and anthraquinone disulphonic acids, fixing the hydrogen sulphide. The liquid from the washing stage then passes to a reaction tank, where virtually all the hydrogen sulphide is converted into elemental sulphur. The oxidation stage separates the sulphur from the solution, for return to the washing stage. The sulphur is floated off as a froth and further recovery produces a saleable form. The sulphur is usually recovered from the slurry in a molten form by decantation under pressure, frequently with prior filtration. The vanadium-based Stretford process can achieve removal efficiencies of 99.9 % and the process is tolerant to fluctuating flow-rates. However, the use of vanadium may have undesirable environmental implications, and other processes, utilising non-toxic iron-based catalysts, have been developed.

3.8 Phosphorus compounds

Annex I of the IPPC directive gives no examples to explain the term ‘phosphorus-containing hydrocarbons’. These are a specialised group of products and are of most importance in agricultural insecticides. The sector may include [EC DGXI, 1992 #23]:

- diethyl phosphorodithioate (as used in Phosalone)
- diethyl phosphorochlorodithioate (as used in Demeton, Phoxim, Parathion)
- dimethyl hydrogen phosphorodithioate (as used in Malathion)
- dimethyl hydrogen phosphorothioate (as used in Omethoate).

It is possible that no substances in this sector are produced in excess of the nominal 100 kt/yr threshold for LVOC.

3.9 Organo-metal compounds

Annex I of the IPPC directive gives no examples to explain the term ‘organo-metallic compounds’ and neither did the Paris Workshop [CITEPA, 1997 #47] elaborate upon the term.

The limited information on organo-metal compounds suggests that many are produced below the annual production capacity of 100 Kt/yr that has been nominally chosen to define LVOC.

ORGANO-LEAD, ORGANO-LITHIUM AND ORGANO-MAGNESIUM COMPOUNDS.

Whilst the production of every compound involves a unique approach, there are a number of common issues with the production processes for organo-lead, organo-lithium and organo-magnesium compounds, namely [Environment Agency (E&W), 1999 #6]:

- the reactions are strongly exothermic and require control to prevent emergency venting of the reactor contents
- the reactions are sensitive to the presence of atmospheric oxygen and moisture, which can compromise product quality and, in some cases, can give rise to pyrophoric reactions
- organic solvents are used extensively due to the widespread potential for water to adversely affect the reactions
- the presence of both organic and metal-based pollutants in waste streams and
- a large number of side-reactions that can reduce reaction yields and increase the complexity of wastes.

In addition to these general issues, the production of each type of compound gives rise to a number of specific issues.

There is still a limited market for **lead alkyl** products, particularly outside Europe, but this is constantly declining. All existing processes are based on the batch-wise reaction of lead/sodium alloy with ethyl or methyl chloride. The main issues to note with this type of reaction are as follows [Environment Agency (E&W), 1999 #6]:

- tetramethyllead (TML), but not tetraethyllead (TEL), is unstable on its own and is thus manufactured, stored and sold as an 80:20 mixture with toluene
- a large excess of lead needs to be used during the process, with the result that up to 75 % of the lead is not incorporated into the product and needs to be recovered. Other reagents, (e.g. alkyl chlorides) are also used in excess and need to be recovered
- the reaction usually takes place under pressure to ensure that the normally gaseous alkyl chloride reagent is present in the reaction vessel as a liquid
- TEL can be removed from gas streams by the use of mineral oil-based, packed tower absorbers. TEL is recovered from the oil by stripping under vacuum with heating
- waste waters will typically receive pH adjustment followed by settlement to remove inorganic lead compounds. Lead-rich sludges can be collected and sent for recovery. Soluble organo-lead compounds can be removed by reduction with sodium borohydride or zinc. Alternatively, chemical precipitation can be used followed by adsorption and ozone treatment.

Table 3.19 summarises some of the key process units and sources of releases in the reaction.

Unit	Activity	Main release(s)
Reactor (autoclave)	Reagents are charged to reactor with catalyst where they are refluxed at the desired pressure and temperature (typically 6 bar for TEL and 24 bar for TML and approx. 65 °C for both).	Hydrocarbons and alkyl chloride vented from reflux. Excess alkyl chloride vented off at completion of reaction.
Batch still (reactor)	Reaction mass from autoclave is transferred to a batch still pre-charged with water. TML/TEL is then distilled off by direct steam injection and condensed and collected in a separation vessel.	Remaining alkyl chloride driven off as batch still heated. Still residues (primarily lead, sodium, chloride, sodium hydroxide and alkyl chloride).
Phase separation	Remaining water and impurities are removed from TML/TEL by phase separation.	Lead and other impurities in aqueous stream.
Blending	TML/TEL is blended with a variety of materials to form final product.	Dibromo- and dichloroethane from blending process.
Collection pits	Effluents from the various stages in the process are directed to collection pits for the recovery of lead.	TEL/TML vapours.

Table 3.19: Key process units and releases in lead compound production
[Environment Agency (E&W), 1999 #6]

The most important **lithium** alkyl is n-butyllithium, which is used extensively as an initiator in polymerisation reactions. All commercial production of n-butyllithium is based on the reaction of lithium metal with n-butyl chloride. The most important elements in its production [Environment Agency (E&W), 1999 #6]:

- some reagents and the product are pyrophoric and they also react exothermically with water to form butane gas. The process therefore takes place in a hydrocarbon solvent that excludes moisture and air. The main solvents used are pentane, hexane and cyclohexane
- large amounts of inert gas (nitrogen and argon) are used during parts of the process and these will entrain volatiles
- vents are fitted with oil bubblers to prevent the ingress of air/moisture into the process. Oil from these bubblers may be volatilised and lost to atmosphere
- lithium metal is expensive, and therefore considerable attention is paid to its recovery during the process and from subsequent waste water- treatment.

Table 3.20 summarises the main process steps, release points and substances released.

Unit	Activity	Main release(s)
Reactor	Lithium ingots are melted in mineral oil at 180 - 190 °C and then cooled to form 'clean' finely divided lithium. The mineral oil is drained from the reactor and a hydrocarbon solvent added to wash the lithium. This too is drained from the reactor to form a lithium dispersion.	Mineral oil drained from the reactor and hydrocarbon wash contaminated with lithium. Hydrocarbon solvent emissions to air.
Reactor	Lithium dispersion is charged to reactor and butyl chloride added at a constant rate.	Hydrogen. Hydrocarbon solvent emissions.
Filtration	Reaction mass is filtered twice. The resulting filtrate is the product.	Filter cake sent for recovery.

Table 3.20: Main process steps in the production of n-butyllithium
[Environment Agency (E&W), 1999 #6]

Organo-**magnesium** compounds are used extensively as Grignard reagents. A wide variety of reactions have been developed to produce specific compounds, but typically these can be viewed as the displacement of a halogen by magnesium from the desired organic group. The most important element of the production of organo-magnesium compounds is that they are always made and used in an organic solvent, typically ethers (e.g. tetrahydrofuran) which provide good solubility. Although a wide variety of different reactions can be used, a typical reaction may consist of the process units, activities and releases outlined in Table 3.21.

Unit	Activity	Main release(s)
Reactor	Solvent and magnesium metal are charged to reactor before the controlled addition of an organo-halide.	Alkyl halide and solvent emissions to air.
Reactor	Reaction mass is transferred to another reactor for the addition of a second organic compound.	Solvent emissions to air.
Distillation	To recover solvent.	Solvent emissions to air. Distillation column bottoms'.
Phase separation	Reaction mass is acidified, with the result that magnesium salts are driven into aqueous phase. Product concentrates in organic phase.	Aqueous phase for effluent treatment.

Table 3.21: Production of organo-magnesium compounds
[Environment Agency (E&W), 1999 #6]

ORGANO-TIN COMPOUNDS.

In 1989 it was reported [EC DGXI, 1994 #24] that only six companies within Europe produced dibutyltin compounds and the highest production rate was a mere 4.4 Kt/yr (at Ciba Geigy AG Hessen, Germany). Such have been the environmental pressures on the use of organo-tin products in the intervening period that current European production is probably even lower. Production is predominantly in multi-purpose batch plants and products are unlikely to meet the criteria for classification as LVOC.

4 GENERIC EMISSIONS

Consumption and emission levels are very specific to each process and so they are difficult to define and quantify unless the process has undergone detailed information exchange. Some estimates of emissions from the organic chemical industry can be found in Table II-5 of [EC DGXI, 1992 #23], but this information is brief and somewhat dated.

Process emissions normally have very specific causes, most importantly [InfoMil, 2000 #83]:

- the raw materials may contain contaminants that pass through the process unchanged and exit with the waste water or waste gas (e.g. the MDI process has emissions that result from the presence of phenol (in aniline feedstock) and methanol (in formaldehyde feedstock))
- the process may use air as an oxidant and this creates a waste gas (mainly consisting of nitrogen) that requires venting to atmosphere (e.g. oxychlorination in the EDC process, methanol oxidation in formaldehyde process, and toluene oxidation in phenol process)
- the process reactions may yield water that mixes with the product (e.g. formaldehyde production), and requires separation (e.g. as in MDI or EDC production)
- by-products may be formed by the process reactions or from unwanted side reactions. The by-products have to be separated from the desired products and can often be used as a raw material (e.g. in low-olefin crackers) or as a fuel
- auxiliary agents may be introduced into the process and not fully recovered (e.g. solvents)
- unreacted feedstock which cannot be economically recovered or re-used.

The character and scale of emissions are highly variable but are often closely related to plant age. Emissions will also depend on such factors as: raw material composition; product range; nature of intermediates; use of auxiliary materials; process conditions; extent of in-process emission prevention and type of end-of-pipe treatment.

The waste streams from each process will also vary over time, depending on the operating scenario. The possible sources of waste arisings therefore require consideration during:

- routine operation (i.e. expected emissions under stable running)
- non-routine operation (e.g. start-up, shutdown, maintenance, decommissioning), and
- emergencies (e.g. fires, explosion).

However, LVOC processes utilise many common activities so it is possible to consider in a generic manner where waste streams may arise and what those streams might contain. The following lists of waste streams are not exhaustive, nor will all streams occur in every process, but this chapter provides a checklist of possible emission sources and components against which a regulator can assess a process to elucidate specific details. Further generic information may be found in the WWVG horizontal BREF [EIPPCB, Draft #48].

4.1 Air pollutants

The Paris workshop [CITEPA, 1997 #47] considered that the air pollution issues of a process were different for:

- batch processes in aqueous solution
- batch processes in solvent systems
- continuous processes in aqueous solution
- continuous processes in solvent systems
- continuous gas phase reactions.

Whilst batch processes are unlikely to apply to LVOC, the other categories are all widely used in the sector.

4.1.1 Emission sources

In Chapter 2 the BREF introduced the idea of a generic process for the production of LVOC. The component parts of that generic process provide a useful structure for identifying the potential sources of air emissions, and some of these are listed below.

Raw material supply and work-up

- vents on distillation columns and stripping columns for removal of impurities in raw materials
- vents on pre-mixing vessels (VOCs, particulates).

Synthesis

- discrete vents serving reaction equipment (e.g. purges, inert vents from condensers, let-down vessels, process scrubbers)
- vents associated with catalyst preparation and catalyst regeneration (containing VOCs, CO_x, NO_x, SO_x)
- relief devices to maintain safe operation (e.g. pressure relief valves, bursting discs).

Product separation and refinement

- vents serving separation equipment (e.g. distillation columns, stripping columns, crystallisers, condensers)
- particulate from drying and handling of solids
- CO_x and VOCs from the regeneration of purification beds
- solvent regeneration.

Product storage and handling

Detailed information on emission sources may be found in the Storage BREF [EIPPCB, Draft #49], but in general terms emissions may arise from:

- tank losses from displacement during filling and breathing during ambient temperature changes (mainly VOCs with rate of loss depending on vapour pressure)
- loading/unloading of containers and vessels (tankers for road, rail and boat)
- blanket gases used in storage tanks
- particulate losses from conveyors
- evaporative losses from spills.

Emission abatement

- waste gas combustion units (e.g. flares, incinerators) may produce secondary pollutants that did not exist in the original waste stream (e.g. dioxins, particulates), as well as combustion gases
- stripping of waste water (with air or steam) will transfer dissolved organics into the gaseous phase
- VOCs from waste water collection systems (e.g. drains, balancing tanks)
- VOCs from waste water treatment facilities (e.g. vaporisation of VOCs in biological treatment units)
- VOCs and particulates from storage and treatment of solid wastes.

Energy / utilities

- combustion units are widely used for raising steam, heat and electricity (e.g. process heaters, furnaces). These will produce the usual combustion gases (e.g. CO_x, NO_x, SO₂, particulates) and other pollutants (e.g. acid gases, dioxins) if wastes are combusted.

Infrastructure

- fugitive losses (especially VOCs) from equipment (e.g. compressors, pumps) and fittings (e.g. flanges, valves)
- cooling water contaminated with process streams (e.g. from equipment leakage) passing through cooling towers
- workspace ventilation is primarily a health and safety issue. Although the pollutant concentrations are very low in ventilation air, there may be significant mass releases to atmosphere because of the high air volumes involved.
- analysers and sampling ports
- equipment evacuation and cleaning in preparation for access (e.g. maintenance).

Management systems

Inadequacies of management systems or failure of operators to adhere to procedures may be source of process upsets or incidents with possible subsequent emissions.

4.1.2 Pollutant types

The main category of air pollutants from the production of LVOC is Volatile Organic Compounds (VOCs), but there may also be significant emissions of particulate matter, acid gases and combustion gases.

4.1.2.1 Volatile Organic Compounds (VOCs)

VOCs emissions are of significant environmental concern because some have the potential for Photochemical Ozone Creation Potential (POCP), Ozone Depletion Potential (ODP), Global Warming Potential (GWP), toxicity, carcinogenicity and local nuisance from odour. The prevention of VOC emissions is therefore one of the most important issues facing the operation of LVOC processes.

The term VOCs covers a diverse group of substances and includes all organic compounds released to air in the gas phase, whether hydrocarbons or substituted hydrocarbons. Their properties, and hence need for control, vary greatly and so systems have been developed to categorise VOCs according to their harmfulness.

The German TA-Luft classification system is used by several Member States as a basis for permitting and national legislation or guidance. It is also the basis for a system developed in the UK [Environment Agency (E&W), 1995 #14] which identifies three classes of VOC and requires a commensurate level of prevention and control for each class. The three classes are:

- extremely hazardous to health – such as benzene, vinyl chloride and 1,2 dichloroethane
- class A Compounds – that may cause significant harm to the environment (e.g. acetaldehyde, aniline, benzyl chloride)
- class B Compounds – that have lower environmental impact.

VOC could also be defined as substances having a vapour pressure greater than 0.3 kPa at 20 °C (which is close to the US definition for the application limits of systematic LDAR). This limit was set by the USEPA based on two facts:

- emissions of heavier products through leaks are normally very low and can be visually detected
- the sniffing method is not adequate for the heavier products.

Some VOCs may also be highly odorous, for example aldehydes, mercaptans, amines and other sulphur-containing compounds. This may necessitate additional stringency in the prevention measures (e.g. high integrity equipment to reduce fugitives) and the abatement of losses.

VOCs typically arise from: process vents; the storage and transfer of liquids and gases; fugitive sources and intermittent vents. Losses are greatest where the feedstock or process stream is a gas; in these cases VOC losses can exceed 2 % of total production [Environment Agency (E&W), 1998 #1]. Point sources of VOCs have been well controlled over recent years and losses of fugitives (from pumps, valves, tanks etc.) have become the major source of VOC emissions from many plants.

Some unit processes (e.g. hydroformylation, chlorination, dehydrogenation, condensation, oxychlorination, hydrochlorination) have reactors with large VOC emission factors but their high calorific values usually make them suitable for abatement in combustion devices. Other unit processes (e.g. ammination, ammonolysis, cleavage, esterification, fluorination, hydration, neutralisation, oligomerisation, phosgenation, pyrolysis, sulphurisation) are reported to have no reactor vents (and hence VOC emissions), but may have significant VOC emissions from subsequent distillation units [USEPA, 1993 #33].

4.1.2.2 Particulate matter

In general, arisings of particulate matter are not usually a major issue in the production of LVOC, but they may derive from such activities as:

- the conditioning of solid raw materials
- the drying of solid products
- catalyst regeneration
- wastes handling.

4.1.2.3 Combustion gases

Combustion gases may originate from primary sources such as process furnaces, steam boilers, turbines and engines, but also from pollutant abatement (e.g. incinerators and flares). Whilst process furnaces are usually dedicated to one process, steam and electricity producing units often serve a complete chemical complex and their emissions cannot be allocated easily to one process.

Combustion units will generate emissions to air that are related to combustion conditions (e.g. CO₂, H₂O, NO_x, C_xH_y, CO, soot) and fuel composition (e.g. SO₂, fuel-NO_x, metals, soot) [InfoMil, 2000 #83].

Common gaseous fuels in the LVOC sector are natural gas and low-boiling gaseous fractions from the processes (e.g. hydrogen, C₁-C₄ hydrocarbons). In general, gaseous fuels combust cleanly and result in the lowest emissions. Gaseous fuels are normally low in sulphur and have a low content of bound nitrogen, and so the SO_x and fuel NO_x emissions from gas firing are relatively low. Emissions may be increased by air pre-heating (higher thermal-NO_x emissions) and sulphur or nitrogen compounds in the fuel (may cause fuel-NO_x and fuel-SO₂ emissions). The high temperatures in so-called 'high temperature process furnaces' may also increase thermal-NO_x emissions.

Liquid fuels may occasionally be used in the LVOC industry. Common liquid fuels are residual higher boiling fractions from the process and industrial gas oil or fuel oil. Emissions depend mainly on the concentration of impurities in the fuel. In particular, 'heavy' liquid fuels may cause emissions of dust and heavy metals (due to ash content), emissions of NO_x and SO₂ (due to nitrogen and sulphur content) and have an increased potential for soot formation.

4.1.2.4 Acid gases

Mainly hydrogen chloride and hydrogen fluoride formed as by-products during halogenation reactions. Potentially releases of halogenating agents as well (e.g. chlorine, bromine).

4.1.2.5 Dioxins

Polychlorinated dibenzodioxins (dioxins), polychlorinated dibenzofurans (furans) and polychlorinated biphenyls (PCBs) may be generated as pollutants from certain production processes that use chlorine. Dioxins can also be emitted from incinerators treating a chlorinated or non-chlorinated feedstock if improper operating conditions are used.

4.2 Water pollutants

The Paris workshop [CITEPA, 1997 #47] considered that the water pollution issues of a process were different for:

- non-aqueous processes
- processes with process water contact as steam, diluent or absorbent
- processes with a liquid phase reaction system
- batch processes where water is used for cleaning operations.

All but batch processes are likely to be used in LVOC production.

4.2.1 Emission sources

Again, the generic LVOC process provides a useful structure for identifying the source of water emissions. For all sources, attention should not only be paid to effluent streams that enter surface waters (rivers, lakes, seas), but also discharges to groundwater – either directly or indirectly (via the contamination of soil). The sources may include:

Raw material supply and work-up

- storage tank overflows
- mixing vessels (e.g. overflows, wash-down).

Synthesis

- water is added (as reactant solvent or carrier)
- reaction water is formed in the process (e.g. from a condensation reaction)
- water is present in the raw material
- process purges and bleeds (especially of ‘mother liquors’)
- quenching of organic vapour streams.

Product separation and refinement

- water is used for product washing and picks up traces of products / wastes
- spent neutralising agents (acid or alkali)
- regeneration of ion exchange resins
- solvent recovery.

Product storage and handling

Detailed information on emission sources may be found in the Storage BREF [EIPPCB, Draft #49], but in general terms emissions may arise from:

- tank overflow
- spills during loading/unloading
- leakage from tanks and pipe systems
- spillage from drums and IBCs.

Emission abatement

- effluents may utilise neutralising agents (acid or alkali)
- air abatement systems (e.g. spent scrubber liquor)
- dewatering of sludges
- water bleed from seals drums and knock-out drums.

Energy / utilities

- hydrocarbon contamination of water cooling systems (e.g. from equipment leakage)
- bleed on boiler feed water (containing corrosion-inhibitors, biocides and scale)
- bleed on water demineralisation plant
- cooling system blowdown
- steam condensate contaminated with raw material, product, or waste (e.g. from equipment leakage).

Infrastructure

- cleaning operations (washing of vessels, pipes and other equipment to facilitate access e.g. for maintenance purposes)
- fire-fighting water
- rain water run-off from roofs and hardstanding
- diffuse sources (e.g. leaks, spills from process equipment)
- oil from mechanical equipment (compressors etc)
- contamination of condensate from steam ejectors used to create vacuum
- water gland seals on vacuum pumps
- vapour condensates in pipe runs
- general site effluents from offices, canteens, laboratories and workshops
- water-curtains for hydrocarbons containment and /or acid gases absorption.

Management systems

Emissions may occur from process upsets or incidents that are attributable to the inadequacies of management systems or the failure of operators to adhere to procedures.

4.2.2 Pollutant types

The nature of pollutants in effluents is very specific to the process, but several generic effluent characteristics are encountered in LVOC processes:

- mixtures of oil/organics in water. Oils are so widely used in processes that they pose a high risk of contaminating effluents. Other organic contaminants may arise from raw materials, by-products and the use of solvents. These may occur as an emulsion or a distinct phase
- biodegradable organics (typically as measured by BOD)
- recalcitrant organics that are not amenable to conventional biological degradation. This may be measured by tests such as Chemical Oxygen Demand (COD), Total Organic Carbon (TOC), Adsorbable Organic Halogens (AOX) or Extractable Organic Halogens (EOX)
- volatile organics
- heavy metals – resulting from use of catalysts
- nitrogen-compounds (NH₄-N, NO₃-N, NO₂-N) and phosphate – where used in a process
- acid / alkaline effluents
- suspended solids
- heat.

4.3 Wastes

4.3.1 Emission sources

Wastes are very specific to a process, but the key pollutants in wastes can be derived from: knowledge of the process; materials of construction; corrosion/erosion mechanisms and materials related to maintenance. In generic terms wastes may include:

Raw material supply and work-up

- off-specification raw materials.

Synthesis

- spent catalyst and catalyst support. Catalysts may become spent because of chemical deactivation, physical degradation or fouling. The composition of catalysts varies greatly and is often subject to a high level of confidentiality. Many are based on expensive, exotic metals and this prompts recovery (either on or off site)
- wastes on shutdown (e.g. organic residues)
- corrosion and erosion products inside equipment (e.g. oxides of iron and other metals).

Product separation and refinement

- spent purification media. A variety of media are used to remove impurities such as water or unwanted side products (e.g. activated carbon, molecular sieves, filter media, desiccants, ion exchange resins)
- unwanted by-products
- process residues (e.g. heavy organic residues from distillation columns (e.g. tars and waxes), sludges in vessels). May have value as a by-product, feedstock for another process or as a fuel
- spent reagents (e.g. organic solvents – these may be valuable to recover/re-use, or to use a fuel to capture the calorific value)
- off-specification products.

Product storage and handling

Detailed information on emission sources may be found in the Storage BREF [EIPPCB, Draft #49], but in general terms emissions may arise from:

- waste packaging (e.g. spent drums, sacks)
- product polymerisation in tanks.

Emission abatement

- adsorbents used for spill clean-up
- solids produced by the abatement of air pollutants (e.g. dust from electrostatic precipitators, bag filters)
- solids produced by the abatement of water pollutants (e.g. catalyst solids settled from waste water, filter cake).

Energy / utilities

- ashes / soots from furnaces, heaters and other combustion equipment.

Infrastructure

- decommissioned plant equipment
- construction materials (e.g. metal, concrete, insulation)
- general site wastes from offices, canteens and laboratories
- spent cleaning agents (e.g. phosphoric acid)
- spent oils (lubrication, hydraulic etc)
- spent heat transfer fluids.

Management systems

Emissions may occur from process upsets or incidents that are attributable to the inadequacies of management systems or the failure of operators to adhere to procedures.

4.3.2 Pollutant types

The form of wastes may range from discrete solid items to highly fluid sludges with significant water content. The nature of wastes is very dependent on the process. Wastes may be hazardous due to the presence of toxic organic substances or heavy metals.

4.4 Factors influencing consumption and emissions

Some of the emission and consumption data in this BREF shows considerable ranges and this makes the comparison of plant performance very difficult. Much of this variability is explained by the influence of a number of factors. An understanding of these factors is important for interpreting emission and consumption data from LVOC processes and so brief explanations follow [CEFIC, 2000 #110].

4.4.1 Plant boundary definition and the degree of integration

Plants are usually described as being made up of equipment and process units that are 'ISBL' (inside battery limits) and 'OSBL' (outside battery limits). These definitions are not rigorous and may depend on the nature of the overall facility within which the plant is located.

At some sites associated production activities may be directly associated with the process under scrutiny, but at other sites the same activities may be undertaken in separate facilities (i.e. physically remote and /or operated by another company).

LVOC processes typically require the principle utilities (steam, power and cooling water) and provision for waste water / waste gas treatment. In only a limited number of cases are LVOC plants totally independent, standalone units with dedicated services. More typically, LVOC plants are part of an integrated petrochemical and/or refining complex, where common utilities are provided by central facilities (e.g. dedicated power, steam generation plant, effluent treatment and flaring facilities).

Integration with other units also allows certain low value or potential waste streams to be recovered and utilised, or processed into saleable products thus eliminating the requirement for disposal.

4.4.2 Definition of emission basis

Despite the frequent requirement on producers to provide emission figures to regulatory authorities, there is no standard basis on which the figures are quoted. The figures may be actual emissions or just typical levels. Likewise, the figures may, or may not, include emissions from events such as major plant upsets, emergency releases, overhauls, start-ups and slow-downs. Other reporting inconsistencies arise from whether waste is subsequently recycled or processed downstream by the producer himself or a third party, or whether the waste is regarded as 'hazardous' or 'non-hazardous' by local definition.

4.4.3 Measurement technique

The absence of standardised methods for measuring and reporting emissions makes direct comparison difficult. Many components are difficult to measure and are frequently reported by reference to a calculation method that may be based on empirical, model or design information.

For example, non-channelled (fugitive) emissions may be reported on the basis of direct measurements or estimates based on a technique that counts the number of emission point sources (flanges, valves, pumps etc.) and applies standard emission factors relating to the contained fluid. Likewise the combustion of hydrocarbons at a flare tip may not be 100 % efficient, but there is no practical way of determining the level of unburned hydrocarbons. The use of different measurement and reporting methodologies can lead to very different apparent emission levels for similar activities.

4.4.4 Definition of waste

Definition of what constitutes a 'waste' can have a significant effect on reported emissions and subsequent plant comparisons. For example, in some facilities site rain water is classified as waste because it passes through the same treatment facility as process waste water. Solid waste generation and disposal is particularly complex as many operators are required to provide complete information on: special wastes, other hazardous wastes, spent catalysts and desiccants, scrap metal, packaging materials, general rubbish, office and mess room waste materials. Elsewhere, reporting requirements are such that only some of these waste categories are measured and controlled. In some cases, spent catalyst goes for off-site regeneration and/or precious metal recovery, rather than disposal, and is difficult to evaluate. Likewise, highly integrated sites may appear to have less waste as they have more opportunities for upgrading waste streams into products.

4.4.5 Plant location

Plant location can have an impact on the process flow scheme and as a result, on the nature and quantity of emissions. This is normally the result of local environmental considerations or constraints and the effect of cross media environmental aspects. For example, a plant in a coastal location may utilise seawater for process cooling on a once-through basis, greatly affecting the specific volume of waste water from the unit. Such a plant may also be able to separate sulphur compounds, which must be eliminated from the process and convert these to sulphate, using a wet air oxidation, or acid neutralisation process. The resulting aqueous effluent may be acceptable for discharge to the marine environment but plants located next to inland watercourses will need to incinerate the concentrated sulphur-bearing stream. Sulphur dioxide emissions in the former case are zero, whilst in the latter all the contained sulphur is discharged as SO₂.

5 GENERIC TECHNIQUES TO CONSIDER IN THE DETERMINATION OF BAT

This chapter of the BREF normally provides a catalogue of techniques that can be used to prevent and control emissions from the process in question, but this is not possible in the absence of a detailed information exchange for all LVOC processes. Instead, this section provides an overview of generally available techniques and their application to LVOC processes. In reading this chapter, reference should also be made to relevant horizontal BREFs, especially the BREF on Common waste water / waste gas management and treatment which describes the techniques that are used across the whole chemical industry.

In most cases, processes will achieve environmental protection by using a combination of process development, process design, plant design, process-integrated techniques and end-of-pipe techniques. The implementation of some techniques may be easier on new plants, whilst other techniques can be adopted on existing plants. The chapter therefore considers techniques involving: management systems; pollution prevention techniques; and pollution control techniques for air, water and solid wastes.

5.1 Management systems

In order to minimise the environmental impact of LVOC processes, it is necessary to appreciate the central role of effective management systems. The purchase of state-of-the-art hardware does not automatically guarantee the best environmental performance since it must also be operated correctly. Likewise, the limitations of older equipment can often be mitigated by diligent operation. The best environmental performance is usually achieved by the installation of the best technology and its operation in the most effective and efficient manner. This is recognised by the IPPC directive definition of “techniques” as *“both the technology used and the way in which the installation is designed, built, maintained, operated, and decommissioned”*.

An Environmental Management System (EMS) is that part of the overall management system which includes the organisational structure, responsibilities, practices, procedures, processes and resources for developing, implementing, achieving, reviewing and monitoring the environmental policy [InfoMil, 2000 #83]. Environmental Management Systems are most effective and efficient where they form an inherent part of the management and operation of a process. There is no definitive EMS and the choice of techniques must be tailored to the specific circumstances of each site.

Environmental Management Systems can provide a number of advantages, both internal and external, for example [InfoMil, 2000 #83]:

- improved insight into the environmental aspects of the company
- improved basis for decision making
- improved motivation of personnel
- additional opportunities for operational cost reduction and product quality improvement
- improved environmental performance
- improved company image
- reduced liability, insurance costs and non-compliance costs
- increased attractiveness for employees, customers and investors
- improved relationship with authorities and environmental groups.

Effective environmental management involves a commitment to continuous environmental improvement through a cyclical system of: gathering and analysing data; establishing objectives; setting targets; measuring progress and revising the objectives according to results.

This systematic approach may be aided by the adoption of formal management standards such as the Eco Management and Audit Scheme (EMAS) [EC, 1993 #41] or ISO 14001.

The following sections provide information on management techniques that have already shown benefits to the environmental performance of LVOC processes. The list of techniques is not exhaustive and it includes many practices that will be considered common sense in well-managed installations. However, it has been observed that 'well managed' installations usually display good environmental performance as well as profitability, whilst the converse often applies [Environment Agency (E&W), 1988 #5] [Environment Agency (E&W), 1999 #7].

5.1.1 Management commitment

There are two steps involved in the commitment of management to excellence in environmental performance. The first step is the formulation of an environmental/sustainable strategy by the highest management of a company and, secondly, the commitment of this management to follow the strategy. Many environmental strategies exist, but the commitments required by CEFIC's 'Responsible Care'[®] initiative [CEFIC, 1999 #17] provide a good framework for the implementation of management techniques. The key aspects of this initiative are that:

- there is a commitment to conform with statutory regulations as a minimum and work with authorities to develop and implement measures where needed
- employees and contractors are aware of the commitment and are involved in its delivery
- there is an open dialogue both inside and outside the organisation
- all health, safety and environmental impacts of activities, products and processes have been identified and considered.

This commitment to environmental improvement can be demonstrated to a wider audience by the publication of corporate (or installation-specific) environmental reports. Such reports might cover the compliance with legal requirements, performance against targets and planned improvements.

Some companies have not only adopted formal management commitments such as Responsible Care but also complementary and more far-reaching visions that internalise 'green thinking' to enhance environmental and sustainable operation. These might include, for example, strategies for the use of renewable energy sources, benchmarking of energy efficiency and innovative re-use of waste, waste water and waste gases both inside and outside the site fence.

5.1.2 Organisation and responsibility

It is necessary to involve all tiers of management in order to ensure good environmental performance. Clear organisational structures ensure that the management of environmental issues is fully integrated into a company's decision-making systems. The aim is to engender an employee culture where the consideration of environmental issues is an inherent part of employee thought-processes in just the same way as safety or cost.

This requires that all employees understand their duties and responsibilities with respect to environmental protection. Correspondingly, management must ensure that processes are adequately manned in terms of the number of operators, their technical expertise and their experience.

Written procedures have a fundamental role in good performance and should be prepared for all the important aspects of plant operation. The writing of procedures does not, *per se*, deliver performance and systems should be in place to ensure that procedures are understood and complied with. Activities that have historically shown higher risks (e.g. poor communication

during shift changes) may need to be targeted with more detailed procedures. The procedures should be subject to quality control and should be periodically reviewed to reflect the learning of plant operation.

There should be a well-understood disciplinary procedure for dealing with any acts of gross negligence by employees. However, this needs to be balanced against the desire to encourage the open debate of operating errors so that incidents are investigated and remedied.

Other good practices that may have a role include:

- establish a contingency plan to identify the potential process incidents and provide guidance on incident response
- establish procedures to identify, respond to and learn from all complaints and incidents
- establish a clear contact point (of sufficient seniority) to ensure overall 'ownership' of environmental issues
- develop installation-specific environmental objectives in addition to the corporate objectives
- include environmental objectives in annual performance assessments of employees
- make environmental considerations a standard agenda item at all meetings.

The effectiveness of these systems can be assessed by monitoring overall environmental performance of the process. Monitoring results may also be considered on a regular basis (preferably against agreed performance indicators) and form part of the management assessment process.

5.1.3 Training

Appropriate training should be given to all staff involved in process operation to ensure that they are competent for their duties. The training should include the environmental implications of their work and the procedures for dealing with incidents. Staff should be familiar with the requirements of all environmental permits and understand how their activities may affect compliance. Records should be kept of the training given to staff and these should be reviewed periodically to ensure that they reflect the needs of the job.

There may also be a role for less formal modes of training and information transfer to employees. For example, notice boards, cascade briefings and in-house magazines can be used to disseminate environmental performance data. Positive involvement can also be encouraged by suggestion schemes that reward innovative approaches to environmental issues.

5.1.4 Process design and development

Companies should work to written standards and procedures when modifying existing installations or designing new plant. As a minimum this should follow the requirements of any national and international technical codes for materials, equipment design and fabrication. All design decisions or modifications should be recorded in order to provide an audit trail.

The provision of research and development (R&D) facilities has an important role in the development of cleaner technologies. Environmental protection should be an inherent feature of the design standards since techniques incorporated at the earliest possible design stage are both more effective and cheaper. Initial process design should consider how fundamental principles (addition, substitution, deletion and redundancy/duplication) may be applied to process materials, process variables and equipment in order to prevent releases [Noyes, 1992 #35]. For example, the consideration of 'substitution' in the context of 'process materials' may identify an opportunity for using a less toxic chemical. Or, duplication might involve the use of a second thermocouple to measure a particularly critical temperature. Such process modifications have been shown to reduce the severity of operating conditions, the quantities of toxic materials, and the complexity of the process, and to enhance process control.

In spite of good design and operation, abnormal operating conditions will occur on all plants. Since emissions are usually much higher during abnormal operating conditions, it is important to minimise the number and duration of such events. Abnormal operating conditions can arise for a variety of reasons, for example: loss of energy supply; activation of safety valves due to high pressure; disturbances in production plants or environmental protection systems; or incorrect operation.

The impact of abnormal operating conditions can be minimised by using hazard and risk analyses to identify the physical and chemical eventualities that could occur in all component parts of the process (e.g. high pressure, high temperature). If this analysis identifies that critical ranges can be reached, then safety provisions must be made. These provisions can consist of technical measures (e.g. safety valves) and/or management systems (e.g. shutdown procedures). The technical measures may include:

- connection of safety valves to flares or knock-out vessels
- provision of emergency holding tanks on effluent drains to protect waste water treatment plants from toxic spills
- provision of secondary containment on production units.

The UK [Environment Agency (E&W), 1999 #6] has also provided guidance which recommends that the design of new and existing processes should be critically reviewed to ensure that the following practices have been followed.

- review the environmental implications of all raw materials, intermediates and products
- identify and characterise all planned and potential unplanned releases
- segregate wastes at source (to facilitate their re-use and treatment)
- treat waste streams at source (to exploit high concentration / low flow streams)
- provide containment for spills
- minimise fugitive losses with high integrity equipment
- provide flow and load buffering
- install back-up abatement systems where appropriate
- assign to wastes their full cost of treatment and disposal.

Plant design should also give consideration to the environmental impact from the eventual decommissioning of the unit as forethought makes decommissioning easier, cleaner and cheaper. Decommissioning poses environmental risks for the contamination of land (and groundwater) and generates large quantities of solid waste. The preventative techniques are process-specific but general considerations can be found in [Hicks, 2000 #84]. These may include:

- avoid underground structures
- include features that facilitate physical dismantling (e.g. cut-points, lifting eyes)
- choose surface finishes that are easily de-contaminated
- use an equipment configuration that minimises trapped chemicals and facilitates drain-down/washing
- design flexible, self-contained units that enable phased closure.

The specific approach to Environmental, Health and Safety activities in a process plant project will vary from company to company. Annex VII describes a specific example from Finland [Finnish Environment Institute, 1999 #62].

5.1.5 Industrial planning and logistics

As well as considering the techniques that are used within a process, it is also important to consider the wider opportunities provided by the interaction between a process and its surroundings (so called 'Industrial Ecology' [InfoMil, 2000 #83]). New plants provide good opportunities for optimising the location and logistics, although the issue is more directly related to spatial planning. Examples of issues to explore when planning a new plant are:

- distance to customers and suppliers (especially for toxic or hazardous components)
- heat integration with neighbouring companies or activities
- recycling or re-use of unwanted by-products or wastes by neighbouring companies
- sharing of utilities or environmental facilities (e.g. Combined Heat & Power units, waste water treatment plants, oxygen/nitrogen plant)
- infrastructure (e.g. pipeline connections versus road, railroad or water transport)
- spatial zoning (with regard to safety, noise, odour, traffic etc.).

5.1.6 Process control

Efficient process control, to achieve stable operations and high yields, is important to achieve good environmental performance. The operator should be able to demonstrate that the process is being adequately controlled under all modes of operation (i.e. routine operation, start-up, shutdown, and abnormal conditions). The operator should identify the key performance indicators and methods for measuring and controlling these parameters. The key parameters are usually flow, pressure, temperature, composition and quantity.

All operational modes should be covered by procedures to ensure the effective and efficient use of control systems. The procedures should be subject to periodic review to reflect practical observations and experience.

The process should be equipped with a level of instrumentation that enables monitoring of the key operational parameters. Process monitoring data should be recorded and stored to provide adequate information for diagnostic purposes. Modern control systems like DCS (Distributed Control Systems) or PLC (Programmable Logical Computers) provide process monitoring, allowing swift corrective action and/or automatic safe shut down in case of deviation from steady-state conditions.

The start-up and shutdown of units often results in poor process efficiency and this causes higher emission rates than during routine operation. This should be recognised in the design of the units and the sizing of environmental protection systems. The number of start-up and shutdown events should be minimised through the optimisation of production planning.

Staff should be aware of the environmental implications of abnormal events and how to reconcile these with the overriding need to maintain plant safety. Staff should be trained to deal with abnormal operating conditions and should practise the responses using realistic exercises.

Abnormal operating conditions should be documented and analysed to identify the root causes. The root causes should be addressed with techniques to ensure that events do not recur. This learning exercise can be facilitated by a 'no-blame' culture where the identification of causes is more important than apportioning blame to individuals.

Sites for the production of LVOC often fall under the scope of the 'Seveso II' (COMAH) directive [EC, 1996 #32]. The implementation of Seveso II is beyond the legal remit of IPPC, but the IPPC directive (at Article 3d) requires the operation of installations to involve the necessary measures to "prevent accidents and limit their consequences".

The Seveso II directive requires the preparation of a 'safety report' that sets out an operator's policy for the prevention of major accidents and the mechanisms to ensure that it is implemented. The major-accident prevention policy aims to protect people and the environment by appropriate means, structures and management systems and the policy is required to take account of the principles in Annex III of the Seveso directive.

5.1.7 Maintenance

The maintenance of process plant and equipment is an essential part of good operation and will involve both preventative and reactive approaches.

Preventative maintenance plays a very significant role in optimising environmental performance and it is often the preferred approach. A structured programme of preventative maintenance should be established after detailed consideration of equipment failure frequencies and consequences. The maintenance programme should be supported by appropriate record keeping systems and diagnostic testing. There should be clear responsibility for the planning and execution of maintenance.

The need for reactive maintenance can be minimised by employee vigilance in relation to imminent problems (e.g. process upsets and leaks). Leak Detection and Repair programmes can also play an important role.

Equipment cleaning is a widespread maintenance activity that removes undesirable deposits (reaction residues, corrosion products, scale etc). Cleaning may be achieved by chemical means (a solvent such as water or a weak acid) or by mechanical methods (scrapers, pigs etc). The associated waste streams can be minimised by reducing the need for cleaning (i.e. the frequency) and reducing the quantity of deposits that accumulate. Special attention should be paid to the collection of wash-water from equipment that is removed for cleaning elsewhere (i.e. *ex-situ*).

Equipment modifications during maintenance are a frequent occurrence on many plants and should be covered by procedures that only give authorisation after a suitable level of risk assessment. Subsequent process start-up should be dependent on suitable post-modification checks.

5.1.8 Monitoring

Monitoring has been identified as a common activity across IPPC processes and is the subject of a horizontal BREF titled 'Monitoring of Emissions' [EIPPCB, Draft #51]. The document provides generic information on sampling and analysis, and should be read in conjunction with the BREF on LVOC.

Monitoring is an essential activity in the operation of LVOC processes, but it is often expensive and time consuming so the objectives should be clear when a programme is drawn up. Process operators and regulators may use monitoring to provide information on such topics as:

- Process control and optimisation. Monitoring is the way used to control a process by means of following-up significant physical and chemical parameters. By control of the process, it is meant the application of conditions in which the process operates safely and economically. Process parameters change rapidly and this usually necessitates continuous surveillance with associated alarms and process trips.

- Monitoring of external treatment efficiency. End of pipe treatment efficiency may be guaranteed by the equipment provider or stipulated in a permit. Good treatment efficiency is generally a result of good operating practice and requires training and experience. The interdependence between process control and arising waste streams on one hand and treatment efficiency and outgoing emissions on the other should be well known.
- Emission monitoring. Emissions to air and water (and arisings of solid waste) are characterised and quantified to provide a check on compliance with permit requirements (or other performance measures). Subsequent emission reporting provides a check of whether the permit covers all significant emissions (including those in cooling water and storm water). Wherever possible, data should be collected on flow rates to enable the calculation of mass discharges. Provision may also need to be made for monitoring noise and odour.
- Ambient environment quality. Indicator substances can be monitored to assess the impact of a process on the local environment (including air, water, land and groundwater contamination).
- Quality control. Frequent inspection of the quantity and quality of raw material inputs to the process (e.g. sulphur content in fuel oil, water quality) for comparison against specifications.
- Occupational health and safety. Tests to identify the short and long term risks to personnel from work place exposure.
- Troubleshooting. Intensive, short duration programmes may be used to study specific topics.

A monitoring programme to address any of these topics will need to stipulate the frequency, location and method of both sampling and analysis. Monitoring usually involves precise quantitative analysis, but simple operator observations (either visually or by smell) can also play an important role in the detection of abnormal releases. Results of monitoring programmes should be actively used and records of results should be kept for trend analysis / diagnostic use.

5.1.9 Auditing

Operators should not rely solely on the independent auditing carried out by external bodies such as regulators, but should have their own internal systems in place. The frequency, level of scrutiny and scope of audits will vary with the objectives. They may typically be:

- to review the implementation of environmental policies
- to verify compliance with procedures, standards and legal requirements
- to identify the need for new / improved standards, procedures and systems of work
- to promote awareness of environmental protection
- to assess environmental impact of the process.

The auditing should be against agreed performance criteria. Where deficiencies are identified, there should also be recommendations for remedial action. Systems should also exist to ensure that the actions are recorded and implemented. Formal audit guidelines exist in the ISO 14000 series, EMAS and in Member States e.g. [UK CIA, 1991 #39].

5.1.10 Cost awareness & financing

At an operational level, there should be a good understanding of the costs associated with solid, aqueous and gaseous waste production within the process. This can be achieved by using accounting practices that fully attribute the costs of waste disposal and treatment to the originating process (or sub-units of a process).

The process operator should be able to demonstrate that adequate financial resources are being committed to operate the process in accordance with permit conditions and in-house commitments. There should be long term financial planning to fund anticipated environmental investment. Expenditure for solely environmental purposes should be given proper consideration alongside commercial initiatives.

In the commodity chemical business the costs of abatement may reduce business profitability rather than being passed on to customers in selling price [Environment Agency (E&W), 1998 #1]. Waste minimisation initiatives that improve environmental performance as well as reducing costs can therefore be particularly beneficial.

5.2 Pollution prevention

The IPPC Directive definition of best available techniques strongly emphasises the presumption for preventative techniques over other methods. This is very much in keeping with the waste management hierarchy, which advocates;

1. eliminate the arisings of waste through process design
2. reduce wastes at source through changes to equipment and procedures
3. recycle wastes
4. recover any resource value from wastes
5. treat and dispose of wastes.

Sequential consideration should be given to each tier of the hierarchy and only when all the options have been exhausted should attention pass to the next tier. Wastes are progressively avoided at each tier and only wastes that cannot be avoided by prevention and recycling remain for treatment and disposal using 'conventional' end-of-pipe abatement techniques. The waste management hierarchy applies equally well to arisings of gaseous, aqueous and solid wastes.

Many other terms are used synonymously for pollution prevention, for example: process-integrated measures, green chemistry, pollution reduction, source reduction, cleaner production, waste minimisation, waste reduction, clean technology and low-waste technology. All of these phrases refer, essentially, to the concept of providing proactive and more effective environmental protection by integrating pollution prevention and energy efficiency into the production process. This recognises the fact that once waste is created it cannot be destroyed – only modified. Prevention offers a precautionary, rather than curative, approach to environmental protection and is often compatible with 'sustainable development'.

Many companies have already shown that the creative use of pollution prevention techniques not only minimises environmental impact, but also improves efficiency and increases profits. The USEPA has reported that pollution prevention confers many advantages over end-of-pipe treatment technologies (Table 5.1).

Direct Benefits	Indirect Benefits
<ul style="list-style-type: none"> • Lower waste treatment costs (whether in-house or off-site) • Lower disposal charges from regulators • Reduced expenditure on raw materials (due to improved yields) • Cost saving from waste re-use or sale • Reduced environmental compliance costs (from fines & shutdowns) • Lower risk of spills/leaks • Reduced secondary emissions from waste treatment facilities • Retention (or possible enhancement) of market share for products 	<ul style="list-style-type: none"> • Reduced likelihood of future costs from remediation, legal liabilities and complying with future regulations • Improved relations with local community and wider public • Increased environmental awareness of process operators and management • Improved health of employees and neighbours

Table 5.1: Benefits of pollution prevention
[USEPA, 1995 #12]

There is a vast range of pollution prevention techniques covering both hardware and software. Their application is very process-specific, but the USEPA has broadly classified them according to Figure 5.1. These principles can be applied at any stage in the life of a process, although the best opportunities arise in the design of a new process on a new site. New processes allow for the implementation of the latest technology, optimised heat integration, optimised logistics and process control, and an optimised package of process-integrated and end-of pipe techniques. The opportunities for pollution prevention in existing processes are more limited but the structured approach of a 'waste minimisation initiative' can identify options.

The principles of these generic prevention techniques are described in the following sections, but no attempt is made to provide a definitive list because of the need to consider local factors. In any choice of technique it will be necessary to give consideration to the full effects of any process changes to ensure that they do not create new waste streams or adversely affect product quality. More examples of preventative techniques in chemical processes are given in references [USEPA, 1995 #12], [Nelson, 1992 #45] and [Smith & Petela, 1991 #46].

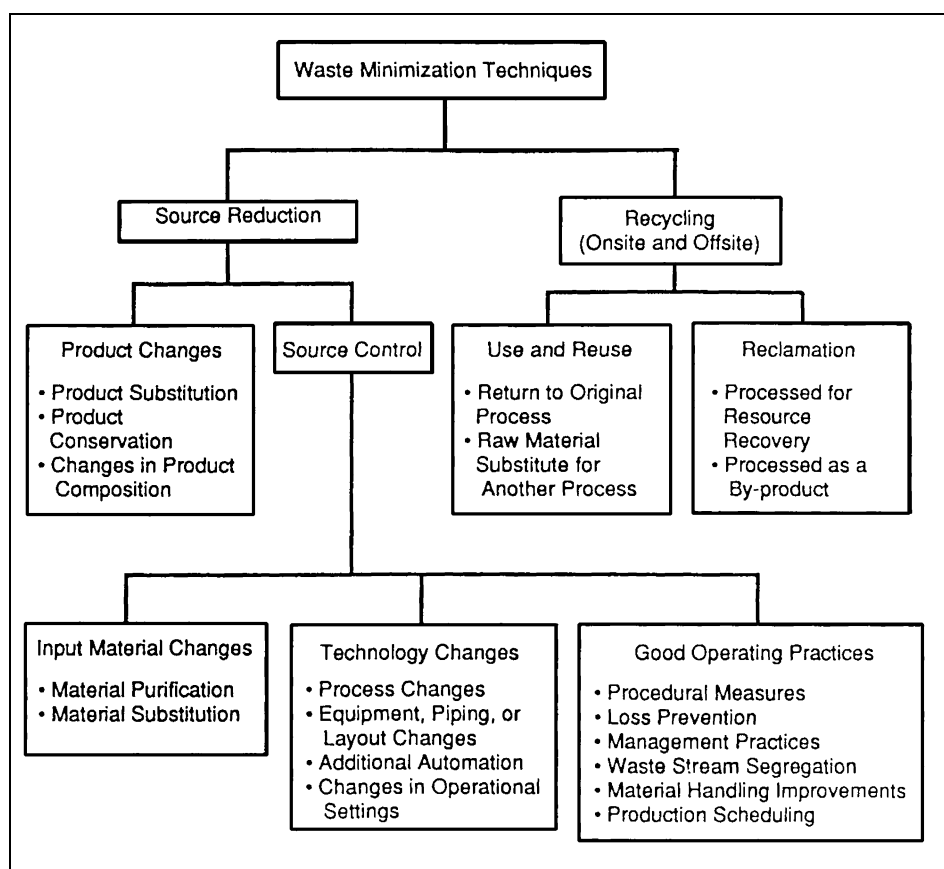

Figure 5.1: Waste minimisation techniques
[USEPA, 1998 #42]

5.2.1 Source reduction

Source reduction techniques are concerned with preventing the arising of wastes by modifications to process materials, equipment, and procedures. There is no preferred hierarchy to the source reduction techniques and they may well be used in combination. Techniques for waste recycling should only be pursued once source reduction has been exhausted.

The environmental implications of a new process or product should be considered at the earliest possible stages of a project. The research and development stages therefore provide the most effective opportunity for making fundamental design choices to reduce environmental impact.

Research and development may identify several possible reaction pathways for producing the desired product. All of these pathways should be examined and evaluated in terms of yield, by-product generation, health & safety and environmental impact [USEPA, 1995 #12]. Operators should maintain an audit trail of the design and decision making process so that they can demonstrate what alternative process options were considered and the rationale for the chosen option.

The integration of environmental protection into process design has spawned the terms 'green synthesis' and 'green chemistry'. Green chemistry has been defined as "*the utilisation of a set of principles that reduces or eliminates the use or generation of hazardous substances in the design, manufacture, and application of chemical products*" [Anastas & Warner, 1998 #44]. This definition goes beyond the mere production of chemicals, but producers and regulators may need to consider the broader 'life cycle' of chemicals in order to apply holistic environmental protection. Many important developments are reported in the Royal Society of Chemistry's magazine called 'Green Chemistry' (ISSN 14639262, e-mail: minhash@rsc.org).

The goal of green chemistry is to reduce the inherent hazards associated with products and processes, whilst maintaining the improvements to the quality of life that the industry has brought. It is not a radical new approach since it builds upon factors that have always been part of process design, but it integrates environmental considerations into the heart of decision making. Green Chemistry has been summarised into twelve principles (Table 5.2). These should be incorporated into the design of any new LVOC process, and whenever major modifications of existing processes provide suitable opportunities.

- | |
|---|
| <ol style="list-style-type: none">1. It is better to prevent waste than to treat or clean up waste after it is formed.2. Synthetic methods should be designed to maximise the incorporation of all materials used in the process into the final product.3. Wherever practicable, synthetic methodologies should be designed to use and generate substances that possess little or no toxicity to human health and the environment.4. Chemical products should be designed to preserve efficacy of function while reducing toxicity.5. The use of auxiliary substances (e.g. solvents, separation agents) should be made unnecessary wherever possible and, innocuous when used.6. Energy requirements should be recognised for the environmental and economic impacts and should be minimised. Synthetic methods should be conducted at ambient temperature and pressure.7. A raw material feedstock should be renewable rather than depleting wherever technically and economically practicable.8. Unnecessary derivatisation (<i>use of derivatives</i>) (blocking group, protection/de-protection, temporary modification or physical/chemical processes) should be avoided whenever possible.9. Catalytic reagents (as selective as possible) are superior to <i>un-catalysed</i> reagents.10. Chemical products should be designed so that at the end of their function they do not persist in the environment and (<i>that they</i>) break down into innocuous degradation products.11. Analytical methodologies need to be further developed to allow for real-time, in-process monitoring and control prior to the formation of hazardous substances.12. Substances and the form of a substance used in the chemical process should be chosen so as to minimise the potential for chemical accidents, including releases, explosions, and fires. |
|---|

Table 5.2: Principles of Green Chemistry
[Anastas & Warner, 1998 #44]

5.2.1.1 Product changes

Whilst beyond the immediate scope of IPPC, if the actual product from a process has significant environmental detriment then operators and regulators should be questioning the need for its production and examining the viability of alternatives. If it is possible to produce a more environmentally benign product that fulfils the same purpose, has an equivalent specification and a similar production cost, then the presumption should be for the substitute. Drivers for product changes may come increasingly from customers, banks and insurance companies who require more attention to be paid to the overall Life Cycle of the product.

It may also be possible to reformulate or re-specify the product in order to reduce the quantity of waste arising from its production (e.g. by relaxing the product specification it may be possible to obviate a separation stage). However, there may be strong economic and technical constraints to such changes as they require agreement from customers (who will have their own waste minimisation concerns).

5.2.1.2 Input material changes

The synthesis of an organic compound typically begins with the selection of the starting material and this choice has a significant bearing on the environmental impact of a process. The selection should not only consider the hazardous properties of raw materials and the downstream design implications, but also the environmental impact of how they have been produced. The aim should be to minimise these environmental impacts through substitution with more benign raw materials.

Likewise auxiliary chemical reagents used in a process can pose environmental issues, either directly from their hazardous properties, or indirectly from downstream processing that they necessitate (e.g. separation from the product). Organic solvents are widely used reagents in the production of LVOC and processes should be appraised to determine if the solvent is absolutely necessary (e.g. can water be used as an alternative?). Where the use of an organic solvent cannot be avoided then there should be consideration of replacing it with a solvent of lower volatility and lower environmental impact. After optimisation of these parameters, efforts should then concentrate on reducing the overall use and loss of solvents.

Impurities in raw materials and auxiliary chemicals will introduce unwanted chemical species into a process. These chemicals usually end up as contaminants in the product and this necessitates a separation stage followed by treatment/disposal of the waste stream. This may be avoided by using the highest possible specification for raw materials and auxiliary chemicals and by using reaction inhibitors to prevent the formation of unwanted by-products.

5.2.1.3 Technology changes

Technology changes involve modifications to existing process equipment, or the use of a fundamentally new process to produce the same product. Since technology changes are concerned with process hardware there is often a need for design, expenditure approval and construction that may slow their implementation. New technologies, especially catalytic processes, may also be patented and this may hinder widespread adoption.

Production process changes: Expenditure on raw materials is usually the largest cost in producing LVOC. For commercial reasons, operators therefore aim to maximise the reaction yield and selectivity by applying effective processes that use high performance, selective catalysts and well-designed reactors. This approach typically ensures that environmental emissions are also minimised.

Catalytic reagents are generally superior to un-catalysed reagents on environmental grounds and on process efficiency, although catalysts can themselves create environmental issues. In the design of catalysts it is undesirable to have a low yield per pass of reactants as this necessitates a substantial recycle that is costly and uses power. However, a low conversion per pass often produces a high selectivity, and so there is an economic balance between improved feedstock consumption and energy cost for recycles. The Annex on page 389 provides further practical information on the use of catalysts in the Dutch LVOC industry.

There are often practical obstacles to attaining the yield that is theoretically achievable from reaction kinetics or stoichiometry. The following factors should therefore be considered in deciding the optimal yield:

- energy consumption can increase as the maximum yield is approached and this has associated costs and combustion emissions
- safety considerations may become limiting (e.g. explosion limits)
- in equilibrium reactions secondary products may accumulate and require removal (for example by recycling within the process).

However, it is possible for a reaction to have 100 % yield and yet still generate substantial quantities of waste. For this reason, it is suggested [Anastas & Warner, 1998 #44] that a better measure of reaction economy is 'atom efficiency' (the ratio of the molecular weight of desired product to the molecular weight of all material generated by a reaction). On the basis of atom efficiency, substitution and elimination reactions are undesirable because they generate stoichiometric quantities of unwanted by-products and waste. By contrast, addition reactions show high atom efficiency because they incorporate all the starting materials into the final product.

Biotechnology enables the production of chemicals by means of the synthesising powers of micro-organisms or by using their purified enzymes as biocatalysts. It therefore avoids the use of toxic catalysts and extreme process conditions, although it may produce different waste streams. At present, biotechnology experience is mainly limited to fine chemicals, but it is expected to have increasing application to LVOC.

Changes to equipment, layout or piping: The ultimate aim is for closed processes with no release points to the environment, but this is rarely practicable and the aim is to minimise the number of releases. Operators should aim to reduce equipment-related inefficiencies using such techniques as better seals on pumps to prevent leaks (ingress and egress), and vapour recovery lines to return VOCs to the process.

Additional automation: Additional monitoring and alarm equipment is desirable since it improves the data on process variables and hence enables better process control. Increased automation of process control reduces the likelihood of human error, although this should not be at the expense of operator understanding of process control.

Process Optimisation: There are many process specific changes that can be made to process variables (flow, pressure, temperature, residence time) that optimise production and minimise wastes.

5.2.1.4 Good operating practices

Good operating practices are techniques involving management, organisation or personnel that can be used to minimise waste (i.e. software changes). They can often be implemented very quickly, at little cost, and bring efficiency savings with a high return on investment.

Management practices: Management systems are described in Section 5.1 and they may include employee training, suggestion schemes to encourage waste minimisation, and a clear specification to employees of what good practice actually entails. Although more of an issue for batch processes, production scheduling is also important to minimise the need for vessel opening and cleaning.

Materials handling: Process wastes are often just damaged final products, spill residues or out-of-date / off-specification raw materials. Significant waste reductions can therefore be conferred by inventory control (e.g. reducing the inventory size, increasing turnover, and consolidating chemical use) and material controls (reducing raw material and product loss, and preventing damage during handling / storage).

Waste segregation: Waste streams should be kept separate to reduce the volume of mixed wastes and hence facilitate re-use and treatment

Cost accounting: The full costs of waste treatment and disposal should be allocated to all process activities so that each production unit is aware of the economic implications of waste generation.

Spill and leak prevention: Precautionary modifications should be made to ensure that spills and leaks do not occur, and that they are dealt with promptly when they do arise. The following techniques may be applicable:

- identify all hazardous substances used or produced in a process
- identify all the potential sources / scenarios of spillage and leakage
- assess the risks posed by spills and leaks
- review historical incidents and remedies
- implement hardware (e.g. containment, high level alarms) and software (e.g. inspection and maintenance regimes) to ameliorate the risks
- establish incident response procedures
- provide appropriate clean-up equipment (e.g. adsorbents for mopping up spills after small leaks or maintenance works)
- establish incident reporting procedures (both internally and externally)
- establish systems for promptly investigating all incidents (and near-miss events) to identify the causes and recommend remedial actions
- ensure that agreed remedial actions are implemented promptly
- disseminate incident learning, as appropriate, within the process, site, company or industry to promote future prevention.

5.2.2 Recycling

Where it is not possible to prevent waste arisings through source reduction techniques, then there should be investigation of the opportunities to recycle any wastes, off-specification products and co-products.

Use and re-use: It may be possible to return the waste material back to the originating process as a substitute for an input material. The waste may also be re-used in another process, possibly utilising the waste exchange services that exist in many countries. The potential for re-use of a waste will be determined by its effect on the process; its economic value, and the supply (availability and consistency of composition).

Reclamation: Rather than direct re-use, reclamation involves waste processing to recover the resource value. Reclamation depends on the ability to segregate the desired material from the waste stream. Examples include the recovery of the chlorine content of chlorinated VOCs by incineration and absorption, and solvent cleaning by distillation. The energy value of VOCs can also be reclaimed by their use as fuel.

5.2.3 Waste minimisation initiatives

Most existing production processes have been in operation for many years and may not have benefited from intense environmental scrutiny during their design stage. But existing processes may be able to achieve significant emission reductions using waste minimisation exercises to appraise environmental performance and implement techniques that reduce emissions and improve efficiency. The US Waste Management Assessment Procedure (WMAP) describes a systematic structure for waste minimisation exercises [Kent, 1992 #36] and is summarised below.

Planning and organisation. Waste minimisation exercises should be considered at regular intervals during the life of an installation, and specifically at any time of plant modification. Even production processes that have undergone detailed environmental scrutiny during the design stage should be subjected to waste minimisation exercises, since they will benefit from advances in available technology, environmental legislation and environmental information (e.g. toxicity data). Waste minimisation exercises can only succeed if there is a strong management commitment to provide the necessary momentum and control. Waste minimisation should be evaluated periodically to a defined programme and should set goals by which success can be measured. The project team should be selected to provide a balance of operational experience and technical knowledge. The active participation of operational staff confers ownership of the exercise, and this is important since successful waste minimisation exercises often stimulate further success.

Data gathering. To identify the most important releases, data is required on consumption (of raw materials and energy), re-use (of substances, products and energy) and environmental releases. For all of these parameters it is useful to have information on the location, quantity, quality and cost. The data should adequately reflect all operating modes, any long-term trends, and production rates. Mass balances may be useful in identifying the origin and fate of wastes.

Generation of options. Armed with a detailed understanding of the process and the arisings of wastes, it is possible to identify options for minimisation. This can involve analytical thought processes, creative 'brainstorming', plant inspections and comparison with other similar installations to see what options have already been pursued. The step may involve commercial confidentiality and so the options are not necessarily disclosed outside the company.

Feasibility analysis. The team then evaluates which options are technically and economically feasible, and operationally acceptable. The technical considerations include the logistics of adopting the modification, its effect on product quality and any secondary environmental impacts. The economic evaluation is carried out using standard measures such as payback period or discounted cash flow, and considers both capital and operating costs. The options should be ranked on the basis of profitability to ensure that resources are targeted at emission sources that are the most easily prevented and most important.

Implementation. The chosen options require justification and then funding. The installation of new equipment and the implementation of new procedures may require management commitment to overcome any resistance to change. The effectiveness of completed modifications is evaluated against the expected environmental and economic performance. However, options that have indisputable benefits might be implemented immediately in order to demonstrate a tangible success and to maintain impetus for the initiative. The step may involve commercial confidentiality and so the implementation plans are not necessarily disclosed outside the company.

Future initiatives. Waste minimisation is a concept of continuous improvement and should not be considered as a one-off exercise. A programme should be identified for future initiatives and any particular topics for consideration. Initiatives are typically carried out annually or whenever there are significant changes to the process, product or raw materials. Initiatives may also be appropriate whenever new techniques become available and whenever there are significant environmental incidents.

It has been reported [UK IChemE, 1992 #40] that there can be a number of barriers to waste minimisation and regulators should be aware of these so that installation-specific solutions can be identified. The barriers have been classified as:

- economic (e.g. long pay-back times, shortage of capital, inaccurate accounting for the costs of waste treatment and disposal)
- technical (e.g. lack of information on techniques, concern over impact on product quality)
- regulatory (changes to operating licences, need for environmental assessments)
- cultural (lack of senior management commitment, resistance to change from operators).

5.2.4 Examples of process-integrated measures

As a demonstration of some of the approaches described above, Table 5.3 gives practical examples of techniques that could be applied to new and existing LVOC plants. The table is not exhaustive, but gives potential problems and possible solutions for a number of relevant issues. Although the table mainly involves process-integrated measures, it also includes some 'rethink & redesign' and 'end-of-pipe' solutions.

Potential problem	Possible approach
Process operation & design	
Numerous processing steps create wastes and opportunities for errors	<ul style="list-style-type: none"> Keep it simple. Make sure all operations are entirely necessary.
Non-reactant materials (e.g. solvents, adsorbents) create wastes. Each chemical (including water) employed within the process introduces additional potential waste sources and the composition of generated wastes tends to become more complex.	<ul style="list-style-type: none"> Evaluate unit operations or technologies that do not require the addition of solvents or other non-reactant chemicals.
High conversion with low yields results in wastes	<ul style="list-style-type: none"> Recycle operations generally improve overall use of raw materials and chemicals, thereby increasing the yield of desired products while also reducing the generation of wastes. For example, operating at a lower conversion rate per reaction cycle (by reducing catalyst consumption, temperature or residence time) can result in a higher selectivity to the desired products. The net effect upon recycle of unreacted reagents is an increase in product yield, reduced quantities of spent catalyst and less desirable by-products.
Non-regenerative treatment systems result in increased waste (compared with regenerative systems).	<ul style="list-style-type: none"> Regenerative fixed beds or desiccants (e.g. aluminium oxide, silica, activated carbon, molecular sieves) generate less solid and liquid waste than non-regenerative units (e.g. calcium chloride, activated clay). However the activation and regeneration of beds can cause significant pollutants.
Insufficient R&D into alternative reaction pathways may miss opportunities such as waste reduction or eliminating a hazardous constituent.	<ul style="list-style-type: none"> R&D during process conception and laboratory studies should thoroughly investigate alternatives in process chemistry that affect pollution prevention.
Catalysts	
By-product formation, incomplete conversion and less-than-perfect yield	<ul style="list-style-type: none"> Use a more selective catalyst that will reduce the yield of undesired by-products. Improve reactor mixing/contacting to increase catalyst efficiency Increase activity of the catalyst by means of a higher concentration of active components and/or increased surface area. Develop a thorough understanding of reaction to allow optimisation of the process. Include catalyst consumption and by-product yield.
The presence of heavy metals in catalysts can result in contaminated waste water, waste gases, waste or (by)products	<ul style="list-style-type: none"> Use catalysts comprised of noble metals or non-toxic metals. Both on-site and off-site re-claimers generally recycle catalysts containing noble metals. Use a more robust catalyst or support in case of heterogeneous catalysts
Use of homogenous catalyst may result in entrainment in by-products, waste water, waste gases or wastes	<ul style="list-style-type: none"> Use of heterogeneous catalyst
Emissions or effluents are generated with catalyst activation or regeneration	<ul style="list-style-type: none"> Select off-site catalyst activation or regeneration Use appropriate environmental protection in case of on-site catalyst activation or regeneration
Pyrophoric catalysts need to be kept wet, resulting in liquid contaminated with metals	<ul style="list-style-type: none"> Use of non-pyrophoric catalyst Minimise amount of water required to handle and store safely
Short catalyst life	<ul style="list-style-type: none"> Use catalyst which is less sensitive Avoid conditions which promote thermal or chemical deactivation By extending catalyst life, emissions associated with catalyst handling and regeneration are minimised.
Intermediate products	
Intermediates may contain toxic constituents or have characteristics that are harmful to the environment, under both normal or upset conditions	<ul style="list-style-type: none"> Modify process to reduce amount or change composition of intermediates Use equipment design and process control to reduce emissions

Process temperature	
High heat exchange tube temperatures cause thermal cracking/decomposition of many chemicals. These lower molecular weight by-products are a source of 'light-ends' and leaking losses. High local temperatures give rise to polymerisation of reactive monomers, resulting in 'heavies' or 'tars'. Such materials can foul heat exchangers or plug fixed bed reactors, thereby requiring costly equipment cleaning and production stops.	<ul style="list-style-type: none"> • Select operating temperatures at or near ambient temperature whenever possible • Improve mixing to avoid 'hot spots' • Use lower pressure steam to lower temperatures • Use intermediate exchangers to avoid contact with furnace tubes and walls • Use staged heating to minimise product degradation and unwanted side reactions • Use superheated high pressure steam instead of process furnace • Avoid conditions that foul heat exchangers • Use online tube cleaning technologies to increase heat transfer • Use scraped wall exchangers in viscous service • Use falling film re-boiler, pumped recirculation re-boiler or high-flux tubes.
Higher operating temperatures imply a need for energy input. The energy is usually derived from combustion units that generate emissions	<ul style="list-style-type: none"> • Explore heat integration options (e.g. waste heat or hot process streams to preheat materials and reduce the amount of combustion required) • Use thermo-compressor to upgrade low-pressure steam to avoid the need for additional furnaces and boilers • Cool materials before sending to storage
Water solubility of most chemicals increases with increasing temperature	<ul style="list-style-type: none"> • Use lower temperature (vacuum processing)
Process pressure	
Leaking losses from equipment	<ul style="list-style-type: none"> • Minimise operating pressure. Equipment operating under vacuum is not a source of fugitives; however, leaks into the process require control when system is degassed. • Reduce leaking losses by control measures
Gas solubility increases with higher pressures	<ul style="list-style-type: none"> • Determine whether gases can be recovered, compressed and re-used or require controls
Vapour pressure	
Higher vapour pressures increase leaking losses in material handling and storage.	<ul style="list-style-type: none"> • Use materials with lower vapour pressure.
High vapour pressure with low odour threshold materials can cause nuisance.	<ul style="list-style-type: none"> • Use materials with lower vapour pressure and higher odour threshold.
Corrosive environment	
Material contamination occurs from corrosion products. Equipment failures result from spills, leaks and increased maintenance costs	<ul style="list-style-type: none"> • Avoid corrosivity of materials contacting equipment. • Neutralise corrosivity of materials contacting equipment. This may generate waste. • Improve metallurgy or provide lining or coating of equipment • Use corrosion inhibitors. This may generate waste.
Batch versus continuous operation	
Process inefficiencies and increased emissions of batch processes	<ul style="list-style-type: none"> • Use continuous process where possible • Sequence the addition of reactants and reagents to optimise yields and lower emissions
Vent gas lost during batch fill	<ul style="list-style-type: none"> • Use reactor and storage tank vent balancing lines • Recover vapours (e.g. through condenser, adsorber)
Waste generated by cleaning/purging of process equipment between production batches	<ul style="list-style-type: none"> • Use materials with low viscosity. Minimise equipment roughness. • Optimise product manufacturing sequence to minimise washing operations and cross-contamination of subsequent batches.
Raw materials purity	
Impurities may produce unwanted by-products and waste. Toxic impurities, even in trace amounts, can make a waste hazardous.	<ul style="list-style-type: none"> • Use higher purity raw materials. • Purify materials before use and re-use if practicable • Use inhibitors to prevent side reactions. Note that inhibitors may have environmental impact themselves.
Excessive impurities may require more processing and equipment to meet product specifications, increasing costs and potential for leaking losses, leaks and spills.	<ul style="list-style-type: none"> • Achieve balance between feed purity, processing steps, product quality and waste generation

Specifying a purity greater than needed by the process and the subsequent steps increases costs and can result in more waste generation by the supplier	<ul style="list-style-type: none"> Specify purity no greater than what the process needs.
Impurities/inerts in air as a raw material can increase inert purges	<ul style="list-style-type: none"> Use pure oxygen.
Impurities may poison catalyst prematurely, resulting in increased wastes due to yield loss and more frequent catalyst replacement.	<ul style="list-style-type: none"> Install guard beds to protect catalyst.
Water solubility	
Toxic or non-biodegradable materials that are water-soluble may affect waste water treatment operation, efficiency and costs.	<ul style="list-style-type: none"> Use less toxic or biodegradable materials.
Process water associated with water washing or hydrocarbon/water phase separation will be impacted by solubility of hydrocarbon in water. Appropriate waste water treatment will be impacted.	<ul style="list-style-type: none"> Evaluate alternative separation technologies (coalescers, membranes, distillation etc) Determine optimum process conditions for phase separation. Minimise water usage. Re-use wash water. Evaluate the need for separate treatment of the segregated waste water stream (prior to any further general waste water treatment).
Toxicity	
Community and worker safety and health concerns result from routine and non-routine emissions.	<ul style="list-style-type: none"> Use less toxic materials Reduce exposure through equipment design and process control. Use systems that are passive for emergency containment of toxic releases.
Surges or temporarily increased levels of toxic components can shock or miss biological waste water treatment systems possibly resulting in reduced treatment efficiency and/or release of toxicity in the environment.	<ul style="list-style-type: none"> Use less toxic materials Reduce spills, leaks and upset conditions through equipment and process control. Apply unit pre-treatment to avoid toxics in biological waste water treatment unit. Install buffer capacity for flow and concentration equalisation.
Handling and storage	
Large inventories can lead to spills, inherent safety issues and material expiration.	<ul style="list-style-type: none"> Minimise inventory by just-in-time delivery.
Small containers increase handling frequency which increases changes of material releases and waste residues from shipping containers	<ul style="list-style-type: none"> Use bulk supply, or ship by pipeline. Pack the product in the same containers that the raw materials were supplied in. Use returnable containers or drums
Quantity and quality of waste	
Characteristics and sources of waste are unknown.	<ul style="list-style-type: none"> Document sources, quantities and quality of waste streams prior to pollution prevention assessment
Wastes are generated as part of the process.	<ul style="list-style-type: none"> Determine what changes of process conditions would lower waste generation or toxicity. Determine if wastes can be recycled into the process.
Hazardous or toxic compounds are found in the waste streams.	<ul style="list-style-type: none"> Evaluate which process conditions, routes or reagents (e.g. solvent, catalysts) can be substituted or changed to reduce or eliminate hazardous or toxic compounds.
Environmental fate and waste properties are not known or understood.	<ul style="list-style-type: none"> Evaluate waste characteristics using the following type properties: corrosivity, flammability, reactivity, energy content, biodegradability, aquatic toxicity and bio-accumulation potential of the waste and its degradable products, and whether it is a solid, liquid or gas.
Ability to treat and manage hazardous and toxic wastes unknown or limited.	<ul style="list-style-type: none"> Consider and evaluate all onsite and offsite recycle, re-use, treatment, and disposal options available. Determine availability of facilities to treat or manage wastes generated.
Equipment (compressors, blowers, fans)	
Shaft seal leaks, piston rod seal leaks and vent streams	<ul style="list-style-type: none"> Preventive maintenance programme Seal-less design (diaphragm, hermetic or magnetic) Design for low emissions (internal balancing lines, double inlet, gland eductors) Shaft seal designs (carbon rings, double mechanical seals, buffered seals) Double seal with barrier fluid vented to control device

Concrete pads, floors, sumps	
Leaks to soil and groundwater	<ul style="list-style-type: none"> • Reduce unnecessary purges, transfers and samplings • Use drip pans where necessary • Water stops • Embedded metal planes • Epoxy, or other, impervious sealing
Controls	
Shutdowns and start-ups generate waste and releases	<ul style="list-style-type: none"> • Preferably use continuous processes • Optimise on-line run-time • Optimise shutdown interlock inspection frequency • Identify safety and environment critical instruments and equipment • Improve on-line controls • Use automatic start-up and shut down • On-line vibration analysis • Use 'consensus' systems (e.g. shutdown trip requires 2 out of 3 affirmative responses).
Distillation	
Impurities remain in process stream	<ul style="list-style-type: none"> • Change column operating conditions: (e.g. reflux ratio, feed tray, temperature, pressure). • Clean column to reduce fouling • Insulate to prevent heat loss • Preheat column feed • Increase vapour line size to lower pressure drop • Change the column internals
Large amounts of contaminated water condense from steam stripping	<ul style="list-style-type: none"> • Use re-boilers or inert gas stripping agents • Use higher temperature steam
Storm water and calamity water	
Contaminated rainwater	<ul style="list-style-type: none"> • Segregate storm water from process water sewer. • Provide roof over process facilities • Monitor storm-water release • Roofing certain storage areas can be beneficial, subject to safety constraints
Contaminated sprinkler and fire water	<ul style="list-style-type: none"> • Seal floors • Drain to buffer basin • Route to waste water treatment
Rinsing and cleaning	
Leaks and emissions during cleaning	<ul style="list-style-type: none"> • Design equipment for cleaning • Design for minimum rinsing • Design for minimum sludge • Provide vapour enclosure • Drain to process water system or sump • Use drip pans for maintenance activities • Re-use cleaning solutions
Heat exchangers	
Increased waste due to high localised temperatures	<ul style="list-style-type: none"> • Select operating temperatures at or near ambient temperature whenever possible. • Use intermediate exchangers to avoid contact with furnace tubes and walls. • Use staged-heating to minimise product degradation and unwanted side reactions (e.g. first waste heat, then low-pressure steam, and then high-pressure steam). • Use scraped wall exchangers in viscous service. • Use falling film re-boiler, piped recirculation re-boiler or high flux tubes. • Monitor exchanger fouling to correlate process conditions that increase fouling, avoid conditions which rapidly foul exchangers. • Use on-line tube cleaning techniques to keep tube surfaces clean.
Contaminated materials due to tubes leaking at tube sheets	<ul style="list-style-type: none"> • Use welded tubes or double tube sheets with inert purge. • Operate the least critical medium at a slight overpressure. • Mount vertically. • Steam heating can reduce decomposition and fouling (but may be less efficient than direct firing).
Furnace emissions	<ul style="list-style-type: none"> • Use superheat or high pressure steam instead of furnace.

Piping	
Leaks to soil and groundwater, leaking losses	<ul style="list-style-type: none"> • Design equipment layout to minimise pipe run length. • Eliminate underground piping or design with cathodic protection • Welded fittings. • Reduce number of flanges and valves. • Use all welded pipe. • Use spiral wound gaskets. • Use plugs and double valves for open-end-lines. • Change metallurgy • Use lined pipe • Monitor for corrosion and erosion. • Paint to prevent external corrosion.
Releases when cleaning or purging lines	<ul style="list-style-type: none"> • Use 'pigs' for cleaning. • Slope to low point drain. • Use heat tracing and insulation to prevent freezing and to reduce viscosity, (thus reducing energy demand and product draining losses). • Install equaliser lines. • Flush to product storage tank or treatment facility. • Design pipe networks to avoid dead legs • Frequent drain inspection cleaning programme
Equipment (pumps)	
Leaking losses from shaft seal leaks	<ul style="list-style-type: none"> • Use pressure transfer to eliminate pump. • Mechanical seal instead of packing. • Double mechanical seal with inert barrier fluid vented to control device. • Seal-less pump (canned motor magnetic drive). • Use vertical pump. • Seal installation practices. • Monitor for leaks.
Residual 'heel' of liquid during pump maintenance	<ul style="list-style-type: none"> • Low point drain on pump housing • Flush housing to process sewer for treatment • Increase running time pump by selecting proper sealing materials, good alignment, reduced pipe-induced stress, maintaining seal lubrication.
Injection of seal flush fluid into process stream	<ul style="list-style-type: none"> • Use double mechanical seal with inert barrier fluid where practical.
Reactors	
Poor conversion or performance due to inadequate mixing	<ul style="list-style-type: none"> • Use static mixing • Add baffles • Change impellers • Add ingredients with optimum sequence • Add horsepower • Add distributor • Allow proper reactor head space to enhance vortex effect
Waste by-product formation	<ul style="list-style-type: none"> • Provide separate reactor for converting recycle streams to usable products • Optimise reaction conditions (e.g. temperature, pressure)
Relief valve	
Leaks	<ul style="list-style-type: none"> • Provide upstream rupture disc • Monitor for leaks
Leaking losses	<ul style="list-style-type: none"> • Vent to control or recovery equipment • Monitor for leaking losses (particularly after the valve has discharged) • Monitor for control efficiency
Discharge to environment from overpressure	<ul style="list-style-type: none"> • Vent to control or recovery device • Thermal relieve to tanks • Avoid discharge to roof areas to prevent contamination of rainwater
Frequent relief	<ul style="list-style-type: none"> • Use pilot-operated relief valve • Increase margin between design and operating pressure • Reduce operating pressure • Review system performance
Sampling	
Waste generation due to samples (from disposal, containers, leaks, fugitives)	<ul style="list-style-type: none"> • Reduce number and size of samples needed • Sample at the lowest possible temperature • Cool before sampling • Use in-line in-situ analysers • System for return to process • Closed loop • Drain to sump or process water system

<i>Vacuum systems</i>	
Waste discharges from jets	<ul style="list-style-type: none"> • Substitute by mechanical vacuum pump • Evaluate using process streams for powering jets • Monitor for air leaks • Recycle condensate to process
<i>Valves</i>	
Leaking losses from leaks	<ul style="list-style-type: none"> • Bellow seals • Reduce number where practical • Special packing sets • Stringent adherence to packing procedures
<i>Vents</i>	
Release to environment	<ul style="list-style-type: none"> • Route to control or recovery device • Monitor performance

Table 5.3: Practical examples of process-integrated measures for new and existing LVOC plants
Prepared by [InfoMil, 2000 #83] based on information in [USEPA, 1995 #12]

5.3 Air pollutant control

After full consideration of preventative techniques outlined above, attention can turn to techniques for the control of air pollutants.

The treatment of air emissions normally takes place on-site and usually at the point of generation. Transport of contaminated waste gas streams over longer distances is normally not feasible due to the piping costs and possible problems during transport (e.g. condensation, corrosion, leakage). Waste gas treatment units are specifically designed for a certain waste gas composition and may not provide treatment for all pollutants. The LVOC industry has increasingly reduced the emissions from point sources, and this makes losses from fugitive sources relatively more important.

LVOC processes usually operate with closed process equipment because of reactant/product characteristics (e.g. high volatility, high toxicity, high hazard risk), and reaction conditions (e.g. high temperatures and pressures) and this has associated environmental benefits [InfoMil, 2000 #83]. Special fields of attention with regard to air emission prevention are the raw materials and fuel composition; the required volume of process air; the presence of, and need for, inert gases in the process (e.g. N₂ from ambient air); the energy consumption and the combustion conditions [InfoMil, 2000 #83].

Special attention should be paid to the release of toxic / hazardous components and their impact on the plant surroundings. The LVOC industry is characterised by toxic / hazardous chemicals that are handled and processed in large volumes and so external safety is an important issue.

Emissions from process furnaces, steam boilers and power generating units are directly related to the process energy consumption. Energy savings therefore result in lower emissions from these units.

Dilution of waste gas streams should be avoided at all times, unless required for the proper operation of a technique or the protection of equipment against heat or corrosive components. Dilution generally reduces the efficiency of treatment units and reduces the potential for re-use of the waste gas stream.

Exhaust gases from vents should generally be colourless and free of visible mist, droplets or plume. This reduces nuisance and the entrainment of pollutants in condensing water vapour. The exit temperature of gases can be raised above the dew point by using waste process heat. This may also assist plume dispersion by increasing thermal buoyancy.

The following sections describe the techniques for the prevention and control of generic pollutant groups. The release levels achieved by these techniques are highly dependent on the individual process and local circumstances, but generic performance data may be found in the horizontal BREF on waste water and waste gas. Table 5.4 provides a summary of the key pollutants from the LVOC industry and applicable control techniques.

Pollutant	End-of-pipe technique	Remark
VOC	<ul style="list-style-type: none"> Vapour recovery unit Incinerator Activated carbon filter 	<ul style="list-style-type: none"> Recovers VOC (e.g. condensation, membrane filtration) Destroys VOC (several types e.g. catalytic, auto-thermal) Removes VOC, two types (regenerative, non-regenerative)
NO _x	<ul style="list-style-type: none"> SCR SNCR 	<ul style="list-style-type: none"> Sensitive to catalyst deactivation Requires high temperatures
SO ₂	<ul style="list-style-type: none"> Alkaline scrubber Chemical scrubber 	<ul style="list-style-type: none"> Generates gypsum waste (if lime or limestone is used) Generates waste
H ₂ S	<ul style="list-style-type: none"> Incinerator Incinerator + scrubber Claus-unit Chemical scrubber 	<ul style="list-style-type: none"> Only to reduce odour and toxicity To remove odour, toxicity and sulphur compound Recovers sulphur Recovers sulphur
Particulates	<ul style="list-style-type: none"> Multi-cyclones Fabric filter Electrostatic precipitator Wet scrubber Micro-filtration 	<ul style="list-style-type: none"> Robust but low efficiency for smaller particles Very high efficiency, sensitive to dust characteristics High efficiency, sensitive to explosive mixtures and dust characteristics Efficiency depends on type & pressure, creates waste water Extremely high efficiency, expensive and sensitive
Noxious gases	<ul style="list-style-type: none"> Incinerator Activated carbon 	<ul style="list-style-type: none"> High efficiency, sometimes treatment waste gas necessary High efficiency, may create waste, may allow recovery

Table 5.4: Examples of control techniques to treat air emissions from the LVOC industry
[InfoMil, 2000 #83]

5.3.1 Volatile Organic Compounds (VOCs)

The effectiveness and costs of VOC prevention and control will depend on the VOC species, the VOC concentration, the flow rate, and the source. Resources are typically targeted at high flow, high concentration, process vents, but recognition should be given to the cumulative impact of low concentration diffuse arisings.

There is a presumption [EC, 1999 #30] that toxic VOCs should be replaced by less harmful substances as soon as possible, where this is technically and economically feasible. Where possible, it is also good practice to substitute volatile compounds with compounds that have a lower vapour pressure. Where this is not possible, the initial efforts should be to minimise losses and then to recover the calorific value of unavoidable emissions. The following sections describe some of the prevention and control techniques that are applicable to these arisings.

5.3.1.1 Process vents

Process vents usually represent the largest source of VOCs arisings from LVOC processes. VOCs should, wherever possible, be re-used within the process. The potential for recovery will depend on such factors as:

- **Composition.** In technical and economic terms, a gas stream containing one VOC (or a simple mixture) will be more amenable to re-use than one containing a complex mix. Likewise, high concentration streams (with low levels of inerts) are more amenable to re-use.
- **Restrictions on re-use.** The quality of recovered VOCs should be of a suitable quality for re-use within the process, and should not generate new environmental issues.
- **VOC value.** VOCs that are derived from expensive raw materials will be able to sustain higher recovery costs.

The next best alternative is to recover the calorific content of the carbon by using the VOCs as a fuel. If this is not possible, then there may be a requirement for abatement. The choice of abatement technique is dependent on factors that include the VOC composition (concentration, type and variability) and target emission level. Although costly, there may be need for a combination or selection of techniques, for example [Environment Agency (E&W), 1988 #5]:

1. pre treatment to remove moisture and particulates, followed by
2. concentration of a dilute gas stream, followed by
3. primary removal to reduce high concentrations, followed by
4. polishing to achieve the desired release levels.

Fuller descriptions of abatement techniques are provided in the WWWG horizontal BREF and other texts e.g. [ETBP, 1996 #63]. In general terms, condensation, absorption and adsorption offer opportunities for VOC capture and recovery, whilst oxidation techniques involve VOC destruction. The choice of the best technique will depend on site-specific circumstances, but some of the techniques for consideration are:

- **Condensation.** VOCs can be forced to condense from a gas stream by increasing the pressure or, more usually, reducing the temperature. Condensation can theoretically be applied to any VOC, but the main constraint is the temperature reduction that is necessary to effect the phase change. The choice of heat exchanger depends on the vapour stream characteristics and there may be benefits in using: refrigerated condensers (to remove more volatile species); a series of condensers (to prevent freezing); or scraped heat exchangers (to clear blockages). Indirect cooling systems are preferred as this prevents the formation of effluents. Condensation should receive strong consideration as a primary abatement technique because it enables VOCs to be recovered and re-used. It is a relatively cheap and simple technique that is suited to high inlet concentrations.
- **Absorption.** VOCs can be removed from a gas stream by mass transfer into a scrubbing liquor. The choice of absorbent (e.g. water, caustic, acid) depends on the contaminants, but mineral oil is most widely used for non-polar compounds. The technique is well established and is highly flexible as there are numerous variables that can be manipulated to optimise performance. It is applicable to high VOC concentrations and can achieve up to 99 % removal. The resulting mixture can be treated (often by distillation or degassing) to allow recycling of the absorbent and the contaminants. Thought should be given to using an absorbent that can be re-used directly in the process as this obviates the need for treatment.
- **Adsorption.** VOCs are removed from the gas stream by adhering to the surface of a solid material. Adsorbents are quickly saturated by high concentration flows and so they are typically used as a polishing stage after condensers or scrubbers. Adsorbents require periodic regeneration to maintain their efficiency, and have a limited life after which they require reactivation or disposal. Activated carbon is widely used for the adsorption of VOCs with molecular weights in the range of 45 - 130 and can achieve removal rates of 99 % [Environment Agency (E&W), 1998 #1]. However, it is poor for reactive compounds (such as organic acids, aldehydes, ketones and monomers) and where there is a mixture of low and high boilers. Silica gel, activated alumina and molecular sieve zeolites also have applications.

Thermal Oxidation. The complete thermal breakdown of VOCs will lead to the formation of carbon dioxide and water. This can be combined with existing combustion units (e.g. boilers) or safety systems such as flares (considered in more detail in Annex III: Flare Systems). However, improved control is provided by dedicated abatement units such as high-temperature incinerators, flameless thermal oxidisers, and low-temperature catalytic units (see

- Annex IV: Incinerators for more information). Since oxidation techniques involve VOC destruction, they are only utilised when efforts to recover and re-use VOCs have been exhausted. Oxidation techniques can be used for a wide variety of feed conditions, have good VOC removal efficiencies and introduce the potential for energy recovery. However, there may be issues with the formation of secondary pollutants such as acid gases (from halogenated VOCs), nitrogen oxides and dioxins.
- **Bio-oxidation.** Bio-filtration, bio-scrubbing and bioreactors are relatively new techniques that destroy VOCs using the biological oxidation. Biochemical oxidation is carried out by aerobic micro-organisms that are supported on a substrate. The techniques are suitable for low concentrations of organics and odours. The highest degradation is of aliphatic compounds containing an oxygen molecule and less than seven carbon atoms [Environment Agency (E&W), 1988 #5].

Table 5.5 provides a descriptive overview of the strengths and weaknesses of various VOC control techniques, whilst Figure 5.2 shows the applicability of techniques in terms of VOC concentration and flow. The table and figure should be viewed as initial screening tools in the selection of techniques and are not intended to be prescriptive.

Issue	Recovery and re-use techniques			Destructive techniques		
	Adsorption	Condensation	Absorption	Thermal oxidation	Catalytic oxidation	Biological
Hydrocarbons	D	E	B - D	A	A	A - C
Halogenated or sulphonated organics	D	E	A	B	D	C - E
Aminated organics	D	E	C - D	C	C	B - C
Hydrocarbon condensables ⁽¹⁾	A	A	B - C	A	A	A-C
Halogenated or sulphonated organic condensables	A	A	A - B	B	D	C - E
Aminated organic condensables	A	A	B	C	C	A - C
Continuous flow	A	A	A	A	A	A
Batch or variable flow	A	A	A	D	D	A
Removal efficiency	B	C	A	B	C	A - B
Pressure drop	C	B	B	A	C	A
VOC recovery	B	A	B	E	E	E
Key: A: Excellent B: Good C: Satisfactory D: Poor E: Unacceptable						
1. Condensable hydrocarbons are those which condense at realistically achievable temperatures.						

Table 5.5: Summary of the strengths and weaknesses of VOC control techniques
[Environment Agency (E&W), 1999 #6]

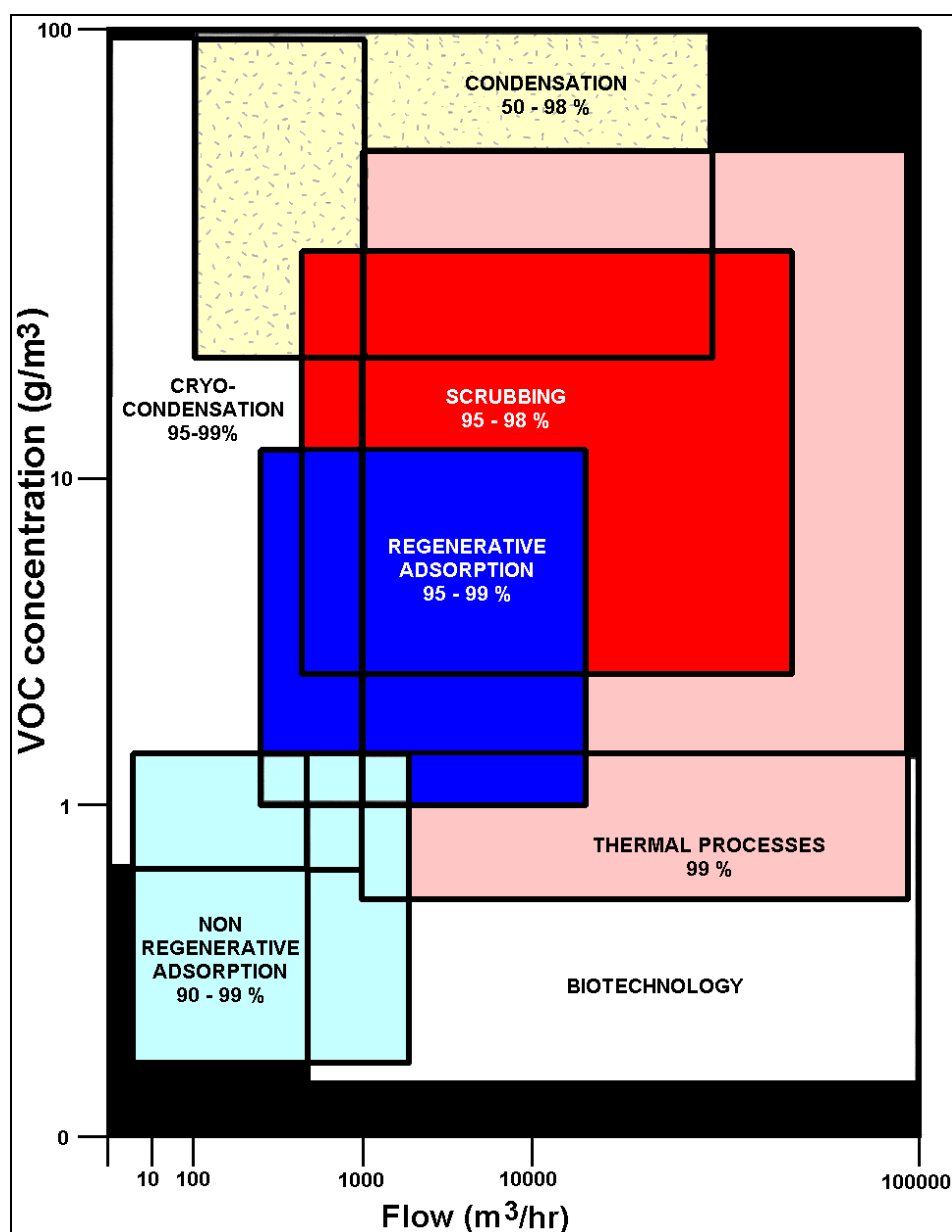

Figure 5.2: Applicability of abatement techniques to VOC flow rate and concentration [Environment Agency (E&W), 1999 #6]

Estimates have been made of the comparative cost of the destruction or recovery of VOCs in continuous vents (Table 5.6).

Abatement technique	Capital cost (£000)	Annualised cost (£000)	Cost per tonne VOC (£/tonne)
Incinerator without energy recuperation	490	456	1170
Incinerator with 70 % energy recuperation	586	238	610
Incinerator with thermal regeneration	720	176	450
Catalytic incineration	630	201	510
Adsorption	1450	315 (a)	800 (a)

Notes (a). No credit included for recovered VOC.

Assumption – 2000 mg/m³ of oxygenated organics in a stream of 25000 m³/hour.

Table 5.6: Cost of incineration or adsorption of VOC [Environment Agency (E&W), 1999 #7] [Environment Agency (E&W), 1998 #1]

However, these costs are highly dependent on site-specific factors (such as plant layout), gas flow-rate and VOC concentration. Table 5.7 shows how the costs of incineration and adsorption increase when the organic loading is low.

Abatement technique	VOC (mg/m ³)	Flow (m ³ /hour)	Annualised cost (£000)
Incinerator with 70 % recuperation - Case A	2000	25000	238
Incinerator with 70 % recuperation - Case B	10000	5000	50
Adsorption – Case A	2000	25000	315
Adsorption – Case B	10000	5000	175

Table 5.7: Costs of incineration or adsorption with sensitivity to process duty
[Environment Agency (E&W), 1999 #7] [Environment Agency (E&W), 1998 #1]

The UK has indicated that the best available techniques can be used on point releases from new processes to achieve the benchmark levels shown in Table 5.8.

VOC Category ⁽¹⁾	Threshold mass flow	Benchmark emission level
Highly harmful	-	See Annex at page 360
Total Class A	> 100 g/h	20 mg/m ³ (as the substance)
	< 100 g/h	As appropriate to process and locality
Total Class B (as toluene)	> 2 kg/h or >5 tonnes/year (whichever is lower)	80 mg/m ³ (as toluene)
	< 2 kg/h or <5 tonnes/year (whichever is lower)	As appropriate to process and locality
(1) As described in Section 4.1.2.1.		

Table 5.8: UK Benchmark levels associated with Best Available Techniques
[Environment Agency (E&W), 1999 #7]

Although LVOC processes are not covered by the scope of the ‘Solvents Directive’ [EC, 1999 #30], the directive nonetheless provides some useful guidance on the prevention and reduction of air pollution from solvent emissions, for example:

- VOCs that are carcinogenic, mutagenic or toxic to reproduction (risk phrases R45, R46, R49, R60, R61) should be replaced by less harmful substances as soon as possible
- where the emission of carcinogenic, mutagenic or toxic VOCs exceeds 10 g/h then an emission limit value of 2 mg/Nm³ should apply
- where the emissions of halogenated VOCs with risk phrase R40 exceeds 100 g/h then an emission limit value of 20 mg/Nm³ should apply

5.3.1.2 Storage, handling and transfer

The general techniques for storage, handling and transfer are dealt with in the horizontal BREF on ‘Emissions from Storage’ [EIPPCB, Draft #49] whilst specific information may be found in the LVOC illustrative process chapters.

At a generic level for LVOC processes, storage tank releases may result from air displacement during ambient temperature changes, during tank filling and from the use of inert gas blankets. The volume held in storage also has an influence and it is good practice to minimise stocks as there is much truth in the adage – “If you don’t store it, you can’t lose it”.

Minimisation techniques are particularly applicable to environmentally hazardous substances, odorous substances and any substances with a true vapour pressure (TVP) in excess of 14 kPa [Environment Agency (E&W), 1999 #7]. Losses from tanks can be minimised by the use of such techniques as [Environment Agency (E&W), 1998 #1] [Finnish Environment Institute, 1999 #55]:

- external floating roof, which can effect a 70 - 90 % reduction in losses
- secondary seals can further improve reductions to 95 %
- fixed roof tanks with internal floating covers and rim seals, which are used for more volatile liquids and can achieve 70 - 85 % reduction
- fixed roof tanks with inert gas blanket
- storage under pressure provides a higher level of containment (e.g. for highly odorous amines)
- inter-connecting storage vessels and mobile containers with balance lines, reducing losses by 75 %.

The temperature of volatile materials held in bulk storage should be as low as possible without causing freezing. Storage temperature can be minimised by passive techniques (such as insulating the tank and painting the tank surface white) and active techniques (such as cooling the tank inlet stream).

All storage tanks should have instrumentation and procedures to prevent overfilling. The instrumentation should include level measurement, independent high-level alarms, high-level cut-off and adequate operating procedures.

Secondary containment may be fitted to tanks after a risk assessment. The capacity of bunds should be 110 % of the largest tank in any bund. Bunds should be impermeable and should be inspected regularly to ensure that they retain their structural integrity. There should be no direct connection of bunds to drains but there should be a draw-off facility for rainwater. Bunds in remote locations should be regularly inspected by operators and fitted with high level alarms.

The loading and unloading of transport containers (rail or road tankers or boats), and the transfer of material between vessels pose a risk of losses to air, ground and water. The techniques available to reduce these risks include:

- tank filling pipes that extend beneath the liquid surface
- bottom loading to avoid splashing
- vapour balance lines that transfer the displaced vapour from the container being filled to the one being emptied
- an enclosed system with extraction to suitable arrestment plant.

When filling transport containers with a loading arm the following are also good practice:

- fit sensing devices to the loading arm to detect undue movement
- use pressure/vacuum sensors to detect accidental spillage and leakage
- install self-sealing hose connections
- fit barriers and interlock systems to prevent damage to equipment from the accidental movement or drive-away of vehicles.

Displaced gases that necessarily occur from storage and handling are preferably recovered by condensation, absorption or adsorption before consideration is given to destruction by combustion (in a flare, incinerator, or energy raising unit). Flame arresters (or other detonation safeguards) will be required in the case of abatement by combustion.

Some estimates have been made of the costs of techniques for controlling evaporative losses from tanks and loading operations (Table 5.9) although the unit costs will vary inversely with vapour pressure.

Abatement technique	Capital cost (£000)	Annualised cost (£)	Cost per tonne VOC (£/tonne)
External floating roof: secondary seal	28	4140	650
Internal floating roof (inside a fixed roof)	79	12300	965
Road tanker modifications	80	11700	835
Single-stage Vapour Recovery Unit	710	137650	2900
Plus second-stage Vapour Recovery Unit(a)	115	22700	9550

Notes. a. Incremental on single stage recovery. Assumptions –Data based on a liquid with a vapour pressure of 40 kPa at operating conditions, storage in two tanks of 5000 m³ each, and transfer of 100000 tpa. Four road tankers are included in this scope. A nominal credit of £150 per tonne is given for saved VOC.

Table 5.9: Cost of VOC containment for storage and transfer
[Environment Agency (E&W), 1998 #1] [Environment Agency (E&W), 1999 #7]

More detailed cost information for a combination of tank types, tank sizes, vapour pressures and control techniques can be found in [Rentz, 1999 #114]. A hierarchy of primary techniques for minimising storage emissions is given in Table 5.10.

	Description of primary measure for minimising storage losses
01	External paint finish of light shade and improved operational procedures (roof hatches not opened unnecessarily, frequent inspections)
02	Conversion of fixed roof to internal floating roof tank. 01 plus installation of internal floating roof with improved primary seal (liquid mounted primary seal or mechanical shoe) & secondary seal (weather shield, rim mounted, mechanical shoe) & roof fitting controlled (pontoon & double deck)
03	01 plus secondary seal (weather shield, rim mounted, mechanical shoe) & roof fitting controlled (pontoon & double deck)
04	01 plus improvement of primary seal (liquid mounted primary seal or mechanical shoe) & roof fitting controlled (pontoon & double deck)
05	01 plus improved primary seal (liquid mounted primary seal or mechanical shoe) plus secondary seal (weather shield, rim mounted, mechanical shoe) & roof fitting controlled (pontoon & double deck)
06	Conversion of external floating roof tank to internal floating roof tank. 01 plus installation of a fixed roof on the outside, internal floating roof with improved primary seal (liquid mounted primary seal or mechanical shoe) & roof fitting controlled (pontoon & double deck)

Table 5.10: Hierarchy of primary measures for minimising storage losses
[Rentz, 1999 #114]

5.3.1.3 Fugitives

Fugitive emissions to the air environment are caused by vapour leaks from pipe systems and from closed equipment as a result of gradual loss of the intended tightness [CEFIC, 2001 #147]. Although the loss rates per individual piece of equipment are usually small, there are so many pieces of equipment on a typical LVOC plant that the total loss of VOCs via fugitive routes may be very significant. For example, fugitive emissions from some Dutch processes account for >80 % of all VOC emissions [InfoMil, 2000 #83]. Leak Detection and Repair (LDAR) programmes are therefore important to identify leak sources and to minimise losses.

5.3.1.3.1 Sources of fugitives and reduction techniques

There are many potential sources of fugitive emissions in LVOC plants but they can be classified into a few common categories, typically; stem packing on valves and control valves, flanges / connections, open ends, safety valves, pump and compressor seals, equipment manholes and sampling points [CEFIC, 2001 #147]. As a very rough guide, it has been estimated that for every pump on an average plant there will be 32 valves, 135 flanges, 1 safety valve and 1.5 open-ended lines [InfoMil, 2000 #83].

- **Valves:** Stem leaks can be caused by such factors as: the use of low quality packing material, inaccurate machining of the stem / packing housing, improper valve assembly, ageing of the packing, inadequate packing compression, and corrosion / abrasion of the packing by dirt. High quality valves have very low fugitive emissions as a result of improved packing systems that are built to stringent tolerances and carefully assembled. In some instances, departing from raising stem valves and using another type of valve can be justified. Good quality quarter turn valves often have lower emissions than raising stem valves and, along with sleeved plug valves, have two independent seals but other considerations may limit their use. Bellows valves have no stem emission at all, but the resulting emission reduction (compared with good quality raising stem valves) may not be sufficient to justify the additional costs. Bellows valves are mainly used for health or safety reasons in highly toxic services (to reduce operator exposure to toxic vapours) or highly corrosive service (to avoid corrosion of the valve components that could lead to a loss of containment). As a very rough guide, bellow valves up to 50 mm will cost four times as much as the same size conventional valve. Valves between 50 and 200 mm will cost three times as much, and valves above 200 mm twice as much as a conventional valve.
- **Control valves:** Because they are frequently opened and closed, control valves are more prone to leakage than shut-off valves. It is not uncommon to find more than 20 % of control valves leaking above 1000 ppm, even in well-maintained plants that have a stringent fugitive emission reduction programme. Using rotating control valves instead of raising stem control valves can help reduce fugitive emissions. Another possibility is to consider process control using variable speed drivers on pumps rather than control valves.
- **Flanges:** On a typical plant, the percentage of leaking flanges is relatively low but due to the large number of flanges they can contribute significantly to total fugitive emissions. Piping systems in cyclic thermal service are likely to have higher leak rates. Leaks from flanges are often caused by misalignment and can be reduced by increased attention to the bolting technique. The flange rating and the gasket material must be adequate for the service. Minimising the number of flanges (by replacement with welded connections) can be considered, compatible with the operations and maintenance requirements of the plant.
- **Open ends:** Most so-called 'open ends' are the vents and drain outlets from pipes, equipment or sampling points. The open ends are fitted with a (normally closed) valve but are prone to very high leak rates if poorly maintained. All vents and drains that are not operated on a regular basis should be blinded, capped or plugged. Those that need to be operated regularly should be fitted with two block valves. Sampling points can be fitted with a ram-type sampling valve or with a needle valve and a block valve to minimise emissions. Losses from sampling systems and analysers can also be reduced by optimising the sampling volume/frequency, minimising the length of sampling lines, fitting enclosures, venting to flare systems and closed loop flush (on liquid sampling points).

- **Safety valves:** Leaks through safety valves discharging to air can be significant. Losses can be reduced by the installation of a rupture disk upstream of the safety valve. Alternatively, safety relief devices and equipment blow-down connections can be connected to a flare or to another vapour abatement system, although this option may be prevented by safety considerations. Balanced bellows-type relief valves are also used to minimise the valve leakage outside of design lift range.
- **Pumps:** Although pump seals can have high leak rates their contribution to the total fugitive emissions is usually relatively small owing to the limited number of pumps installed in a plant. Fugitive emissions can be minimised by the use of high quality and double seal systems. Centrifugal pumps use a double mechanical seal with a seal barrier fluid although this system is quite expensive. In many cases, simpler high performance seal systems can achieve the desired performance regarding fugitive emission. Whenever applicable, seal-less pumps (either magnetically driven or canned) eliminate the fugitive emission completely. Seal-less pumps are not available for all duties and not suitable in services containing particles, particularly iron (which may come from corrosion).
- **Compressors:** Issues with compressors are similar to pumps. However, leak rates from large compressors can be very significant, particularly for positive displacement machines. In addition to the solutions available for pumps, it may also be possible to collect the seal losses and route these to a lower pressure system, if it exists, or to flare.

General factors that apply to all equipment are:

- minimising the number of valves, control valves and flanges will reduce potential leak sources, but this must be consistent with plant safe operability and maintenance needs
- improving the access to potential leaking components will enable effective future maintenance.

In many cases, using better quality equipment can result in significant reductions in fugitive emissions. On new plants, this does not generally increase the investment cost but, on existing plants, replacing existing equipment with equipment of improved quality may be a significant cost (see Section 5.10 for contributory factors). On both new and existing plants, the control of fugitive emissions also relies on LDAR (Leak Detection and Repair) programmes.

5.3.1.3.2 Leak detection

The first step in reducing fugitive emissions is to detect which of the numerous potential leak points on a plant are leaking. The usual detection method is ‘sniffing’ using a hand-held organic vapour analyser (OVA) to measure the vapour concentration at the interface of the potential leak. The best ‘sniffing’ method is generally regarded to be Method 21 as developed by the USEPA. The OVA is either a FID (flame ionisation detector) or a PID (photo ionisation detector), depending on the nature of the vapours. PID techniques can be used in plant areas that have an explosion risk but they are insensitive to many substances. FID techniques are therefore more widely used.

The measured concentration (in ppm) is called the screening value and becomes a ‘leak’ when it exceeds a defined level. The concentration measurements collected by sniffing are not very accurate because measurement and interpretation are influenced by factors, such as:

- OVA type and manufacturer - the measured concentration is influenced by the pumping rate and by the size and shape of the probe tip.
- Operator skill - the speed at which the probe tip is moved and the distance to the leak point interface have an influence. Good practice is described in USEPA Method 21.
- Weather conditions during measurements - measurements undertaken in high winds are useless. The intensity of precipitation and the ambient may also play a role.

- Background concentration - an average background concentration can be measured and deducted from measurements but this does not take account of the background variability.
- Nature of the emitted vapour - the response factor of the instrument to the substances being emitted must be taken into account. However, the exact composition of the vapours is often not precisely defined for every potential leak point.
- OVA calibration – the detector must be re-calibrated on a regular basis to avoid drift.
- Pressure in the system - appendages at elevated pressure have a higher tendency for leaking than appendages in service at atmospheric pressure, but the use of better construction standards reduces this tendency.
- Substances present in the equipment - the information on the substances is important for classification purposes (gaseous, low boiling, high boiling) so that the emission load can be calculated (e.g. using the EPA correlation method).

Developments in leak detection methods can be expected in the future but there are alternative methods that are already used or under development; namely:

- Use of dogs - trained dogs can detect emissions at low ppm values but this is restricted to non-toxic substances at a temperature below 60 °C. Once detected, leaks are quantified by ‘sniffing’ (as described above).
- Infrared laser based visualisation device - this promising leak detection method is under development by the American Petroleum Institute. The aim is to develop a portable device that allows visualisation of the leaks in the device’s viewer.

Some leak sources that have a very low risk of causing fugitive emissions are not covered by leak detection programme. For example, sniffing is not an appropriate method for leak detection from systems that only contain heavy liquids with a vapour pressure below 0.3 kPa at 20°C. These leaks can anyway be detected visually and the losses do not contribute significantly to overall fugitive emissions.

5.3.1.3.3 Leak repair

Leak detection is carried out so repairs can be effected and fugitive emissions reduced. If the repairs are not completed or are ineffective, then no emission reduction is achieved. Repairs should therefore be carried out as soon as possible after leak detection and a staged repair approach is often applied to reduce the costs:

- Immediate, minor repairs can be performed while the equipment is still operating by, for example, tightening bolts to eliminate leaks from valve stems or flanges, or installing / tightening caps on open ends. This is often effective for open ends and flanges but not always so for valve stem packing as over-tightening may prevent valve operation or may completely destroy the packing thus causing a larger leak. In any case, bolt tightening on equipment under pressure needs to be executed carefully by skilled operators and may not always be appropriate due to safety reasons (e.g. high pressure).
- Leaks that cannot be stopped by immediate minor repair are considered for more intensive repair. As this can involve changing a gasket or valve packing it typically requires the equipment to be taken out of service. Repairs to equipment that is continuously in service are usually delayed until the next plant shut-down or turnaround.
- When no effective repair can be performed, replacement of the equipment needs to be considered.

The threshold leak rate at which repairs are performed depends on the plant situation and the type of repair required. Minor repairs are low cost interventions and can be performed on all leaks above a low threshold (CEFIC quote a figure of 1000 ppm). Setting the threshold for repair at a low level reduces the number of leaks that evolve into bigger leaks (requiring more difficult and expensive repair). However, performing intensive repairs at the same low

threshold is not justifiable and the leak threshold value is set higher - CEFIC quote a figure of at least 10000 ppm [CEFIC, 2001 #147].

In the Netherlands the threshold levels for leak repair are more stringent and also distinguish between carcinogenic and non-carcinogenic substances. The service area of DCMR (Rijnmond-Rotterdam Harbour) has the following approach (source Infomil e-mail to EIPPCB of 17/07/01):

“At measured concentrations higher than 1000 ppmv (leaking threshold), direct action will be taken to repair the leak. After the leak has been repaired, the point is measured again. If the leaking persists (> 1000 ppm), the leak is again repaired.

In the case of carcinogenic substances a leaking threshold of 500 ppm is respected.

When concentrations are measured between 500 and 1000 ppm, the equipment may only be used for non-carcinogenic substances.

The mentioned concentrations are corrected for the response factor of the measuring equipment to the relevant substance.”

5.3.1.3.4 Emission quantification

In general terms, the level of fugitive emissions will depend on such factors as:

- the vapour pressure of the substance being handled
- the number and type of sources
- the method of determination (estimation or monitoring)
- the inspection and maintenance regime for sources, and
- to a lesser extent, the rate of production.

There are several established techniques for the quantification of fugitive losses from a plant and further detail may be found in the Monitoring BREF [EIPPCB, Draft #51]. Most techniques first require an accurate component count and the establishment of a database. This can be carried out using unit flow plans, by field inspection or a combination of both. In making the component count, all process pipework is normally considered, but small diameter instrument connections are not (since these include a large number of very small valves with relatively low potential leak rate). Components are classified in terms of type, service and process conditions to identify those elements with the highest potential for fugitive loss and to facilitate the application of industry standard leak factors (for example those of the USEPA in Table 5.11). An estimate of overall fugitive emissions from the plant can be derived but experience shows that this can give an over-estimation of fugitive losses [CEFIC, 2000 #111].

Equipment type	Service	Emission factor (g/h/source)
Valves	gas	5.97
	light liquid	4.03
	heavy liquid	0.23
Pump seals	light liquid	19.9
	heavy liquid	8.62
Compressor seals	gas	228
Pressure relief valves	gas	104
Connectors	all	1.83
Open-ended lines	all	1.7
Sampling connections	all	15.0
NB: Different emission factors are specified for different leak rates		

Table 5.11: Average USEPA emission factors
[InfoMil, 2000 #83]

A more accurate emission quantification typically involves deducing a leak rate (kg/year) from the screening value for each point, adding the leak rates of all leak sources and integrating over the reporting time period (typically one year). At each stage, uncertainties creep into the calculation and so the quantification of fugitive emissions is fairly inaccurate, even if it is based on the results of an extensive sniffing campaign.

Estimations of emission levels may be validated by gas imaging [European Sealing Association, 2001 #155], dispersion modelling (to predict atmospheric mass flux and concentrations) and environmental monitoring techniques (to compare the predicted and measured situations). More detail on these methods may be found in the Monitoring BREF [EIPPCB, Draft #51].

5.3.1.3.5 Targeted monitoring

Since leak detection is a labour intensive and expensive activity it is important to develop a methodology that minimises the work whilst maximising the reductions in fugitive emissions. Monitoring programmes for sniffing consider and adjust the following parameters to define the most suitable programme:

- the monitoring frequency: at what time interval should potential leak points be screened for leaks?
- the percentage of the hardware that needs to be monitored: sampling can help reduce costs while providing reliable indications on the trend in emissions from the related components
- the type of hardware that needs to be monitored: what are the limits in size, service or type of hardware beyond which screening for leaks is not beneficial?

‘Targeted Monitoring’ defines a programme that directs the main effort at the leak points with the highest rate of leakage. It involves the following steps:

- Make a survey of all potential leak points on the plant. Ideally, a complete plant survey should be carried out using up-to-date piping and instrumentation drawings to establish population counts of equipment and fittings. The survey should cover gas, vapour and light liquid duties. In large plants the survey costs force a staged approach, either by dividing the plant into units or by first screening only valves / rotating equipment followed later by the screening of flanges. Alternatively, sampling can be used on items on which low leak rates are expected (e.g. flanges) to assess their rate of leakage.
- Analyse the results of the first screening survey. There are always large differences in the leak rates of components and it is often impossible to predict which components will leak most. This analysis is best performed with the aid of a database that records relevant data on each potential leak point. The potential leak points can be divided into families (e.g. by type of component, size, service) and the percentage of elements leaking above a defined threshold (e.g. 1000 ppm) can be defined for each family.
- Focus further monitoring and repair on those families with the highest percentage of leaking elements. This maximises the reduction in fugitive emissions per unit of expenditure. Sometimes it may be expensive to repair items with high leak percentages and the contribution of these items to the total fugitive emission must be considered. If the family contribution to the total emission is low (i.e. few items in the family), then expensive repair may be less justified than to other items contributing more to the total (but with a smaller percentage of leaking elements).
- Define whether high leak percentages are caused by structural causes (e.g. inadequate gasket material, wrong type of valve) and define corrective action accordingly.
- As effective repairs are carried out on the components having the highest focus, shift the priority to new families of components that rise to the top of the list.
- Use a sampling strategy to check that families of components having a low percentage leaking components remain at this level.

This approach has several advantages:

- it maximises the reduction in fugitive emissions and minimises the cost
- it defines improvements that are required in the specification of plant components
- it identifies improvements to the repair methods
- it means that a significant percentage of all potential leak points do not need to be screened on an annual basis. Emission calculations are therefore based on a partial set of screening values and on average emission rates from previous surveys for the remaining points.

There are differing views on the guideline frequency for measuring leaks. CEFIC state that “every four years seems a reasonable frequency” whilst a Member State considers that “all leak sources should normally be measured once a year”. It is generally agreed, however, that the exact programme for leak measurement will depend on the results from the initial (baseline) measuring exercise and the feedback from subsequent LDAR activity.

A variety of management systems may also be needed to support the a LDAR programme, for example:

- physical labelling of sources with a unique reference number
- up-to-date maintenance of process and instrumentation diagrams (P&IDs) showing the sources
- a database of sources (with reference number, equipment manufacturer, gasket material, etc.), programmed detection survey dates, leak detection results, completed repair work and planned repair work.

5.3.1.3.6 Costs

Estimates have been made of the costs of preventing fugitive emissions but for techniques such as the installation of high-integrity equipment and fittings, it is difficult to split out the true incremental costs. A simple LDAR scheme, involving the annual inspection of gas and volatile liquid service components, is estimated to have a net annualised cost of £12000 per year or £760 per tonne of VOC (for a typical plant handling 20000 tpa of gaseous hydrocarbon streams and 30000 tpa of volatile liquids) [Environment Agency (E&W), 1998 #1].

5.3.1.3.7 Diffuse and other fugitives sources

The term fugitive emissions can also apply to emissions that arise from process operations (e.g. opening of vessels, filtering, stirring / agitator seals) and due to volatilisation from liquid spills, effluent collection systems and effluent treatment plants. These fugitive emissions are measured and controlled using different techniques to those described for piping and equipment leaks. Relevant operational and maintenance techniques may include:

- reverse the pressure gradient by operating the plant at below ambient pressure (this is probably most feasible at the design stage)
- obviate the need for vessel opening through design modifications (e.g. cleaning sprays) or change the mode of operation (e.g. spray anti-caking reagents directly into vessels)
- convey leaks from compressor seals, vent and purge lines to flares or to flame-less oxidisers (the UK reports the use of Thermatrix units)
- enclose effluent collection systems and tanks used for effluent storage / treatment to reduce evaporative losses (as long as this does not compromise system safety)
- monitor cooling water for contamination with organics (e.g. from heat exchangers).

5.3.1.3.8 Further information

Further details on fugitives can be found in Annex II: Leaking Losses. This study concluded that:

- as a result of the efforts to reduce point sources, leaking losses form a significant part of the total emissions from the LVOC industry
- leaking losses are hard to determine and a monitoring programme is a good starting point to gain insight into the emissions and the causes. This can be the basis of the action plan
- the successful abatement of leaking losses depends heavily on both technical improvements and the managerial aspects
- motivation of personnel appears to be an important factor in the overall emission abatement of leaking losses
- abatement programmes can reduce the unabated losses (as calculated by average US-EPA emission factors) by 80 - 95 %
- special attention should be paid to long term achievements
- most reported fugitive emissions are calculated rather than monitored and not all calculation formats are comparable. Monitoring at well-maintained Dutch plants shows that the average emissions factors are generally higher than measured values
- abatement of fugitive emissions is less process related than process emissions.

5.3.1.4 Intermittent Vents

Significant VOC releases can occur from intermittent activities such as pressure relief, blow-down and process start-up / shutdown. A number of techniques can be used to reduce these arisings:

- minimise inventories prior to shutdown
- establish start-up and shutdown procedures that minimise purges to relief and blow-down
- discharge any vessel contents to enclosed receptors (blow-down drums)
- pass vents to a flare or the site boiler (e.g. streams created by purging and steam cleaning of equipment, handling catalyst and disposing of waste)
- install two tiers of pressure relief – one at a low trigger pressure allowing low flows to pass to abatement, and another at a higher trigger pressure to deal with low probability, high flow events.

5.3.2 Combustion gases

In terms of pollutants from combustion units, the main emissions are of carbon dioxide, nitrogen dioxide, sulphur dioxide and particulates:

- **Carbon dioxide** emissions can be reduced by switching to low-carbon fuels or to non-fossil fuels. Switching to low-carbon (hydrogen-rich) fuels is usually not cost-effective if only the CO₂ benefits are calculated. However, such fuels normally also have lower sulphur and ash content and if the benefits of reduced SO_x and dust emissions are also included, the fuel switch can be very cost-effective [InfoMil, 2000 #83].
- **Nitrogen dioxide** emissions from combustion are most commonly reduced by combustion modifications that reduce temperatures and hence the formation of thermal NO_x. The techniques include low NO_x burners (up to 70 % NO_x reduction), flue gas recirculation, and reduced pre-heat. Nitrogen oxides can also be removed after they have formed by reduction to nitrogen. Selective Non Catalytic Reduction (SNCR) uses the injection of ammonia or urea and achieves removal rates of 60 - 80 % [Environment Agency (E&W), 1998 #1]. Selective Catalytic Reduction (SCR) injects ammonia into a catalyst bed and can achieve up to 95 % reduction [Environment Agency (E&W), 1998 #1]. The incremental cost on new plant is small although costs become more significant the smaller the plant and the overall viability probably depends on local environmental impact. Estimated costs for a retrofit on an existing plant are shown in Table 5.12. Emissions can be limited to <30 mg NO_x/MJ by burning gas with low NO_x technology [SEPA, 2000 #75].

Abatement technique	Capital cost (£000)	Annualised cost (£)	Cost per tonne NOx (£/tonne)
Low NOx Burners	190	38	1200
Selective Non-Catalytic Reduction (SNCR) ⁽¹⁾	540	171	3600
Selective Catalytic Reduction (SCR) ⁽¹⁾	1865	417	6950
Note 1: based on the flue gas from a 40 MW fired heater			

Table 5.12: Cost of Nitrogen Oxide abatement
[Environment Agency (E&W), 1998 #1] [Environment Agency (E&W), 1999 #7]

- **Sulphur dioxide** emissions are usually low but can be reduced by switching to lower sulphur fuel oil or to natural gas. This has been estimated [Environment Agency (E&W), 1999 #7] to cost around £300 to £500 per tonne of sulphur dioxide (excluding any costs of converting burners). Reductions can also be achieved by the in-furnace injection of alkali or by flue gas treatment.
- **Particulate** emissions can be reduced by the optimisation of combustion conditions or switching to natural gas. Unavoidable arisings can be captured in bag filters or electrostatic precipitators.

In general terms, LVOC processes may generate these combustion gases from process furnaces, steam boilers and gas turbines:

1. **Process furnaces.** Gas fired furnaces with low-NOx burner configuration can achieve NOx reduction down to 50 - 100 mg/Nm³ for new and existing installations. Values towards the higher part of the range indicate the adverse effect of high temperatures (air preheat) and hydrogen-rich fuels. In exceptional situations, with little possibilities for retrofit, emissions may be up to 200 mg/Nm³.
2. **Steam boilers:** Using gas firing, low-NOx burners and flue gas recirculation can achieve NOx emissions of 35 mg/Nm³ in new boilers and 100 mg/Nm³ in existing boilers. When firing gas, emissions of dust and SOx are negligible.
3. **Gas turbines:** Dry low-NOx combustors (natural gas) in new gas turbines can achieve a NOx level of 50 mg/Nm³ (at an oxygen content of 15 vol%) with negligible emissions of dust and SOx. Steam injection or SCR in existing gas turbines is also used, although the cost-effectiveness of SCR should be taken into account. Steam injection is primarily used with oil fuels for which dry low NOx combustors are less effective. A NOx level of 75 - 100 mg/Nm³ can be attained with steam injection. The application of SCR can reduce NOx by up to 95 % (18 mg/Nm³). Emissions of dust and SOx are negligible.

Since they are usually based on standard designs, more detailed information on steam boilers and gas turbines may be found in the BREF on Large Combustion Plants [EIPPCB, Draft #127].

5.3.3 Particulate matter

There are not usually many arisings of particulate matter from LVOC processes but, where there are, the following prevention techniques have been shown to be beneficial.

- dust-prone materials should be contained in silos, storage tanks or covered areas and served by dust-suppression equipment (e.g. water sprays)
- fit flexible seals to vessel charging manholes
- enclose handling facilities in a building
- provide handling areas with local vacuum extraction that is connected to dust abatement.

Where these source controls cannot prevent occurrence, then a number of techniques can be used for abatement, namely:

- **Cyclones.** Centrifugal force is employed to separate particles down to 5 to 10 μm . They are robust and are widely used for high temperature and pressure operation.
- **Filters.** Fabric or ceramic mediums are used to impinge particles. They provide higher removal efficiency than cyclones and may be further enhanced by the use of pre-coating.
- **Wet collection devices.** Particles are wetted and removed from the gas stream in venturi, jet or dynamic scrubbers. They are suitable for high-temperature and high-moisture gases.
- **Electrostatic precipitators.** These can be of the wet or dry type, but they have limited application in organic chemical processes because of the explosion and fire risks that they pose to flammable gases.

5.3.4 Performance of air pollutant control techniques

When the combination of generic techniques described in Section 5.3 are applied to LVOC processes they have been able to achieve the emission ranges shown in Table 5.13. In general terms, the stated emission ranges would be achievable by the thermal combustion of polluted gaseous streams (sometimes with subsequent flue gas treatment) and the use of sulphur-free fuel gas to assist combustion. In some cases, the performances are not achievable by catalytic combustion but only by high temperature thermal oxidation.

Sub sector	NOx mg/m ³	SO ₂ mg/m ³	CO mg/m ³	Total C mg/m ³	Dust mg/m ³	PCDD/F ng/m ³	Specific compounds (mg/m ³)
Aromatics	115 - 300	3	4 - 50	6	3		
Olefins	80 - 200	5 - 35	10 - 180	10 (5 - 150) *			Butadiene 1 mg/m ³
Halogenated compounds	30 - 200	-	5 - 50	4 - 35		0.07- 0.05	Inorganic Comp. 4 – 8 mg/m ³ HCl 10 mg/m ³ Chlorine 1 - 5 mg/m ³ Vinyl chloride < 1 mg/m ³ 1,2 – Dichloroethane < 1 mg/m ³ Ethylene chloride < 5 mg/m ³
Oxygenated compounds	100 - 300	< 2 - 6 SO ₂ / SO ₃	< 5 - 100	3 - 100	1		Formaldehyde 0.2 – 0.4 mg/m ³ Acetic acid 1 - 22 mg/m ³ Acetaldehyde 6 - 20 mg/m ³ Ethylene oxide 0.5 – 5 mg/m ³ Propylene oxide 0.1 – 5** mg/m ³ Ethylene glycol 30 – 100 mg/m ³
Nitrogenated compounds	12 - 200	<20	< 2 - 130	< 1 - 35	< 1 - 5		Caprolactam 100 mg/m ³ HCN 1 - 3 mg/m ³ Nitrotoluene 0.7 mg/m ³ Toluenediamine (TDA) 0.6 mg/m ³ Toluene diisocyanate (TDI) 4 mg/m ³

Note: NOx, SO₂, CO, Total C, and dust measured as ½ hour averages. PCDD/F as single measurement
Note: * after treatment by flare. ** after treatment by gas scrubber / cooling tower.

Table 5.13: Emission levels associated with BAT [UBA (Germany), 2000 #91]

5.3.5 Monitoring of air emissions

General information on the monitoring of air emissions may be found in the horizontal BREF on Monitoring [EIPPCB, Draft #51].

5.4 Water pollutant control

The techniques that can be applied to new plants and to existing facilities will differ. In existing plants, the choice of control techniques is usually restricted to process-integrated (in-plant) control measures, in-plant treatment of segregated individual streams and end-of-pipe treatment. New plants provide better opportunities to improve environmental performance through the use of alternative technologies to prevent waste water arisings.

An appropriate control strategy for waste water from the LVOC industry can be summarised as [InfoMil, 2000 #83]:

- organic waste water streams not containing heavy metals or toxic or non-biodegradable organic compounds are potentially fit for combined biological waste water treatment (subject to an evaluation of biodegradability, inhibitory effects, sludge deterioration effects, volatility and residual pollutant levels in the effluent)
- waste water streams containing heavy metals or toxic or non-biodegradable organic compounds (e.g. indicated by high AOX /EOX or high COD/BOD ratios) are preferably treated or recovered separately. Individual waste streams containing toxic or inhibitory organic compounds or having low bio-degradability are treated separately e.g. by (chemical) oxidation, adsorption, filtration, extraction, (steam) stripping, hydrolysis (to improve bio-degradability) or anaerobic pre-treatment. Some specific examples of waste water streams from LVOC processes are: heavy metals (e.g. copper from adipic acid or HMD-production), inhibitory organic compounds (e.g. alkali water from aniline-production) and low degradability (e.g. cyclohexanone/ol, caprolactam-production).

The Annex on page 386 provides an interesting historical review of the waste water treatment strategies adopted by two Dutch LVOC sites. These case studies emphasise the dual importance of technical measures and management systems, and the need to fully exploit process-integrated techniques before constructing expensive end-of-pipe waste water treatment plants.

5.4.1 General prevention techniques

Before considering waste water treatment techniques, it is first necessary to fully exploit all the opportunities for preventing, minimising and reusing waste water. However, water use, effluent generation and effluent treatment are all intrinsically linked and should be considered in combination. A typical exercise in preventing waste water may include the following steps:

Step 1: Identify waste waters - The first step is to identify all waste water arisings from a process and to characterise their quality, quantity and variability. Pareto analysis is useful to identify those sources that use most water and contribute most waste water. Further clarification is provided by the preparation of plans that show all drain networks, points of arising, isolation valves, manholes and points of discharge.

Step 2: Minimise water flows - The overall aim is to minimise the use of water in the process in order to obviate effluent production or, if that is not possible, to produce more concentrated effluents. It will be necessary to identify the minimum quantity of water that is needed (or produced) by each step of the production process and then to ensure that these requirements are implemented by such practices as:

- use of water-free techniques for vacuum generation (e.g. use the product as a sealing liquid in vacuum pumps, use dry pumps)
- change cleaning procedures to use counter-current (rather than co-current) washing and water sprays (rather than jets)
- employ closed loop cooling water cycles
- roof the installation to minimise storm-water ingress
- use management tools such as water-use targets and more transparent costing of water

- install water meters within the process to identify areas of high use
- use dry cleaning techniques wherever possible.

Step 3: Minimise contamination - Waste waters are created by contamination of process water with raw material, product or wastes; either as part of process operation, or unintentionally. The following techniques can prevent this contamination:

Process operation:

- use indirect cooling systems to condense or cool steam phases (not direct injection systems)
- use purer raw materials and auxiliary reagents (i.e. without contaminants)
- use non-toxic or lower toxicity cooling water additives (e.g. chromium based additives).

From spills:

- construct impermeable bunds around tanks with 110 % capacity of the largest tank
- fit secondary containment to vessels and pipe-work that pose a high risk of leaks
- store drums on concrete hardstanding that drains to a holding sump)
- provide spill clean-up material (adsorbents, booms, drain plugs etc.) at strategic points around the installation and prepare spill contingency plans
- use dry clean-up methods (e.g. vacuum) rather than creating effluents using water
- carry out regular checks for leaks and have systems for prompt repair
- use separate collection systems for process effluent, sewage and rainwater (although there may be cases where the blending of effluent streams offers treatment advantages)
- provide containment areas for fire-fighting water so that it can be isolated from other drainage systems and treated as necessary
- provide concrete hardstanding in loading/unloading areas with kerbs / ‘sleeping policemen’ (low-level humps in a road for the calming of traffic) that drain to a sump.

Step 4: Maximise waste water re-use - Even when waste waters are created they do not necessarily have to be sent to a treatment plant. To identify options for re-use it is first necessary to define the lowest water quality that can be used for each activity in the process. A widely used methodology for water conservation and waste water minimisation is Pinch analysisTM. When used on petrochemical processes, this method identified ‘easy’ water savings of up to 25 % using simple pipe and control changes, and savings of more than 50 % with process modifications [Linhoff, 1998 #38]. The method plots the purity and flow for all sources and sinks for fresh water and waste water. The resulting ‘purity profiles’ identify the scope for water re-use and the affordability of these options can then be assessed.

Waste water re-use may be achieved by refining and reusing (rather than disposing of) mother liquors; reusing waste water in the process (e.g. for raw material make-up) and reusing waste water for other purposes (e.g. equipment cleaning).

The potential for re-use can be facilitated by the provision of storage tanks so that waste water production and the demand for re-use can be synchronised. The potential is further improved by collecting water-insoluble materials (e.g. oil, light organics, heavy organics, suspended solids) from the water phase by installing appropriate separators close to the point of origin.

Step 5: Maximise recovery/ retention of substances from mother liquors unfit for re-use. Substance retention can be achieved by prevention, such as modification of reaction parameters, as well as additional measures, especially improvement of mother liquor work-up. The retention can be achieved by removing substances (e.g. by adsorption, extraction) or by conversion of substances (e.g. by oxidation). Measures for recovering waste water constituents can generally only be carried out with concentrated streams (mother liquors) for a reasonable expenditure. Recovery measures can be justified in the case of contents of several percent - even at lower concentrations with substances which can be removed readily (volatile, solid, precipitable or extractable substances).

Groundwater is an integral part of the aqueous environment and many of the general measures for the protection of surface water will be applicable to groundwater. However, the remediation of groundwater pollution is notoriously difficult and there should be an even stronger emphasis on the prevention of contamination. The risk of process leaks should be evaluated in the context of the local hydrogeology and additional measures should be considered in order to prevent the contamination of soil and groundwater. These may include [Finnish Environment Institute, 1999 #55]:

- install leak detection systems (especially on underground tanks)
- install overflow detection systems (e.g. high-high level alarms and automatic cut-off)
- replace any permeable ground in the process area (including loading/unloading areas) with impermeable concrete or asphalt (note that solvents may still be able to pass through asphalt)
- avoid drains that discharge to ground (e.g. storm-water, fire-water)
- waterproofing of vessels
- install collection facilities where leaks may occur (e.g. drip trays, catch pits)
- ensure that maintenance procedures require equipment to be fully drained prior to opening
- pay special attention to the connection and disconnection of tankers
- beware of potential contamination by dust emissions
- ensure that there is a programme of inspection and maintenance for all vessels (especially underground tanks) and drains
- for particularly high risk scenarios, consider the use of above-ground, pumped drains
- monitor the quality of groundwater in order to identify any changes in quality.

5.4.2 Abatement techniques

Most waste water components of LVOC processes are biodegradable. The corresponding waste water streams can be treated biologically where needed, commonly at centralised treatment plants, or in separate plants. In both cases segregation is recommended to separate the non-biodegradable waste water streams and the low or uncontaminated waste water streams, that may unnecessarily dilute the waste water streams targeted for biological treatment.

Other LVOC sites rely on separate treatment of segregated streams from individual process units, and this allows treatment to be tailored to specific components of the effluent. This guarantees a high removal efficiency of the unwanted compounds, but it generally costs more and treatment units are more sensitive to process fluctuations and disturbances.

The amenability of waste water to treatment can also be improved by such techniques as:

- use flow balancing to equalise flow and load inputs to a treatment plant
- fit catch-pits on waste water collection networks to capture spills and prevent catastrophic impact on waste water treatment plants
- avoid hydraulic overloading of plants by installing a separate drainage system for storm water, or diversion systems to direct only the 'first flush' of rainwater (carrying contamination from roofs, roads and paved areas) to the waste water treatment facility
- pre-treat effluents to remove components (e.g. oil, toxics, volatiles, metals) that may hinder biological treatment.

Although waste water treatment systems reduce the emissions to water, they may cause their own environmental emissions. Volatile organic and inorganic compounds will pass from effluents whenever they are in contact with the atmosphere. Arisings may occur from the aeration of biological waste water treatment basins, stirring operations, open buffer tanks, settling tanks, the mixing of water flows with different temperatures or the addition of acids or caustic for pH-adjustment. Other potential cross-media emissions are given in Table 5.14.

Medium	Potential effect/emission	Possible control techniques
Air	Evaporation/formation of odour (e.g. H ₂ S, NH ₃ , mercaptans etc.). VOC emissions (evaporating from the water).	Closed systems.
Water	In principle significant reduction of water emission. May be an extra source of emissions if storm-water is treated together with process water and treatment system gets overloaded.	Segregate storm-water from process effluents.
Waste	Waste water treatment sludge	Extended residence times to promote endogenous respiration.
Other	WWT plants consume energy. Bio-gas may be generated and used as an energy source.	

Table 5.14: Cross-media emissions from waste water treatment plants
[InfoMil, 2000 #83]

The selection of the appropriate treatment technologies requires detailed consideration of the physical and chemical nature of all the waste waters. Attention should initially focus on the identification and evaluation of treatment opportunities for segregated effluents, and only when these have been exhausted should there be consideration of whole plant treatment for combined streams. The combination of segregated in-plant treatment and combined end-of-pipe treatment measures will be based on such factors as:

- removal efficiency of, for example, organic content (BOD, COD), AOX, EOX, toxic organic compounds, metals and nutrients (N, P). Individual treatment systems are used to treat specific 'target' pollutants, but consideration should be given to 'secondary pollutants' that are not removed by, or even inhibit, the treatment as these may constrain the applicability of the treatment method
- balance of cross-media effects (air, wastes and energy)
- financial feasibility
- organisational and technical feasibility.

The chosen treatment technique may involve a combination of physical, chemical and biological methods. The following paragraphs give brief, generic descriptions of typical waste water streams that originate from LVOC processes and the possible treatment techniques. Further details may be found in the horizontal BREF.

- **Acid/alkaline effluents.** A suitable neutralising agent can be added to adjust pH. Wherever possible, other wastes (and not virgin raw materials) should be used for neutralisation. In some cases the acid dosing of effluents may release toxic gases.
- **Mixtures of oil/organics and water.** The two phases can be separated using such techniques as tilted plate separators, American Petroleum Institute (API) separators, air flotation, coalescing agents or hydrocyclones.
- **Biodegradable organics.** Biodegradable material (as measured by BOD) may be biologically degraded, normally using aerobic microbial activity (but anaerobic activity has applications as a pre-treatment technique). The treatability of effluent will depend on the presence of inhibitory materials, the absence of necessary nutrients, the pollutant concentration and pollutant variability. The steam or air stripping of volatile components may be required in preparation for biological treatment.

- **High organic load.** Conventional aerobic or anaerobic biological treatment may not be applicable to effluents with high organic concentrations if they are toxic or difficult to degrade. It may be necessary to use various forms of extreme oxidation such as incineration, wet oxidation, or supercritical water oxidation. All techniques have significant capital and operating costs, but these are often difficult to identify when process effluents pass to a central waste water treatment plant. However, estimates have been made of the costs of treating a high organic load effluent with different techniques (Table 5.15).

Abatement technique	Capital cost (£000)	Operating cost (£000 per annum)	Annualised cost (£)	Unit cost (£/m ³)
Incineration	4000	1750	2400	60
Wet air oxidation	5000	360	1170	29
Supercritical water oxidation	7000	690	1830	46

Assumption – effluent flow of 5 m³/h with organic concentration of 5000 mg/l

Table 5.15: Treatment cost of a high-organic effluent
[Environment Agency (E&W), 1998 #1]

- **Recalcitrant organics.** Recalcitrant organics are organics that are not efficiently removed by biodegradation but may be removed efficiently by appropriate pre-treatment or incineration. This refers to single substances and to tributary effluents with BOD:COD <4. Some long chain aliphatics, aromatics and highly chlorinated compounds are difficult to biodegrade and may need to be treated by activated carbon adsorption, other adsorption techniques, hydrolysis, filtration or advanced oxidation techniques. The amenability to biological treatment can be improved by steam or air stripping to remove the volatile components. Where the volatiles are chlorinated species the off-gases are passed to an incinerator. A cost comparison is given in Table 5.16.

Abatement technique	Capital cost (£000)	Operating cost (£000 per annum)	Annualised cost (£)	Unit cost (£/m ³)
Granulated activated carbon	400	67	132	0.37
Hydrogen peroxide plus UV light	500	52	133	0.37

Assumption – effluent flow of 45 m³/h with trichloroethylene concentration of 5 mg/l

Table 5.16: Treatment cost of a halogenated effluent
[Environment Agency (E&W), 1998 #1]

- **Suspended solids.** Solids may need to be removed as a precursor to further treatment or as a polishing step prior to discharge. The techniques include settlement, flotation, precipitation and filtration. The solids produced by these techniques will need to be de-watered and dried prior to disposal. Removal efficiencies can be improved by the use of coagulants and flocculants.
- **Metals.** Metals may occur in effluents, for example, through the use of catalysts. Metals generally need to be removed by separate treatment, because they can not be removed efficiently in biological treatment plants. The impact of heavy metals on a biological treatment facility must be evaluated with regard to inhibitory effects, sludge deterioration effects and residual pollutant levels in the effluent. Whenever unacceptable effects are expected, the individual waste water stream needs separate treatment or central (combined) special treatment, using such treatment methods as chemical precipitation (creating a sludge that may allow metal recovery), ion exchange, electrolytic recovery or reverse osmosis. Metals also make the re-use of biosludge (e.g. in agriculture) more difficult.

5.4.3 Monitoring of water emissions

General information on the monitoring of water emissions may be found in the horizontal BREF on Monitoring [EIPPCB, Draft #51].

Bio assays ('Whole Effluent Assessments') are an important tool for the evaluation of LVOC waste waters both before and after treatment. A lot of experience has been gathered concerning acute toxicity and this is well established with respect to emission standards, authorisation requirements or waste water fees at some member states. For further information see OSPAR workshop on whole effluent assessment, 1999; and Final report EU-LIFE-project Estimation methods of industrial wastewater pollution in the Meuse basin, 1998 [UBA (Germany), 2000 #126]. Further details may also be found in the horizontal BREF on WWWG treatment / management [EIPPCB, Draft #48].

Whilst there are no standard methods for the assessment of chronic effluent toxicity, bioaccumulation, mutagenicity and persistence, there are ongoing developments (at ISO, CEN, OECD). Two procedures for evaluation of raw data from toxicity tests are performed:

- the EC/LC50 approach uses statistical analysis of data after transformation to an appropriate distribution (e.g. log / probit-transformation). A concentration / response-relationship is assumed and at least 5 data pairs between 0 % and 100 % response are needed
- the LID approach (Lowest Ineffective Dilution) uses as the test result the reciprocal value (or dilution factor) of the wastewater at which no effects are observed. LID results are referred to as T- or G-values in Annex I. For example, the test result $TF = 2$ means that there is no observed toxic effect with a 2-fold dilution of the sample (e.g. acute toxicity against fish). No concentration / response relationship is needed and the test procedure may be simpler, but no statistical evaluation and confidence limits can be assigned.

In principle both evaluation methods give information of hazardous wastewater concentrations and might be transformed into each other from raw data. The only advantage of the LID-approach is that cost-effective screening procedures can be performed. Further information can be found in 'Ecotoxicological evaluation of waste water within Whole Effluent Assessment' (Draft OSPAR background document concerning the elaboration of programmes and measures relating Whole Effluent Assessment; November 1999, p77).

Toxicity assessment is a particularly valuable sum-parameter for evaluating the complex waste streams that arise from the LVOC industry. The Dutch classification system for effluent toxicity [InfoMil, 2000 #83 83] is based on the percentage of wastewater added to the testing environment and uses the EC/LC50 approach. If the wastewater is diluted more than 100 times (i.e. <1 vol. %) and still 50 % of the test organisms die from acute intoxication (LC50), then the wastewater is qualified as 'very strongly toxic'. The full range of categories is:

- | | |
|-----------------------|-----------------|
| • very strongly toxic | <1 vol. % |
| • strongly toxic | 1 - 10 vol. % |
| • toxic | 10 - 50 vol. % |
| • minor toxic | 50 - 100 vol. % |
| • not toxic | > 100 vol. % |

A statistical analysis of bioassay data in Germany for the effluents of chemical sites showed that, by appropriate measures, acute toxicity (LID-values) has been reduced to very low levels. Effluents from LVOC processes are generally found in the lower part of the following ranges unless high concentrations of salt affect the measured values.

	T _{Fish}	T _{Daphnia}	T _{Lumin· bacteria}	T _{Algae}
Number of tests	599	879	830	387
Median (LID)	2	2	2	1
90- percentile	3	4	12	16

5.5 Wastes

5.5.1 Waste prevention

Waste is an important issue in the chemical industry and there are generally strong economic and environmental incentives to reduce generation. Waste audits are used to gather information on the source, composition, quantity and variability of all wastes. As a rule of thumb, prevention techniques should be adopted according to the waste management hierarchy, namely [Environment Agency (E&W), 1999 #6]:

- **Prevent waste arisings at source:** Those wastes that are generated by incomplete conversion, degradation or destruction of the raw materials (e.g. tars, unwanted by-products) can be an indicator of process inefficiency and are avoided by process-integrated measures that optimise the raw materials, operating conditions or even the process route.
- **Minimise any unavoidable arisings of waste:** Many process agents (e.g. acids, caustic, clay, solvents) generate waste (e.g. spent acid, spent caustic, spent clay, spent solvents). These are high-volume, low-value waste streams that are often polluted by the process chemicals and are difficult to treat in a cost-effective way. If the use of such process agents is necessary, the aim is to minimise the consumption (e.g. by extending catalyst life) and to find a useful outlet for the generated waste.
- **Recycling of waste** - either internally or externally. Spent catalysts are commonly regenerated, especially if they contain precious or toxic metals, but this should only be after their use in the process has been questioned and catalyst deactivation has been minimised by optimising the process conditions. The recovery of metals from catalysts may be covered by the BREF on 'Non ferrous metals'.

5.5.2 Waste control

The choice of treatment technique is very specific to the process and the type of waste arisings. Waste generation is so specific to the processes operated that it is not possible to identify generally achievable emission levels. In addition, many plants do not treat their own waste and instead contract-out to specialised companies.

Wherever the control techniques are operated, there is a need for systems to manage the storage, handling, transportation and disposal/destruction of waste. Waste is usually classified according to the amount or concentration of 'dangerous' components (e.g. heavy metals, persistent organic chemicals) and the physical/chemical properties of the waste (e.g. pyrophoric, leaching).

As a general rule of thumb, the following techniques are used to treat the waste types that were identified in Section 4.3.

- **Catalysts.** Catalysts have a finite life because of chemical deactivation, physical degradation or fouling. Catalysts are often based on expensive, exotic metals and this provides an economic incentive for catalyst regeneration (either on or off site). Inert catalyst supports are landfilled when they are physically no longer useful.

- **Spent purification media.** Media such as activated carbon, molecular sieves, filter media, desiccants, and ion exchange resins are used to purify the product of impurities. Where possible the media are regenerated, but landfill disposal and incineration (under appropriate conditions) may also be used.
- **Organic process residues.** The heavy organic residues from distillation columns and vessel sludges etc. may be used as feedstock for another process or as a fuel to capture the calorific value. Where this is not possible, they are incinerated (under appropriate conditions).
- **Spent reagents.** Where spent reagents (e.g. organic solvents) cannot be recovered or used as a fuel, they are normally incinerated (under appropriate conditions).

5.6 Heat

Although less obvious than air and water emissions, ‘heat’ is defined as an emission under Article 2 of the IPPC directive. The existence of heat releases may be indicative of a process that has poor energy efficiency. Improved energy efficiency has the economic benefit of reducing energy costs and the environmental benefits of reducing heat releases and the emission of carbon dioxide.

The techniques for minimising heat releases from the LVOC industry are very dependent on the local circumstances of a process. In general, new plants provide better opportunities for energy savings than existing plants.

‘Hard’ techniques could include the installation of new technology, process adaptations, heat exchange and minor equipment improvements. Thermal insulation is fitted to vessels and pipes where this minimises energy usage, the degradation of materials and fluctuations in process temperature.

Conventional stand-alone power stations have overall energy efficiencies of only 35 - 40 %, but power-and-heat integration on large scale integrated chemical plants can produce overall energy efficiencies of 70 - 90 % [CEFIC, 1999 #17]. LVOC processes can also provide opportunities for improved efficiency by considering energy integration beyond the site boundary (e.g. heat transfers to other sites – so called ‘industrial ecology’, district heating, CO₂ export) [InfoMil, 2000 #83].

There is also an important role for ‘soft’ techniques based on environmental management systems. This may include the full attribution of energy costs to each process, the internal reporting of energy use/efficiency, external benchmarking, and energy audits using Pinch Analysis™. Pinch Analysis™ first identifies all heat sources and sinks in a process and then reconciles heat transfers to optimise overall energy efficiency. For example, the energy generated by an exothermic reaction can be transferred (either directly or indirectly) to equipment that has a heating requirement. Such energy audits should be an integral part of approving any significant process change.

It may not be feasible, due to technical or economic reasons, to use the lowest levels of energy that originate from a process. This energy may be transferred into the environment by air cooling-and/or water cooling-systems. But cooling systems should be seen as the last resort for treating arisings of heat.

5.7 Vibration

Vibration is also defined as an emission under Article 2 of EC directive 96/61/EC. A combination of primary and secondary measures can be used to reduce vibrations, and these could include:

- selection of equipment with inherently low vibration (e.g. steadily running machines instead of pulsating machines; screw compressors instead of reciprocating compressors)
- anti-vibration mountings (e.g. pumps mounted on rubber foundations)
- disconnection of vibration sources and surroundings (e.g. separate foundations for reciprocating compressor and any connected pipes)
- consideration at the design stage of proximity to potential receptors (e.g. residential areas).

5.8 Noise

Noise is also defined as an emission under Article 2 of EC directive 96/61/EC. Noise is a constant feature of most LVOC installations, but particular issues may arise from such equipment as compressors, pumps, flares and steam vents.

A combination of primary and secondary measures can be used to reduce noise, for example:

- noise prevention by suitable construction (e.g. prevention of resonant vibration)
- sound absorbers (e.g. for safety valves, combustion machines)
- noise control booth / encapsulation of the noise sources (e.g. compactors, centrifuges)
- noise-reducing layout of buildings
- consideration at the design stage of proximity to potential receptors (e.g. residential areas).

Table 5.17 gives the Swedish Environment Protection Agency target values for external noise exposure from new and existing industrial installations [SEPA, 2001 #146].

Surrounding environment	Equivalent sound level in dBA			Maximum sound level; 'FAST' measurement
	Daytime (07 – 18)	Evening (18 - 22,) Sundays & holidays (07 – 18)	Night (22 – 07)	Instantaneous sound at night (22 – 07)
Workplaces for silent activities	New 60 Existing 65	New 55 Existing 60	New 50 Existing 55	-
Housing and recreational areas near housing; educational premises and nursing buildings	New 50 Existing 55	New 45 Existing 50	New 40 ⁽¹⁾ Existing 45 ⁽¹⁾	New & existing 55
Areas for recreation; outdoor life, where the experience of nature is important ⁽²⁾	New 40 Existing 45	New 35 Existing 40	New 35 Existing 40	New & existing 50
1. Night requirements need not be applied to educational premises 2. Only where the area plan denotes them as thus planned				

Table 5.17: Target values for external industrial noise from new and existing installations [SEPA, 2001 #146]

Particular points in the application of the Swedish noise guidelines are [SEPA, 2001 #146]:

- The target values are viewed in conjunction with the local circumstances of individual installations and actual permit conditions may be higher or lower.
- The 'New installation' values are the long-term aim of existing installations and are applied to existing installations where technically and economically feasible.
- The target values apply to activities that are carried on for an entire period (i.e. day, evening or night) and equivalent sound levels are calculated where activities are for incomplete periods.
- If the sound contains repetitive impulses (e.g. from riveting, conveyors, unloading of scrap-iron, etc.) and/or contains audible tone components, then the equivalent sound level value is 5 dBA lower than shown in the above table.
- The expansion of a particular plant should not result in an increased sound level from the whole installation.
- For existing installations, immediate noise-reducing actions are required if any target value is exceeded by more than 5 dBA.

The measurement of noise levels under the Swedish guidelines has the following requirements [SEPA, 2001 #146]:

- Equipment. Measurement of equivalent sound level should be performed with a dosimeter. In cases where a sound level device is used it should fulfil the requirements of IEC 179 (precision sound level gauge) or IEC-651 (type 1). When a sound level gauge is used its A-filter should be active, and the measurement mode is in position 'FAST'. The microphone should have a windshield.
- Conditions. Measurement should be performed downwind and at an average wind velocity of less than 5 m/s (as measured at a height of 10m). With wind velocities below 2 m/s, measurement should be carried out in clear weather by night. For enterprises that are run continuously, measurement at night is preferred. The background noise level should be at least 10 dBA lower than the level from the establishment. If possible the background level should be registered at the same time. In some cases a background level calculation may be appropriate, for instance for road traffic noise.
- Measurement points. The sound level should be measured in representative points in the areas that surround the industry. These should always include nearby housing even if they do not border on the site under discussion. A minimum of four measurement points should be used, each of which fulfils the requirements for free field measurements. Measurement should be done 1.5 m above ground. A free field measurement is not influenced by reflections. Situations where the distance to a reflecting surface has a satisfactory damping effect as compared to direct sound may also be considered to be free field. Under certain conditions, reflection measurements may be used as well. Control of a single noise reduction action should be done through measurement of the change in sound emission and not noise exposure.

5.9 Tools for the evaluation of techniques

The IPPC directive requires a cost / benefit consideration in the determination of Best Available Techniques, but it is very difficult to arrive at cut-off points for excessive cost because the industry is very heterogeneous. The factors that are relevant in assessing whether environmental abatement costs can be supported by an industrial sector may include [Environment Agency (E&W), 1999 #7]:

- at some times in the business cycle, companies in the sector generate substantial cash flow while at other times they may suffer a cash shortage or deficit
- special factors such as exchange rate fluctuations can affect profitability
- it is not meaningful to quote environmental costs as a percentage of margin for a single year since averaging across the business cycle is needed
- commodity producers cannot pass on cost increases that apply only to them
- the position of a plant on the cash cost curve determines whether it breaks even or suffers a significant cash drain in poor times. In practice, this seriously influences companies' decisions on plant closure and exit from the business.

Typical parameters for assessing the ability of a sector to support environmental expenditure are operating profits and levels of investment. Operating profits for the bulk organic chemical industry are highly dependent on the stage of the business cycle and the process, but typically range from -5 % to 15 % of gross revenue. If major acquisitions and expansions are omitted, then fixed investment typically ranges between 1 % and 6 % of gross revenues [Environment Agency (E&W), 1999 #7].

Although new process technology and environmental control techniques may bring financial advantages in addition to improved environmental performance. Some major process changes may only be valid for new installations, but existing processes can also provide opportunities for improvement. The modification of existing processes is often difficult because of equipment specifications and retrofitting costs.

It is often difficult to identify which techniques provide the best solutions from an environmental and economic point of view, and a whole spectrum of environmental tools has been developed to support this decision making. The horizontal BREF on 'Economic and Cross-Media Issues' may provide additional guidance. A useful overview of available tools can be found in [InfoMil, 2000 #83] and this can be summarised as:

- **Risk analysis and dispersion models:** to assess the impact of emissions, or simulated accidents, on the local environment.
- **Chain analysis methods:** to analyse pollutants, products or raw materials from the 'cradle to the grave'. The methods include Mass Balances (to quantify the flow of material in a plant or sub-plant area), and Life Cycle Analysis (LCA) (often associated with the comparison of two or more products, but also used to compare different production processes or different techniques).
- **Planning instruments:** help to predict the potential future environmental impact of a company and to develop a strategy to reduce that impact (e.g. Environmental Impact Assessment (EIA), Company Environmental Plans).
- **Economic analysis methods:** to support the economic evaluation of environmental protection techniques. This involves calculating the total costs of a technique (capital costs, operational costs, etc.); the reasonableness of those costs in general (reference values for cost effectiveness); and the reasonableness of the costs for the specific sector or company (carrying capacity). The methods include Cost-Effectiveness, Life Cycle Costing and Shadow Prices Method.
- **Environmental weighting methods:** to compare different environmental aspects with each other in a transparent and 'objective' way. All the methods make the comparison using a set of weighting factors that are derived from: environmental quality requirements; the Panel or Delphi method; Distance to target; or Shadow prices.
- **Other instruments:** Of the many other methods available to companies and licensing authorities to assist in the decision making, some important methods are: Energy Pinch, Water Pinch and Benchmarking.

5.10 Application of techniques to existing installations

Since the likelihood of major new LVOC facilities being built in Europe is low, environmental improvement in the sector is normally achieved by retrofitting (revamping) existing installations.

Specific assessment of the suitability of a technique for retrofitting is required in each case, but many of the techniques mentioned in this BREF have already been successfully retrofitted to LVOC installations and deliver an environmental performance equivalent to that which could be expected from new plants. Revamp projects on existing installations encounter a variety of technical and managerial issues, the most common of which are outlined below (see CEFIC paper [CEFIC, 2001 #151] for further detail). These issues are not excuses to avoid the adoption of environmental improvement techniques but are some of the factors pertinent to a revamp:

- a more complex and time-consuming project definition phase
- consideration at the design stage of knock-on effects on all existing facilities
- surveys of the existing facilities at the detailed engineering stage to define the exact location of all interfaces. Space availability may introduce constraints (e.g. equipment placed in an elevated structure, pipe routing, need to relocate some existing facilities, construction of temporary facilities)
- special precautions so that works can be carried out safely, and without damage, even while the plant continues to operate
- taking advantage of a planned shutdown (turnaround) to carry out any construction work that cannot be done during normal operations. These multi-year events may dictate revamp timing
- a longer, or earlier, shutdown than planned (with commercial and financial implications)
- the decommissioning and dismantling of old, redundant equipment

In addition to the prime purpose of improved environmental performance, the retrofitting of installations can confer other significant benefits. Some techniques bring major economic returns in the form, for example, of increased efficiency and higher yields or of cost reductions associated with savings of energy, water and auxiliaries, that can offset the investment and operating costs of the retrofit. Retrofitting can also bring competitive advantage by showing product buyers and stakeholders (e.g. shareholders, local communities, regulators and environmental groups) that the company has adopted cutting edge technology.

Experience shows that extra costs may be incurred in the retrofitting of new equipment to existing chemical plants. As an example Table 5.18 describes costs for the installation of typical pieces of equipment used in LVOC processes. Note that the terms ‘easy revamp’ and ‘difficult revamp’ are subjective and have not been defined.

Installation & connection of a new:		Cost of:						
		Purchase (remainder)	Purchase, erection & connection	Dis-mantling of existing	Hardware investment	Basic & detailed engineering	Grand total ⁽¹⁾	Cost ratio
Pump	Grass root	(100)	206	0	206	40	246	1.0
	Easy revamp	(100)	233	21	254	60	314	1.27
	Difficult revamp	(100)	279	61	340	80	420	1.7
Carbon steel vessel (> 2m ³)	Grass root	(100)	367	0	367	73	440	1.0
	Easy revamp	(100)	383	37	420	95	515	1.17
	Difficult revamp	(100)	429	133	562	128	690	1.57
Carbon steel heat exchanger	Grass root	(100)	310	0	310	60	370	1.0
	Easy revamp	(100)	322	32	354	76	430	1.16
	Difficult revamp	(100)	355	90	445	105	550	1.48
Carbon steel column, excluding internals	Grass root	(100)	345	0	345	70	415	1.0
	Easy revamp	(100)	362	35	397	91	488	1.18
	Difficult revamp	(100)	425	112	537	123	660	1.59

(1). Excluding license cost, contingency provisions taken during cost estimation and financial cost.

Table 5.18: Comparison of installation and connection costs [CEFIC, 2001 #151] - courtesy of ATOFINA

In terms of whole project costs (rather than individual pieces of equipment) there is not only the price of the environmental facility but also the additional capital costs for piping, engineering, special constructional provisions etc. These additional costs can be a significant proportion (30 - 250 %) of the price of the environmental facility. Table 5.19 gives examples of the additional costs for projects involving a variety of end-of-pipe and process-integrated techniques:

	Simple situation	Complex situation
New installation	+ 30 – 50 %	+ 50 – 100 %
Existing installation	+ 50 – 100 %	+ 100 – 250 %

Table 5.19: Additional capital costs to the basic costs of an environmental investment [InfoMil, 2000 #83]

A variety of economic evaluation methods can be used to assess environmental improvement techniques and there are three important aspects to the economic evaluation at plant or company level; namely:

- the calculation of the cost of the measure (capital costs, operational costs, etc.), sometimes also combined with the environmental benefits (cost-effectiveness)
- the reasonability of the costs in general (reference values for cost effectiveness)

Further information may be found in the BREF on Economic and Cross-media issues [EIPPCB, Draft #52] but some examples of economic analysis methods are [InfoMil, 2000 #83]:

- **Cost effectiveness:** The cost-effectiveness method provides a tool to standardise the calculation of investment and operational costs and makes measures in different companies comparable. The method also includes the environmental improvement that can be achieved by implementing the measure. The results are expressed in '€ per tonne pollutant reduced'. Thus, it points directly to the measures that are most cost-effective.
- **Life Cycle Costing:** Life Cycle Costing is a basic concept that adheres to cost accounting methods that take the life cycle of a product or process into account. There are two basic types: internal LCC and external LCC. Internal LCC methods only take the internal costs into account (e.g. all costs made by the company). External LCC methods take into account also societal costs (e.g. the value of monuments, ecosystems, people). Internal LCC methods are more generally accepted and applied (e.g. cost effectiveness). External LCC methods are only just gaining importance. However, in general LCC methods are not applied commonly in the LVOC industry.
- **Shadow Prices Method:** The Shadow Prices method is an economic analysis method that supports the prioritising of (sets of) environmental measures. It is based on the presence of environmental goals and on the assumption that society (and companies) wants to achieve the environmental goals in the most cost-effective way. Thus, cheapest measures are taken first. The 'Shadow Price' is the price (per unit pollutant) that must be paid for the last (and most expensive) measure that is necessary to achieve the environmental goal (c.f. marginal cost calculation). In an indirect way, by using the environmental goals, the method takes into account societal costs. It produces a 'reasonability criterion' for investments in environmental measures. This method is not commonly applied in the LVOC.

6 GENERIC BAT (BEST AVAILABLE TECHNIQUES)

6.1 Introduction

In understanding this chapter and its contents, the attention of the reader is drawn back to the preface of this document and in particular the fifth section of the preface: “How to understand and use this document”. The techniques and associated emission and/or consumption levels, or ranges of levels, presented in this chapter have been assessed through an iterative process involving the following steps:

- identification of the key environmental issues for the sector
- examination of the techniques most relevant to address those key issues
- identification of the best environmental performance levels, on the basis of the available data in the European Union and world-wide
- examination of the conditions under which these performance levels were achieved; such as costs, cross-media effects, main driving forces involved in implementation of this technique
- selection of the best available techniques (BAT) and the associated emission and/or consumption levels for this sector in a general sense all according to Article 2(11) and Annex IV of the Directive.

Expert judgement by the European IPPC Bureau and the relevant Technical Working Group (TWG) has played a key role in each of these steps and in the way in which the information is presented here.

On the basis of this assessment, techniques, and as far as possible emission and consumption levels associated with the use of BAT, are presented in this chapter that are considered to be appropriate to the sector as a whole and in many cases reflect current performance of some installations within the sector. Where emission or consumption levels “associated with best available techniques” are presented, this is to be understood as meaning that those levels represent the environmental performance that could be anticipated as a result of the application, in this sector, of the techniques described, bearing in mind the balance of costs and advantages inherent within the definition of BAT. However, they are neither emission nor consumption limit values and should not be understood as such. In some cases it may be technically possible to achieve better emission or consumption levels but due to the costs involved or cross media considerations, they are not considered to be appropriate as BAT for the sector as a whole. However, such levels may be considered to be justified in more specific cases where there are special driving forces.

The emission and consumption levels associated with the use of BAT have to be seen together with any specified reference conditions (e.g. averaging periods).

The concept of “levels associated with BAT” described above is to be distinguished from the term “achievable level” used elsewhere in this document. Where a level is described as “achievable” using a particular technique or combination of techniques, this should be understood to mean that the level may be expected to be achieved over a substantial period of time in a well maintained and operated installation or process using those techniques.

Where available, data concerning costs have been given together with the description of the techniques presented in the previous chapter. These give a rough indication about the magnitude of costs involved. However, the actual cost of applying a technique will depend strongly on the specific situation regarding, for example, taxes, fees, and the technical characteristics of the installation concerned. It is not possible to evaluate such site-specific factors fully in this document. In the absence of data concerning costs, conclusions on economic viability of techniques are drawn from observations on existing installations.

It is intended that the general BAT in this chapter are a reference point against which to judge the current performance of an existing installation or to judge a proposal for a new installation. In this way they will assist in the determination of appropriate "BAT-based" conditions for the installation or in the establishment of general binding rules under Article 9(8). It is foreseen that new installations can be designed to perform at or even better than the general BAT levels presented here. It is also considered that existing installations could move towards the general BAT levels or do better, subject to the technical and economic applicability of the techniques in each case.

While the BREFs do not set legally binding standards, they are meant to give information for the guidance of industry, Member States and the public on achievable emission and consumption levels when using specified techniques. The appropriate limit values for any specific case will need to be determined taking into account the objectives of the IPPC Directive and the local considerations.

What is Generic BAT?

This chapter describes those techniques that are considered to be BAT for processes in the LVOC sector as a whole, regardless of the process or product. Readers should note that, as a result of the boundaries established for IPPC information exchanges, the Generic BAT has been derived not only from the techniques described in Chapter 5 of this document but also relevant techniques described in horizontal BREFs (especially the BREF on Waste water / waste gas management and treatment).

BAT for a particular LVOC process is, however, determined by considering the three levels of BAT in the following order of precedence:

- illustrative process BAT (where it exists)
- LVOC Generic BAT; and finally
- any relevant Horizontal BAT (especially from the BREFs on waste water / waste gas management and treatment, storage and handling, industrial cooling, and monitoring).

Generic BAT in this chapter is described in terms of management systems (Section 6.2), pollution prevention / minimisation (Section 6.3), air pollutant control (Section 6.4), water pollutant control (Section 6.5) and wastes / residues control (Section 6.6). Note that the environmental performance of a Generic BAT will not be identical in every LVOC process. Conversely, it may be possible to achieve the same environmental performance by using different BATs.

6.2 Management systems

Effective and efficient management systems are very important in the attainment of high environmental performance in LVOC processes. BAT for environmental management systems is an appropriate combination or selection of the following techniques:

Policy:

1. formulation of an environmental strategy by the highest management level of a company and a commitment to follow the strategy
2. clear organisational structures to ensure that the responsibility for environmental issues is fully integrated into the decision-making by all employees
3. written procedures or practices for all environmentally important aspects of plant design, operation, maintenance, commissioning (start-up) and decommissioning
4. internal audit systems to review the implementation of environmental policies and to verify compliance with procedures, standards and legal requirements

5. accounting practices that internalise the full costs of raw materials (including energy) and waste disposal / treatment
6. long term financial and technical planning for environmental investments
7. a consideration of 'Industrial Ecology', i.e. the impact of a process on its surroundings and the opportunities for better efficiency and environmental performance.

Process design:

1. review of the environmental implications of all raw materials, intermediates and products
2. identification and characterisation of all planned and potential unplanned releases
3. segregation of wastes at source (to facilitate their re-use and treatment)
4. treatment of waste streams at source (to exploit high concentration / low flow streams)
5. provision of flow and load buffering
6. installation of back-up abatement systems (if required)
7. give provision to allow, or ease, the 'Process operation' techniques given below.

Process operation:

1. use of control systems (hardware and software) for both the core process and pollution control equipment to ensure stable operations, high yields and good environmental performance under all operational modes
2. implementation of systems to ensure operator environmental awareness and training
3. defined response procedures to abnormal events
4. the availability of continuous process control checks / monitoring data on critical environmental parameters to detect abnormal operating conditions / emissions, and the provision of associated systems to ensure their prompt remediation
5. the use of preventative and, when needed, reactive inspection and maintenance to optimise the performance of process plant and equipment
6. consider and evaluate the need to treat emissions from depressurising, emptying, purging and cleaning of equipment in air or water pollution abatement systems
7. implementation of a waste management system that includes ongoing waste minimisation to identify and implement techniques that reduce emissions and raw material consumption.

6.3 Pollution prevention and minimisation

The selection of BAT for LVOC processes, for all environmental media, is to give sequential consideration to techniques according to the following hierarchy:

- a) eliminate the arisings of all waste streams (gaseous, aqueous and solid) through process development and design, in particular by ensuring that the reaction step has high selectivity and the proper catalyst
- b) reduce waste streams at source through process-integrated changes to raw materials, equipment and operating procedures, with particular attention to the work-up step (minimise losses and degradation of valuable product) and smooth operating conditions
- c) recycle waste streams by direct re-use or reclamation / re-use
- d) recover any resource value from waste streams
- e) treat and dispose of waste streams using end-of-pipe techniques.

BAT for the design of new LVOC processes, and for the major modification of existing processes, is an appropriate combination or selection of the following techniques:

1. to carry out chemical reactions and separation processes continuously, in closed equipment
2. to subject continuous purge streams from process vessels to the hierarchy of: re-use, recovery, combustion in air pollution control equipment, and combustion in non-dedicated equipment
3. to minimise energy use and to maximise energy recovery

4. to use compounds with low or lower vapour pressure
5. give consideration to the principles of 'Green Chemistry' as described in Section 5.2.1.

BAT for the prevention and control of **fugitive emissions** is an appropriate combination or selection of the following techniques:

1. Implement a formal Leak Detection and Repair (LDAR) programme to focus on the pipe and equipment leak points that provide the highest emission reduction per unit expenditure.
2. Repair pipe and equipment leaks in stages, carrying out immediate minor repairs (unless this is impossible) on points leaking above some lower threshold and, if leaking above some higher threshold, implement timely intensive repair. The exact threshold leak rate at which repairs are performed will depend on the plant situation and the type of repair required.
3. Replace existing equipment with higher performance equipment for large leaks that cannot otherwise be controlled.
4. Install new facilities built to tight specifications for fugitive emissions.
5. Where existing equipment is replaced, or new equipment installed, the BAT is:
 - **valves**: low leak rate valves that use double packing seals or equally efficient high performance equipment. For high-risk duty (e.g. toxic substances) the use of bellow seals or equally efficient high performance equipment.
 - **pumps**: double seals with liquid or gas barrier, or seal-less pumps (magnetically driven or canned) or equally efficient high performance equipment.
 - **compressors and vacuum pumps**: double seals with liquid or gas barrier, or seal-less pumps (magnetically driven or canned), or single seal technology with equivalent emission levels, or equally efficient high performance equipment.
 - **flanges**: minimise the number, use effective gaskets.
 - **open ends**: fit blind flanges, caps or plugs to infrequently used fittings; use closed loop flush on liquid sampling points; and, for sampling systems / analysers, optimise the sampling volume/frequency, minimise the length of sampling lines or fit enclosures.
 - **safety valves**: bearing in mind the top priority of safety, consider reduction measures (e.g. upstream rupture disk, discharge to air emission control system).
6. Adopt the following general measures as necessary:
 - double isolation at any points with high risk of leakage
 - obviate the need for vessel opening through design modifications or mode of operation
 - enclose effluent collection systems and tanks used for effluent storage / treatment
 - monitor cooling water for contamination with organics
 - depending on leak rate, convey compressor seal leaks and purges to a lower pressure system (closed network operated at lower pressure) for re-use or flaring.

In addition to BAT in the Storage BREF [EIPPCB, Draft #49], BAT for **storage, handling and transfer** is an appropriate combination or selection of the following techniques:

1. external floating roof with secondary seals (except for highly dangerous substances)
2. fixed roof tanks with internal floating covers and rim seals (for more volatile liquids)
3. fixed roof tanks with inert gas blanket (e.g. when needed for safety reasons)
4. pressurised storage (for highly dangerous or odorous substances)
5. minimise the storage temperature (although this may have impacts on viscosity or solidification)
6. instrumentation and procedures to prevent overfilling
7. impermeable secondary containment with a bund capacity of 110 % of the largest tank
8. recovery of VOCs (by condensation, absorption or adsorption) before recycling or destruction by combustion in an energy raising unit, incinerator or flare.
9. continuous monitoring of liquid level and changes in liquid level.
10. tank filling pipes that extend beneath the liquid surface
11. bottom loading to avoid splashing

12. vapour balance lines that transfer the displaced vapour from the container being filled to the one being emptied
13. back-venting to suitable abatement plant
14. sensing devices on loading arms to detect undue movement
15. self-sealing hose connections / dry break coupling
16. barriers and interlock systems to prevent damage to equipment from the accidental movement or drive-away of vehicles.

BAT for preventing and minimising the emission of **water pollutants** is an appropriate combination or selection of the following techniques:

- A. Identify all waste water arisings and characterise their quality, quantity and variability.
- B. Minimise water input to the process by the use of:
 1. water-free techniques for vacuum generation and cleaning
 2. counter-current washing systems in preference to co-current systems
 3. water sprays (rather than jets)
 4. closed-loop cooling water cycles
 5. roofing the installation to minimise storm-water ingress (when compatible with health and safety)
 6. management tools such as water-use targets and transparent costing of water
 7. water meters within the process to identify areas of high use.
- C. Minimise process water contamination with raw material, product or wastes by the use of:
 1. plant equipment and effluent collection systems made from corrosion resistant materials to prevent leaks and reduce metal dissolution into waste water.
 2. indirect cooling systems (unless required for process reasons)
 3. purer raw materials and auxiliary reagents
 4. non-toxic or lower toxicity cooling water additives
 5. drum storage on concrete hard-standing that drains to a holding sump
 6. spill clean-up material at strategic points around the installation
 7. spill contingency plans
 8. dry clean-up methods
 9. regular checks for leaks and systems for prompt repair
 10. separate collection systems for contaminated process effluent, sewage, uncontaminated water, and effluents containing mineral oil
 11. uncontaminated drains
 12. containment areas for fire-fighting water
 13. concrete hard-standing in loading/unloading areas with kerbs / 'sleeping policemen' (low-level road humps for traffic calming) that drain to a sump
 14. effluent collection systems (pipes and pumps) either placed above ground or placed in ducts accessible for inspection and repair, or leak-free sewers (e.g. welded HDPE, GRP)
 15. buffer tank upstream of the effluent treatment plant.
- D. Maximise waste water re-use by the use of:
 1. defining the lowest water quality that can be used for each activity in the process
 2. identifying options for the waste water re-use commensurate with the waste water quality
 3. providing storage tanks for waste water to balance periods of generation and demand
 4. utilising separators to facilitate the collection of water-insoluble materials.
- E. Maximise the recovery / retention of substances from mother liquors unfit for re-use by optimising processes and especially by improvement of mother liquor work-up.

The prevention of **groundwater** pollution is to be given special attention. BAT is an appropriate combination or selection of the following techniques:

1. storage tanks and loading/unloading facilities designed so as to prevent leaks and to avoid soil and water pollution caused by leaks
2. overflow detection systems (e.g. high-high level alarms and automatic cut-off)
3. use of impermeable ground materials in the process area with drainage to sump
4. no intentional discharges to ground or groundwater
5. collection facilities where leaks may occur (e.g. drip trays, catch pits)
6. equipment and procedures to ensure the full draining of equipment prior to opening
7. leak detection systems and maintenance programme for all vessels (especially underground tanks) and drains
8. monitoring of groundwater quality.

BAT for preventing and minimising the generation of **residues and wastes** is:

1. prevent waste arisings at source
2. minimise any unavoidable arisings of waste
3. maximise the recycling of waste.

BAT for **energy efficiency** is an appropriate combination or selection of the following techniques:

1. optimise energy conservation (e.g. by the thermal insulation of process equipment)
2. implement accounting systems that fully attribute the energy costs to each process unit
3. undertake frequent energy reviews
4. optimise heat integration at the inter-process and intra-process levels (and where possible beyond the site boundary) by reconciling heat sources and sinks
5. use cooling systems only when the re-use of energy sources from the process has been fully exploited
6. adopt Combined Heat and Power (CHP) systems where economically and technically viable.

BAT for the prevention and minimisation of **noise and vibration** is an appropriate combination or selection of the following techniques:

1. consideration, at the design stage, of the proximity to potential receptors
2. selection of equipment with inherently low noise and vibration levels
3. anti-vibration mountings for process equipment
4. disconnection of vibration sources and surroundings
5. sound absorbers or encapsulation of the noise sources
6. periodic noise and vibration surveys.

6.4 Air pollutant control

The following BAT for air pollutants presume the optimisation of BAT for environmental management and prevention / minimisation (as given in Sections 6.2 and 6.3).

The selection of the BAT for a specific case requires consideration of many different parameters. These are considered in detail in the horizontal WWWG BREF but the most important are:

- Gas flow rate (average value, range, rate of variation)
- Pollutant types and inlet concentrations (average value, range, rate of variation)
- Presence of impurities (e.g. water vapour, dust, corrosive substances)

- Concentration allowed in the exhaust
- Safety
- Investment & operating cost (minus credits for substance / energy recovery)
- Plant layout
- Availability of utilities

Depending on these parameters, Generic BAT for air pollutants from LVOC processes is an appropriate combination or selection of the techniques given in Table 6.1 (for VOCs) and Table 6.2 (for other air pollutants). In the case of high inlet concentrations of pollutants or less efficient recovery / abatement systems, a combination of techniques may be necessary to achieve the emission levels associated with BAT.

Technique	BAT-associated values ⁽¹⁾	Remark
Selective membrane separation	90 - >99.9 % recovery VOC < 20 mg/m ³	Indicative application range 1 - >10g VOC/m ³ Efficiency may be adversely affected by, for example, corrosive products, dusty gas or gas close to its dew point.
Condensation	Condensation: 50 - 98 % recovery + additional abatement. Cryo-condensation: ⁽²⁾ 95 - 99.95 % recovery	Indicative application range: flow 100 - >100000 m ³ /h, 50 - >100g VOC/m ³ . For cryo-condensation: flow 10 - 1000 m ³ /h, 200 - 1000 g VOC/m ³ , 20 mbar-6 bar
Adsorption ⁽²⁾	95 - 99.99 % recovery	Indicative application range for regenerative adsorption: flow 100 - >100000 m ³ /h, 0.01 - 10g VOC/m ³ , 1 - 20 atm. Non regenerative adsorption: flow 10 - >1000 m ³ /h, 0.01 - 1.2g VOC/m ³
Scrubber ⁽²⁾	95 - 99.9 % reduction	Indicative application range: flow 10 - 50000 m ³ /h, 0.3 - >5g VOC/m ³
Thermal incineration	95 - 99.9 % reduction VOC ⁽²⁾ < 1 - 20 mg/m ³	Indicative application range: flow 1000 - 100000m ³ /h, 0.2 - >10g VOC/m ³ . Range of 1 - 20 mg/m ³ is based on emission limits & measured values. The reduction efficiency of regenerative or recuperative thermal incinerators may be lower than 95 - 99 % but can achieve < 20 mg/Nm ³ .
Catalytic oxidation	95 - 99 % reduction VOC < 1 - 20 mg/m ³	Indicative application range: flow 10 - 100000 m ³ /h, 0.05 - 3 g VOC/m ³
Flaring	Elevated flares > 99 % Ground flares > 99.5 %	
3. Unless stated, concentrations relate to half hour / daily averages for reference conditions of dry exhaust gas at 0 °C, 101.3 kPa and an oxygen content of 3 vol% (11 vol% oxygen content in the case of catalytic / thermal oxidation).		
4. The technique has cross-media issues that require consideration.		

Table 6.1: BAT-associated values for the recovery / abatement of VOCs

Pollutant	Technique	BAT-associated values ⁽¹⁾	Remark
Particulates	Cyclone	Up to 95 % reduction	Strongly dependent on the particle size. Normally only BAT in combination with another technique (e.g. electrostatic precipitator, fabric filter).
	Electrostatic precipitator	5 – 15 mg/Nm ³ 99 – 99.9 % reduction	Based on use of the technique in different (non-LVOC) industrial sectors. Performance of is very dependent on particle properties.
	Fabric Filter	< 5 mg/Nm ³	
	Two stage dust filter	~ 1 mg/Nm ³	
	Ceramic filter	< 1 mg/Nm ³	
	Absolute Filter	< 0.1 mg/Nm ³	
	HEAF Filter	Droplets & aerosols up to 99 % reduction	
	Mist Filter	Dust & aerosols up to 99 % reduction	
Odour	Adsorption Biofilter	95 - 99 % reduction for odour and some VOC	Indicative application range: 10000 - 200000 ou/Nm ³
Sulphur dioxide & acid gases	Wet limestone scrubbing	90 – 97 % reduction SO ₂ < 50 mg/Nm ³	Indicative range of application for SO ₂ < 1000 mg/m ³ in the raw gas.
	Scrubbers	HCl ⁽²⁾ < 10 mg/Nm ³ HBr ⁽²⁾ < 5 mg/Nm ³	Concentrations based on Austrian permit limits.
	Semi Dry Sorbent Injection	SO ₂ < 100 mg/Nm ³ HCl < 10 - 20 mg/Nm ³ HF < 1 - 5 mg/Nm ³	Indicative range of application for SO ₂ < 1000 mg/m ³ in the raw gas.
Nitrogen oxides	SNCR	50 – 80 % NO _x reduction	
	SCR	85 to 95 % reduction NO _x < 50 mg/m ³ . Ammonia < 5 mg/m ³	May be higher where the waste gas contains a high hydrogen concentration.
Dioxins	Primary measures + adsorption 3-bed catalyst	< 0.1 ng TEQ/Nm ³	Generation of dioxins in the processes should be avoided as far as possible
Mercury	Adsorption	0.05 mg/Nm ³	0.01 mg/Nm ³ measured at Austrian waste incineration plant with activated carbon filter.
Ammonia & amines	Scrubber	< 1 – 10 mg/Nm ³	Acid scrubber
Hydrogen sulphide	Absorption (alkaline scrubber)	1 - 5 mg/Nm ³	Absorption of H ₂ S is 99 %+. An alternative is absorption in an ethanolamine scrubber followed by sulphur recovery.

3. Unless stated, concentrations relate to half hour / daily averages for reference conditions of dry exhaust gas at 0 °C, 101.3 kPa and an oxygen content of 3 vol%.

4. Daily mean value at standard conditions. The half hourly values are HCl < 30 mg/m³ and HBr < 10 mg/m³.

Table 6.2: BAT-associated values for the abatement of other LVOC air pollutants

There are potentially a large number and variety of substances that can be emitted to air from LVOC processes. These substances have widely different characteristics in terms of toxicity, global warming, photochemical ozone creation, stratospheric ozone depletion etc. The characteristics determine the level and type of BAT (i.e. substances with potential for high environmental harm warrant more onerous prevention and control).

In assessing the characteristics of substances a variety of classification systems are used. Unfortunately, although many Member States have their own systems, there is no air pollutant classification system that is universally used in Europe. The development of a common classification system would be a very large task and was beyond the scope of the LVOC information exchange.

The following BAT-associated levels have not been derived using the standard procedure used in other BREFs but are presented using the classification system that has been submitted by one Member State. In the case of Table 6.3 the NeR classification from the Netherlands is used since it contains BAT-associated levels consistent with a high level of environmental protection.

The NeR classification is just one example of good practice. The LVOC TWG recognise that there are other equally valid classification systems that can be used to establish BAT-associated levels for air emissions. Other classification systems are summarised in Annex VIII.

There are several points to note about the Dutch classification system:

- the classification is based on human toxicity and environmental impact, and also on the technical and financial ability to reduce the pollutant. Other factors (e.g. energy efficiency, global climate change) may have been considered in less detail
- the basis for the NeR classification is the German TA-Luft
- the classification system is periodically reviewed and details may change.

Categories **	Possible BAT solutions (not an exhaustive list)	BAT-associated emission level (mg/Nm ³) ***	Threshold (kg/h)
Extremely hazardous substances			
Dioxins & furans	Process integrated: good operating conditions and low chlorine in feedstock/fuel.	0.1 (ng I-TEQ/Nm ³)	no threshold
PCB's	End of pipe: Activated carbon, catalytic fabric filter, incinerator.	0.1**** (ng PCB -TEQ/Nm ³)	no threshold
Particulates			
Particulate matter	If filtration is not possible, up to 25 applies	10 – 25	≥ 0.5
	If filtration is not possible, up to 50 applies	10 - 50	< 0.5
Carcinogenic substances*			
∑ C1	Incinerator, scrubber, absolute filter, activated carbon.	0.1	0.0005
∑ C1 + C2		1.0	0.005
∑ C1 + C2 + C3		5.0	0.025
Organic substances (gas/vapour)*			
∑ gO1	Incinerator, (regenerative) activated carbon, vapour recovery unit.	20	0.1
∑ gO1 + gO2		100	2.0
∑ gO1+ gO2 + gO3		100 - 150	3.0
Organic substances (solid)*			
∑ sO1	If filtration is not possible, up to 25 applies	10 – 25	≥ 0.1
	If filtration is not possible, up to 50 applies	10 - 50	< 0.1
∑ sO1 + sO2	If filtration is not possible, up to 25 applies	10 – 25	≥ 0.5
	If filtration is not possible, up to 50 applies	10 - 50	< 0.5
∑ sO1 + sO2 + sO3	If filtration is not possible, up to 25 applies	10 – 25	≥ 0.5
	If filtration is not possible, up to 50 applies	10 - 50	< 0.5
Inorganic substances (gas/vapour)			
gI1	Many different solutions (e.g. chemical scrubber, alkaline scrubber, activated carbon)	1.0	0.01
gI2		5.0	0.05
gI3		30	0.3
gI4		Acid/alkaline scrubber, S(N)CR, lime injection.	200
Inorganic substances (solid)*			
∑ sI1	Fabric filter, Scrubber, Electrostatic precipitator	0.2	0.001
∑ sI1 + sI2		1.0	0.005
∑ sI1 + sI2 + sI3		5.0	0.025
* The summation rule applies (i.e. the given emission level applies to the sum of the substances in the relevant category plus those of the lower category).			
** Detailed substance classification is given in Annex VIII: Member State air pollutant classification systems.			
*** The emission level only applies when the mass threshold (of untreated emissions) is exceeded. Emission levels relate to half hourly averages at normal conditions (dry exhaust gas, 0°C and 101.3 kPa). Oxygen concentration is not defined in the NeR but is usually the actual oxygen concentration (for incinerators 11 vol% oxygen may be acceptable).			
**** Levels for PCBs are given here in terms of TEQ, for the relevant factors to calculate these levels, see article "Toxic Equivalency Factors (TEFs) for PCBs, PCDDs, PCDFs for Humans and Wildlife". "Van den Berg et al. Environmental Health Perspectives, Volume 106, No 12, December 1998"			

Table 6.3: Air emission levels associated with BAT for process vents in the LVOC industry

BAT for **flaring** is:

- minimise the need for hydrocarbon disposal to flare through good plant design (e.g. high integrity trip systems, flare gas recovery systems) and good plant management (e.g. skilled operators, appropriate maintenance)
- there is no BAT choice between ground flares or elevated flares because such decisions are made on the basis of safety
- BAT for elevated flare design and operation includes the provision of permanent pilots and pilot flame detection, efficient mixing (usually by steam injection), ratio controlled to the hydrocarbon flow, and remote monitoring by Closed Circuit Television (CCTV)
- destruction efficiency of > 99% for elevated flares and > 99.5% for ground flares.

BAT for **process furnaces** is gas firing and low-NO_x burner configuration. This can achieve NO_x reduction down to 50 - 100 mg/Nm³ (as an hourly average) for new and existing situations. Values towards the higher part of the range indicate the adverse effect of high temperatures (air preheat) and hydrogen-rich fuels. In exceptional situations, with little possibilities for retrofit, emissions up to 200 mg/Nm³ may occasionally represent BAT.

The BAT for **other combustion units** (e.g. steam boilers, gas turbines) can be found in the BREF on Large Combustion Plant [EIPPCB, Draft #127].

Emissions of carbon dioxide are directly related to energy consumption and the carbon content of the fuels used. BAT for **carbon dioxide emissions** is improved energy efficiency, but a switch to low-carbon (hydrogen-rich) fuels or sustainable non-fossil fuels may also be considered BAT.

6.5 Water pollutant control

The following BAT for water pollutants presume the optimisation of BAT for environmental management and prevention / minimisation (as given in Sections 6.2 and 6.3). BAT for water pollutants is:

- Waste water streams containing heavy metals or toxic or non-biodegradable organic compounds (e.g. indicated by high COD/BOD ratios) are treated or recovered separately. Individual waste streams containing toxic or inhibitory organic compounds or having low bio-degradability are treated separately e.g. by (chemical) oxidation, adsorption, filtration, extraction, (steam) stripping, hydrolysis (to improve bio-degradability) or anaerobic pre-treatment. Effluent from individually treated waste streams are discharged to a combined biological treatment plant for further treatment. In particular metals and heavy metals are treated as individual waste streams before mixing with non-metal containing streams. BAT-associated emission values (as daily averages) in individual waste streams are:

Hg:	0.05 mg/l
Cd:	0.2 mg/l
Cu, Cr, Ni, Pb:	0.5 mg/l
Zn, Sn:	2 mg/l

- Organic waste water streams not containing heavy metals or toxic or non-biodegradable organic compounds are potentially fit for combined biological waste water treatment (subject to an evaluation of biodegradability, inhibitory effects, sludge deterioration effects, volatility and residual pollutant levels in the effluent).

In general, combined biological treatment can achieve an effluent BOD of < 20 mg/l (as a daily average). A typical design for this treatment plant is a lowly loaded biological treatment plant, which in the case of an activated sludge plant is a COD load of ≤ 0.25 kg COD/kg sludge (as dry solids) / day.

It is difficult to describe achievable emission levels that are applicable for all LVOC processes as the waste water characteristics are strongly influenced by, *inter alia*, the applied processes, operational process variability, water consumption, source control measures and the extent of pre-treatment. Nevertheless, based on the expert judgement of the TWG, the following emission levels are associated with the use of BAT:

Parameter	BAT-associated values (as daily averages)
COD	30 – 125 mg/l ⁽¹⁾
AOX	< 1 mg/l ⁽²⁾
Total nitrogen	10 - 25 mg/l ⁽³⁾
<p>(1) The lower end of this range is determined by values of 30 – 45 mg/l for Lower Olefin effluents. Lower Olefin data has been extrapolated from TOC data and may also have been back-calculated from the percentage contribution to a central WWTP.</p> <p>(2) Most LVOC processes can achieve an AOX value below 1 mg/l. In a few specific cases, such as the chlorohydrin process, a range of 1- 5 mg/l AOX is achievable. CEFIC assert that there is inadequate experience in the use of AOX and it is not possible to derive a BAT-associated level. If EOX is used as alternative for AOX, it should be noted that the analytical methods focus on different groups of halogenated hydrocarbons and that no universal correlation exist between AOX and EOX, except that AOX >or >> EOX.</p> <p>(3) The exact figure largely depends on the applied processes and type of biological treatment system (N-removal).</p>	

Table 6.4: BAT-associated values for water emissions

6.6 Wastes and residues control

The following BAT for wastes and residues pollutants presume the optimisation of BAT for environmental management and prevention / minimisation (as given in Sections 6.2 and 6.3).

- BAT for **catalysts** is regeneration / re-use and, when spent, to recover the precious metal content with landfilling of the catalyst support.
- BAT for **spent purification media** is, where possible, to regenerate, and if not to landfill or incinerate under appropriate conditions.
- BAT for **organic process residues** is, where possible, to maximise their use as feedstock or as fuel, and if not to incinerate under appropriate conditions.
- BAT for **spent reagents** is, where possible, to maximise their recovery or use as fuel, and if not to incinerate under appropriate conditions.

7 ILLUSTRATIVE PROCESS: LOWER OLEFINS

The lower olefins sub-sector is illustrated by the cracking process. The world-wide demand for lower olefins (ethylene, propylene, butenes and butadienes) is higher than any other chemical, but due to their high reactivity they are only found in very low concentrations in crude oil. It is therefore necessary to 'crack' saturated hydrocarbons into unsaturated hydrocarbons using the large-scale catalytic cracking or steam cracking processes.

7.1 General information

The Lower Olefins are a very important group of substances for the chemical industry and they are the primary feedstock for most plastics, polymers and man-made fibres. Olefins derivatives are to be found in clothing, household fabrics, carpets, cooking utensils, vehicle components, aircraft, computers, paints, solvents, cosmetics and pharmaceuticals.

Ethylene is a very important building block for the organic chemical industry and its range of derivatives is shown in Figure 7.1. More than 50 % of ethylene is used in the production of polyethylene, but it is also particularly important in the production of polystyrene (via ethylbenzene and styrene), glycol (via ethylene oxide), vinyl acetate (via acetaldehyde and acetic acid) and PVC (via 1-2 dichloroethane and vinylchloride).

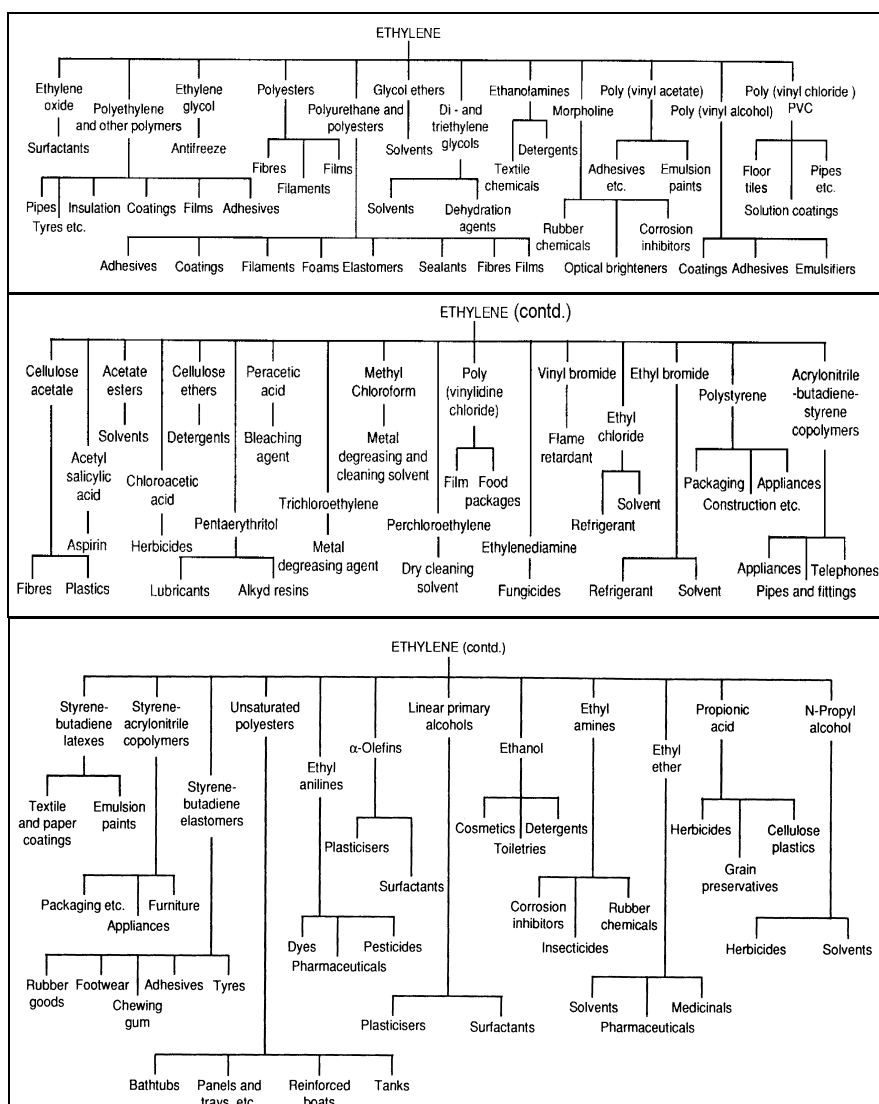

Figure 7.1: Uses of ethylene

[EC DGXI, 1993 #8]

More than 50 % of **propylene** is used to produce polypropylene. Other important products include acrylic esters (via acrylic acid), phenol and acetone (via cumene), acrylonitrile fibres, butanol and ethylhexanol (via butyraldehyde), and glycol (via propylene oxide).

Some 47 % of **butadiene** is used to produce styrene/butadiene rubbers and latexes. A further 27 % is used for producing polybutadiene rubber, most notably EPDM (ethylene-propylene-diene monomer) rubber that is made via 1,4 hexadiene. It is also used for the production of adiponitrile – a precursor for nylon production.

7.1.1 Production capacity

The total nameplate production capacity of **ethylene** in European Union Member States is 20 million tonnes per year and this accounts for some 25 % of world supply. European ethylene production capacity has expanded by 5 million tonnes in the last 10 years, but only four new crackers were built during the period. The capacity increase has been largely achieved through the expansion and optimisation of existing plants, and this is reflected in the capacity utilisation of 93 % [CEFIC APPE, 1998 #15]. Within the European Member States there are 50 crackers and these are located on 39 different sites (see Table 7.1).

Propylene capacity in Western Europe was 14.5 million tonnes in 1997, with an actual production of 12.6 million tonnes. Around 9.6 million tonnes was produced on steam crackers, with the balance being recovered from refinery streams. Generally, the growth of propylene derivatives has exceeded that of ethylene, resulting in a propylene market growth of 4.5 % per year in the last 10 years. The annual production of **butadiene** in Western Europe is 2 million tonnes and this represents a capacity utilisation of 85 %.

Over the next 5 years, ethylene is forecast to grow at around 2.4 % per year, with propylene demand predicted to increase at 3.9 % per year. This would lead to an imbalance between supply and demand for the two products, resulting in a possible shortfall in propylene supply.

7.1.2 Feedstocks

In Western Europe, liquid naphtha (from crude oil refining) is by far the most important raw material and accounts for 73 % of ethylene production. Other feedstocks are less significant in Western Europe, but ethylene is also produced from gas-oil (10 %), butane (6 %), ethane (5 %), propane (4 %) and other sources (2 %).

Liquid feeds predominate in Europe because they are relatively abundant and easy to transport. It is not essential to co-locate ethylene plants with a suitable source of feed and it is often an advantage to integrate with derivative plants since the total demand chain plays a critical part in the overall value of the business. Gas oil cracking may be undertaken where plants are located adjacent to and integrated with refineries.

Gas feedstocks are less used in Europe because they are rarely economically available. Ethane is extracted from natural gas by cryogenic liquefaction, and there are few locations in Europe where gas is sufficiently concentrated to allow economic recovery (e.g. with access to pipeline supplies from North Sea production fields). Ethane is also difficult to transport as it requires special refrigerated ships or high pressure pipeline systems. Some European plants have a degree of flexibility to process LPG (Liquefied Petroleum Gas), but this is limited by the different physical configurations of ‘gas’ and ‘liquid’ fed crackers.

In the USA, particularly on the Gulf Coast, most crackers use gas feedstocks rather than naphtha and enjoy both lower capital and operating costs. This advantage may be eroded by low oil prices and the increasing value of co-products, in particular propylene. USA labour and utility costs are also lower than in Europe, and there is a more established pipeline infrastructure allowing virtual ‘freight-free’ movement of olefins to the derivative plants.

Country	Location	Operator	Number of crackers	Capacity (kt/yr ethylene)
Austria	Schwechat	OMV	1	345
Belgium	Antwerp	FAO	3	1050
	Antwerp	BASF	1	670
The Netherlands	Geleen	DSM	2	1100
	Moerdijk	Shell	1	650
	Terneuzen	Dow	2	1100
Finland	Kulloo	Borealis	1	290
France	Berre	Montell/Elenac	1	420
	Carling	Elf Atochem	2	480
	Dunkerque	Copenor	1	350
	Feyzin	AP Feyzin	1	240
	Gonfreville	Elf Atochem	1	480
	Lacq	Elf Atochem	1	75
	Lavera	Naphtachimie	1	700
	ND Gravenchon	Exxon	1	400
Germany	Böhlen	BSL	1	464
	Burghausen	OMV	1	310
	Gelsenkirchen	Veba Oel	2	880
	Heide	RWE-DEA	1	86
	Köln-Worringen	Erdoelchemie	2	780
	Ludwigshafen	BASF	2	560
	Munchmunster	Veba Oel	1	280
	Wesseling	Elenac	2	860
	Wesseling	RWE-DEA	2	480
Greece	Thessaloniki	EKA	1	20 ⁽³⁾
Italy	Brindisi	Polimeri Europa	1	360 ⁽¹⁾
	Gela	Enichem	1	250
	Priolo	Enichem	1	740
	Porto Marghera	Enichem	1	460
	Porto Torres	Enichem	1	250
Portugal	Sines	Borealis	1	340
Spain	Puertollano	Repsol	1	280
	Tarragona	Repsol	1	600
	Tarragona	Dow	1	530
Sweden	Stenungsund	Borealis	1	405 ⁽²⁾
UK	Fawley	Exxon	1	120
	Grangemouth	BP Amoco	2	700
	Mossmorran	Exxon/Shell	1	720
	Wilton	Huntsman/ICI	1	865
TOTAL EU			50	19690
Norway			1	410
Switzerland			1	25
TOTAL WESTERN EUROPE			52	20125
Bulgaria			2	450
Croatia			1	70
Czech Republic			1	400
Hungary			1	300
Poland			1	360
Romania			1	200
Slovakia			1	200
Yugoslavia			1	200
TOTAL APPE AFFILIATES			61	22305

Note 1: Year 2000 capacity is 410 kpta [Federchimica, 2000 #123]
Note 2: Year 2000 capacity is 610 kpta.
Note 3: Ethylene plant of the Hellenic Petroleum Company was closed in 2000.

Table 7.1: Location of ethylene plants in the European Union and wider Europe [CEFC APPE, 1998 #15]

7.1.3 Economic factors

The European petrochemical industry accounts for 28 % of world turnover and olefin-based products form a significant proportion of this activity. It is one of the most important manufacturing sectors in the EU and has an estimated market capitalisation exceeding 15 billion Euro. The European Petrochemical industry directly employs around 20000 people, and production of the principal derivative products (plastics and polymers) employs a further 70000 people in Europe. The wider industry chain, including machine manufacturers and converters, is estimated to employ 1.1 million people [CEFIC, 1999 #43].

In recent years, the chemical industry in general has been the subject of major restructuring, resulting in increased segmental focus in areas such as specialities, life sciences, inorganics, and base chemicals. For lower olefins, despite some realignment of assets, only four new steam crackers have been built in the last decade, and more than 50 % of plants currently in operation are more than 25 years old. This position stems directly from the large investment costs for new plants, and the low margins in olefin production.

Markets. Lower Olefins are sold on chemical specification rather than their performance and so competition is geared heavily towards price. This promotes international trade but makes Europe potentially vulnerable to imports from sources using cheaper feedstocks (particularly gas) or where operating costs are lower. Producers in the USA, the Middle East and Asia are able to access at least one of these advantages and can therefore compete aggressively against European manufacturers. Whilst transportation costs for olefins are relatively high, those for first-derivative polymers are very low, making it attractive to import polymer product into Europe from anywhere in the world. In real terms, the cost of these products continues to fall as new producers compete for market share [CEFIC, 1999 #43]. Constant pressure is therefore exerted on the transfer price of olefins, and in order to remain competitive, producers must look to ways of reducing operating cost margins. In the absence of technological breakthrough, this can only be achieved by continuous operating cost improvements, often involving investment in new plant and equipment, and by ongoing pruning of the operating fixed costs.

Compared with other chemical sectors, lower olefins is characterised by an unusually high number of separate producers and this partly reflects the strategic desire of each country to have its own ethylene production source. No single company dominates the market in Europe, although there are a number of co-operative alliances and a number of long-distance ethylene pipelines across Europe that link otherwise remote producers and users. There may be sector rationalisation in the future because of the large number of producers and low profit margins.

Investment costs. Steam crackers are very large complex plants that involve significant investment costs. All crackers incorporate proprietary designs that are licensed from a small number of technology contractors in the USA and Europe. At a global level no more than 4 - 6 new crackers are announced in a year and this forces intense competition between contractors. Investment costs vary from region to region, influenced by the cost of construction labour, and the proximity to a developed infrastructure. In real terms, investment costs have fallen over the last decade because of increased scale, enhanced design and improved project execution. Table 7.2 shows investment costs for a world scale plant (600 kt/yr ethylene) built on a European green-field site.

Feedstock	Investment Cost (M Euro)	Unit Cost (Euro per tonne ethylene)
Ethane	540 - 600	900 - 1000
Naphtha	660 - 780	1100 - 1300
Gas-oil	720 - 850	1200 - 1400

Table 7.2: Ethylene plant investment costs for different feedstocks
[CEFIC, 1999 #43]

At average cracker margins, investment in a green-field plant in Europe cannot return the capital costs. Investors therefore seek to capture other sources of value to achieve acceptable returns [CEFIC, 1999 #43] and this might involve:

- access to lower cost gas feedstocks (this is restricted to coastal locations, and is only viable when the gas can be considered to be 'distressed')
- co-location with other production units (to reduce overheads by sharing common services)
- investment in 'brown-field' sites (where infrastructure already exists).

It is not possible to derive generic investment costs for brown-field sites since the scope of work is location specific. The 'core' cost of a cracker (usually referred to as ISBL - inside battery limits) might account for 60 - 65 % of the total green-field plant cost. Other costs will be incurred, such as increased provision for utility systems, but will depend on the amount of free space available in existing systems. The investment costs for the expansion of existing plants are even more difficult to define since there is need to consider factors of accessibility, physical plant layout and modifications to existing equipment. Furthermore, the commercial justification for an expansion is determined by unique factors (e.g. increased on-site product demand)

Production costs. The production costs of any process include variable costs (which are largely dependent on throughput), and fixed costs (such as operating labour, maintenance, and site overheads). To the cash cost 'ex-works' must be added the costs of freighting to the purchaser and of technical service and sales. The cash costs for lower olefins are shown in Table 7.3 for West European leader plants in 1997. The cost of feedstock accounts for most of the variable cost and therefore causes most of the cost fluctuation.

	Butadiene	Ethylene
Capacity (Kt/yr)	90	620
Total Capital – replacement cost (£ million)	45	393
Net Variable Costs (including credit for by-products) (£/t)	146	107
Total Fixed Costs (£/t)	27	30
	CASH COST (£/t)	
	173	137
Freight (£/t)	24	12

Table 7.3: Cash costs of production for Lower Olefins - West European leader plants
[Environment Agency (E&W), 1998 #1]

Price Sensitivity. The prices of products and feedstocks are highly cyclical (Figure 7.2). The price of naphtha has fluctuated by 93 % over the period 1993 - 98 and this has resulted in product price fluctuations ranging from 63 % (for butadiene) to 104 % (for propylene).

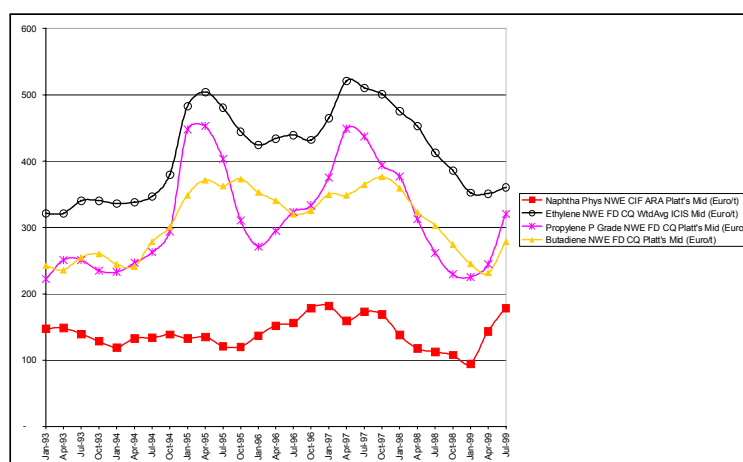

Figure 7.2: Price fluctuations of Lower Olefin feedstock and products
[CEFIC, 1999 #43]

Profitability. The profit element (margin) of an installation can be determined by its position on the production cost curve for the total industry. The price of product is determined by production costs in the least competitive plants. The cash cost curve for ethylene in Western Europe (Figure 7.3) has a shape that represents not only the different plant efficiencies and scale, but also different feedstock sources.

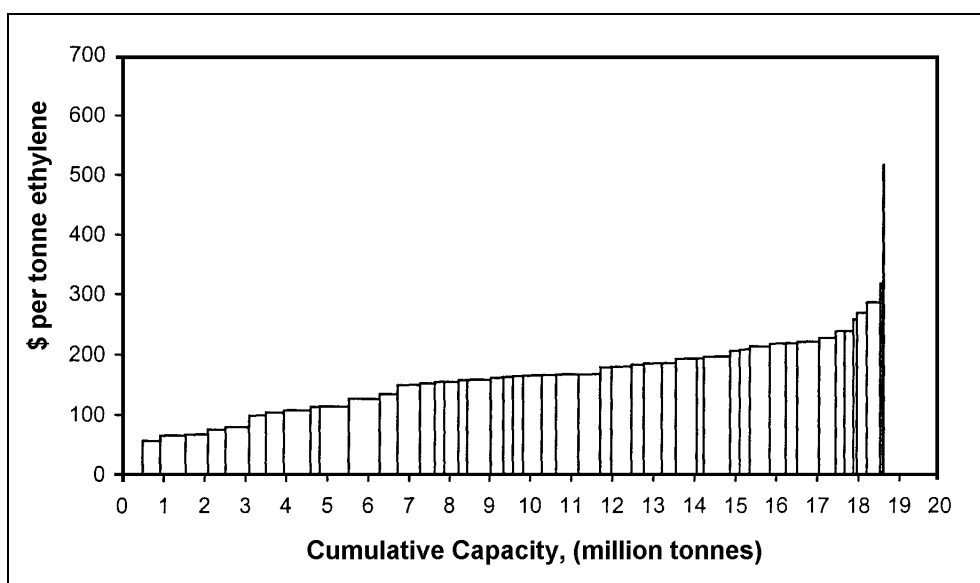

Figure 7.3: Production costs curve for ethylene
[Environment Agency (E&W), 1998 #1]

The steepness of the cash cost curve is an indicator of the potential for a competitive producer to make profit. A simple indicator of the steepness of the cash cost curve is the difference between the cash costs of leader and laggard plants (broadly, the best 20 percent and the worst 20 percent of the regional cost curve). The difference between the best (leader) and worst (laggard) performing plants in Europe is estimated to result in a range of costs from £137 / tonne to £198 / tonne [Environment Agency (E&W), 1998 #1]. The difference (£61 / tonne) appears to indicate a healthy industrial sector, but more detailed analysis suggests that when discounts and other factors are taken into account, the return on investment (ROI) in Europe has been below the cost of capital at around 7 % [CEFIC, 1999 #43].

Given that projects are usually only sanctioned when returns exceed a minimum capital charge of around 16.25 % per year (equivalent to 10 % per year for 10 years) it is unsurprising that few new crackers have been built in the last decade. Instead, producers have chosen to maintain their competitive position by extending the life of existing plants with investments in increased capacity and upgraded equipment. Some 75 % of new capacity brought on-stream in the last 10 years has been achieved through expansion projects, rather than in new facilities. This policy has made sound economic sense for a highly cyclical commodity business in which the capital cost of new plant is very large and the returns uncertain.

The histories of cash cost margins for ethylene and butadiene are shown in Figure 7.4 for West European leader plants. The margins fluctuate widely, largely synchronised with the industry business cycle. This indicates that changes in costs cannot be passed on to consumers. Both buyers and sellers are well informed in these markets and will press for the benefits of over-supply or under-supply respectively.

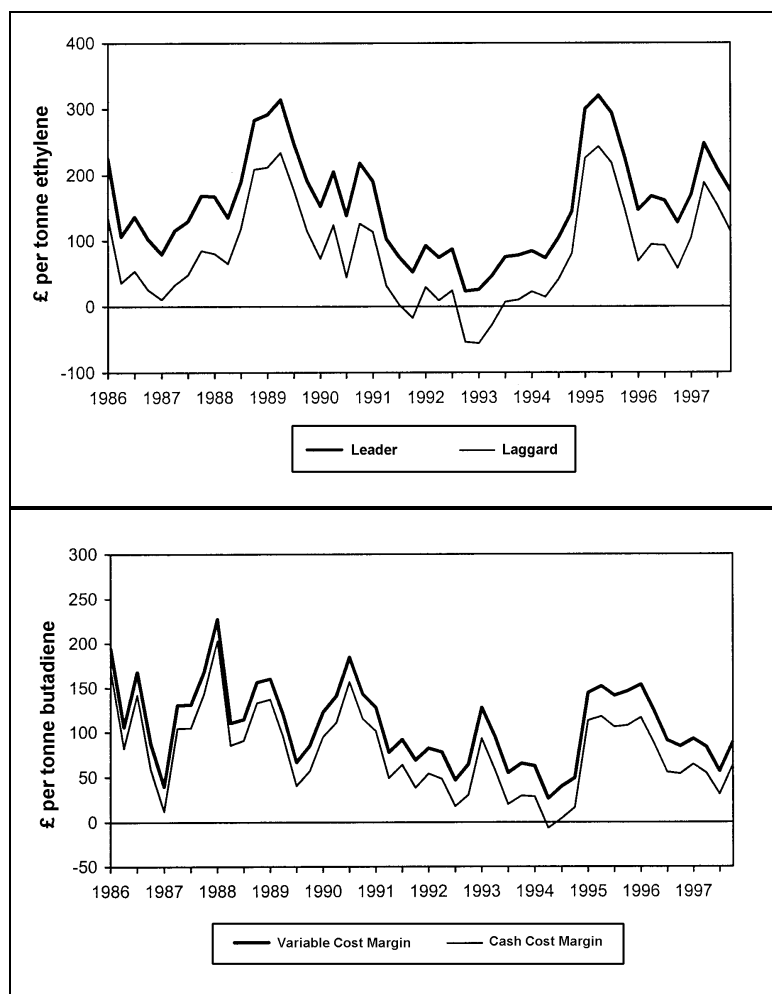

Figure 7.4: Ethylene and butadiene production costs trend
[Environment Agency (E&W), 1998 #1]

Investment. Ethylene manufacture via the steam cracking process is a mature technology that has been the industry standard for almost 50 years. The process continues to be improved by both manufacturing and engineering technology companies, notably in the development of furnace design where new materials and enhanced coil configuration has led to a significant improvement in conversion and selectivity to the desired products. In addition, improvements in the efficiency of machinery and distillation column internals have allowed greater throughput with the same major equipment items. Investment in new plant is normally justified over a life of at least 20 years, although the life expectancy of major process equipment varies considerably. Due to the severe operating regime in the cracking section some components need replacement several times in this period, whereas much equipment in the non-corrosive internal environment of the recovery section has a life expectancy in excess of 50 years.

Whatever the investment option being considered, it is necessary to take account of the full cycle of profit margins (historically around 7 years). This cycle is extremely difficult to break, since it relates to the time taken to bring new capacity on line, and the availability of investment funds. Ideally, manufacturers wish to invest close to the bottom of the cycle, so that the new capacity comes on-stream 3 or 4 years later and captures the maximum margins for the first critical years of production. In practice, reduced cash flow at the bottom of the cycle severely limits the availability of re-investment capital, and typically causes investment decisions to be deferred to periods when margins are greater. This results in the new capacity coming on stream at the worst possible time (at the bottom of the cycle) contributing to the depressed margins [CEFIC, 1999 #43].

The justification for capital investment in environmental improvement also needs to recognise the average margins achieved over many years. It has been reported [Environment Agency (E&W), 1998 #1] that the affordable cost for environmental improvement, averaged over the cycle, may be of the order of 1.5 to 15 Euro/tonne ethylene. Investment at the upper end of the range may cause some companies financial loss during periods of negative cash flow. It may also be difficult to pass new costs onto customers as ethylene shows price in-elasticity.

It is difficult to establish generic investment costs for environmental improvement plant because they are so dependent on the local factors such as available space, and ease of access. The investment costs of environmental improvements may be several times more on an existing process when compared with incorporating the same enhancement into a new plant. This may be a restriction to the retrofitting of BAT standards to existing installations and underlines the importance of adopting BAT at the time of new cracker construction.

Data sources. The Lower Olefins industry has well-established systems for sharing a variety of economic data that helps optimise production cycles in this highly integrated industry. The American consultants Solomon Associates provide a comprehensive international review of crackers through a biennial report based on questionnaire responses from co-operating producers. Other economic reviews are CMAI's monthly 'European marker report on olefins' and *ad hoc* studies by Chemsystems. The Association of Petrochemicals Producers in Europe (APPE) is part of CEFIC and collates a variety of data in its role of representing the interests of Lower Olefin producers.

7.2 Applied processes and techniques

Cracking is the process by which saturated hydrocarbons are converted into more sought after unsaturated species. This is a dehydrogenation reaction that can be effected either catalytically or thermally. In Western Europe, the steam cracking process accounts for more than 95 % of ethylene and butadiene production, and 75 % of propylene production [CEFIC, 1999 #43]. Propylene is also recovered from refining operations, in particular from Fluidised Catalytic Cracker off-gas, and through the dehydrogenation of propane.

7.2.1 Catalytic cracking

Catalytic cracking is used in refineries to convert the heavy (higher boiling) fractions into saturated, branched paraffins, naphthenes (cyclo-paraffins) and aromatics. Refineries typically achieve this using a fluidised bed (Fluidised Catalytic Cracking – FCC) or a cracker with rising catalyst (Riser Cracking). Most of the products are liquids and this method is most useful for the preparation of fuels. The concentration of olefins in the product stream is very low and ethylene recovery is generally unattractive due to process economics. Where recovery is undertaken, it is invariably through the processing stages of a co-located steam cracker. The catalytic cracking process is addressed in the BREF on Refineries.

7.2.2 Steam cracking

Almost the entire world demand for ethylene and butadiene, and the majority of propylene, is produced using the steam cracking process. In this process, suitable hydrocarbons are heated to very high temperatures, in the presence of steam, to split or 'crack' the molecules into the desired lower olefin products.

Unlike much of the chemical industry, a small number of international technology contractors licence the equipment employed on crackers. These specialist contractors utilise similar generic designs, but with modifications that optimise the plant performance to local conditions (especially with respect to integrated energy efficiency). Most proprietary designs concern the

furnace, but there may also be variations in the pressure and temperature of the fractionation columns; refrigeration systems (open versus closed loop); and the use of turbo expanders. Manufacturers are not tied to one particular technology contractor, and it is normal to find a cracker retro-fitted with equipment from rival contractors.

Regardless of contractor or feedstock, a cracker can be broken down into three separate sections: pyrolysis; primary fractionation / compression; and product fractionation (Figure 7.5).

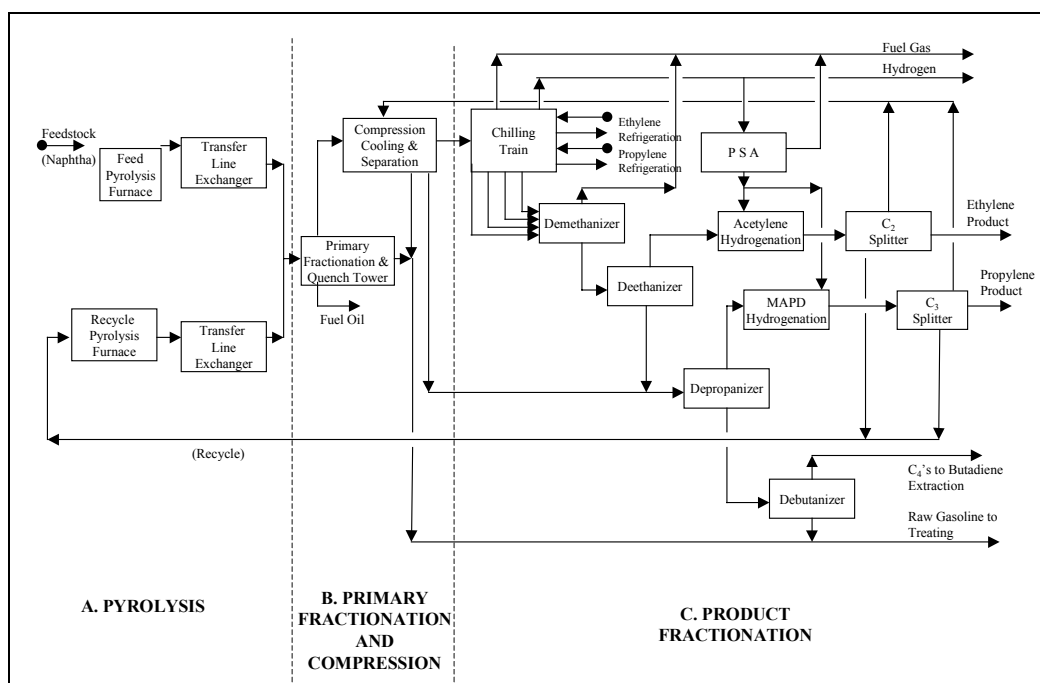

Figure 7.5: Typical block flow diagram for a front-end de-methaniser sequence [CEFIC, 1999 #54]

7.2.2.1 Pyrolysis section

The hydrocarbon feedstock is preheated in heat exchangers and then vaporised with superheated steam before passing into tubes arranged in a **cracking furnace** (see Figure 7.6). The tubes are long (50 - 200 metres) and of narrow bore (25 - 125 mm), and normally made of chromium nickel. The tubes are externally heated to 750 - 875 °C by oil or gas fired burners. By controlling the residence time, temperature profile and partial pressure, the hydrocarbon feedstock is cracked into smaller molecules (mainly ethylene, propylene, other mono-olefins and di-olefins). The conversion of saturated hydrocarbons to unsaturated compounds is highly endothermic and therefore requires a high-energy input. Steam is injected to reduce the partial pressure of the hydrocarbon mixture and also to minimise coke formation. Very small amounts of dimethyldisulphide (DMDS), or other sulphur containing additives, may also be added to minimise the formation of coke and carbon monoxide.

The **transfer line exchangers** (TLEs) are used to quickly quench the product gases to 550 - 650 °C (to prevent degradation by secondary reactions) and to generate high-pressure steam for plant re-use. Gas feedstocks usually have secondary TLEs to maximise the heat recovery. Crackers using heavy liquid feed (gas-oil or vacuum gas-oil) do not generally use TLE's, because of the risk of coking, and instead use direct oil quenching.

Furnace tubes and TLEs are prone to coking on their internal surfaces. Depending upon the design basis and feedstock, on-line, steam-air decoking of the furnace tubes and TLEs may allow run lengths of up to 120 days, occasionally longer, before there is a need for high pressure water washing or mechanical decoking (if required at all).

7.2.2.2 Primary fractionation and compression

The **primary fractionation and compression section** consists of the primary fractionator (naphtha and gas oil feed only), quench tower, gas compressor and gas cleanup facilities. The latter may include an amine unit or caustic unit and drying facilities. The primary fractionator is used to condense out and fractionate fuel oil streams produced from naphtha and gas oil fed crackers. The gases are de-superheated in the quench tower by a circulating oil or water stream. The circulating oil or water stream is used as a medium level heat source for the rest of the plant. Some plants have no quench water tower and use direct cooling of the cracked gas with air coolers and/or cooling water. Tarry bottoms are removed from the system as product, which mostly fuels non-steam cracking furnaces and boilers. Most of the dilution steam is condensed. Dilution steam is generally recovered and recycled back to the front end of the plant. During the start-up of the recovery and fractionation areas gases may be flared whilst the correct operating conditions are established and gas recycles may be used to reduce the need for flaring.

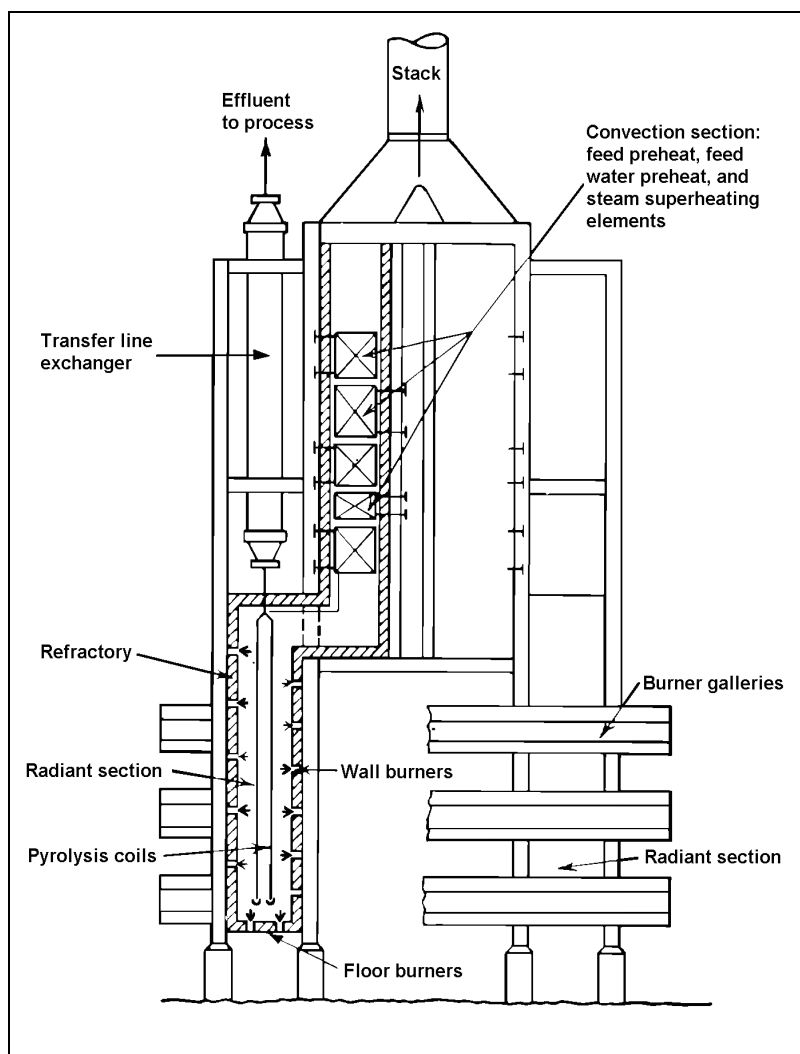

Figure 7.6: Typical cracking furnace configuration
[CEFIC, 1999 #54]

Gas compression. Product gases from the quench tower are condensed by four or five stages of gas compression. The gas is cooled after each stage and passed through a liquid knock-out drum. Large centrifugal compressors are used and are usually driven by high-pressure condensing steam turbines, or occasionally by electric motors.

Gas Cleanup. Some naphtha and gas-oil feeds may contain up to 10000 ppm (1 %) of sulphur although most have typical levels of 100 ppm or less. Gas feedstock has a general requirement for acid gas removal upstream of the cracker and is therefore virtually sulphur-free as cracker feed. Sulphur is, however, a well known inhibitor of catalytic coke formation, and most operators inject sulphur, either in the dilution steam or hydrocarbon feed steam, to give a sulphur level in the furnace feed of around 50 - 100 ppm.

There is a need to remove acid gases and carbon dioxide (produced at levels of a few hundred parts per million in the cracking process) from the cracked gas (ethylene and propylene products). Carbon dioxide may form solid deposits in the cryogenic sections of the plant and is an unacceptable impurity in the final ethylene product.

The acid gas removal systems are designed to reduce the concentration of carbon dioxide and sulphur compounds in the cracked gas to less than one ppm. Acid gas removal involves a caustic unit (sometimes in combination with amines) and this generates an effluent that requires treatment. Gasoline may also be injected into the caustic scrubber to reduce polymer formation and to dissolve any that is present. Carbon dioxide can be removed by absorption in monoethanolamine (MEA). Drying, typically in molecular sieves, is also required after the final compression stage because the cryogenic temperatures in the downstream fractionation equipment would cause ice formation.

7.2.2.3 Product fractionation

The **chilling train** usually consists of four or five successive stages of chilling, incorporating ethylene and propylene refrigeration, as well as an elaborate self-refrigeration system. This produces hydrogen that is used for downstream hydrogenation, hydrotreating of the heavier products (e.g. fuel oil) and as a saleable product. In some processes, C_2 acetylene is hydrogenated in the cracked gas, prior to de-methanation. The methane stream from the chilling unit is used as fuel gas, mostly internally in the plant's furnaces and boilers.

The exact process flow sequence varies according to the feedstock and the design arrangement, but various **fractionation towers** are used to separate the desired products. This may include a sequence of de-methaniser (to further remove methane), followed by a de-ethaniser (to remove ethane, ethylene and a small quantity of acetylene). Bottoms from the de-ethaniser are directed to the de-propaniser and then to a de-butaniser. The lighter the feedstock, the less need for the later separation systems.

After separation, the ethylene still contains undesirable acetylene and ethane. Acetylene is either removed by selective **catalytic hydrogenation** or by **extractive distillation**. The separation of ethylene and ethane requires a particularly effective column due to the close proximity of their boiling points. The ethane component may be recycled back to the cracker for re-working. Similarly, the C_3 fraction still contains methyl acetylene and propadiene after separation. Selective hydrogenation is used to convert this into propylene and propane prior to separation in a C_3 splitter.

7.2.3 Feedstock considerations

The ideal feedstocks for the production of ethylene by steam cracking are straight-chain normal paraffins (C_nH_{2n+2}), where n is typically in the range 2 to 12. Apart from ethane (C_2) and propane (C_3), it is unusual to find pure component feeds. The butanes (C_4) are more often found

as a mixture of the normal and iso-butane isomers, whilst for C₅ and above the number of isomers increases significantly. Most producers are therefore obliged to crack mixtures of feedstocks that are either gaseous (ethane, propane, and sometimes butane) or liquid (light, medium, heavy, full range naphtha, natural gas condensates, butane and gas oil).

Different feedstocks produce different ethylene yields and ranges of products. Generally, as the molecular weight of a feedstock increases, the yield of ethylene decreases and other products (e.g. propylene, butadiene and benzene) are produced in recoverable quantities (although the separation and purification of these co-products adds complexity and cost to the process). Heavier petroleum fractions are also subject to more side reactions that produce tarry products and contain coke precursors. The full range of product yields (for one pass through the furnace) are shown in Table 7.4.

Product	Feedstock				
	Ethane	Propane	Butane	Naphtha	Gas-oil
Hydrogen	4.3	1.3	1.2	0.8	0.5
Methane	4.2	25.2	20.1	13.5	10.9
Acetylene	0.4	0.5	0.8	0.7	0.2
Ethylene	56	40.9	40.4	28.4	20.6
Ethane	30	3.6	3.5	3.9	4.8
Propadiene	0.1	0.5	1.2	0.4	0.5
Propylene	1	11.5	14.4	16.5	14
Propane	0.2	5	0.1	0.5	0.8
Butadiene	1.6	4.5	4.3	4.9	4.9
Butylenes	0.2	1	1.3	5.2	3.9
Butane	0.2	0.1	2	1	0.1
C ₅ /C ₆	1.8	5.9	10.7	3.9	1.9
C ₇ + non-aromatics				1.2	2.1
Aromatics				10.5	12.5
< 430 °C				5.2	2.6
> 430 °C				3.4	19.7
Total	100	100	100	100	100

Table 7.4: Product yields (as %) for different feedstocks [CEFIC, 1999 #54]

A large proportion of Europe's propylene demand (and all of the butadiene demand) can be satisfied by the steam cracking of naphtha and gas-oil. The balance of propylene demand is essentially supplied from extraction of propylene from refinery Fluidised Catalytic Cracker off-gas and imports. There is one PDH (propane dehydrogenation) plant in Europe, but it is only economic when propane prices are low. A similar process for butadiene production (by the dehydrogenation of n-butane) is also available but is not used in Europe where there is generally a surplus of butadiene from steam cracking.

Even for a set feedstock, there is some flexibility within the cracking process to adjust the relative yields of the products. If the value of propylene increases (relative to ethylene), then the production ratio of propylene to ethylene can also be increased (within narrow constraints) by reducing the cracking 'severity'.

Whilst the steam cracking process is broadly similar throughout Europe, each plant has a different economic optimum configuration for the producer. No feedstock can therefore be described as optimal for the production of olefins since supply-demand economics drive the relative cost of the feeds, and the value of co-products. This is shown during the summer months when seasonal effects reduce the cost of LPG (relative to naphtha) and it becomes economic to crack fairly significant quantities of LPG (propane and butane). Different feedstocks necessitate subtle differences in equipment and operating regime to the cracking Unit Process, and these are outlined below.

7.2.3.1 Gas

Lower olefins are often produced from gaseous feeds of ethane or propane, or, to a much lesser extent, n-butane. The cracking of ethane produces ethylene and only small quantities of products that are heavier than C₃. Ethane gives the best ethylene yield (one tonne of ethylene is produced from 1.25 tonnes of ethane) and by contrast, 2.17 tonnes of propane or 2.3 tonnes of butane are required to produce one tonne of ethylene. Field butane (a mixture of n-butane and iso-butane) can also be used as gas cracker feedstock and the iso-butane has an excellent propylene yield.

In Europe, there has been limited access to gas feedstocks and few plants are designed for their exclusive use. However, changes to the regulations on motor gasoline volatility have required a reduction in the quantity of butanes that refiners may blend into gasoline during summer months and this has resulted in increased butane cracking.

The gas-cracking process does not change for moderate amounts of n-butane in the feed (up to 25 % v/v), but higher butane concentrations require facilities that are more similar to a naphtha cracker. In a fractionation scheme with a front-end de-methaniser, gas and dilution steam (with a steam / hydrocarbon weight ratio of 0.3) are heated to a cracking temperature of 840 - 860 °C in tubular furnaces. The cracked hydrocarbon components flow forward into the compression system and exit with the high-pressure cracked gas. Compression is usually carried in 4 to 6 stages for ethane.

Ethane crackers are frequently operated without a de-butaniser and heavier products are used as fuel or in gasoline. The equipment for separation of the heavy ends depends on the concentration of propane and/or butane in the cracker feedstock. For gas feed plants, the pyrolysis gasoline (pygas) yield is generally too low to justify the expense of a first-stage hydro-treater within the plant to make gasoline-pool product. Plants designed to crack ethane are therefore generally simpler in design than those designed to crack heavier feeds.

There may also be a need for feed gas preparation. For example, the Shell Sulfinol process is used to remove bulk H₂S and CO₂ from ethane feeds, although it produces a waste gas stream that requires disposal (e.g. to boilers). If required, trace levels of contaminants may be removed by adsorption using a regenerable or non-regenerable process. A non-regenerable process will require disposal of adsorbent at periodic intervals while a regenerable process may produce an intermittent waste gas stream for incineration or venting. The preparation of gas feedstock may occur at a remote plant. Further information on feed gas preparation may be found in the Refineries BREF.

7.2.3.2 Naphtha

'Naphtha' (also known as Light Distillate Fraction or crude gasoline) describes the C₆-C₁₀ hydrocarbons that boil in the gasoline boiling range of 50 - 200 °C. Naphtha cracking produces a broad range of co-products (from propylene to fuel oil) and typically 3.17 tonnes of naphtha are needed to produce one tonne of ethylene. 'Light virgin naphtha' (independent of crude source) gives a high yield of ethylene at high cracking severity. By contrast, 'full-range' and 'heavy' naphthas give higher yields of aromatics, iso-paraffins, and naphthenes, and lower yields of butadiene and ethylene.

A typical naphtha cracking process follows the same general processing sequence described for gas, but requires a higher steam/hydrocarbon weight ratio (about 0.5) to achieve the proper hydrocarbon partial pressure in the cracking furnace. Ratios in the range 0.25–0.60 may be used depending on the required cracking severity and the naphtha quality. At high severity, the cracking reaction uses a coil outlet temperature of 800 - 850 °C, whilst a low severity operation may be undertaken at 780 °C.

Since naphtha produces large quantities of pyrolysis gasoline and fuel oil, the cooling of the cracked gas requires an additional tower to remove the fuel oil constituents before the cracked gas enters the water quench tower. This allows gasoline to be separated from the condensed dilution steam and hence re-vaporisation of the dilution steam is practicable. When the additional tower (primary fractionator) is combined with the water quench tower this produces an overhead vapour stream containing most of the gasoline and lighter components, a heavy gasoline liquid stream, and a fuel oil bottoms stream.

Low pressure steam is generated in the quench oil system, which is used to cool the TLE effluent from about 400 - 450 °C to the tower bottoms temperature of 135 - 200 °C. The circulating water stream from the water quench tower can provide low level heat for feed preheating and tower re-boiling. The net fuel oil products are steam-stripped. The heavy gasoline is de-butanised and combined with the main gasoline stream from the de-butanised bottoms.

The fractionation sequence is the same as described for gas feeds. The principle co-product, propylene, has applications as a chemical grade product (approximately 95 % wt/wt purity) or polymer grade product (usually > 99 % wt/wt). Both products require the use of fractionation equipment, but in the case of polymer grade material further separation, in a C₃ splitter, is required.

In addition, the de-butaniser overhead product contains an appreciable quantity of butadiene (typically 40 - 45 %w/w) and is a good feed for an extraction unit. Several processing options are available to the producer, depending on specific circumstances. The raw C₄ stream can be selectively hydrogenated to butenes, fully hydrogenated to butanes (for recycle cracking or LPG sales) or sent to a butadiene extraction unit.

The quantity of cracked gasoline product (with 25 - 40 %w/w benzene and 10 - 15 %w/w toluene) usually justifies a hydrogenation unit to remove di-olefins as feedstock for aromatic extraction units. Alternatively, pygas may be fractionated to recover C₅ molecules for specialist applications, or heat soaked to produce a stable stream that can be blended into motor gasoline.

7.2.3.3 Gas Oil

Gas oils are classified as either 'atmospheric' or 'vacuum' according to their origin from an atmospheric crude tower or a crude bottoms vacuum column. Atmospheric gas-oil boils in the range 200 - 400 °C whilst vacuum gas oil (VGO) boils at 400 - 500 °C or higher. Some VGO (both treated and untreated) is commercially cracked, although the proportion is relatively small and there may be issues caused by high sulphur content (often above 1000 ppm).

The only significant variations from naphtha cracking occur in the furnace area and in the primary fractionator. As in naphtha cracking, the cracked gases are cooled by either indirect (transfer line exchangers) or direct (oil quench), or a combination of both. Since overall ethylene yields are considerably lower from gas oil (4.08 tonnes are needed for one tonne of ethylene) more feedstock is required. In combination with much higher dilution steam ratios, this imposes a significantly higher loading on the primary fractionator. Gas-oil primary fractionators are therefore larger, more complex, employ more heat recovery and produce more side-stream products.

A dilution steam/hydrocarbon weight ratio of 0.6 - 1.0 (depending on feed specific gravity) is required to achieve the proper hydrocarbon partial pressure at furnace-cracking conditions. Furnace design is extremely critical when a heavy feedstock such as gas oil is cracked since the maximum conversion of feed to olefin products is required while preventing excessive coking in the furnace tubes and fouling in the transfer line exchangers.

The average outlet temperature from the TLEs is higher than when cracking naphtha and the cracked effluent is more reactive, so a direct-contact oil quench may be used to cool the furnace effluent to the primary fractionator feed temperature (230 - 250 °C). As in naphtha cracking, the indirect quench operation produces steam at 120 barg. However, because of the large amount of heavy fuel resulting from gas-oil cracking, the primary fractionator bottoms can be run hotter and a portion of the steam from the circulating oil quench is recovered at around 15 barg, as well as at lower pressure.

The function of the primary fractionator is identical to that used in naphtha cracking, except that the fuel oil is produced in two streams; a side stream of light fuel oil and a bottom stream of heavy fuel oil. The cracked gas leaving the water quench tower contains all the gasoline and lighter components, except for a small amount of heavy gasoline that is stripped and combined with the main gasoline stream from the de-butaniser bottoms.

7.2.4 Other factors affecting yields

Several proprietary cracking technologies are available, mostly focused on the design of the cracking furnaces. Ethylene is usually the most valued product, but there will also be co-products (propylene, acetylene, a C₄ stream, aromatics in the form of pyrolysis gasoline) and by-products (methane-rich gas, hydrogen-rich gas, C₅ compounds, pyrolysis oil, C₃ compounds, light hydrocarbons). The downstream demand for other products will influence the design selection.

‘Severity’ is the most significant operating variable in adjusting the yields from hydrocarbon cracking and is a function of residence time, temperature, partial pressure and feedstock [Weissermel & Arpe, 1993 #59]. High severity (low residence time and high temperature) maximises the yield of primary olefins and reduces the secondary reactions that promote coking. The maximum attainable severity is restricted by the physical limitations of the furnace. Figure 7.7 illustrates how the key variables interact.

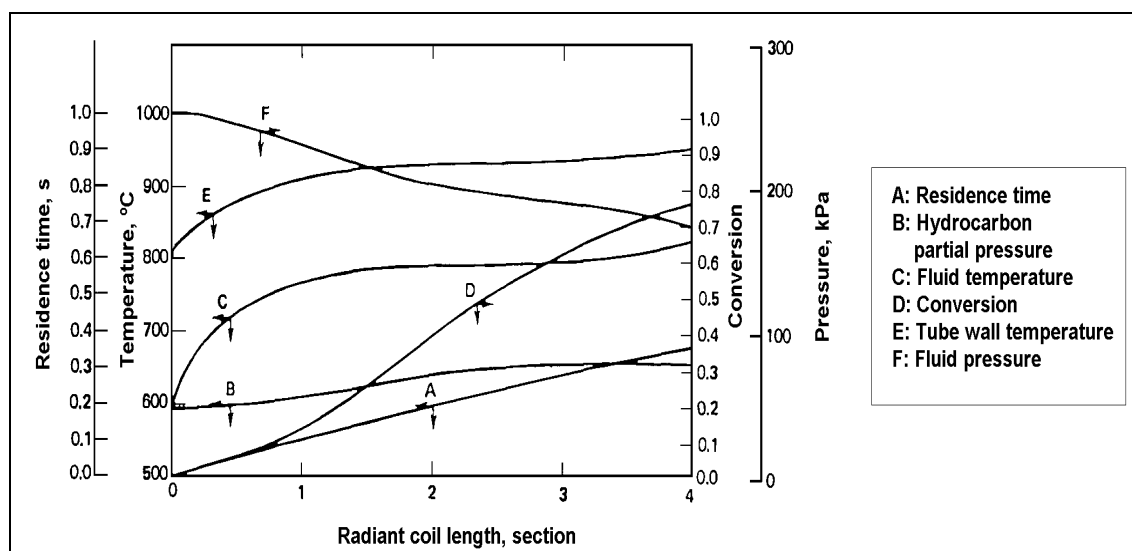

Figure 7.7: Major profiles for a typical naphtha pyrolysis coil [CEFIC, 1999 #54]

Cracking temperature. Temperatures of 400 °C cause the hydrocarbon chain to crack in the middle forming high molecular weight olefins, whereas higher temperatures cause chains to crack at the ends and form lower olefins. Higher temperatures also increase the cracking rate and this allows shorter residence times or lower partial pressures.

Residence time. Long residence times allow secondary reactions to form oligomers and coke, whilst short times (a few hundred milliseconds) increase the olefin share.

Partial pressure of hydrocarbons. The cracking reaction increases the number of moles and so lower partial pressures of hydrocarbons improves the olefin yield. Dilution gas is therefore introduced (usually as steam) to reduce the hydrocarbon partial pressure and encourages the cracking reaction to take place at lower temperatures. Increasing the steam to hydrocarbon ratio improves the yield of primary olefins and decreases the production of fuel gas. The optimum ratio is the point at which there is an economic balance between increased ethylene yield (selectivity), furnace throughput, and the higher operating / capital costs of steam generation.

7.2.5 Butadiene separation

Butadiene is predominantly isolated from C₄ hydrocarbon fractions that are produced during the steam cracking of ethane, LPG, naphtha, gas oil, and other higher boiling hydrocarbon fractions. Naphtha and gas oil are primarily used as raw materials in Western Europe, whilst in the USA ethane and propane make up more than 60 % of the starting materials. Butadiene cannot be separated from this C₄-hydrocarbon mixture by means of simple distillation, because 1,3-butadiene and butane form an azeotrope and there is need for liquid-liquid extraction or extractive distillation. All industrially used processes for butene separation are based on the higher chemical reactivity of isobutene. The principle is to prepare isobutene-derivatives that can be easily separated from the butene-mixture and that can be split back into isobutene thereafter.

In **Liquid-Liquid extraction** the selective solvent is a 20 % aqueous solution of Cuprous Ammonium Acetate (CAA) [Environment Agency (E&W), 1999 #7]. Mixed C₄ hydrocarbons are extracted counter-currently in a series of mixer-settlers. Distillation of the rich CAA solution at successively increasing temperature first liberates the lower-boiling hydrocarbons and, at 80 °C, butadiene, which is purified by re-distillation. The CAA solution is recycled to the extraction step after passage through carbon adsorbers (to remove polymers that might cause fouling). Pre-treatment of the C₄ feed is necessary to remove the acetylene that would otherwise combine with the copper to form explosive complexes. Releases to air of hydrocarbons and ammonia may occur from distillation and storage tank vents. Releases to water may occur from copper compounds, ammonia and hydrocarbons used in the process. Releases to land may involve copper-containing sludges, charcoal and polymerised hydrocarbons. This process is no longer used in Europe [CEFIC, 1999 #54].

The preferred method for the isolation of butadiene from C₄-fractions is **extractive distillation** using selective organic solvents. The affinity of hydrocarbons to polar solvents depends directly upon their degree of unsaturation. A highly unsaturated hydrocarbon is not only more soluble in a polar solvent, but the solvent is also more effective in decreasing the volatility of the hydrocarbon. The solvents used include acetone, furfural, acetonitrile (ACN), dimethylacetamide, dimethylformamide, and N-methyl pyrrolidone (NMP).

The **ACN process** comprises feed preparation, extraction, purification, and solvent purification and recovery [Environment Agency (E&W), 1999 #7]. Oxygen can initiate unwanted polymerisation and is removed from the feedstock by washing with sodium nitrite solution. Washed hydrocarbons are then distilled to remove C₃ hydrocarbons. The vapour-phase mixed hydrocarbons are contacted and absorbed in acetonitrile, while butanes and butene remain largely unabsorbed. ACN, rich in butadiene, is distilled and butadiene removed with some

butenes, acetylenes and 1,2-butadiene. Further distillation gives the purified product. Impurities gradually build up due to the degradation of the ACN solvent and are removed by taking a bleed from the circulating solvent and diluting it with water. Any polymers separate as oil in a coalescer. Acetamide and ammonia are removed in a solvent recovery column by distillation and recovered ACN is recycled. The ACN process may have releases to air of acetonitrile, hydrocarbons and ammonia (from reactor vents, solvent recovery column vents and during plant decommissioning for maintenance) and of acetamide (from solvent recovery column vents). Effluents can include ammonia and acetamide (from solvent recovery), acetonitrile (in process waste waters) and sodium nitrite / nitrate (in deoxygenation waste waters). Solid wastes include polymers from the distillation process.

In the **NMP process** (Figure 7.8), counter-current extraction of the feedstock produces a pure butenes stream and a pure butadiene stream [Environment Agency (E&W), 1999 #7]. The solvent is regenerated on a continuous basis in vacuum evaporation vessels to remove polymeric solids. Acetylenes and C₅ hydrocarbons are removed by distillation, with sodium nitrite added as a scavenger to inhibit polymer formation. Releases of hydrocarbons to air may arise from reactor and storage tank vents and during process plant decommissioning for maintenance. Potential effluents include n-methylpyrrolidone and sodium nitrite in process purges. Residue sludge is formed from the regeneration of spent n-methylpyrrolidone, which contains NMP, NMP polymers, sodium nitrate and butadiene.

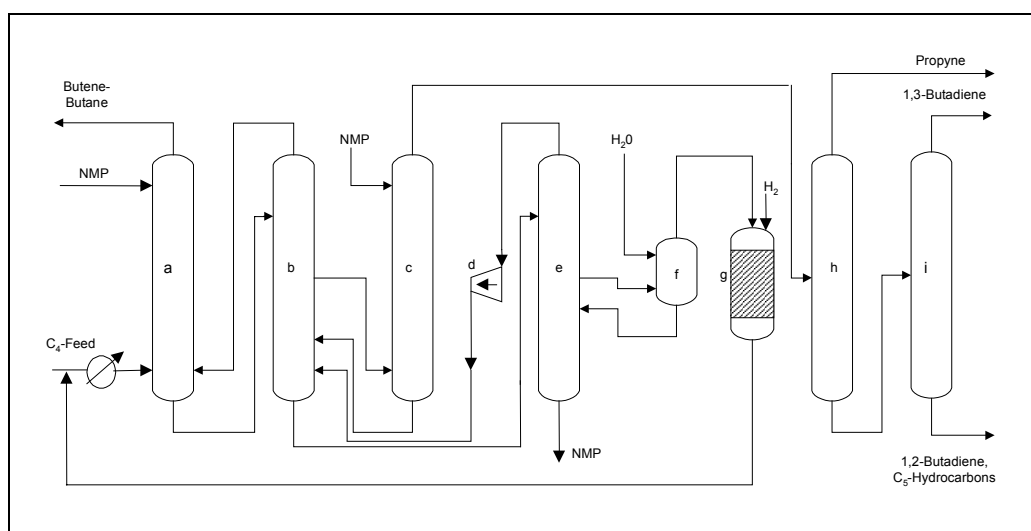

Figure 7.8: Extractive distillation of butadiene with NMP

Notation: a) Main washer; b) Rectifier; c) After washer; d) Centrifugal or screw compressor; e) Degassing tower; f) Water washer; g) Hydrogenation reactor (optional); h) First distillation; i) Second distillation [Environment Agency (E&W), 1999 #7]

7.2.6 Catalytic dehydrogenation of propane to propylene

Propylene can also be produced by the catalytic dehydrogenation of propane. Production of propylene by propane dehydrogenation is only of interest to producers where they wish to increase the production of propylene relative to ethylene, and who have ready access to LPG.

North Sea Petrochemicals in Antwerp uses the Lummus-Houdry process for the catalytic dehydrogenation of propane to propylene. The unit economics of this route are very dependent on the propylene/propane cost ratio and the process is fairly energy intensive. A leading technology was developed by UOP (called Oleflex). Thai Olefins already have a plant operating in Thailand and BASF-Sonatrach intend to build a unit in Tarragona, Spain. A further unit is under construction in Malaysia.

There are other technologies for increasing the production of propylene relative to ethylene (e.g. ABB-Lummus and IFP separately have processes for the metathesis of ethylene and butylene to make propylene, and can be used to optimise the output from the cracker where demand for propylene is high relative to ethylene. Propylene can also be produced by enhanced catalytic cracking (a refinery process in which ZSM-5 catalyst is used to increase the olefin yield), or by using Deep Catalytic Cracking (DCC) to the same end. None of the above technologies is expected to offer any significant environmental performance improvements against existing steam cracking technologies, and they are only relevant for specific location and commercial conditions.

7.2.7 Auxiliary chemicals and utilities

A number of auxiliary chemicals and utilities are used to support the steam cracking process and these may include:

- dilution steam is used to reduce the partial pressure of hydrocarbons in the cracking furnaces and to reduce coke formation. It may be generated by the vaporisation of primary fractionation spent water
- sodium hydroxide, sometimes in combination with amines, is used to remove the acidity from the compressed process gas
- methanol to dry the cold circuits before start-up, or to dissolve the solid hydrocarbon hydrates
- antifouling agents in the units for pyrolysis, compression, butadiene extraction, depropaniser and debutaniser
- antioxidants to stabilise the butadiene
- hydrogen to stabilise the crude gasoline, and hydrogenate the acetylenics in C₂, C₃, C₄ cuts
- hydrogenation catalysts (generally precious metal on inert support)
- gas drying agents (generally molecular sieves)
- a furnace for the regeneration of drying agents
- extraction agent for butadiene recovery
- flare systems provide safe relief in the event of plant upsets and start-up. Fuel gas is required for the flare pilot flames. Controls are needed to ensure smokeless operation
- nitrogen for permanent or intermittent (maintenance) inerting
- air and air plus steam for the decoking of the cracking furnaces
- plants typically have three large compressors (one each serving the charge gas, ethylene refrigeration and propylene refrigeration) and these frequently use steam driven turbines. Steam turbine drivers may also be used for boiler feed water pumps, circulating oil pumps (naphtha and gas oil feedstocks, only), circulating quench water pumps, and cooling water pumps
- pyrolysis flue gas analysers and other sampling systems (closed loop or to flare).

7.3 Consumption and emission levels

7.3.1 Factors influencing consumption and emissions

The generic factors that may affect consumption and emissions in LVOC processes were considered in Section 4.4. In addition, there are some specific factors that are relevant to understanding data from lower olefin processes [CEFIC, 2000 #110].

7.3.1.1 Plant boundary definition and the degree of integration

A number of operations are directly associated with olefins production, including feed pre-treatment, butadiene recovery or hydrogenation, gasoline heat soaking or hydro-treatment,

benzene concentration or extraction and tar (residue from heavy gas oil feeds) handling. Fully integrated olefins plants using naphtha or gas oil feedstock may include some or all of these associated processes within the cracker ISBL (inside battery limits), but these operations may be undertaken in separate facilities that also process streams from other plants.

Olefin plants require the principle utilities (steam, power and cooling water) as well as provision for waste water treatment. In addition they require the capability to flare waste gases during an upset condition and certain intermittent operations. In only a limited number of cases is the olefin plant a totally independent unit with dedicated services. More typically, the olefins plant is part of an integrated petrochemical and/or refining complex, where common utilities are provided by central facilities.

Olefin plants are frequently used to recover vent and purge streams from other units (e.g. polymer plants) which, on an integrated site, eliminates the requirement for disposal. Residues from the cracking of heavy feedstocks such as gas oil can also be recovered as fuel oil for subsequent steam and power generation.

Total Lower Olefin emissions will therefore depend on how the plant boundaries are defined, and what associated processes are within its battery limits. The following Lower Olefin plant boundaries are therefore assumed:

	Will normally include:	May include:
ISBL	<ul style="list-style-type: none"> • Cracking furnaces • Primary fractionation/water quench • Cracked gas compression /acid gas removal / drying • Cold fractionation • Refrigeration systems • Hot fractionation (only limited requirement for gas crackers) • Hydrogenation units as required • Intermediate storage 	<ul style="list-style-type: none"> • Feed pre-treatment (for contaminant removal) • Associated processes (e.g. propylene purification, butadiene extraction), gasoline heatsoaking, hydro-treatment, tar / residue handling) • Demin water and boiler feedwater treatment • Auxiliary boilers / power generation facilities • Cooling water systems • Effluent treatment systems (whole or partial) • Flare
OSBL	<ul style="list-style-type: none"> • Power generation and supply • Steam generation and supply • Ancillary services (e.g. air, nitrogen) • Effluent treatment (partial or whole) • Main storage 	<ul style="list-style-type: none"> • Auxiliary boilers • Cooling water supply / return • Flare

7.3.1.2 Feedstock issues

Emission levels are normally reported on a 'per tonne ethylene' basis. However, this can introduce problems when comparing plant performances since the actual emissions relate not only to ethylene production, but also to the production of other olefins, and to the feedstock selected.

On a per tonne ethylene basis, emissions will tend to be lower for those plants using gas feedstocks than those using naphtha and gas-oil. As a general rule, the percentage conversion of hydrocarbon to lower olefins reduces as the molecular weight of the feedstock increases. For illustration, approximately 80 % of ethane is converted to ethylene in the cracking process, whereas the ethylene yield from naphtha is typically 30 - 35 %. However, virtually no propylene (the next most important olefin) is produced from ethane cracking, whereas propylene production from naphtha can be as high as 70 % of ethylene.

Even when cracking identical feedstock, there is some flexibility to change the proportion of high value products by adjustment of cracking severity, according to the specific needs of the producer. Cracking severity and feedstock type can also affect operations such as furnace run

length (length of time between steam/air decokes) or acetylene converter run length (time between regenerations) which can have a secondary effect on specific emissions. Caution must be used when comparing emission levels on a 'per tonne of ethylene' basis. Industry performance benchmarking often considers other ratios such as: usage per tonne of ethylene product; usage per tonne olefins (ethylene plus propylene); and usage per tonne high value chemicals (ethylene, propylene, recovered hydrogen, butadiene and benzene).

Some olefin plant feedstocks give rise to particular emissions. Units cracking ethane, recovered directly from oil field sources, will generally have to remove and vent naturally occurring CO₂, before sending the feed to the cracking furnaces. Likewise, units processing gas recovered from integrated refinery complexes will normally require removal of sulphur compounds and other trace impurities before feeding to the furnaces or recovery section of the plant.

Units cracking gas oil or vacuum gas oil are more complex than ethane, LPG or naphtha fed units and are normally found on integrated refinery / petrochemical sites. Ethylene yield per tonne of feed is generally lower and additional investment and processing steps are required to handle the relatively higher volume of heavy fuel products formed in the cracking process. The sulphur in the liquid feed results in the production of more H₂S and acid gas components in the cracking process, which have to be removed before feeding to the recovery section of the unit. This is accomplished using standard refinery processing techniques such as caustic or amine scrubbing, with the acid gas components subsequently recovered as elemental sulphur or combusted to SO₂, depending on the site configuration. Such heavy feed plants produce a substantial quantity of steam cracked tar in which residual sulphur is concentrated. On an integrated site, this material is generally blended into the heavy fuel oil pool, or combusted to generate steam on ancillary boilers. Overall, the lower ethylene yield, the need to remove components arising from feed sulphur and the requirement to process steam cracker tar production, increases the specific emissions for an olefins unit fed with gas oil, relative to one fed with naphtha, LPG or ethane.

7.3.1.3 Scale of operation

Unit capacity (measured in tonnes of ethylene production) can have an impact on specific emissions, particularly to air. The technique used to estimate non-channelled (fugitive) emissions makes no allowance for throughput or the size of the source. Since most olefin units have a similar number of unit operations and point sources, plants with a low capacity and lower ethylene yielding feedstock will tend to show a disproportionately high specific emission to atmosphere. The scale of European ethylene plants has increased from an average initial installed capacity of 220 kt/yr in the 1960's, to 550 kt/yr for the period 1990 - 1995. Current 'world scale' is considered to be around 600 - 800 kt/yr [CEFIC, 1999 #43].

7.3.1.4 Plant age

Older plants will tend to suffer a technology disadvantage in that furnace conversion, selectivity, rotating equipment specification and overall energy efficiency are lower than in a modern plant. Older plants may have more direct emission routes for non-routine or emergency situations, e.g. atmospheric (as opposed to closed system) safety valve discharges. Older units may also have less well developed energy recovery systems, compression train efficiency, control systems and high-integrity equipment to avoid fugitive emissions. Older plants can therefore have higher specific emissions than modern units.

The current age profile of crackers in Europe is shown in Figure 7.9. Many operators have selectively replaced equipment and systems where it has been possible to demonstrate a financial benefit. As a result, nearly all plants have undergone some modification since their initial construction; often involving improvements that directly or indirectly impact on

emissions (e.g. the replacement of single-seal pumps with tandem or double-sealed units, and the installation of DCS – distributed control systems). However, in practice the major refurbishment of older plants is often restricted by plant congestion and the close proximity to other plants on established complexes.

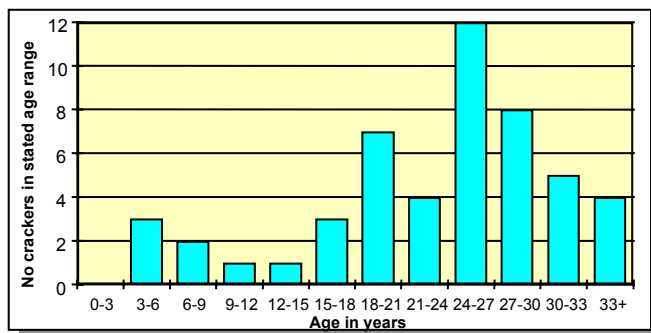

Figure 7.9: Age distribution of European crackers
[CEFIC, 1999 #43]

7.3.2 Air emissions

Table 7.5 summarises the principle pollutants and their sources, together with the range of emission levels met in most European crackers. Further detail on the main unit operations is provided in the following sections.

Source	Pollutant				
	NO _x	SO ₂	CO	VOC	Particulates
Gas-fired furnaces/heaters	X	X	X	X	
Gas-fired turbines	X	X	X	X	
Liquid fuel boiler	X	X	X	X	X
Point sources ⁽³⁾	X	X	X	X	X
Maintenance activities				X	
Non-channelled emissions				X	
Decoking operations	X		X	X	X
Sour gas disposal		X			
Regeneration furnaces	X	X	X	X	
Emission factor (kg/t ethylene)	1.0 - 2.8	0.01- 3.3 ⁽¹⁾	0.2 - 1.0	0.03 - 6.0	0.05 - 1.5 ⁽²⁾

1. Includes gas oil and vacuum gas oil units containing up to 1 % feed sulphur.
2. Includes units combusting steam cracker tar on ancillary boilers.
3. Atmospheric vents, sample points, flares, intermediate storage [Federchimica, 2000 #123]

Table 7.5: Principle emissions from Lower Olefin processes
[CEFIC, 2000 #110]

VOC emissions from point sources are not significant from a well-run plant in normal operation. Fugitive VOC emissions may occur due to leakage and can cause odours.

7.3.2.1 Furnace area (steady state operation)

The furnace area is defined as that part of the process comprising the pyrolysis heaters, complete with heat exchange equipment for generating high pressure steam, and any separately fired steam superheaters. It excludes auxiliary boilers and regeneration furnaces.

In volume and pollutant terms, the most significant emissions to air result from the combustion of fuels in the pyrolysis cracking furnaces. The operating conditions of the cracking furnaces

are frequently changed in order to provide the desired product distribution and this may affect optimal control of the combustion process [Federchimica, 2000 #123].

A CEFIC survey has elicited responses from 39 Lower Olefin producers, covering 42 crackers (more than 80 % of steam cracker population) and 441 furnaces. Data on emissions of carbon monoxide and nitrogen oxides are given in Table 7.6.

	CO (mg/Nm ³)		NOx (mg/Nm ³)	
	Number	Range	Number	Range
Full range	35	0.2 - 620	39	61 - 250
1st tier	12	0.2 - 12	13	61 - 110
2nd tier	12	12 - 30	13	110 - 143
3rd tier	11	30 - 620*	13	145 - 250
* Includes 2 figures, reported as > 250 mg/Nm ³ , which are believed to have been incorrectly reported. Reference conditions were not collected in the CEFIC survey but the concentration data can be interpreted as 30 - 60 minute averages at normal temperature and pressure, 3 % oxygen, dry gas.				

Table 7.6: CEFIC survey response on CO and NOx emissions
[CEFIC, 2000 #110]

Sulphur dioxide emissions. 22 respondents to the CEFIC survey reported levels of SO₂ emissions in the range 0.1 - 100 mg/Nm³ (as 30 - 60 minute averages at normal temperature and pressure, 3 % oxygen, dry gas). All but 3 are less than 20 mg/Nm³, which corresponds to the expected figure with normal sweet residue gas (methane/hydrogen). For this reason SO₂ emissions are not normally considered to be significant for steam crackers.

Particulate emissions. 15 respondents to the CEFIC survey reported particulate emissions in the range 0.2 - 25 mg/Nm³. This is consistent with information from [InfoMil, 2000 #83].

7.3.2.2 Furnace area (decoke operations)

All cracking furnaces require periodic de-coking to remove carbon build-up on the radiant coils. The carbon layer acts as an insulator, and requires the use of higher tube metal temperatures to maintain the desired feedstock conversion. At a pre-determined level, dictated by the coil metallurgy, the furnace must be de-coked to restore its performance and the carbon is burned to carbon dioxide. Cycle times vary significantly for different feedstocks, coil configurations and the operating severity, but are typically in the range 14 - 100 days. It should be noted, however, that the extent of coke build-up is time dependent, so those furnaces requiring frequent de-cokes will generally have a much lower coke build-up than those with extended cycles.

On the basis of 14 CEFIC survey responses, particulate emissions were reported in the range 8 - 600 mg/Nm³, although the highest figures relate to peak values observed during dry de-dusting. De-coking emissions are not monitored by dedicated equipment (e.g. on-line analysers) since furnace de-coking is an infrequent operational mode (typically only 3 % of the time). During the de-coking phase, process control is important to minimise particulate emissions and there is typically visual inspection of the emission point and close supervision of the process parameters (e.g. temperatures).

CO emissions are reported in the range 1 - 2700 mg/Nm³ (as 30 - 60 minute averages at normal temperature and pressure, 3 % oxygen, dry gas). The highest figures were again encountered at the start of the operation.

7.3.2.3 Flaring

All crackers are provided with flare gas systems to allow safe disposal of any hydrocarbons or hydrogen that cannot be recovered in the process. This is particularly the case during unplanned shutdowns, and during start-ups, when the intermediate streams have not reached the compositions required to enable the production of full-specification products.

A particular need for flaring may arise during cracker start-up. The duration of the start up period is dependent on such factors as the length / nature of the preceeding shutdown, what (if any) equipment has been opened for maintenance and the degree of plant integration. The start-up period may vary between 15 hours and a few days, and may produce up to 60 tonnes/hour of cracking furnace gases that require flaring [Austria UBA, 2000 #133].

It is reported that some steam crackers can achieve flareless start-up by initially running the fractionation stage on pure ethylene and then gradually introducing furnace off-gases [Bairlein, 1997 #135]. Flareless start-up has the advantages of much reduced exhaust gas volumes and lower noise pollution. Care is needed to ensure that the extended start-up period does not increase overall emissions and does not compromise smooth operation or high integrity tripping systems. At new plants the additional investment costs of flareless start-up are very low and existing plants can be retrofitted with acceptable costs [Austria UBA, 2000 #133].

However, flareless start-up is not a standalone piece of technology that can be purchased and applied to all plants. The possibility of implementing flareless start-up is dependent on the availability of large storage facilities (for ethylene, propylene, raw C4 and off-specification product) and the integration of the plant in a large refinery or petrochemical site with a fuel-gas network. In addition, the flexibility to operate fractionation equipment on recycle depends greatly on the existing plant design. Flareless start-up therefore represents a concept rather than a specific technology or methodology for operation. The extent to which it can be applied to new or existing facilities, and its impact on overall emissions, is site dependent and may vary greatly. The technical feasibility of implementation therefore requires case-by-case consideration.

Of the 38 respondents to the CEFIC survey [CEFIC, 2000 #110], all have at least one elevated flare. Eleven crackers have a single elevated flare, 16 have two flares (elevated/elevated or elevated/ground) with the remainder having more than two flare disposal routes. The ranges of hydrocarbon quantities sent to flare are:

	kg hydrocarbon feed /t ethylene of product
1 st tier	0.003 – 2.2
2 nd tier	2.4 – 18
3 rd tier	21 – 50

The normally accepted material loss for an upper quartile operating performance is around 0.3 - 0.5 % of hydrocarbon feed to the plant. This translates to 5 to 15 kg hydrocarbons/tonne ethylene, depending on feedstock, the majority of which would be routed to the flare system [CEFIC, 2000 #110].

7.3.2.4 VOCs from point sources

During normal operation there are very few VOC emissions from the cracking process because they are recycled into the process, used as a fuel or routed to associated processes on an integrated site. Elevated VOC emissions from ethylene plants are intermittent, but occur during plant start-up and shutdown, process upsets and emergencies. VOCs may be emitted from pressure relief devices, intentional venting of off-specification materials or depressurising and purging of equipment for maintenance. Crack gas compressor and refrigeration compressor

outages are potential sources of short-term, high rate VOC emissions. The chief source of benzene emissions during normal operation is the crack gas compressor lubricating oil vent. In general, intermittent emissions, all pressure relief devices, and emergency vents are routed to flare through the main process vent, which is usually controlled. The relief valve from the demethaniser usually vents to atmosphere, but the valve is operated very infrequently and emits mainly hydrogen and methane. VOCs from such sources as cracking furnace flue gas, pyrolysis furnace decoking, acid gas removal and hydrogenation catalyst regeneration are not generally significant [Rentz, 1999 #114].

Hydrocarbons are mostly emitted due to leakage and flaring of the residual gases. In the Netherlands, VOC emissions were attributed to 72 % from leakage losses from appendages, pumps, etc., 18 % from flaring and disruption, 1 % from losses due to storage and handling, 5 % from combustion and 4 % from other process emissions. About 73 % of the VOC emissions can be considered as production independent (leakage plus losses due to storage, etc.), but process operation time dependent (i.e. production capacity dependent). The remaining 27 % is production dependent. Thus, some 80 % of the total emissions (excluding combustion and storage) is attributable to fugitive emissions and 20 % to flaring [Rentz, 1999 #114].

Somewhat dated information [EC VOC Task Force, 1990 #116] reported that VOC emissions from steam cracking were composed of 50 % paraffins, 30 % ethylene, 10 % olefins (including propylene) and 10 % others. The total VOC emission of 0.5 - 4.9 kg / t ethylene was attributed to:

saturates ($C \geq 2$)	0.3 - 2.5 kg / t ethylene
ethylene	0.1 - 1.0 kg / t ethylene
other unsaturates (C_2-C_5)	0.1 - 0.5 kg / t ethylene

The different countries reporting to the CORINAIR 90 emission inventory indicated a wide range of VOC emission factors from 0.841 to 5 kg/t ethylene product [Rentz, 1999 #114]. However, a lower VOC emission factor (0.6 kg/t ethylene product) has been calculated for the Netherlands [EEA, 1999 #118].

Specific emissions are 147 g/t product for benzene emissions from storage and 22.1 g/t product for overall VOC emissions from floating roof tanks [Rentz, 1999 #114].

CEFIC reports that the vent emissions from individual European plants are all below 60 tonnes/year. Assuming an average 400 kt/year cracker, this equates to <0.15 kg VOC / tonne ethylene. This figure is much lower than those cited by other sources (0.5 to 5 kg VOC / tonne ethylene) because the CEFIC definition of point sources disregards fugitive emissions, the emissions from flaring and from the furnaces. The overall figures given by CEFIC in Table 7.5 are more comparable.

The EC has estimated [EC DGXI, 1992 #23] that European ethylene production results in a total VOC emission to atmosphere of 14 kt/yr (based on production capacity of 13.8 million tonnes per annum).

(Note: Part of the apparent variation between VOC loss data (above) may well be attributable to the use of different measurement techniques on different sites.)

7.3.2.5 Fugitive emissions

Steam crackers are large complex units that have a high number of components with potential to give rise to fugitive emissions. Fugitive emissions may arise from valve glands, pipeline flanges, open-ended (non-blanked) lines, pressure relief valves and other piping components, in addition to the pump/compressor seals and sample points discussed above. Many of the process

streams are light (containing at least 20 % of substances with vapour pressure greater than 300 °Pa at 20 °C) and at high pressure (1500 - 3000 kPa). Fugitive losses can therefore constitute a significant proportion of overall steam cracking process emissions and there are examples of fugitive emissions accounting for two-thirds of total VOC emissions [InfoMil, 2000 #83]. Experience from one olefins complex has shown that leaking valves contribute 60 - 70 % of total fugitive emissions (including rotating equipment and relief devices) while the proportion from flanges is relatively small (<10 %).

7.3.3 Water emissions

There are three effluent streams that are specific to the steam cracking process, namely: process water, spent caustic and decoke drum spray water (where installed). In addition, cooling or boiler water blowdown, surface or maintenance water may also be generated. The main potential pollutants include: hydrocarbons; dissolved inorganic solids and particulates; materials that may exert a chemical or biological demand for oxygen; and trace quantities of metal cations (see Table 7.7).

Pollutant	Source
Monocyclic aromatic compounds (naphthalene and phenol) and other hydrocarbons. Sulphates.	Condensate purge on dilution steam, quench water, wash-water, de-coking
Spent caustic, sodium sulphate and sodium thiosulphate.	Acid gas removal unit
Coke, tar and oil	Spillage and sampling
Polymer	Sludge dewatering
Green oil (C ₂ polymerisation product)	Acetylene hydrogenation
Zn/Cr and Zn/P formulations, hypochlorite, sulphuric acid, sulphates	Cooling water blowdown
Coke in water	Wet de-coking systems
Phosphates, amines	Steam boilers bleed

Table 7.7: Effluent pollutants and their sources

Based on [CEFIC, 1999 #54] [EC DGXI, 1993 #8] and [InfoMil, 2000 #83]

7.3.3.1 Process Water

In the steam cracking process, the hydrocarbons are cracked in the presence of dilution steam to improve the reaction selectivity to the desired olefin products. This steam is then condensed, and has to be removed from the furnace products before they can be further processed and separated. Process water refers to the bleed of condensed dilution steam. The process water may contain phenol and other dissolved or suspended hydrocarbons. Process water is always subject to further treatment [CEFIC, 2000 #110].

A CEFIC survey elicited responses from more than 80 % of the European ethylene production capacity (the 38 pertinent answers represent 42 crackers in 34 locations). 32 of the crackers surveyed utilise some form of Dilution Steam Generation (DSG) to enable up to 90 % of the process water flow to be recovered and recycled to the furnaces. Of the 6 remaining crackers some are gas-oil crackers (for which the DSG system is not practicable) and these direct the process water to a treatment technique.

The emission factor of crackers including a DSG is within 0.03 to 2 m³/t ethylene, while the range is 0.03 to 7 m³/t ethylene for the whole population of crackers.

7.3.3.2 Spent caustic

Acid gases (carbon dioxide, mercaptans, hydrogen sulphide) are scrubbed from the process stream (cracked gas compression system) using sodium hydroxide (caustic). Spent caustic is purged from the base of the caustic wash tower. The exact volume and composition of spent caustic are directly linked to the sulphur content in the feedstock but also depend on the cracking severity and the operation of the caustic tower. The COD before treatment is typically in the range 20 – 50 g/l and other components are:

- sodium hydroxide (0.5 - 5.0 % wt)
- sodium sulphide (0.5 - 5.0 % wt)
- sodium carbonate (0.5 - 10.0 % wt)
- dissolved hydrocarbons (0.1 - 0.3 % wt) including up to few hundred ppm of benzene
- liquid phase hydrocarbons may be present (including phenols and cresols if naphtha or heavy feedstocks have been cracked)
- carbonyls, mercaptans, cyanides and dienes in smaller quantities.

The sulphide content of this aqueous stream is typically 10 g sulphide/te ethylene. The total salt content is reported as 0.12 to 1.10 kg/te ethylene where air oxidation is used (5 cases) and 1.3 to 6.0 kg/te ethylene where acidification is used (10 cases). Plants using air oxidation for treatment of the spent caustic stream will tend to have a higher total salt loading than those employing acid neutralisation [CEFIC, 2000 #110].

7.3.3.3 Total aqueous effluent stream

This effluent includes all aqueous streams leaving the core unit, including the blowdown from the cooling water circuit, the bleed from the steam generators and the process water and spent caustic streams. In the CEFIC survey respondents were asked to ignore rainwater, as well as the cleaning/rinsing water associated with maintenance activities. However, in many cases, all aqueous streams, from whatever source, pass through some or all of the treatment facilities, and the contribution of each cannot be easily isolated for reporting purposes. Accordingly, the total aqueous effluent flow rate (per tonne of ethylene) can vary greatly, depending on the individual water management requirements at the location. Factors which influence the quantity of effluent include [CEFIC, 2000 #110]:

- whether a dilution steam generation system is provided
- whether the cooling water circuit is ‘once-through’ or ‘closed loop’
- whether the spent caustic stream is incinerated or processed through an air oxidation unit
- whether surface water and water used in maintenance activities is directed via the effluent treatment unit.

Typical dilution steam/hydrocarbon feed ratios are 0.5/0.6 to 1 in the furnace feed for liquids, 0.7/0.8 for gas-oil and 0.3/0.5 for gas crackers. On a per tonne of ethylene basis, the range is therefore between 1 t/t and 4 t/t. With no dilution steam generation, the contribution of the process water stream to the total waste water flow from the plant is therefore also between 1 and 4 m³/t ethylene. Dilution steam generation systems are typically designed to recycle around 90 % of the process water (i.e. a 10 % purge rate), which would therefore reduce the contribution to aqueous effluent from this source to 0.1 to 0.4 m³/t ethylene.

The aqueous effluent stream leaving the core unit is always subjected to further treatment and this may include [CEFIC, 2000 #110]:

- a steam stripping system in 30 cases (8 without)
- a decantation step to remove free oil and suspending solids (API or CPI separator system) in all reported cases (37 answers)
- a final bio-treatment (24 positive answers).

Table 7.8 shows the effluent quantity and quality both before treatment (the stream leaving the core unit, upstream of final treatment) and after treatment. The data are based on 39 survey responses representing 42 crackers on 34 sites. Final treatment is reported to reduce TOC load by 68 to 96 % (based on 19 reports). Waste water after treatment also has a Total Suspended Solids of <50 mg/l (typical value exiting a standard API separator) and a pH 6 to 9 [CEFIC, 2000 #110].

Range	Volume (m ³ /t ethylene)			TOC (g /t ethylene) ⁽⁵⁾			TOC (mg/l) ⁽⁵⁾		
	Pre-treatment (1)	Post-treatment (1)	N ^o off	Pre-treatment (2)	Post-treatment (6)	N ^o off	Pre-treatment (3)	Post-treatment (4, 6, 7)	N ^o off
Full	0.02 - 8.5	0.02 - 8.5	36	13 - 2700	2 - 800	26	30 - 1650	1.8 - 330	26
1 st tier	0.02 - 1.5	0.02 - 1.5	12	13 - 210	2 - 23	9	3 - 100	1.8 - 13	9
2 nd tier	1.5 - 2.5	1.5 - 2.5	12	220 - 400	30 - 60	9	120 - 200	15 - 33	9
3 rd tier	2.5 - 8.5	2.5 - 8.5	12	430 - 2700	65 - 800	8	200 - 1650	46 - 330	8

1. The lowest figure (0.02) is probably an outlier and the next lowest is 0.3. The range excludes data from plants using a once through cooling water system, but it includes data from plants that do not have facilities for dilution steam recovery from primary fractionator / quench column spent water.
2. The highest value (2700) is maybe an outlier and the next highest figure is 1400.
3. Only 2 figures exceeded 400.
4. When expressed as COD, the full range is 5 - 800 ppm.
5. Responses made in units of COD have been converted to TOC using a factor of 2.5 (COD/TOC = 2.5). Some organic load is made up of oxygen-containing hydrocarbons including methanol (about 10 ppm), acetaldehyde (about 15 ppm) and traces of acetone and acetic acid [Austria UBA, 2000 #133].
6. The range includes data from plants without biological oxidation systems.
7. There is evidence to suggest that lower figures may be due to differences in analytical technique and / or assumptions in determining the contribution of lower olefin effluent to a central waste water treatment facility.

Table 7.8: CEFIC survey results for total aqueous effluent before and after treatment [CEFIC, 2000 #110]

7.3.4 Solid wastes

Relatively little solid waste is generated in the steam cracking process when running on gas or naphtha, although there is more significant production on a gas-oil feedstock. The bulk of steam cracker solid waste is organic sludges and coke, but there are also specific arisings of spent catalyst, spent adsorbents and solvent purges. In addition, there are generic wastes, such as spent oil, oil filters/cartridges and air-drying adsorbents (see Section 4.3).

- **Organic sludges.** Organic sludges are liquid, pasty or solid materials collected during normal operation, start-up, shutdown, drainage and cleaning of the unit. They typically arise from API separators, the quench oil system, spent methanol, spent lubricating oil, bottoms drains of vessels and settlers, and polymeric material removed from pump strainers and filters.
- **Coke.** Coke fines are recovered from gas dedusting during decoking.
- **Spent catalysts.** Catalysts (from acetylene, butadiene, steam cracked naphtha hydrogenation and DeNO_x units) have an economic lifetime of roughly 5 years. Once efficiency declines to an unacceptable level spent catalysts are generally (in 23 of 26 cases) returned to the catalyst supplier for recovery of the noble metal.
- **Spent adsorbents.** Drying adsorbents (alumina, molecular sieves) have a typical economic lifetime of 3 - 4 years. They are generally landfilled after regeneration/deactivation.
- **Solvent purge.** Where the feed or cracked gas contains substantial quantities of acid gas (particularly carbon dioxide) this is typically removed using an amine or chemical absorption/stripping system. The selected solvent is often downgraded by the process materials and requires regeneration to restore performance. However, to maintain solvent quality and prevent the build-up of undesirable by-products, the solvent is occasionally purged, resulting in a heavy liquid or semi-solid waste. This is generally incinerated.

After excluding those coke emissions from tar tank cleaning (restricted to heavy feed cracking) the reported amount of solid waste of a cracker represents 0.05 to 6.0 kg/t ethylene [CEFIC, 2000 #110]. The rates of arising of specific wastes are given in Table 7.9.

	Catalyst/Desiccants ⁽²⁾		Organic sludges ⁽³⁾		Coke	
	Number of plants	kg/t ethylene	Number of plants	kg/t ethylene	Number of plants	kg/t ethylene
1 st tier	11	0.009 - 0.005	11	0.02 - 0.12	12	0.011 - 0.07
2 nd tier	11	0.06 - 0.084	11	0.13 - 0.64	12	0.085 - 0.154
3 rd tier	12	0.09 - 0.965	11	0.7 - 4.48	13	0.159 - 7.1 ⁽¹⁾
(1) 35 results were <0.58 kg/tonne						
(2) Figures are influenced by the accounting method and whether wastes from turnaround shutdowns are included (when reactors and dryers are more likely to be recharged)						
(3) The wide range is due to how the waste quantities are assessed						

Table 7.9: Survey response on arisings of catalyst / desiccants, organic sludges and coke [CEFIC, 2000 #110]

7.3.5 Energy consumption

The steam cracking olefins process is highly endothermic, and requires large quantities of energy at high temperature (>800 °C) to achieve feedstock dissociation, whilst at the same time requiring the application of cryogenic separation processes (involving deep refrigeration to temperatures as low as -150 °C) to separate and purify the products. Steam crackers are therefore designed to be highly energy-integrated units, recovering as much as possible of the energy required to be input at the front-end of the process to convert to the work required for the separation processes. This is usually accomplished by raising high-pressure steam in the furnace area, which is then used to drive turbines for cracked gas compression and refrigeration systems.

Overall energy utilisation of crackers is the most significant factor influencing the cost of conversion of the selected feedstock to the desired olefins products. This information is therefore commercially sensitive since it provides a key indicator to the performance of a given plant. CEFIC has collected energy information from its members under a strict confidentiality agreement that allows anonymous analysis of the industry as a whole. Plant by plant comparison is extremely difficult, particularly for energy consumption, where feedstock effects, site energy integration, size and age of the unit are just some of the factors that influence performance. In addition, all forms of energy (fuel burned directly or indirectly, steam imports/exports and electricity consumption/generation) must be taken into account to make meaningful comparisons.

Although CEFIC were unable to fully verify the energy consumption and CO₂ release figures obtained by their survey, they have applied simple consistency checks to identify obvious data outliers, namely [CEFIC, 2000 #140]:

- The ratio {GJ per tonne ethylene / GJ per tonne olefins} gives a simple severity index of the cracker. All 42 figures are within 1.0 to 1.84, with 3 figures below 1.4 and 4 figures above 1.7.
- The ratios {GJ per tonne ethylene / tonnes CO₂ per tonne ethylene} reflects an emission factor of the energy usage. All 42 figures are within 13.6 to 19.9, with 3 figures below 16.5 and 4 figures above 19.0.
- For each response, the ratios {GJ per tonne 'X' / tonne CO₂ per tonne 'X'} have been checked to ensure consistency.

A standardised approach has therefore been taken, using appropriate energy conversion factors. The analysis has been undertaken against two parameters: per tonne of ethylene production, and

per tonne of high value (HV) chemical production (ethylene, propylene, butadiene, benzene and high purity hydrogen production). This approach is commonly used in other industry benchmarking comparisons to recognise the large variation resulting from the selected feedstock. Table 7.10 shows that ethane is the most energy efficient feedstock for ethylene production.

Feedstock	GJ/tonne ethylene	GJ/tonne HVCs
Ethane	15 - 25	12.5 - 21
Naphtha	25 - 40	14 - 22
Gas Oil	40 - 50	18 - 23

1 GJ (Giga Joule) = 10^9 Joules

Table 7.10: Energy consumption with different feedstocks
[CEFIC, 2000 #110]

Energy consumption of butadiene plants is determined by the difficulty of the separation task (i.e. the high levels of reflux), and the choice of coolant (pressurised or liquid gas). Energy consumption also depends on the local situations such as the cost of electricity / steam and the ambient environmental conditions. The energy consumption may therefore range from 5.8 to 9.5 GJ per tonne of butadiene [CEFIC, 1999 #54].

7.3.5.1 Overall energy consumption

The overall energy consumption of crackers is shown in Figure 7.10 but since this takes no account of scale, age, location or feedstock, the absence of any clear correlation is understandable. However, the analysis shows how the energy consumption range reduces from <25 - >40 GJ/t, when expressed as 'per tonne of ethylene', to <15 - >20 GJ/t, when expressed as 'per tonne of total high value chemicals'. It is therefore important to recognise the multi-feed / multi-product nature of olefin plants and the potential for misleading comparisons against a single reference (e.g. ethylene production).

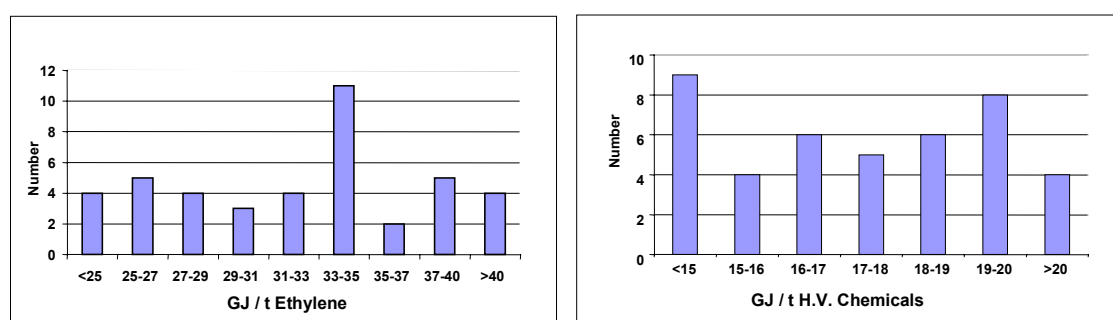

Figure 7.10: Cracker energy consumption (per tonne of ethylene and high value (HV) products)
[CEFIC, 2000 #140]

7.3.5.2 Carbon dioxide emissions

CO₂ emissions are shown in Figure 7.11 taking into account the CO₂ emissions from the generation of power and steam imported to the plant. The majority of plants operate below 2.1 tonnes CO₂ per tonne ethylene and a considerable number of plants operate below 1.5 tonnes CO₂ per tonne ethylene. As in the overall analysis, the range narrows considerably when compared against HVCs with a median around 0.9 to CO₂/t HVC, and a spread of <0.7 to CO₂/t to >1.3 to CO₂/t.

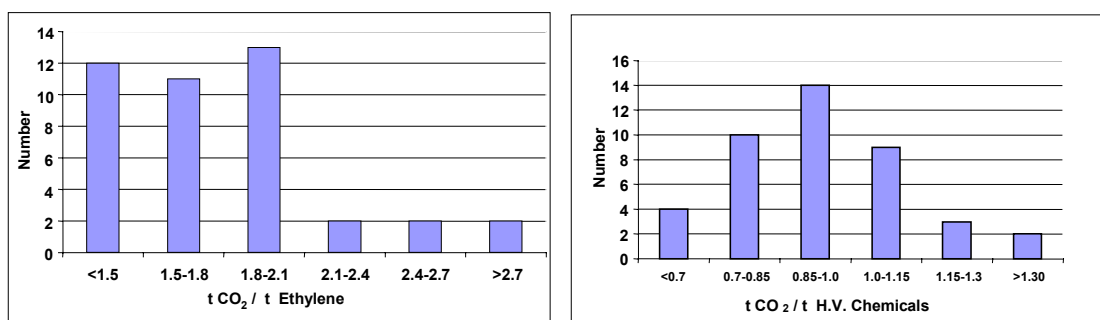

Figure 7.11: Carbon dioxide emissions (per tonne of ethylene and high value (HV) products) [CEFIC, 2000 #140]

7.3.5.3 Plant age

As an insight into the influence of plant age, Figure 7.12 compares the energy utilisation of crackers constructed prior to and since 1975. There is no clear correlation that older plants are necessarily less efficient than newer units, but this is more likely to be the consequence of ongoing re-investment in these units, principally to maintain a reasonably competitive position relative to 'best-in-class'. Energy utilisation is the most significant factor in influencing conversion cost and so many producers have replaced furnaces, modified compressor sets, etc since the units were originally installed. Whilst most of these changes have been instigated by the need to increase capacity, they have also improved overall energy efficiency.

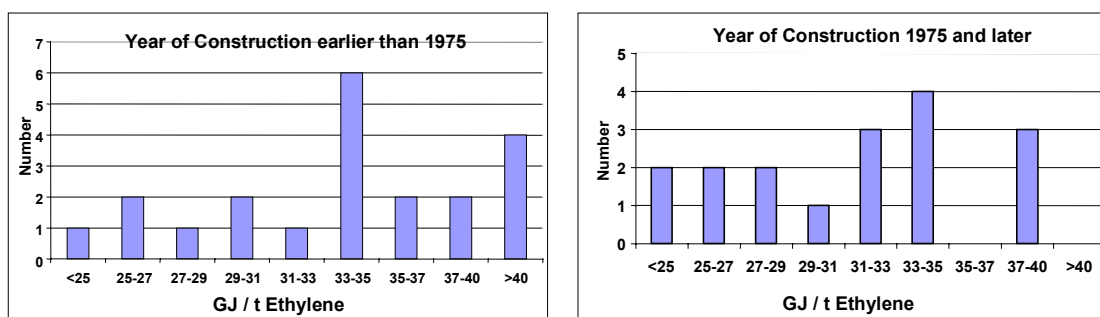

Figure 7.12: Energy consumption and plant age [CEFIC, 2000 #140]

7.3.5.4 Plant size

Figure 7.13 considers the possible impact of plant size by comparing the energy consumption of plants with less than and greater than 450 kt capacity (the median plant scale in Europe). Again, no clear correlation is possible, particularly for the larger units.

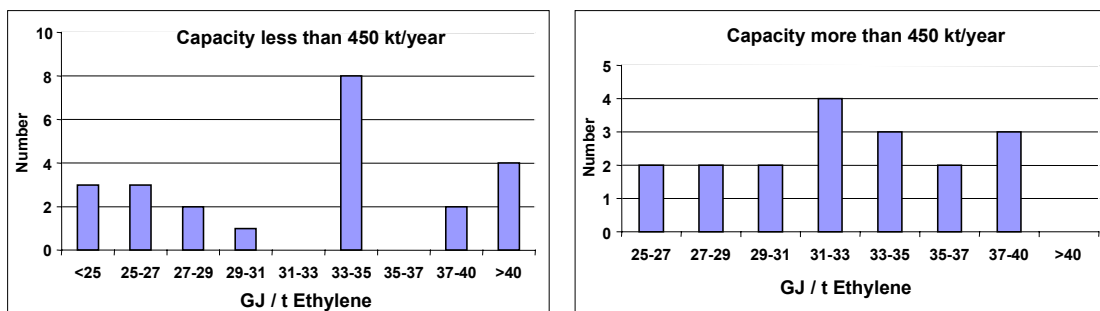

Figure 7.13: Energy consumption and plant size [CEFIC, 2000 #140]

Many factors influence the energy utilisation of olefin plants. Over the years, considerable improvements have been made in the energy efficiency of furnaces, rotating machinery and the separation processes, and there is evidence to suggest that the industry, as a whole, has responded to these developments by incorporating them in retrofits and major expansions. Indeed, very few plants are currently operating with the same capacity and equipment with which they originally commissioned. This process of continuous development has tended to maintain energy performance at a consistent level when considered on a per tonne HVC basis. The significant influence of energy utilisation in the cost of conversion also serves to provide the incentive for continuing this process.

7.3.6 Example plants

A number of Member States have submitted data on the environmental performance of their own lower olefin plants and this is summarised below together with World Bank data. The collection of this information has not been co-ordinated according to any pan-European protocol although there may have been protocols at Member State level. The data are presented in a variety of formats and should be seen as real-life examples of plant performance. Accurate interpretation of the data may require further information from the originating Member State.

7.3.6.1 The Netherlands

Source	Type	Pollutant	Emission factor (kg/tonne of product)		
			Producer A	Producer B	Producer C
Furnaces	Combustion	NOx	0.3	1.05	0.27
		CO	0.008	3.4	0.62
		Particulates	unknown	0.4	unknown
Crackers and connected units	Point sources	VOC	0.007	0.001	0.040
		Benzene	-	-	-
	Fugitive	VOC	0.17	0.40	0.035
		Benzene	0.0003	-	0.0044

Table 7.11: Air emissions from three Dutch steam crackers in 1998
[InfoMil, 2000 #83]

Source	Destination	Pollutant	Emission factor (kg/tonne of product)		
			Producer A	Producer B	Producer C
Alkaline oxidation	Public sewer (A)	Sulphate/Thiosulphate		0.87	0.0002
	WWTP (B)	MAH	0.04	0.076	
	WWTP (C)	PAH (naphthalene)	< 0.001	0.0004	n.a.
				< 0.001	negligible

Table 7.12: Waste water emissions from three Dutch steam crackers in 1998
[InfoMil, 2000 #83]

Pollutant	Producer B		Producer C	
	Effluent concentration	Reduction efficiency (%)	Effluent concentration	Reduction efficiency (%)
MAC	0.2 µg/l	>99	Not known.	>99
PAC	1.6 µg/l	85	Not known	>99

Table 7.13: Efficiency of central WWTP treating effluent from two Dutch crackers
[InfoMil, 2000 #83]

7.3.6.2 Germany

A German steam cracker with an ethylene capacity of 438 kt/yr is reported [UBA (Germany), 2000 #91] to have measured emissions (as half hour averages) of carbon monoxide (50 mg/m³), total carbon (10 mg/m³) and dust (2 mg/m³). Continuous measurement of sulphur dioxide gave 4.5 mg/m³ and nitrogen dioxide 120 mg/m³. Emission and consumption data for two other German plants is given in Table 7.14.

Medium	Emission / consumption data	
	Plant 4 (Internal No. B1) ⁽¹⁾	Plant 4a (Internal No. B24) ⁽²⁾
Waste gas	NOx 100 mg/m ³ (estimated value) CO 10 mg/m ³ (estimated value). Total C 12 mg/m ³ (estimated value)	SO ₂ 35 mg/m ³ . NOx 80 - 140 mg/m ³ (80 mg/m ³ with SCR, 5 mg/m ³ NH ₃) CO 100 mg/m ³ Total C 10 mg/m ³ Dust 5 mg/m ³
Waste-water	Tributary stream 1: Waste water (with no pre-treatment) = 40 m ³ /h with COD of 150 mg/l (0.12 kg/t) Tributary stream 2: Waste water (after pre treatment and before final treatment) = 8.5 m ³ /h with COD of 1000 mg/l (0.17 kg/t) Total waste water (i.e. sum of streams 1 and 2) before final treatment = 0.95 m ³ /t with COD of 300 mg/l (0.28 kg/t)	Process waste water <u>before treatment</u> : Amount = 170 m ³ /h (~ 2 m ³ /t product) COD < 500 mg/l (<1.0 kg/t) BOD < 200 mg/l (< 0.4 kg/t) Chloride <1000 mg/l (< 2.0 kg/t)
Solid wastes	Wastes for re-use: 48 tpa coke, crack oil and other sludge from the petrochemical plant (thermal combustion), 156 m ³ /a metal containing used catalysts (regeneration) Waste for combustion: 1.5 tpa organic polymers, 30 tpa lubricating oils, 20 tpa triethylerylglycol	<u>Further used</u> : 5 –20 tpa metal containing used catalysts (regeneration), every 2 to 5 years. <u>Removal in a combustion plant</u> : 1200 tpa sludge from API, 120 tpa distillation residue, 100 tpa sludge from tank cleaning, 60 tpa compressor condensate, 10 /a lubricating oils, 5 tpa methanol, 2 tpa polymers, 1 tpa glycol.
Energy	<u>Input</u> : Steam (at 105bar) 15 t/h, Steam (at 30bar) 10 t/h, Steam (at 5bar) 15 t/h Electric power 12MW. <u>Output</u> : Steam (at 5 bar) 5 t/h	<u>Output</u> : 100 t/h high pressure steam
Auxiliary materials	<u>Input</u> : 40 t/h process water, 10000 t/h cooling water, 5 t/h raw water, 1500 Nm ³ /h N ₂ , 1500 Nm ³ /h regulating air, 1000 Nm ³ /h pressure air. <u>Output</u> : 10 t/h process water.	
Note 1: Production capacity: 550 kt/yr ethylene, 400 kt/yr propylene, 230 kt/yr C ₄ hydrocarbons, 580 kt/yr gasoline, 150 kt/yr medium crack oil, 430 kt/yr heating gas.		
Note 2: Production capacity: 720 kt/yr ethylene		

Table 7.14: Emission / consumption data for German steam crackers [UBA (Germany), 2000 #91]

7.3.6.3 Sweden

A Swedish plant with a capacity of 400 kpta reports 1998 consumptions of 11750 TJ fuel, 310 GWh electricity and 1168 kt/yr feedstock (naphtha, propane and butane) for a total production of 1165 kt/yr ethylene, propene, MTBE and some heavier fractions [SEPA, 2000 #76]. Emissions and discharges were not available per production line, but total values are given in Table 7.15. Although not quantified, start-up and shutdown emissions were considered minor in relation to the emissions during the whole operation period. The facility is normally operated for five years between shutdown/maintenance periods.

	Total 1998 emission (tonnes) ⁽²⁾	Specific emission (kg/tonne feedstock) ⁽⁵⁾
VOC	573 ⁽¹⁾⁽⁴⁾	0.49
NO _x	344 ⁽³⁾	0.29
SO ₂	<1	
CO ₂	600000	1.05
Dust	25	0.02
Oil	1.8	0.0015
Phenol	0.019	1.6 x 10 ⁻⁵
Total N	3.2	0.0027
Total P	0.45	0.00039

1. VOC estimated from trace gas measurements (SF₆).
2. Determined from measurement and calculation (all data from accredited laboratory)
3. NO_x Emission is less than half of the figure eleven years ago
4. VOC emission is about 40 % of the figure in 1988.
5. All but 3 kt of the feedstock converted to products (406 kt ethylene, 212 kt propene, 31 kt MTBE) so figures approximate very closely to 'per tonne of product'.

Table 7.15: 1998 emissions from a Swedish ethylene cracker
[SEPA, 2000 #76]

7.3.6.4 World Bank

A typical naphtha cracker, producing 500 kt/yr ethylene, on a petrochemical complex may release 2500 tpa of alkenes (propylenes and alkenes). Boilers, process heaters, flares and other process equipment (e.g. catalyst regenerators) release particulates, CO, NO_x (200 tpa), SO_x (600 tpa). VOC emissions range from 0.6 - 10 kg/tonne ethylene (VOC composition is 75 % alkanes, 20 % unsaturated hydrocarbons, about half of which is ethylene, and 5 % aromatics). The waste water flow from this typical naphtha cracker would be 15 m³/hour containing BOD (100 mg/l), COD (1500 - 1600 mg/l), suspended solids (100 - 400 mg/l), oil & grease (30 - 600 mg/l), phenol (200 mg/l) and benzene (100 mg/l) [World Bank, 1998 #99].

7.4 Techniques to consider in the determination of BAT

Only a limited number of the unit processes and unit operations that are used in steam cracking installations give rise to emissions since the very nature of the operation, involving hazardous, flammable and sometimes toxic volatile hydrocarbons at high pressures, requires containment. Prevention and control techniques are considered below for those unit operations that may cause emissions [CEFIC, 2000 #111].

7.4.1 Alternative processes

Companies constantly seek to broaden the raw material base for crackers by employing higher boiling fractions as feed (e.g. crude or residual oil) and this has prompted research into alternative processes. A few are in commercial operation, but they have issues with by-product utilisation and high operating costs. For example, UCC and Chiyoda have developed an Advanced Cracking Reactor (ACR) based on Kureha Chem. Ind. Technology [Weissmehl & Arpe, 1993 #59]. The ACR takes various heavy feedstocks, including those containing sulphur, for cracking at 2000 °C and 3.5 bar in a ceramic-lined reactor in the presence of combustion gases from process fuel and steam. Substantially more ethylene is obtained (e.g. 38 % w/w with a naphtha feed) than with conventional technology.

Lurgi have also developed a process where crude oil preheated to 340 °C is injected together with steam into a bed of hot sand in a fluidised bed reactor. Temperatures reach 1300 - 1550 °C within 0.3 - 0.5 seconds. The sand is continuously removed and any coke burnt off before the sand is recycled to the reactor [Wells, 1991 #60].

Philips Petroleum have a 'Triolefin' process for the disproportionation of propylene to ethylene and butylene [Wells, 1991 #60]. A demethanised propylene-propane stream is reacted at 7 bar and 360 - 450 °C over a catalyst (based on oxides of molybdenum, cobalt, tungsten or rhenium). The process gases are fractionated to recover ethylene and butenes, with the recycle of propane. The propylene conversion per pass is about 40 %, and the overall yield is 95 %.

India, Brazil, Sweden and China have produced ethylene from the catalytic dehydrogenation (dehydration) of ethanol (that may have been produced by fermentation of biomass [Weissermel & Arpe, 1993 #59] [Wells, 1991 #60]. Vaporised ethanol is passed over a fixed bed of activated alumina and phosphoric acid (or alumina and zinc oxide) at 296 - 315 °C. Heat for the endothermic reaction is provided by vapour condensation. Careful temperature control is required to minimise the formation of by-product acetaldehyde or ether. Process gases are quenched, water washed and caustic scrubbed, before drying, compression and activated carbon purification. There are waste water issues with this process. The overall yield is 94 %.

In South Africa, SASOL have derived cracking feedstock from coal-gasification and the Fischer-Tropsch process is used to produce ethylene [Wells, 1991 #60]. The ethylene process uses a promoted iron catalyst in a recycled fluid bed operating at 150 - 450 bar. Significant amounts of methane are formed in addition to light olefins and gasoline. This process is only economic if cheap coal is available.

The metathesis (disproportionation) of olefins can be used if the propylene demand increases quicker than the need of ethylene. Metathesis involves the exchange of alkylidene groups between two olefins. The simplest example is the reaction of two mols of propene to form one mol ethylene and one mol butene (mainly 2-butene). The reaction catalysts are generally based on molybdenum, tungsten or rhenium. With the metathesis process the products quantities can be adapted to the required ratio [Austria UBA, 2000 #133].

7.4.2 Air emissions

Pollution prevention and control techniques are considered for the six air emission sources shown in Table 7.16. Where possible, costs are given for applying prevention and control techniques to these sources, but it is often difficult to generalise since evaluation depends on many plant and site specific factors.

Source	Substance				
	NO _x	SO ₂	CO	VOC	Particulates
Gas-fired furnaces / steam superheaters	X	X	X	X	
Decoking vent gas	X	X	X	X	X
Flaring			X	X	X
Point source emissions				X	
Fugitive emissions				X	
Sour gas disposal		X			

Table 7.16: Main air emission sources and their components
[CEFIC, 2000 #111]

7.4.2.1 Gas-fired furnaces and steam-superheaters

Many of the techniques for emission prevention and control are described in the BREF for Large Combustion Plants but the following sections describe their specific use in Lower Olefin processes. Note that concentrations reported here are at normal pressure and temperature, 3 % oxygen in dry exhaust gas.

The most significant emissions to air from the steam cracking process result from the combustion of fuels in the cracking furnaces and steam-superheaters. These units are normally fired on fuel gas product (an internally generated residue gas of methane and hydrogen that is recycled from the separation unit of the cracker). The composition of the fuel gas varies depending on such factors as feedstock, the availability of natural gas and the degree of recovery of hydrogen or off-gases. Hydrogen in the fuel gas raises the flame temperature, which increases the level of NO_x produced by up to 25 % but reduces the carbon dioxide emissions. When considering the merits of extracting hydrogen, the overall energy and emission balance for the complex needs to be understood. Replacing the hydrogen/methane residue gas, with natural gas to reduce NO_x levels is not normally considered since the liberated hydrogen/methane mixture would be used as fuel elsewhere.

All emissions to air from cracking furnaces can be reduced by efficient design. Modern furnaces have thermal efficiencies in the range 92 - 95 %, and utilise extensive heat recovery systems. Heat recovery takes the form of high pressure steam generation facilities (the recovered steam being used to drive compressor turbines in the crackers' separation sections) and waste heat recovery from flue gas (for pre-heating of combustion air and boiler feedwater).

Steam cracking furnaces are generally proprietary designs developed by one of the following technology contractors: ABB Lummus; Kellogg, Brown & Root; Stone and Webster; Linde and Technip. No single design is environmentally superior to another and the selection of a particular vendor is more strongly influenced by installed cost, specific requirements to handle particular feedstocks and operating flexibility. It is not uncommon to have more than one vendor's furnace design on the same steam cracking plant.

The competitive nature of the business has led to significant design improvements in the last two decades, particularly with regard to feedstock conversion to the desired olefins products, and in terms of energy efficiency and operating performance. Metallurgical and mechanical improvements have also allowed much larger units to be introduced. Modern furnaces are typically capable of producing around 80 - 100 kt/yr ethylene, compared with only 20 - 25 kt/yr for units designed in the 1960's. Even larger units, of 150 - 200 kt/yr capacity, are being installed on new 'mega-olefins' plants of one million tonnes/annum ethylene capacity and above.

In addition to carbon dioxide (which is considered with energy efficiency in 7.4.5), the principal combustion products are NO_x, CO, volatile organic compounds (VOCs) and potentially SO₂. Factors affecting the overall emissions include:

- operating with conventional burners (highest NO_x), low-NO_x burners or SCR DeNO_x units (lowest NO_x)
- using high hydrogen fuel gas, fuel gas with variable composition and/or liquid fuels (increases NO_x)
- controlling the combustion by advanced (preferred) or conventional control systems (maximum thermal efficiency and minimum CO)
- purging gas streams via the furnaces (preferential disposal route)
- use of combustion air preheating or exhausted flue gases from gas turbines (improved thermal efficiency but increases NO_x)
- minimising flame temperature (can be by steam injection or recycling flue gas to reduce NO_x)
- burner turn-down (generally results in increased NO_x).

7.4.2.1.1 Nitrogen oxides

The level of NO_x is primarily determined by flame temperature, which is a function of the burner technology, the fuel gas composition, the furnace geometry, the excess oxygen and, to a lesser extent, on the ambient air temperature and humidity. Using conventional burners and firing natural gas, NO_x levels up to 250 mg/Nm³ of flue gas can be expected (for normal oxygen excess of 3 %).

With modern low NO_x burners (LNB), NO_x levels of 100 - 130 mg/Nm³ can be achieved [InfoMil, 2000 #83]. Ultra low NO_x (ULNB) burners are claimed to achieve levels as low as 75 - 100 mg/Nm³, depending on the concentration of hydrogen in the fuel and the required burner flexibility. LNB and ULNB use staged air or fuel addition to reduce the residence time and peak temperature within the burner, thus reducing NO_x production. For new installations, there is unlikely to be a differential cost in specifying low NO_x burners and these units have similar efficiencies to conventional burners (but require more maintenance). For existing furnaces, the geometry and the use of a large number of sidewall burners makes replacement with LNB expensive and often impracticable as it typically involves casing modifications. Most cracker operators now have experience with LNB and the CEFIC survey identified 13 plants with 100 % application of LNB. A further 13 have LNB on some of their furnaces [CEFIC, 2000 #110]. The installed cost for retrofitting LNB in existing furnaces therefore lies between the cost of a simple replacement of burners and ultimately the cost of a new furnace.

Lower NO_x levels can be achieved through the application of Selective Catalytic Reduction (SCR), sometimes referred to as De-NO_x technology. SCR involves the reduction of oxides of nitrogen with ammonia to produce nitrogen and water. The reaction takes place by contacting the flue gas and ammonia over a suitable catalyst located in the convection bank or stack of the furnaces. Ammonia injection must be carefully controlled to ensure that only the stoichiometric amount is injected, since any excess results in ammonia emission. With SCR, NO_x emissions can be reduced by up to 90 %, or to around 20 mg/Nm³ for natural gas, with NH₃ slippage below 5 mg/Nm³. However, there are many factors that influence the performance. The primary variable affecting NO_x reduction is temperature, and that for a given catalyst, the optimum performance occurs within +/- 10 °C of its design temperature [USEPA, 1993 #136]. Below this temperature, catalyst activity is greatly reduced, allowing unreacted ammonia slippage. Equally important is that at temperatures above 450 °C ammonia is itself oxidised to NO_x.

Typical cracking furnaces are designed to accept a range of feedstocks (for example naphtha, naphtha/C₄s or LPGs); are required to operate at different rates (decoking mode, steam stand-by mode and at hydrocarbon feed-rates between 75 - 110 % of design); and to accept a range of fuel gas compositions. When using feeds of high hydrogen fuel gas (the normal fuel source for steam crackers) the NO_x levels are reported as being between 15 - 50 % higher than for natural gas [USEPA, 1993 #136]. All of these factors influence the bed temperature and/or space velocity over the bed, with consequential reduction in performance.

State of the art cracking furnaces with SCR have been designed, and have been proven to achieve NO_x emissions of 60 - 80 mg/Nm³, with an ammonia slippage below 5 mg/Nm³. However, over the operating cycle of a furnace, there is evidence to indicate a deterioration in performance of the SCR units which will lead to higher NO_x emissions and/or higher ammonia slippage. This consistently achievable range is therefore similar to the performance expected from ultra low-NO_x burner technology. SCR also requires equipment to transport and handle the several hundred tonnes per annum of ammonia that is required for NO_x abatement on an average sized steam cracker.

The CEFIC survey identified that there are no applications of Non-Catalytic (thermal) DeNO_x (SNCR) systems on steam cracking plants because of the high reaction temperature required. However, three plants have experience with Selective Catalytic Reduction (SCR), one for the complete furnace section [CEFIC, 2000 #110].

In the CEFIC survey, the five crackers reporting the lowest NO_x emission levels (61 - 87 mg/Nm³) were equipped with LNB, SCR or a combination of both. Conversely, the five furnaces reporting the highest NO_x emissions (168 - 250 mg/Nm³) included two which are fully equipped with LNB, and two partially. Low NO_x burners do not always guarantee low NO_x emissions on their own and, in many cases, optimal results are only achieved when burner chambers are modified as well.

Table 7.17 gives the costs of techniques for NO_x emission reduction in cracking furnaces. SCR is a relatively expensive process and the USEPA has quoted a 1991 installed cost of \$2.5 million for a new furnace on a medium-sized model furnace of 84 MMBTU/h (approximately 40 - 50 kt/yr ethylene). SCR requires provision for mechanical draught, which increases the installed cost of retrofitting to existing natural draught furnaces. Operating costs are \$121k/annum for this model furnace, giving an annualised total cost of \$452k [CEFIC, 2000 #111].

Technique	Achievable NO _x Levels (mg/Nm ³)	Extra cost ⁽¹⁾⁽³⁾ (million Euros)	Abatement cost ⁽¹⁾ (Euro/tonne NO _x)
Low NO _x burners	100 - 130 ⁽²⁾		
Ultra low NO _x burners	75 - 100 ⁽²⁾		
Catalytic de-NO _x (SCR)	60 - 80 ⁽⁴⁾	2.5	11000

(1) Costs are based on data in [USEPA, 1993 #136] and assuming \$1 = Euro 1. Costs have not been escalated from the 1991 base year, or corrected for furnace size, since there are many parameters that influence the latter.
(2) In the case of LNB/ULNB, increased hydrogen in the fuel may add up to 25 % to the NO_x emissions
(3) For new furnaces, the base design assumes LNB or ULNB burners without SCR. For retrofitting, the base design assumes conventional burners and no SCR.
(4) The best performance achieved under the full range of operating conditions.

Table 7.17: Costs of NO_x reduction techniques for new and retrofitted furnaces [CEFIC, 2000 #111]

7.4.2.1.2 Carbon monoxide

CO emissions correlate with the excess of oxygen in the flue gas. For efficiency reasons it is desirable to keep the excess oxygen as low as possible, but in a low oxygen environment the CO level increases. Low CO emissions and high efficiencies are simultaneously achieved by using advanced combustion control to give efficient fuelling in well-designed burners and furnace fireboxes. Advanced combustion control is usually included as part of an overall furnace control package, covering throughput, severity, thermal efficiency and operating constraints. Normally, this includes flue gas carbon monoxide and oxygen analysers linked to the combustion control devices (e.g. furnace draught control). Advanced combustion control can achieve CO levels of 0 - 20 mg/m³. The extra capital cost is 0.1 to 0.2 million Euros [CEFIC, 2000 #111]. Since the CO analyser is linked to the advanced combustion control system of the furnace, it is difficult to separate pay-back for the incremental investment from the significant payback benefit arising from the overall improved control of the furnace.

7.4.2.1.3 Volatile organic compounds (VOCs)

Emissions of VOCs from furnaces are negligible. In some cases the cracking furnaces are designed to dispose of regeneration gas purge streams and / or other off-gases, since burning in the furnace offers a more effective disposal method than other options. The combustion efficiency is nearly 100 %.

7.4.2.1.4 Sulphur dioxide

SO₂ emissions from gas-fired furnaces are usually negligible as the fuel is predominantly a recycled gas or natural gas, both of which are virtually sulphur-free.

7.4.2.2 Decoking vent gas

During the cracking process, the furnace coils become progressively fouled with carbon. The furnaces therefore need to be decoked on a routine basis, which may be between 14 and 100 days, depending on feedstocks, design and desired operating severity. Decokes are normally carried out 'on-line', by using the furnace for heating and by routing steam or air/steam mixtures through the coils to burn the carbon to carbon dioxide. The vent gas may be discharged to:

- a common decoke drum to serve a number of furnaces, equipped with wet dedusting (water spray tower, water scrubber) or dry dedusting (cyclones, bag filters), or
- individual decoke drums for each furnace, as above, or
- provision to route decoking air/steam mix into the furnace firebox (with adequate residence time to ensure complete combustion of the coke particles).

The installation of a decoke drum with particulates abatement is relatively straightforward, while the connection to a firebox needs at least a modification of the masonry, and possibly the relocation of some burners. Any of the techniques can achieve low levels of particulate emissions.

The decoking operation is the principle potential source for particulates emission. Measurement can be difficult, since the operation is intermittent (typically 3 % of time) and the level of potential emissions changes significantly from the start of the decoke cycle (when it is highest) to the end (lowest). Using the German TA-Luft method and depending on the effectiveness of the particulate elimination design, the achievable particulate concentration in the vent gas could be 10 mg/Nm³ with a fabric filter (below 1 mg/Nm³ with an improved compact filter) or 5 - 75 mg/Nm³ with electrostatic precipitators [EIPPCB, Draft #48]. However, in practice the intermittent nature of the vents and fabric filter condensation / plugging (due to the large amounts of steam) usually mean that units operate with cyclones and achieve an emission of less than 50 mg/Nm³.

Higher than normal concentrations of carbon monoxide may also be encountered during the early stages of decoking, since the air supply has to be carefully controlled to avoid excessive temperatures. However, carbon monoxide levels are rarely monitored over the decoke cycle as the controlling parameters are tube metal temperature and coil exit temperature. For typical configurations and feedstocks, the furnace is in decoke mode for approximately 3 % of the time, contributing only a small time-weighted increase to the overall average carbon monoxide emissions.

The rate of coking is mitigated by the addition of inhibitor chemicals that generally reduce the catalytic activity of the nickel alloy coil materials. Sulphur-based inhibitors, such as dimethyl sulphide and dimethyl disulphide, are commonly used. Non-sulphur inhibitors are under development but as yet are not generally proven or available.

Surface coating preparations for furnace coils are also being developed, and are under trial with a number of world-wide producers, including some in Europe. The principle benefit of such coatings is to allow increased coil exit temperatures (and therefore increased conversion) over the furnace cycle, or to extend this cycle to reduce non-productive furnace time.

7.4.2.3 Flaring

Low pressure gas originating in the cracking process is collected in a purge gas system and routed to a flare and/or recovered by suitable means for use as a fuel supplement. Emergency situations may lead to the need for rapid and safe disposal of any hydrocarbons or hydrogen that cannot be recovered in the process. This is particularly the case in the event of unplanned shutdowns. The primary role of the flare system is therefore safety. However, in the majority of plants any off-specification products or intermediates are also routed to the flare system since it is difficult to store these highly volatile or gaseous compounds for later recovery. For the same reason, the cracker products are often routed directly to consumer plants without passing through transfer storage.

There are two types of flare: 'elevated' and 'ground'. The choice between ground and elevated flares (or a combination of both) will depend on location and proximity to other plants and equipment and, in particular, requires recognition of heat radiation, noise nuisance impact and light pollution for the neighbourhood.

Generally, ground ('trickle') flares are generally less obtrusive and have a higher incineration efficiency (>99 %) than elevated flares (>98 %) but are limited in capacity and are rarely suitable for emergency disposal. This is because the combustion efficiency of ground flares is dependent on maintaining a high temperature at the burners, which therefore have to be commissioned sequentially to ensure complete hydrocarbon destruction. Ground flares are therefore relatively costly to operate and maintain. Ground flares are used for the disposal of small quantities of purge gas on a continuous basis.

Elevated flares, on the other hand, are simple in design and provide a safe disposal route for hydrocarbons, but are highly visible. Combustion performance is improved by the use of steam injection to aid fuel/air mixing, but this may result in noise nuisance if steam use is excessive.

Flares are required to operate over a very wide range of conditions. Flow rates range from very low (< 1 % of design) and may contain substantial quantities of inert gas (for example when undertaking maintenance activity), to maximum relief load (typically several hundred tonnes/hour). Combustion efficiency over this very wide range of operating conditions is difficult to determine or monitor except by ensuring smoke elimination whenever possible. In some countries, the application of recognised opacity standards (e.g. Ringlemann (BS 2742) 80 %) is used to define the level of smoky flaring beyond which a regulator must be informed. The flaring of light hydrocarbons from lower olefin processes does not normally give rise to visible smoke formation, especially when assisted with steam.

Any loss of hydrocarbon to flare represents potential value loss to the operator. Considerable steps are therefore taken to minimise flaring, both through equipment design and reliability, and through the use of high-integrity emergency shutdown systems, to avoid the need to divert material to flare. Minimising emissions from flares therefore covers two main aspects:

1. Minimising unburned hydrocarbons, smoke and where possible minimising noise, through:

- the use of smokeless flare design
- the use of steam injection to assist air/hydrocarbon mixing (this may be automatically ratio controlled to the quantity of hydrocarbons being flared)
- the use of video or IR monitoring of flare tip (often with time-lapse recording to allow post-event analysis).

Elevated flares are typically capable of smokeless operation up to around one-third of maximum rated capacity. The steam supply needed to sustain this performance should be sourced from a secure location, such as a utility centre within the plant complex.

2. Minimising the quantity flared, through:

- sound engineering design, with high equipment reliability (including, for example, design for containment of refrigeration inventories in the event of a compressor trip)
- use of well trained technicians and engineers with regular competency monitoring
- application of recognised maintenance management and condition monitoring programmes to assure high levels of equipment availability (e.g. on-line condition monitoring for major compressors)
- use of high integrity trip systems to reduce the possibility of spurious trips and minimise the impact of genuine failures
- use of flare gas recovery systems to recycle flare gas to the process or fuel systems (usually only possible for small quantities of material).

Plant design has evolved to minimise the requirement to flare on start-up because of the perceived public nuisance that such an activity creates. This involves the use of several internal recycle loops to allow various streams to be returned to the furnace area or fuel systems whilst the intermediate stream compositions are equilibrating. This procedure can often increase the time taken to achieve on-specification operation and may not always reduce the total emissions to air. Additional information on flaring is provided in Annex III: Flare Systems.

7.4.2.4 Point source emissions

Atmospheric vents. In modern plants all possible vents from the process are collected in a closed system and routed to a suitable purge gas system. However, in limited instances, even the very small back-pressure imposed by the purge gas system cannot be tolerated and vents may need to be routed to atmosphere for safety reasons. Direct hydrocarbon vents to atmosphere should be avoided as far as practicable but where this is not possible VOC emissions may be reduced by such techniques as knock-out drums (to recover hydrocarbons), activated carbon adsorption or scrubbing.

Rotating equipment. All rotating equipment poses a potential emission source through seals. It is common to use double or tandem mechanical sealing arrangements on duties where loss of containment not only presents an environmental risk but also a safety hazard. Seals may be designed for a positive flow of harmless material into the process stream or for safe disposal (usually via the purge gas system) of hydrocarbon from the inner seal chamber, the outboard seal ensuring no material passes to atmosphere. For very large rotating equipment, such as multistage centrifugal compressors, circulating oil or gas seal systems are provided, with in-built facilities for recovering contaminated seal gas/seal oil which is recycled to the process.

Sample points. Sample points are a potential source of atmospheric emissions. The need to break containment in order to obtain samples can be reduced by using closed, on-line automated sampling techniques. On-line analysers use fast-loop sampling arrangements so the only emission results from venting the extremely small quantity of material that is injected into the analyser (a few millilitres per hour). Where manual sampling is required, emissions can be minimised by the use of closed sample loop points which employ the same technique as on-line sampling but allow a suitable sample bomb to be connected/disconnected using quick release couplings.

Intermediate storage. Only a relatively few vessels are at atmospheric pressure and need to be vented to flares (e.g. day tanks for liquid feeds such as naphtha and some intermediate gasoline-type products). Where the stored material contains a high concentration of toxic compounds such as benzene, vent recovery systems may be provided to allow displaced vapour to be recovered to another tank during charging/discharging. A good practice to reduce emissions is the use of nitrogen purging/blanketing to minimise breathing losses, often with vent filters of activated carbon (or similar material). Floating roof tanks are not normally found in ethylene plants.

7.4.2.5 Fugitive emissions

Fugitive emissions can be minimised by using the equipment design, fugitive loss assessment / measurement, and equipment monitoring / maintenance techniques as described in 5.3.1.3.

7.4.2.6 Sour gas disposal

The presence of low levels of sulphur in the feed to cracking furnaces is known to inhibit coke formation and therefore extend the operating cycles of the unit. In some cases, sulphur is present in the purchased feedstock, but it is also common to inject sulphur (usually as dimethyl disulphide or dimethyl sulphide) up to approximately 100 ppm in the furnace feed. Carbon dioxide may also be present in the feed at low concentrations (particularly with gas feedstocks), and is in any event produced in the steam cracking process.

The acid gases produced in the furnace have to be removed before the mixed cracked gas stream enters the final stage(s) of compression and cryogenic separation and this is accomplished by scrubbing with caustic (sometimes preceded by amine wash). The so called spent caustic effluent (which contains sodium carbonate, sodium bicarbonate and sodium sulphide) may be disposed of to the aqueous effluent through acidification (neutralisation). However, this may generate a gaseous stream containing hydrogen sulphide if the spent caustic is not oxidised or the neutralised mixture stripped of hydrogen sulphide (to a closed system) beforehand. Spent caustic effluent may also be treated by wet air oxidation. Wet air oxidation produces a waste water containing sulphates (and some thiosulphates) and an oxidation air stream that has to be treated in an afterburner to destroy the hydrocarbons removed from the spent caustic during the oxidation step.

Alternatively, the stream can be incinerated, liberating SO₂ emissions to air. If incineration is used, and with a liquid feedstock containing 100 ppm sulphur, a specific emission level of about 0.6 kg SO₂/t ethylene can be expected. The relatively low level of SO₂ produced does not normally justify the provision of a dedicated incinerator for the spent caustic effluent. However, where a suitable incinerator already exists on-site it provides an alternative disposal route (especially when local conditions impose onerous constraints on effluent discharges).

7.4.2.7 Costs

Table 7.18 gives the emission factors, investment costs, operating costs and abatement efficiencies for three sizes of steam cracker producing ethylene from naphtha feed. Data is given for different combinations of primary and secondary control techniques.

The primary measures are:

- A. basic fugitive emission control (annual monitoring, repair and replacement of valves, pumps, compressors, pressure relief vents and open-ended lines)
- B. restrictive fugitive emission control (more frequent monitoring, repair and replacement - semi-annual or quarterly – for a higher share of leaking components)
- C. stringent fugitive emission control (intense monitoring, repair and replacement – monthly for higher percentage of leaking components –includes monitoring of flanges).

The secondary measures are:

1. intermittent emission reduction by a flare
2. as above, plus emission reduction from process vent, sampling lines and process analysers by piping to charge gas compressor, combustion chamber or carbon adsorption.

Steam cracker production capacity	Primary control measure	Secondary control measure	NMVOC emissions (g/t product)	Investment (ECU) ⁽²⁾	Operating Costs (ECU/a)	Abatement Efficiency (%)
Small installation (150 kpta ethylene)	A	1	3575	0	0	0
	B	1	1415	0 ⁽¹⁾	190000	60
	B	2	893	330000	342800	75
	C	1	1247	0 ⁽¹⁾	600000	65
	C	2	725	330000	752800	80
Medium installation (300 kpta ethylene)	A	1	3575	0	0	0
	B	1	1415	0 ⁽¹⁾	285000	60
	B	2	893	385000	563300	75
	C	1	1247	0 ⁽¹⁾	765000	65
	C	2	725	385000	1043300	80
Large installation (600 kpta ethylene)	A	1	3575			
	B	1	1415	0 ⁽¹⁾	380000	60
	B	2	893	450000	887500	75
	C	1	1247	0 ⁽¹⁾	930000	65
	C	2	725	450000	1437500	80

1. Investments for process modifications are assumed to be negligible, if the technology switch occurs in the course of an autonomous technology change.

2. All cost data scaled onto 1995 level. Capacities and volume flows referring to reference installation category.

Table 7.18: Steam cracker emission factors, investments, operating costs and abatement efficiencies [Rentz, 1999 #114]

7.4.3 Water emissions

7.4.3.1 Process water

Dilution steam generation systems are used to recycle the majority of the contaminated condensate from the furnaces. These units typically include a gasoline wash system to extract heavy hydrocarbons, a coalescer/phase separation system, a stripping tower to remove light hydrocarbons, and a regeneration column or regeneration exchangers where the partially cleaned water is reboiled and returned to the furnaces. Hydrocarbons removed in the process are retained within the plant and join the gasoline and/or fuel oil product streams. Dilution steam generation systems can considerably reduce the requirement for boiler feed water on a plant since the condensate from the 'clean' steam used to re-boil the process water can be recovered. Dilution Steam Generation gives the additional advantage of reducing significantly the quantity of process water that requires to be treated, whilst at the same time lowering the hydrocarbon and phenol loading.

A periodic purge or blowdown (typically 10 % of the total dilution steam flow) is taken from the system to prevent contaminant build-up. Treatment of the purge involves pH adjustment (if required), further oil separation, in either corrugated plate or API separators, and may include further oil separation by air-flotation before discharge to a central WWTP.

On older units, it is more typical for the entire dilution steam required in the process to be purged to effluent, sometimes following a simple light-hydrocarbons stripping step. Retrofitting a dilution steam generation system on an existing cracker is extremely difficult, requiring major modifications to the cracker's energy recovery systems. The installation of an oil separator on an existing cracker is generally straightforward.

7.4.3.2 Spent caustic stream

Spent caustic can be sold for sodium sulphide content or recovery of the cresols, but more frequently there is a need for treatment involving a combination of the following steps:

Pre-treatment:

- solvent washing or liquid-liquid extraction for polymers and polymer precursors
- liquid-liquid settler and/or coalescer for removing the free liquid gasoline phase (which is then recycled to the process)
- stripping with steam or methane for hydrocarbons (including benzene) removal and subsequent recovery, although this liberates hydrogen sulphide and mercaptans that require treatment.

Process-step (oxidation):

- neutralisation with a strong acid (sulphuric acid) or with carbon dioxide liberates a H₂S/CO₂ gas stream that is combusted in a sour gas flare or incinerator. This is the simplest treatment and gives sulphur dioxide emissions of 60 to 450 g SO₂/t ethylene (depending on the feedstock sulphur content). In some cases (6 in the CEFIC survey) the hydrogen sulphide off-gas may be recovered in a Claus unit for sulphur recovery. This results in no sulphur dioxide emission but is only possible when the cracker is close to an oil refinery or a natural gas treatment plant. The resulting aqueous stream contains the salts sodium carbonate, sodium sulphate and in some cases, if the oxidation is incomplete, small quantities of sodium thiosulphate and sodium bicarbonate
- neutralisation with acid gas or flue gas will partition the phenols into a buoyant oily phase for further treatment [EC DGXI, 1993 #8]
- oxidation (wet air or catalytic wet air or ozone) fully oxidises the content of carbon and sulphides/mercaptans before the neutralisation stage (significantly reducing or even eliminating any H₂S liberation). The resulting sulphate discharge is unavoidable as it derives from sulphur in the raw materials.

Post treatment (polishing):

- biological treatment with other site waste streams as a final step
- chemical oxidation (with hydrogen peroxide).

A CEFIC survey elicited 36 responses on the treatment of spent caustic. Acid treatment is used in 13 cases and (wet) air oxidation in 9 cases. The solution is sold in 5 cases and in 9 cases the solution is treated in a treatment facility shared with other plants [CEFIC, 2000 #110].

7.4.3.3 Amine wash

Heavy feedstocks create a higher load of hydrogen sulphide and mercaptans and it is more economic to pre-scrub with an amine solution in order to reduce the amount of caustic required. The amine absorber uses mono or diethanolamines to convert the hydrogen sulphide into a salt. The used amine solution can be regenerated by steam stripping to remove hydrogen sulphide. Some of the ethanolamines are converted into a non-regenerable salt by reaction with carbon dioxide and the salt concentration is controlled by a bleed. Caustic washing usually follows amine washing to remove residual carbon dioxide and mercaptans [EC DGXI, 1993 #8].

7.4.3.4 Green oil

The C₂ overhead stream from the de-ethaniser contains acetylene that is catalytically hydrogenated to ethylene and ethane. However, the reaction also produces a C₂ polymerisation product known as 'green oil' that contains a low concentration of multi-ring aromatics (e.g. anthracene, chrysene, carbazole). Green oil can be recycled into the process (e.g. into the primary fractionator for recovery as a component of fuel oil) or can be burned directly to recover steam / energy [EC DGXI, 1993 #8].

7.4.3.5 Other effluents

Cooling water recirculation can reduce water use and hence the quantity of effluent. Cooling waters are relatively clean but they will contain small amounts of oil, inorganic salts, hypochlorite and sulphuric acid. Cooling water effluent should be segregated so that only the necessary treatment is administered [EC DGXI, 1993 #8].

Surface run-off may contain oil and hydrocarbons that will require separation.

Storage and loading may generate effluents. Attention is paid to the minimisation of spillage and the installation of oil/water separators prior to central waste treatment.

7.4.4 Solid wastes

Generally, the steam cracking process results in only small quantities of solid waste, mainly organic sludges, spent catalysts, spent desiccants, and coke. Each waste is treated on a case by case basis, and may be recycled, reclaimed or re-used after treatment. Alternatively they may be incinerated or landfilled; generally offsite by third parties.

Molecular sieve **desiccants** and acetylene hydrogenation **catalysts** may be regenerated and re-used, although they will require eventual disposal to landfill.

The CEFIC survey [CEFIC, 2000 #110] reported 27 respondents disposing of **organic sludges** by incineration, 18 by landfill, with both approaches often combined. Some wastes are also processed by off-site, specialist contractors to recover valuable light fractions, or for use as additives to construction materials.

The generation of **coke** is unavoidable, as furnaces have to be periodically de-carbonised. Coke is mainly disposed of by incineration but some producers use landfill, and one producer is able to send the coke to a delayed coker in a neighbouring refinery.

7.4.5 Energy

Carbon dioxide emissions vary with the cracker fuel consumption and this can be optimised by recovering heat where possible. Emissions are also affected by fuel type but this provides little opportunity for modification as it is determined by the desired products and the level of process integration [CEFIC, 2000 #111].

Energy efficiency improvements often involve the replacement or major modification of key items of equipment such as the furnaces, compressors and distillation towers. The decision to undertake such changes is based on economic factors, both in terms of the investment costs and potential savings. The cost of fuel has a major bearing on these decisions [CEFIC, 1999 #54].

In the early 1970's the increases in crude oil price increased both the cost of petrochemical feedstocks and fuels, and created an increasingly competitive environment. This prompted process modifications to increase olefin yields (by designing cracking heaters to operate more selectively) and to reduce the energy consumption of ethylene plants. About 60 % of energy reductions since the 1970s have resulted from improvements in the cracking / quench sections, with the balance coming from improvements in the recovery section. Some notable improvements have been:

- Cracking Section
 - more selective coils giving higher ethylene yield
 - improved TLEs with higher heat recovery at lower pressure drop
 - increased overall fuel efficiency (typically 92 - 94 %)
 - secondary TLEs for gas crackers.

- Cracked Gas Cooling and Compression
 - higher gasoline fractionator bottom temperature
 - improved use of heat available in quench water
 - lower pressure drops in compressor system inter-stages
 - use of gas turbine exhaust as cracking heater preheated air.
- Cold Fractionation and Refrigeration Systems
 - additional expander on gas de-methaniser to optimise feed pre-cooling
 - addition of side re-boilers to provide more efficient cold recuperation
 - use of extended surface exchangers to improve heat transfer performance.
- Utility Systems
 - addition of gas turbine/electric generator
 - optimisation of steam and power balance
 - improved compressor/driver efficiencies.

7.4.6 Noise minimisation, atmospheric monitoring and reporting

Ethylene plants contain equipment that produces noise emission in the range above 85 dBA. These are the burners at the furnaces and the large compressors. Noise abatement measures (e.g. silencers for burners, hoods for compressors) may be required to bring the overall emissions into the range below 85 dBA. Other sources of noise emission can be high velocities in piping or vibrations. The detection of the source in this case is sometimes very difficult and requires much expertise [Ullmann, 1998 #80].

7.5 Best Available Techniques

As explained in Chapter 6, BAT for a particular LVOC process is determined by considering the three levels of BAT in the following order of precedence: illustrative process BAT (where it exists); LVOC Generic BAT; and finally any relevant Horizontal BAT. The following techniques are BAT for the illustrative process of Lower Olefins production.

7.5.1 Process selection

The steam cracking process is the only large-scale process currently available for production of the full range of lower olefins (ethylene, propylene and butadiene) and is generally BAT. However, this does not preclude the recovery of light olefins from refinery off-gases (usually in small quantities) or propylene production by the dehydrogenation of propane. Refinery light olefins are invariably fed to a steam cracker for further separation.

There are many variations of plant configuration to accommodate the feedstock selection and desired products, but all steam crackers include the common components of:

- a furnace section (in which suitable feedstocks are cracked in the presence of steam)
- a primary fractionation and quench system (in which heavy hydrocarbons and water are removed)
- a compression section (including acid gas removal) and
- a fractionation section at both cryogenic and moderate temperatures (in which the various products are separated and purified).

Feedstocks for the steam cracker process may include ethane, LPG, naphtha, gas-oil and vacuum gas-oil. The selected feedstock largely determines the range and quantities of the ethylene co-products (namely propylene, butadiene, butenes, aromatics (benzene, toluene),

gasoline and fuel oil). However, there are significant differences between the designs for gas and liquid crackers, and it is rarely possible to crack more than a limited amount of, for example LPG, on a plant designed for naphtha, and *vice versa*. Ethane produces the highest yield of ethylene but very low yields of recoverable co-products.

Feedstock selection is influenced by many factors. Only a very small number of crackers in Europe have access to ethane, which is normally extracted from natural gas. Naphtha is readily available and relatively easy to transport, and so supports the great majority of European steam crackers. Gas-oil and vacuum gas-oil crackers need to be integrated with an oil refinery and are therefore usually co-located. It is not possible to determine a BAT feedstock although emissions from plants using gas feedstock tend to be lower than from plants using naphtha or gas oil feedstock.

7.5.2 Plant design

By their nature, steam crackers are large plants utilising significant quantities of energy (15 to 50 GJ/t ethylene) to process highly flammable hydrocarbons at elevated pressures and temperatures. BAT for the design of steam crackers includes the following components:

- all equipment and piping systems are designed to ensure a **high level of containment** and to minimise fugitive emissions. This involves seal-less or double/tandem sealed machinery, low-loss valve packing, use of spiral-wound jointing materials, and minimum use of flange connections. Equipment that handles materials known to pose a health hazard (e.g. butadiene and benzene) shall be designed to limit the exposure risk to an acceptable level
- there is an **absence of hydrocarbon vents to atmosphere** for normal operation (all vent and drain points for equipment maintenance are capped or blanked)
- hydrocarbon **flare** collection system(s) are provided for the safe disposal of off-specification and purge streams. The requirement for flaring may be minimised through selection of appropriate equipment pressure rating. The flare design allows for complete combustion and smokeless operation over a wide range of flaring conditions
- highly integrated **energy recovery systems**, involving the use of multi-levels of energy, integrated with the aid of advanced pinch analysis to maximise recovery and reduce energy consumption
- design for extended periods of continuous operation between planned **overhauls** (5 year intervals are common). Considerations include philosophy for holding spare parts, on-line equipment condition monitoring, maintenance and operating strategies
- extensive automatic systems to allow **safe shutdown** of plant. Systems are often fully redundant, capable of on-line proof testing, and backed up against external power failure
- several techniques are employed to **minimise waste** at source by recycling and reprocessing streams within the plant, including inventories of equipment being taken out of service for maintenance, recovery of off-specification streams, and provision of dilution steam generation systems to minimise aqueous effluent volume
- segregated aqueous **effluent collection systems** are provided. This allows the effective treatment of process effluent water and potentially contaminated water from leaks and other sources prior to discharge with uncontaminated streams. Specific treatment facilities are required for the processing of the spent caustic stream. Sewer systems are made from corrosion resistant material and trapped to avoid emissions of volatile compounds
- only very limited facilities are provided within the steam cracker for the **storage** of the various intermediate streams, and the design of this equipment is in line with the features described above. Feedstock and product storage are usually provided outside the cracker battery limits.

7.5.3 Process control and operation

Effective process control systems are important to ensure stable and high yield operating conditions and good environmental performance. BAT for the control and operation systems of steam cracker processes includes the following elements:

- advanced control and on-line optimisation is used extensively in steam crackers. Plants utilise multi-variable control techniques incorporating on-line analysers, performance controls, constraint controls, etc., often with on-line optimisation for maximising asset utilisation and performance
- extensive use of permanent gas monitors, video surveillance and equipment health monitoring (such as on-line vibration monitoring) also provides early detection and warning of abnormal conditions, allowing appropriate action to be taken
- an environmental management programme covering, as a minimum:
 - regular inspection and instrument monitoring to detect leaks and fugitive emissions to atmosphere, water and ground, and appropriate repair programmes (LDAR programme)
 - environment monitoring in the surrounding community
 - health monitoring of staff
 - procedures for dealing with non-routine and abnormal events, to ensure that emissions associated with depressurising, emptying, purging and cleaning of equipment are treated before discharge.

7.5.4 Air emissions

The most important measures for controlling air emissions are based upon recycle and/or re-use techniques and these are BAT. Hydrocarbon waste streams may be used as fuel (for heat and steam generation), reprocessed within the installation, or recovered for sale. The extent of application of these options will depend on technical and economic considerations on each site.

7.5.4.1 Cracking furnaces

Cracking furnaces are usually gas fired, using natural gas or (more typically) produced residue gas (a mixture of methane and hydrogen). Emissions of SO₂ and particulates are extremely low or even negligible, and the application of appropriate combustion control minimises the emission of VOCs. Concentrations reported below are to be interpreted as 30 - 60 minute averages at normal pressure and temperature, 3 % oxygen in dry exhaust gas.

Control of NO_x emissions is important. For new furnaces, BAT is the use of Ultra Low NO_x burners (ULNBs) or, alternatively, the provision of a catalytic De-NO_x (SCR) system. For existing furnaces, the BAT decision will depend on the feasibility of installing ULNBs or SCR considering the plant design and layout.

Emissions from ethylene cracker stacks employing low NO_x burners can achieve (as an hourly average) 100 mg/m³ NO_x (as NO₂) and levels as low as 75 mg/m³ may be achieved with ultra low-NO_x burners. New plants equipped with catalytic de-NO_x equipment can achieve a NO_x emission level of 60 mg NO₂/m³. However, catalytic de-NO_x was noted to be expensive and the emissions level may be achievable by a combination of other techniques.

Catalytic de-NO_x may also give rise to ammonia emissions. In modern units, operating with new catalyst, the BAT-associated ammonia levels (as an hourly average) are < 5 mg/m³ at high NO_x reduction rates (> 80 %). However, catalyst activity declines with age and higher ammonia emissions may occur.

BAT for **carbon monoxide** emissions is the use of advanced combustion control schemes utilising feedback from continuous flue gas analysers, usually installed as a standard package alongside the normal combustion control systems.

Specific **carbon dioxide** emissions are related to the feedstock selected and furnace fuel gas composition. The use of hydrogen-containing residue gas as fuel can reduce the CO₂ emission from the cracking furnace. However, the benefit of extracting hydrogen from the residue gas for use in other applications needs to be taken into account.

The BAT for gas-fired cracking furnaces and steam superheaters is:

- modern firebox design with extensive energy recovery facilities giving a thermal efficiency of 92 - 95 %
- use of sulphur-free methane or methane/hydrogen mixture as fuel, with combustion control to maintain excess oxygen level of 1 – 3 %
- the minimisation of NO_x emissions by the use of preventative techniques such as LNB or ULNB, possibly in combination with end-of-pipe SCR.

BAT associated levels for gas-fired furnaces are given in Table 7.19:

Pollutant	Emission Level (mg/Nm ³)	Control Techniques
Sulphur dioxide	Not relevant	Fuel contains little or no sulphur
Dust	Not relevant	Clean fuel
NO _x (as NO ₂)	75 - 100 60 - 80	Ultra Low NO _x Burners SCR
CO	20	Advanced combustion control
CO ₂	-	Thermally efficient furnace Heat/energy integration
Concentrations as 30 - 60 minute averages at normal temperature and pressure, 3 % oxygen, dry gas		

Table 7.19: BAT-associated levels for gas fired furnaces

7.5.4.2 Decoking drum vent gas

Because furnaces are typically in decoking mode for only 3 % of the time, the use of elaborate de-dusting systems are not appropriate. BAT is to minimise the coke formation through process optimisation and the use of dry cyclones or wet scrubbing systems to abate emissions. Alternatively, the decoking effluent stream may be recycled to the furnace firebox where sufficient residence time permits total combustion of any coke particles. A particulates content of less than 50 mg/Nm³ (as an hourly average) can be achieved.

7.5.4.3 Flaring

Generic BAT for flaring is given in Section 6.4. In lower olefin installations, flaring during start up is to be avoided as much as possible. Some plants are described as having the ability to undertake 'flareless start-ups' but this is not *a priori* regarded as BAT. Best-in-class operating performance of 5 to 15 kg/t ethylene is achievable, with combustion efficiency of 99 % in optimum conditions.

7.5.4.4 Point sources

BAT is the collection of point sources to a suitable purge gas system for recovery into fuel gas or to flare.

BAT for sampling systems is closed loop design.

For atmospheric storage tanks containing toxic compounds (e.g. benzene), BAT is to avoid the possibility of point source emissions through the routing of tank vents to a closed recovery system, within the process, or to a flare system.

7.5.4.5 Sour gas

Acid gases, such as hydrogen sulphide and carbon dioxide, are removed from the cracked gas by reaction with sodium hydroxide (caustic). In some cases amine adsorption/ desorption is used to extract high levels of acid gas initially before final 'polishing' with sodium hydroxide. A sour gas emission may be present if the plant is not able to recover its spent caustic stream or use wet air oxidation techniques to treat this prior to disposal to aqueous effluent.

When the spent caustic is treated by acidification, gaseous hydrogen sulphide is generated, which is either burnt to sulphur dioxide or converted to sulphur in a nearby existing Claus unit.

7.5.4.6 Fugitive emissions

The generic BAT for fugitives, as described in Section 6.3, is applicable to the production of lower olefins. BAT for equipment design on lower olefin installations is governed by the need to meet the fugitive emission standards for critical components such as benzene.

7.5.5 Water emissions

The principal aqueous emissions streams are the process water and spent caustic. The main contaminants include hydrocarbons, dissolved inorganic salts and particulates. BAT for the control of liquid effluents is based on process integrated techniques. Where possible, waste streams are recycled or further processed to maximise recovery and then treated in a central waste water facility.

7.5.5.1 Process water

BAT is to recover the process water downstream of the cracking section and, after suitable treatment and vaporisation, to maximise recycling to the cracking furnaces. Except for the case of some heavy hydrocarbon feedstocks, typically some 90 % of process water may be recycled.

Dilution Steam Generation (DSG) is BAT. This involves washing the condensed process water with a suitable gasoline component, separation via a coalescer or similar device, steam stripping to remove volatile hydrocarbons which are recovered in the process and finally boiling to recycle the water as dilution steam. Approximately 10 % of the water is purged from the system and is directed to final treatment (see 7.5.5.3).

7.5.5.2 Spent caustic

The spent caustic stream contains sodium carbonate, sodium bicarbonate, sodium sulphide and other inorganic salts. Selection of the treatment route is heavily dependent on local conditions and BAT can be:

- recovery for direct sale, or
- treatment in wet air oxidation unit, or
- acidification to allow sulphur recovery (in a Claus unit), or
- acidification prior to incineration, or
- disposal via a sour flare system.

7.5.5.3 Final treatment

BAT for final effluent treatment includes physical separation (e.g. API separator, corrugated plate separator), followed by a polishing treatment (e.g. hydrogen peroxide oxidation or biotreatment). The BAT levels for final water emissions from a central waste water treatment plant are given in Table 7.20.

Pollutant	BAT-associated level ⁽¹⁾ (mg/l) as daily averages
Flowrate	0.3 to 0.5 t/t ethylene ⁽²⁾
pH	7 - 8 pH units
COD	30 - 45 ⁽³⁾ ⁽⁴⁾
TOC	10 - 15 mg/l and 2 - 10 g/t ethylene ⁽⁴⁾
Sulphide ions	0.6
Phosphate	1.5
Nitrogen	25
Phenols	0.15
Benzene	0.05
Total hydrocarbon content	1.5
1. Does not include cooling waters as these are not normally treated. 2. Possibly much larger flows with heavy feedstock. 3. Values assume a COD:TOC ratio of 3:1 4. Values may have been back calculated from the percentage contribution to a central WWTP.	

Table 7.20: BAT-associated levels for effluent from a central waste water treatment plant

7.5.6 By-products and wastes

There are no by-products of the cracking process that require to be disposed of as a continuous waste stream. Significantly more than 50 % of the feedstock is converted to products with higher value. Methane is produced in the process but is used internally as fuel. Pyrolysis oil and gasoline can be marketed as fuels.

BAT for solid wastes includes the following techniques:

- organic wastes that are periodically removed from the plant (e.g. heavy sludges in the bottom of API separators) are incinerated (e.g. by specialist waste disposal contractors)
- spent catalyst is treated (e.g. by the supplier or a reclaimer) to recover precious metals
- coke fines recovered from gas dedusting during decoking are disposed of in an immobilised form (e.g. by incineration, landfill)
- spent adsorbents are disposed of by landfill or incineration.

7.6 Emerging techniques

It is logical to consider possible advances in ethylene production processes in terms of developments based on conventional feedstocks and developments using new feedstocks [EEPC, 2000 #132].

7.6.1 Developments with conventional feedstocks

The recent key innovations that have already occurred in the production of ethylene may give some insight into the possible direction of future developments. A survey of recent trends [Hutcheson, 1995 #61] showed that between the late 1960's and late 1970's the price of oil (and hence feedstock) was the primary economic influence on the ethylene industry. Most process innovation involved changes to plant configuration to improve energy efficiency and flexibility of feedstock choice. This was followed, in the late 1970's to early 1990's, by innovation in micro-electronics that lead to the application of enhanced process control technologies.

Innovation arose not only from producers, but also from contractors and equipment manufacturers.

More recently there has been production over-capacity and hence little demand for new plants. The main growth market for new plants has been in developing economies, particularly around the Pacific Rim, where the demand has been for cheap, well-proven equipment. The innovation emphasis in developed economies has switched to plant de-bottlenecking, operating cost reduction and environmental protection. Some recent advances include:

- use of gas turbines as power sources and using exhaust gases as furnace combustion air
- process optimisation systems (including monitoring and automation)
- systems to prevent emissions to atmosphere from de-coking
- silica and aluminised furnace tubing to reduce coking
- swaged tube designs to reduce the effects of tube fouling
- product recovery systems with higher energy efficiency and capacity
- steam stripping of benzene from waste water
- recycling of caustic stream
- removal of chromate from waste water
- split flow processes to improve the efficiency and capacity of oil separation
- variable speed motors to drive the cracked gas compressor
- modifications to tube geometry within the furnace
- increased furnace efficiency by use of more tubes and improved heat release from burners
- higher furnace operating temperature through improved tube metallurgy and manufacture
- burner enhancements to reduce NO_x, CO and coke emissions
- improved compressor and turbine efficiency.

In the immediate future, it is expected that steam crackers will continue to dominate the production of ethylene and propylene, but major developments are expected as follows [Decroocq, 1997 #125]:

- there will be continued de-bottlenecking of existing units since modern crackers have capacities in the order of 500 kt/yr
- plants will seek to develop feedstock flexibility so that they can take advantage of (cheaper) feeds that they were not necessarily designed for. New feeds may include gas condensates and the less desirable refinery product streams (C₄ and heavier)
- the selectivity to the most useful products will be optimised – notably for propylene which has a more rapidly growing demand than ethylene. This may favour older crackers that are not yet modified to the high severity that is needed to maximise ethylene production.

In the longer term, other processes may challenge the dominance of steam cracking because they produce a more desirable balance of products. A strong competitor may be advanced short contact time fluid catalytic cracking (FCC). Advanced FCC is already a large source of propylene in the USA and Europe and, subject to process advances, might become an important source of ethylene and C₄ and C₅ olefins [Decroocq, 1997 #125]. More olefins can be produced in the C₃-C₄ and C₅ cuts from FCC units by adding small quantities of ZSM5 zeolite to the catalyst [Decroocq, 1997 #125].

BP in Grangemouth has a selective olefins recovery pilot plant to investigate the potential for non-cryogenic fractionation. The operation is based on the selective absorption of olefins into a circulating absorbent (that acts as a ligand). The absorbent is then regenerated by de-sorbing, and recovering, the olefins. The pilot plant can recover small quantities of ethylene but the economic and commercial viability of this technology is still being evaluated.

IFP and Gaz de France have been researching a steam cracking process that operates at very high temperature using ceramic furnaces.

7.6.2 Developments with new feedstocks

Thermal (steam) cracking is very energy consuming and the ‘holy grail’ is a process that enables the catalytic conversion of methane to Lower Olefins (also known as Gas to Olefins – GTO). Norsk-Hydro and UOP have co-patented a process for catalytic conversion but there has been no commercial application.

There is also a methanol to olefins process (MTO) which is under development. Many companies are looking at MTO and GTO but so far there has been no substantial cost or technology breakthrough to differentiate this against the best of the existing steam cracking technologies. When comparing emissions from such a process, the complete chain from gas field to ethylene needs to be considered and compared with the oil field to ethylene route.

A process route is also being developed for the autothermal cracking of gas feeds. In this process the partial oxidation over a catalyst produces heat to sustain the reaction. However, the route produces large quantities of CO, acid gas and organic acids that require separation and treatment, and so the process has no obvious economic or environmental benefit over existing steam cracking technologies.

A process has been developed by Geconcept Technology to combine the cryogenic natural gas liquid plant, the natural gas liquid fractionation plant and the ethylene plant into a single unit [Ameringer, 2000 #117]. By using the gas plant as a methane refrigeration system, it is claimed that the total refrigeration requirement of the ethylene plant is reduced by 60 – 80 %. The process also uses relatively pure methane from the gas plant residue gas to reflux the ethylene plant demethaniser and this reduces the pressure required to compress the cracked gas (from 500 to 250 psig) and reduces by over 50 % the number of pieces of equipment in the demethaniser section. This approach also eliminates interconnecting pipelines between plants, enables the sharing of common offsite equipment and reduces overall manning levels.

8 ILLUSTRATIVE PROCESS: AROMATICS

8.1 General information

The term ‘aromatics’ is used to describe benzene, toluene, mixed xylenes, ortho-xylene, para-xylene, meta-xylene (commonly known as BTX). The BTX aromatics are produced from three main feedstocks: refinery reformates, steam cracker pyrolysis gasoline (pygas) and benzol from coal tar processing. The processes that produce the feedstocks for aromatic plants are not selective and produce a mix of aromatics that have to be separated and purified for the chemical market. However, the aromatics production routes often include some scope for the upgrading of products according to the market need (e.g. benzene and/or xylene from toluene, p-xylene from mixed xylenes). Aromatics production units may be physically located in either refinery or petrochemical complexes as there are close links to both activities.

The BTX produced as a coke oven by-product in steel production has a small production capacity and is covered in the Iron & Steel BREF [EIPPCB, 2000 #102] under ‘Recovery of light oil from coke oven gas’.

8.1.1 Benzene

Benzene (C_6H_6) exists in the benzol produced from coke manufacture (at typically 70 %), in pygas (30 %) and in reformates (8 %). Benzene is recovered from these sources by a variety of processes. In Europe, pygas treatment produces 55 % of benzene, while 20 % comes from reformat and a few percent from coal tar. The balance is obtained through chemical treatment of other aromatics, either by HDA (the hydro-dealkylation of C_7 and C_8 aromatics such as toluene and xylene) or TDP (toluene disproportionation). In the USA, where gas crackers are widely used, pygas (15 %) is the secondary benzene source to reformat (50 %). The balance of US capacity is produced through HDA and TDP [CEFIC, 2000 #77].

Some 50 % of benzene production is used to produce styrene which is then converted into polystyrene, rubbers and alkyl benzene sulphonate (ABS). A further 21 % of benzene production is used to produce cumene (and then phenol and acetone) and 13 % of benzene is used in cyclohexane production (most importantly for adipic acid and Nylon). The fuller importance of benzene is shown in Figure 8.1.

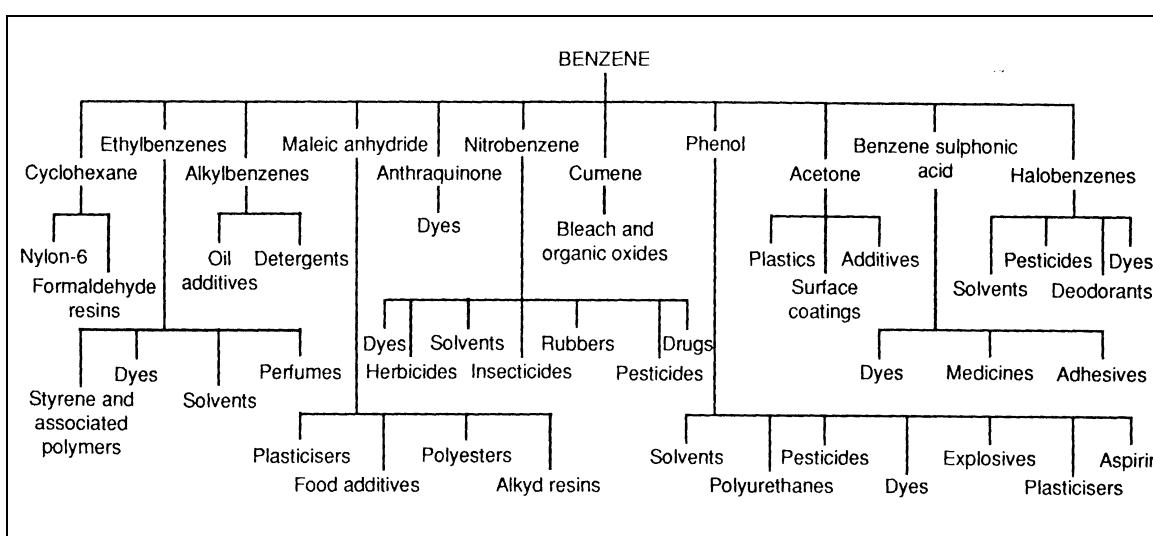

Figure 8.1: Uses of benzene
[EC DGXI, 1993 #8]

8.1.2 Toluene

In Europe, pygas and reformat feedstocks each account for 50 % of toluene (C_7H_8) production, while in the USA reformates predominate (85 %). Over 50 % of toluene production is used for the production of benzene (and xylene) by hydro-dealkylation or disproportionation. A major use of toluene is the production of phenol, a raw material for the production of caprolactam, which is, in turn, a raw material for the production of nylon, synthetic fibres and resins. A further 12 % of toluene production is used to make toluene diisocyanate (TDI) [CEFIC, 2000 #77]. Other uses are shown in Figure 8.2.

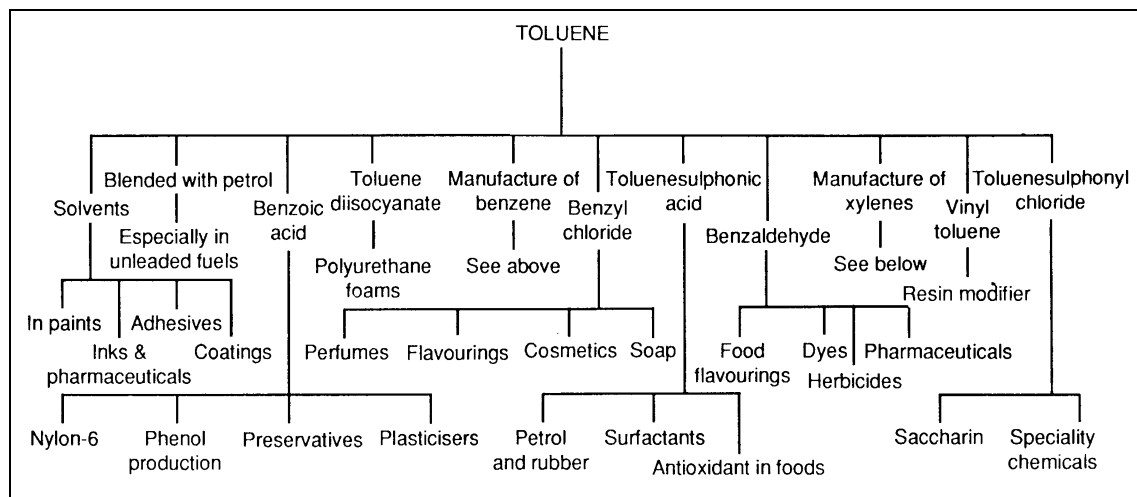

Figure 8.2: Uses of toluene
[EC DGXI, 1993 #8]

8.1.3 Xylenes

In Europe and the USA reformat is the main source (85 – 90 %) of xylenes (C_8H_{10}). Xylenes production normally focuses on para-xylene, but most producers also extract ortho-xylene product. Some producers also extract also meta-xylene. Ethylbenzene can be separated by super-fractionation before o-m-p xylene processing. The uses of xylenes are shown in Figure 8.3. Para-xylene is transformed into polyethylene terephthalate (PET) which is used mainly in the production of plastic bottles. Mixed xylenes are mainly used as solvents whilst ortho-xylene is used for phthalic anhydride.

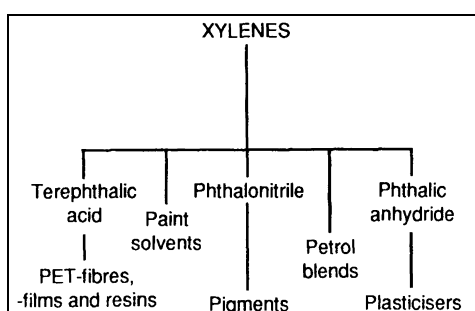

Figure 8.3: Uses of xylenes
[EC DGXI, 1993 #8]

8.1.4 Cyclohexane

Some aromatics plants include a cyclohexane unit and, although not an aromatic substance, it is covered here due to the integrated nature of the cyclohexane process. It is produced from pure benzene.

8.1.5 Production capacity

Aromatics production is distributed across Europe as shown in Table 8.1 and Table 8.2.

Country	Benzene		Toluene		P xylene	
	N° of units	Nameplate capacity (kt/yr)	N° of Units	Nameplate capacity (kt/yr)	N° of units	Nameplate capacity (kt/yr)
Austria	1	30	1	5	-	-
Belgium	3	215	2	75	(Note 1)	(Note 1)
Finland	1	140 ⁽²⁾	-	-	-	-
France	8	1030	3	105	1	130
Germany	16	2220	8	885	4	370
Italy	6	850	4	400	2	300
Netherlands	5	1630	1	250	1	500
Portugal	1	60	1	140	1	125
Spain	3	485	2	320	1	90
UK	9	1450	4	550	1	330
Total	57	8100	28	2760	11	1850

Note 1: One new unit (of 420 kt/yr) will start up in 2000
Note 2: Capacity now 110 kt/yr

Table 8.1: European aromatic production sites [CEFIC, 2000 #77] as amended by TWG comments

Country	Location	Benzene	Toluene	p-xylene
Austria	Schwechat	X	X	
Belgium	Antwerp	X	X	
Finland	Porvoo	X		
France	Berre	X	X	
	Carling	X		
	Dunkerque	X		
	Feyzin	X	X	
	Gonfreville	X	X	X
	Lavera	X		
Germany	Böhlen	X		
	Burghausen	X		
	Gelsenkirchen	X		X
	Godorf	X	X	X
	Heide	X	X	
	Köln-Worringen	X	X	
	Lingen	X		
	Ludwigshafen	X		
	Schwedt	X	X	X
	Wesseling	X	X	X
Italy	Mantova		X	
	Porto Marghera	X	X	
	Porto Torres	X	X	
	Priolo	X	X	X
	Sarroch	X		X
Netherlands	Geleen	X		
	Botlek	X	X	X
	Terneuzen	X		
Portugal	Oporto	X	X	X
Spain	Algeciras	X	X	X
	La Rabida	X		
	Puertollano	X		
UK	Grangemouth	X		
	Middlesborough	X		
	Stanlow	X	X	
	Wilton	X	X	X

Table 8.2: Location of EU aromatics plants [CEFIC, 2000 #77]

8.1.6 Economics

The West European aromatics industry is a large business and in 1998 production amounted to over 10 Mt (with a value of \$2.3 billion).

Production rates. In 1997, the global benzene market was approximately 28 Mtpa with an annual production of 6.5 Mt in Western Europe, 8 Mt in the USA and 4 Mt in Japan. In 1997 the EU annual production rates of other aromatics were: toluene (2.6 Mt), o-xylene (0.7 Mt), p-xylene 1.4 (Mt) and cyclohexane (1.1 Mt). Aromatics are liquid hydrocarbons at ambient temperature and can be readily imported from distant countries. Although there is reduced aromatics production in the Far East, the US Gulf and Arabic Gulf production is accessible to Europe.

Growth. Between 1988 and 1997, European benzene production grew by an average of 1.5 % per year, with a particularly sharp increase during 1993 to 1995. A major factor on Europe's future production of benzene is the EU Auto-Oil Directive. Aromatics are present in gasoline to increase the octane content but, as of 01/01/2000, the Directive has required the benzene concentration to be reduced from <5 % (it was typically <3 % anyway) to <1 %. This will cause EU benzene production to increase (by between 0.5 and 1 Mtpa) and this may affect the supply-demand balance. There is low forecasted growth of the EU benzene production capacity between 1998 - 2003 and it will be mainly driven by the need to recover benzene from upstream feedstocks in response to the Auto-Oil directive. The growth rates of other aromatics are very weak. Only para-xylene has shown significant increased demand and this is due to the growing use of PET (polyethylene terephthalate) for packaging [CEFIC, 2000 #77].

Market prices. The aromatics market is complex as it concerns six main products (benzene, toluene, mixed xylenes, o-xylene, p-xylene, cyclohexane) that are produced from very different processes and feedstocks. The market prices of aromatics products are linked to each other, and also depend on the crude oil cost, the naphtha price and the US\$ exchange rate. Prices also vary with the season since light cracker feedstocks (e.g. LPG) are used more in summer and they produce fewer aromatics than heavier feedstocks. As a consequence, the markets are highly volatile and a small extra supply can produce a considerable price depression (and *vice versa*).

Figure 8.4 and Figure 8.5 show the volatility of European spot prices for benzene and para-xylene, and also their overall trends of reducing price.

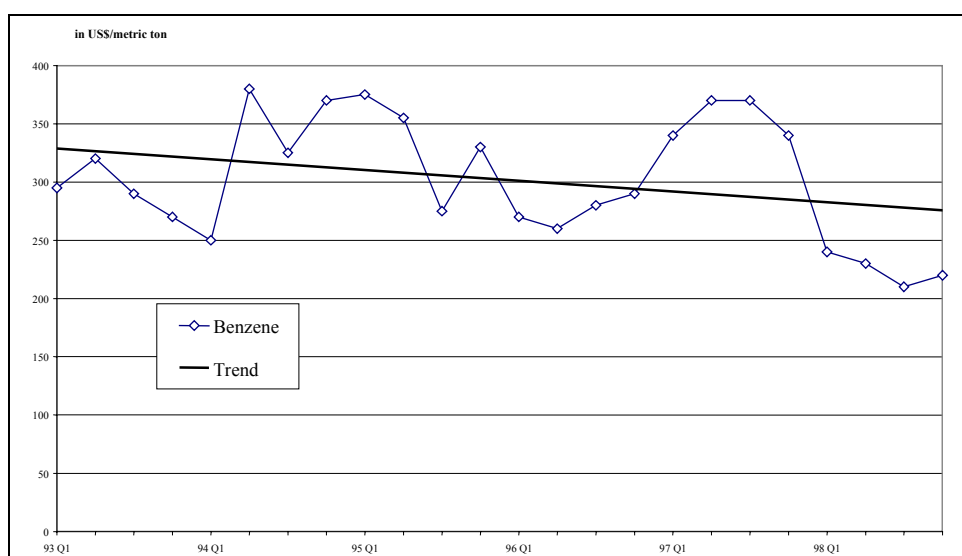

Figure 8.4: Price trend for European spot prices of benzene (1993 - 1998) [CEFIC, 2000 #77]

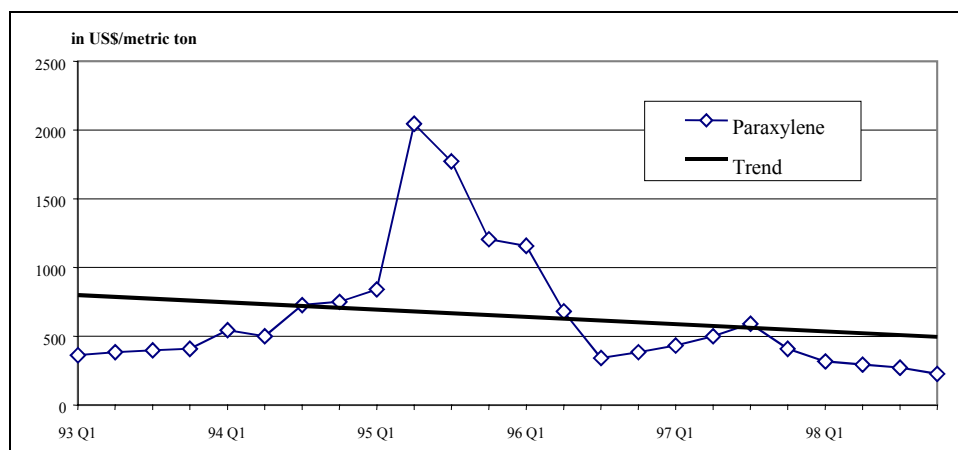

Figure 8.5: Price trend for European spot prices of paraxylene (1993 - 1998)
[CEFIC, 2000 #77]

Other aromatics and feedstocks have had high price volatility over the period 1993 - 99 and Table 8.3 shows how the cost indices have varied relative to the average price for each chemical.

Chemical	Relative maximum price (date)	Relative minimum price (date)
Naphtha	133 (Q3-96)	63 (Q1-99)
Benzene	130 (Q4-94)	72 (Q1-99)
Toluene	131 (Q4-99)	77 (Q1-99)
p-xylene	183 (Q4-95)	58 (Q1-99)
Pygas	127 (Q3-93)	69 (Q1-99)

Table 8.3: Aromatics cost indices 1993 - 99
[CEFIC, 2000 #77]

Profitability. It is difficult to analyse the profitability of BTX production due to the range of different processes and feedstocks, but computer models can be used to quantify theoretical production economics. Chemical Market Associates Inc (CMAI) has two models that cover the profitability of benzene and toluene production from reformat and pygas, and these are used to produce confidential economic surveys for sale to subscribers.

A CEFIC summary [CEFIC, 2000 #77] of CMAI's October 1998 'Petrochemical model' considers a typical unit taking 540 kt/yr of pygas to produce 160 kt/yr of benzene, 80 kt/yr of toluene and 300 kt/yr of raffinate. On the basis of an Investment Cost of 80 M€ and Production Costs of 30 €/t, the operating margin was 2.12 M€/year. Since the margin pays for depreciation, interest on invested capital (12 M€/year on capital of 80 M€) and shareholder dividend, the facility was operating at a loss. Another study by ChemSystems in Q1/Q2 1999 showed that the extraction of benzene from pygas by the leader plant for Extractive Distillation would just cover its Production Costs and plant depreciation (excluding financial costs).

A CEFIC summary [CEFIC, 2000 #77] of a ChemSystems report on the profitability of xylenes production identifies a large spread between the leader and laggard plants in Q2 1997. The leader had a total production cash cost of €210 / tonne p-xylene and the laggard €495 / tonne p-xylene. This compares with a p-xylene market price of €390/tonne.

These economic analyses demonstrate that the markets for aromatics are highly volatile, with a general surplus of production and depressed demand. This makes it difficult to forecast long-term market prices, profitability and investment planning. However, new technologies such as conversion of LPG into aromatics may make new investment a realistic prospect.

8.2 Applied processes and techniques

There are a large variety of plant configurations for the production of aromatics and these range from simple systems for the sole production of benzene, to complicated plants producing the whole range of aromatics. Except in some particular cases, benzene production units also co-produce toluene and xylene (which may be separated for sale as pure products or upgraded to benzene).

The choice of production process is a strategic decision that depends on the feedstock availability and cost, and the demand for aromatic products. The composition of pygas and reformat feedstocks can be influenced to some extent by adjusting the operating conditions and feedstock quality of the steam crackers and reformer, but aromatics always remain secondary products of the processes to produce olefins and gasoline. Pygas and reformat are never supplied as pure cuts but, once aromatics have been extracted, the remainder of the feedstock (i.e. the C₅ cut and C₆-C₈ non-aromatic cut 'Raffinate') can realise value in the car gasoline pool of refineries or can be recycled as feedstock to steam cracking plants.

Such are the variations of feedstock and desired products that each aromatic plant has an almost unique configuration. However, aromatics production from a petrochemical feedstock will utilise some, or all, of a set of closely connected and integrated unit processes that allow the separation of aromatics (from non-aromatics), the isolation of pure products, and the chemical conversion to more beneficial products.

Separation and isolation of aromatics. The isolation of pure benzene from its feedstock is complex as it forms azeotropes with many C₆, C₇ and C₈ alkanes. The azeotropes can be broken using the sophisticated physical separation processes that are shown in Table 8.4. These processes are typically operated at pressures below 10 bar and temperatures below 220 °C, but may necessitate the purification and recycle of an extraction solvent. In practice the most widely applied methods are solvent extraction followed by distillation.

Unit operation	Separation problem	Requirement for basic / economic operation
Azeotropic distillation	BTX separation from pygas	High aromatic content (>90 %)
Extractive distillation	BTX separation from pygas	Medium aromatic content (>65 – 90 %)
Liquid-liquid extraction	BTX separation from reformat gasoline	Lower aromatic content (20 – 65 %)
Crystallisation by freezing	Isolation of p-xylene from m/p mixtures	Distillative pre-separation of o-xylene and ethylbenzene from C ₈ aromatic fractions
Adsorption on solids	Isolation of p-xylene from C ₈ aromatic fractions	Continuous, reversible and selective adsorption
Complex with BF ₃ /HF	Isolation of meta-xylene from xylene mixture	Selective complexation.

Table 8.4: Typical unit operations for aromatic recovery
[Weissermel & Arpe, 1993 #59] [Federchimica, 2000 #122]

Azeotropic distillation is not a widely used unit operation, but it involves the addition of strongly polar auxiliary agents (alcohols, ketones, water) facilitates the removal of alkanes and cycloalkanes. An assumption for the use of azeotropic distillation is that the fractions are narrow cuts, from which the non-aromatics are removed. Acetone is added to recover the benzene fraction, whilst methanol is used in the case of the toluene or xylene fraction. The acetone or methanol is extracted with water, recovered by distillation and recycled to the azeotrope column [Austria UBA, 2000 #129].

Just as in the azeotropic distillation single, narrow-cut fractions are used for **extractive distillation**. The aromatic fraction is fed into the middle of the column, whereas the selective solvent is fed at the top. The non-aromatics leave the column at the top and the solvent with the

aromatics is removed from the lower part. The bottom product, a mixture of the solvent and the pure aromatic, is separated in a distillation column from the solvent. Compared to the azeotropic distillation, where the auxiliary substance acts on the non-aromatic fraction, in extractive distillation the auxiliary agents act on the aromatic fraction and decrease its volatility [Austria UBA, 2000 #129].

Many different solvents and mixtures are used in commercial **liquid-liquid extraction** processes. The numerous modifications of liquid-liquid extraction are all characterised by counter-current operations. Normally an extraction column is used, where the mixture to be separated is fed in the middle of the column and the solvent is fed at the top of the column. The non-aromatics leave the column at the top, whereas the aromatics with the solvent are removed from the bottom. To improve the separation, part of the purified aromatics fraction is recirculated to the bottom of the extractor to force the non-aromatics completely from the extract. In a further step the extract has to be separated in the aromatics and the solvent. Two different possibilities are available for this separation: direct distillation (often with a steam strip) or the re-extraction of the aromatics from the selective solvent with a light hydrocarbon such as pentane (the aromatics are freed from the solvent by a simple distillation and this method saves the expensive extractant and is energetically favourable). The major difference between liquid-liquid extraction and extractive distillation is that in liquid-liquid extraction the extracting solvent must be polar so that at all stages a readily separable two liquid phase system is retained [Austria UBA, 2000 #129].

The liquid-liquid and the extractive distillation process use selective solvents, which solve the aromatics fraction better than the non-aromatics fraction. Increasing polarity of the solvent increases its selectivity, but decreases its capacity. Solvent residuals in the raffinate (non-aromatics fraction) have to be separated and recycled. The separation of the C₈ fraction (mainly consisting of o-, m-, p-xylene and ethylbenzene) is very difficult and may use techniques such as crystallisation or adsorption on solids.

Crystallisation can only be used when o-xylene and ethylbenzene have been separated from the mixture since they can form eutectic systems with p-xylene. In the first step the high-boiling o-xylene is removed in a distillation column from the ethylbenzene/m-xylene/p-xylene mixture. In the further step ethylbenzene is separated by distillation. An intermediate fraction of m-xylene/p-xylene with a ratio of 2 : 1 remains. This fraction must be carefully dried to remove the water. For this Al₂O₃ or SiO₂ are used and the water content of the mixture is approximately 100 ppm after the drying. This water free mixture is then cooled to temperatures between -20 and -75 °C and the p-xylene deposits on the cold walls. Then p-xylene is scraped from the cold walls by scrape chillers and removed as a crystal sludge. The crystal sludge is separated in a crystal cake and a filtrate by using filters or centrifuges. After the first stage of this process the crystal cake contains about 70 % of p-xylene. p-xylene of 99.5 % purity can be obtained by using a series of melting and crystallisation processes [Austria UBA, 2000 #129].

The separation of p-xylene can be also achieved by **adsorption on solids** that have a surface and the pore structure with an adsorption specificity for p-xylene. Two different processes have commercial application. In the Aromax process, p-xylene is selectively adsorbed on modified zeolites (molecular sieves) from the liquid phase at 200 °C and 15 bar. The Parex process uses porous solid adsorbents at 120 to 175 °C in the liquid phase and the desorption is performed by washing with toluene or p-diethylbenzene [Austria UBA, 2000 #129].

Chemical conversion. The initial product streams can be converted into more beneficial products by using such techniques as:

- toluene to benzene by hydrodealkylation (THD or HDA)
- toluene to benzene and xylene by toluene disproportionation (TDP)
- xylene and/or m-xylene to p-xylene by isomerisation.

These processes are operated at pressures below 30 bar and temperatures below 400 °C although THD temperatures can be as high as 750 °C, and pressures up to 60 bar.

Most of the aromatic processes are built and designed by technology providers which are typically internationally based and have been developed using the current best available techniques. The process designs do not normally incorporate venting to atmosphere. Another important aspect of most of these processes is that they are typically designed and integrated with adjacent operating units and processes. In the chemical plants or refinery complexes, integration allows for common use of utilities, by-product handling and common facilities such as flare systems and waste water treatment.

Many different configurations and integration with adjacent facilities are possible. In order to simplify this situation, CEFIC have proposed that there are three typical aromatic plant configurations [CEFIC, 2000 #113]:

Plant configuration	Basic unit operations
A. Integrated olefins complex and BT (Benzene/Toluene) or BTX (BT & Xylenes)	Dienes hydrogenation, distillation, extraction or extractive distillation for benzene recovery, hydrodealkylation plant
B. Integrated refinery complex and BT (Benzene/Toluene) or BTX (BT & Xylenes)	Distillation, extraction for benzene recovery, clay treating, p-xylene recovery, toluene or xylene isomerisation
C. Polyester complex based on PX (p-xylene)	Feed washing, distillation, p-xylene recovery (adsorption or crystallisation), xylene isomerisation.

As an indication of the complexity of aromatics processes, there are in excess of 70 process licences and over 20 licensors, each with different feedstocks and process characteristics to suit local conditions [CEFIC, 2000 #78]. A summary of typical processes for the production of aromatics is given in Table 8.5.

Process	Aim of process	Process conditions				Other characteristics
		Pressure (bar)	Temp (°C)	Catalyst (or solvent*)	Reaction component	
1. Refining processes:						
Hydrogenation of pygas	Hydrogenation of diolefins and desulphurisation	40 – 60	200 – 250	Co, Mo, Ni, Pd	H ₂	Two-stage process
Benzole pressure refining	Hydrogenation of coke oven benzole	20 – 50	350	Co, Mo	H ₂	Reduction of sulphur to below 0.5 ppm; removal of unsaturated hydrocarbons, which hamper the production of benzene by distillation
Cyclar (UOP)	Aromatics from LPG's	2 - 10	475 - 650	Zeolite		Upgrades well-head gases to aromatics
2. Dealkylation processes:						
Houdry Litol	Production of benzene from toluene	50	600	Co, Mo	H ₂	Hydrogenation of unsaturated compounds; hydro-cracking of non-aromatic; desulphurisation, dealkylation & dehydrogenation of naphthenes lead to higher benzene yields
Houdry, dealkylation (HDA)		45	max. 750	-	H ₂	Benzene yield up to 99 %
THDA (UOP)	Benzene from toluene by thermal route	30 - 100	550 - 800	none		Lower conversion than catalytic route
3. Isomerisation processes:						
Octafining	Increasing the proportion of p-xylene	10 - 30	425 – 480	Pt/Zeolite	H ₂	Comparable with Isomar (UOP), Isoforming (Exxon) and Isarom (IFP) processes
MAHI (Mobil)	p-xylene from mixed xylenes	Vapour phase		ZSM-5 catalyst		
4. Transalkylation:						
Arco	Production of benzene and C ₈ aromatics from toluene	2	480 – 520	Al ₂ O ₃ /SiO ₂	--	Fluidised-bed process in the gas phase
Tatoray		10 - 50	350 – 530	Zeolite	H ₂	Adiabatic process
Mobil LTD		46	260 - 315	Zeolite	--	Service life of catalyst around 1.5 years
5. Extraction processes:						
Udex process	Extraction of aromatics	5 - 8	130 – 150	Diethylene glycol*		Ratio of solvent : crude aromatic = 6 - 8 : 1
Sulfolane process		2	100	Sulfolane*		Ratio of solvent : crude aromatic = 3 - 6 : 1
Arosolvan process		1	20 - 40	N-methyl-pyrrolidone*		Ratio of solvent : crude aromatic = 4 - 5 : 1
IFP process		1	20 - 30	Dimethyl-sulfoxide*		Ratio of solvent : crude aromatic = 3 - 5 : 1
Morphylex process		1	180-200	N-formyl-morpholine*		Ratio of solvent : crude aromatic = 5 - 6 : 1
Carom (UOP)		1	120	Tetraethylene glycol ('Carom concentrate')		Ratio of solvent : crude aromatic = 3 : 1
Glitsch GT-BTX	Bx/toluene from cat reformer feedstock	1	120	Dimethylsulphoxide solvent		Ratio of solvent : crude aromatic = 2.5 : 1
6. Extractive distillation:						
Distapex process	Production of aromatics	1	≤ 170	N-methyl-pyrrolidone*		Ratio of solvent : crude aromatic = 2.5 - 4 : 1
Morphylane process		2	180 - 200	N-formyl-morpholine*		Ratio of solvent : crude aromatic = 3 : 1
7. Crystallisation processes:						
Amoco process	Production of p-xylene	Atmos.	-55 to -65	--	--	Two-stage melt crystallisation
8. Adsorption:						
Parex(UOP)	p-xylene from mixed xylenes	Liquid phase	120 - 175	Molecular sieves in 'moving bed'		97 % p-x recovery

Table 8.5: Summary of typical processes for the production of aromatics
Based on [Stadelhofer, #115]

As it is difficult to give definitive process descriptions the following sections give generic descriptions of processes based on pygas and reformat feeds.

8.2.1 Benzene from pygas

An excellent source of BTX-aromatics is the pyrolysis gasoline (pygas) that is produced, in addition to ethylene, by the high-temperature, short-residence time cracking of paraffin gases, naphthas, gas oils or other hydrocarbons. According to the cracking severity, the pygas contains typically 20 – 40 % benzene, 16 – 20 % toluene, 10 – 13 % higher aromatics (e.g. ethyl benzene, styrene, xylenes), with a balance of non-aromatic hydrocarbons (mainly olefins and di-olefins) [CEFIC, 2000 #78].

A generic production process is shown in Figure 8.6. The first step of the process (Platfining) typically consists of ‘feedstock preparation’ in a two-stage hydrogenation unit to remove the unsaturated molecules (olefins and di-olefins) and compounds containing sulphur, nitrogen and oxygen. The first stage uses moderate temperature to selectively treat the di-olefins and is followed by a distillation step to remove the lights and heavies. The second, higher temperature, hydrogenation stage (typically 300 °C) simultaneously de-sulphurises the feedstock and hydrogenates the mono-olefins. The resulting product, after lights and heavies removal, contains typically 40 % benzene and 20 % toluene.

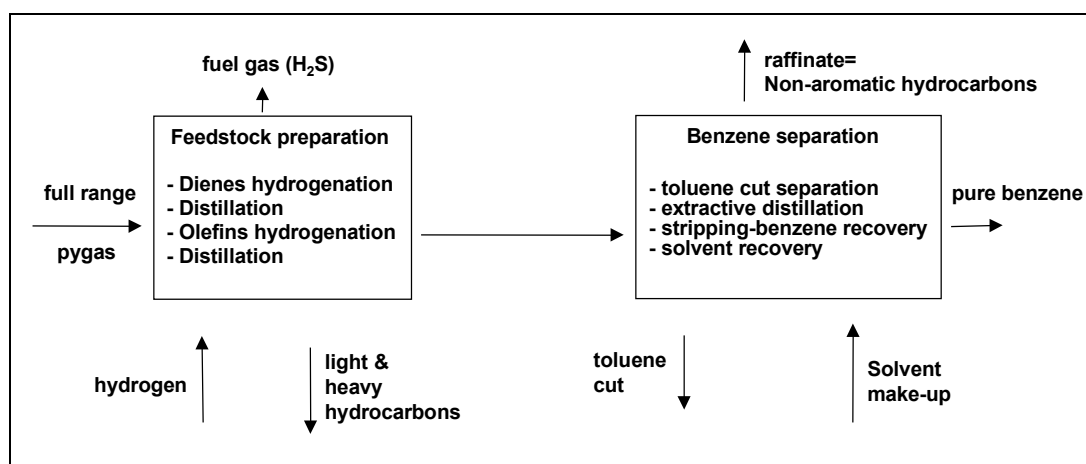

Figure 8.6: Benzene production from pygas using extractive distillation [CEFIC, 2000 #78]

The second step (‘Benzene separation’) isolates the single aromatic components. The toluene cut is first freed from the feedstock. The non-aromatics and benzene are then separated by extractive distillation or by liquid-liquid extraction. The solvents are highly polar substances that demonstrate a high affinity to benzene. The choice of solvent is the key cost factor since better solvents are needed in lower quantities, use less energy, and require smaller equipment. Commonly used solvents are given in Table 8.5.

8.2.2 Benzene and toluene from reformat or pygas

The pygas process (above) can also be used to produce pure benzene and toluene from pygas or from the reformat BT (benzene / toluene) cut of a refinery Platformer. The process can be applied, provided that:

- a narrow benzene and toluene cut is distilled at the feedstock preparation step
- the cut is directly treated by liquid-liquid extraction or extractive distillation, where benzene and toluene are simultaneously extracted by the solvent
- pure benzene and toluene are distilled from the product recovered from the top of the solvent stripper.

8.2.3 Benzene and para-xylene from reformate

Reformate is produced in refineries by the hydrotreatment of naphtha (to remove sulphur and nitrogen) followed by catalytic reforming (to optimise aromatics generation) and so this process is covered in the Refineries BREF. As shown in Figure 8.7, the resulting reformate is separated by distillation into three aromatic cuts (C_7 , C_8 and $C_{9/10}$) for use as feedstocks inside the aromatics plant.

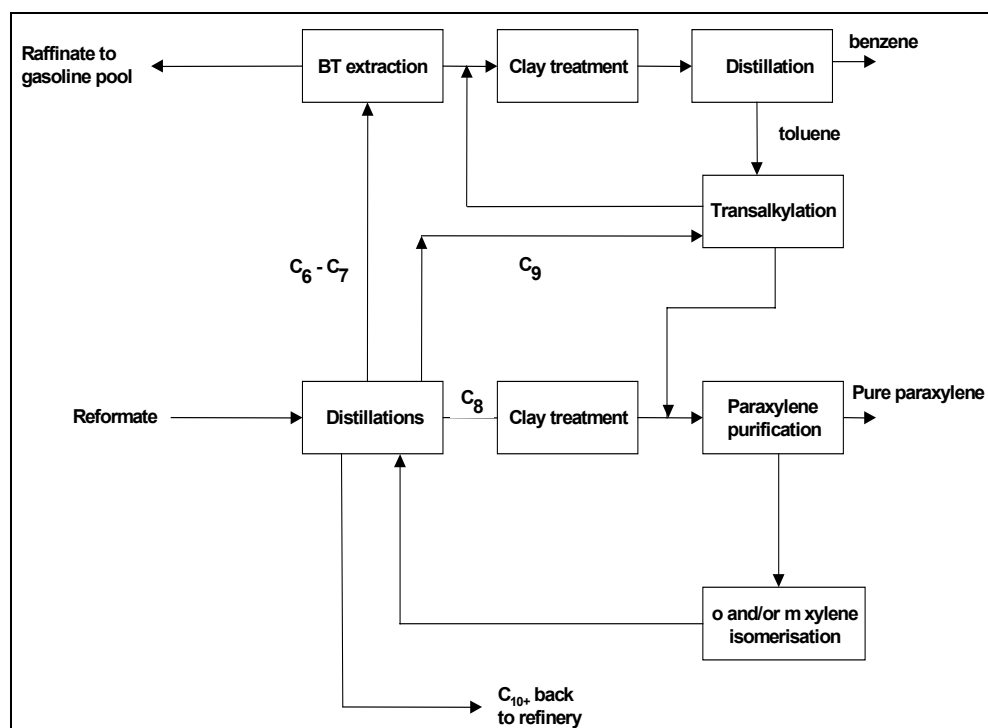

Figure 8.7: Production of benzene and para-xylene from reformate
[CEFIC, 2000 #78]

The C_6 - C_7 cut is treated by liquid-liquid extraction or extractive distillation to produce pure benzene and toluene cuts. The remaining non-aromatics (raffinate) are recycled to the refinery or to a steam cracking plant.

The C_8 cut is used as the source of para-xylene. The xylene isomers have similar boiling points (138 - 144 °C) and so it is not possible to separate para-xylene by distillation. Separation is therefore effected by adsorption (often in a continuous circulating bed) or crystallisation (taking advantage of the different melting points of para-xylene and the other xylene isomers). Once depleted of para-xylene, the mixed isomer stream may undergo isomerisation to convert the ortho and meta isomers into additional para-xylene.

The C_9 / C_{10} cut is mixed with the toluene cut and undergoes a transalkylation to yield mixed xylenes (for recycle to the para-xylene separation step) and benzene (for purification in the distillation unit).

This standard process configuration can be modified to meet particular market needs, for example:

- toluene (and the depleted xylenes cut) can undergo hydro-dealkylation to generate additional benzene (by subsequent distillation)
- toluene may undergo disproportionation to produce more valuable benzene and xylenes
- pure o-xylene may be distilled and sold as marketable product
- the xylenes cut can be sold or shipped as feedstock for o-m-p xylene production plants
- pure m-xylene may be extracted and sold as a marketable product.

8.2.4 Cyclohexane

The boiling points of benzene, cyclohexane and their azeotrope are similar, so it is not possible to effect separation by distillation. Hence, in the hydrogenation of benzene to cyclohexane it is necessary to avoid a mixed product stream by reacting all of the benzene. The hydrogenation is carried out initially in a liquid phase (in the presence of a solid or dissolved nickel catalyst) and then gas phase catalytic hydrogenation to convert the remaining benzene. The pure cyclohexane is obtained after degassing the dissolved gases through a light stripping operation.

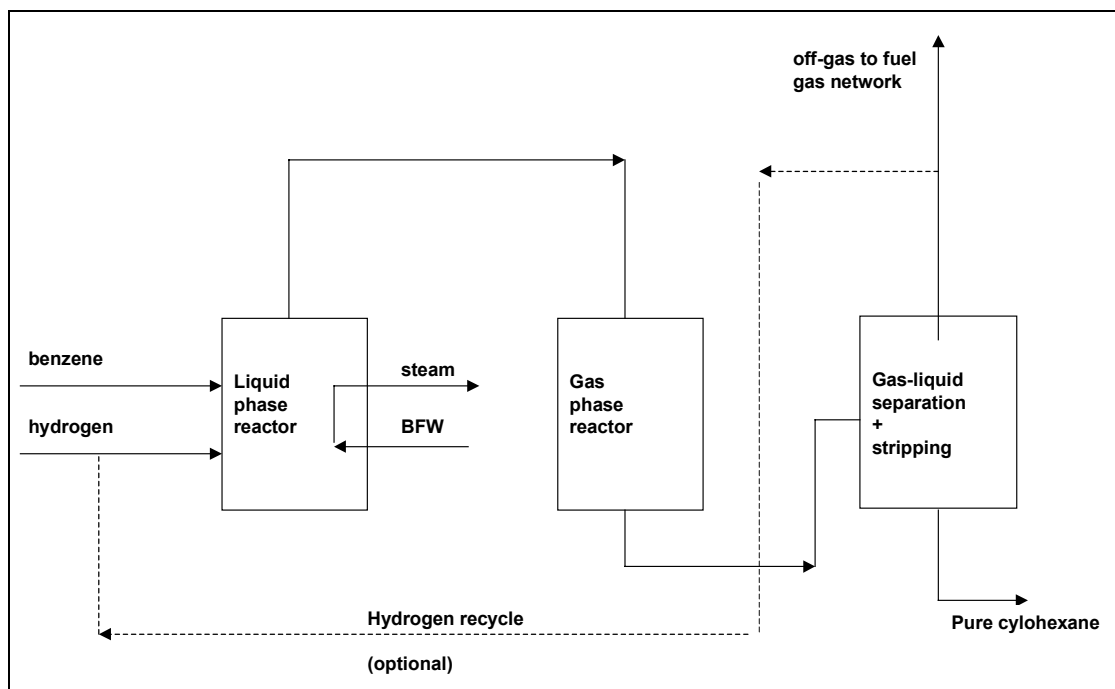

Figure 8.8: Cyclohexane production
[CEFIC, 2000 #78]

8.2.5 Auxiliary chemicals

A number of auxiliary chemicals are used in the processes described above.

- hydrogen to prepare the feedstocks (olefins and di-olefins conversion), to convert higher aromatics into benzene by HDA, and to convert benzene into cyclohexane
- hydrogenation catalyst (for liquid or gas phase reactions)
- other catalysts (for disproportionation, isomerisation)
- adsorbents (for xylene separation)
- clay (for olefins removal)
- solvents (for benzene extraction and para-xylene extraction)
- fuel gas (consumed and produced)
- nitrogen (for inerting, blanketing)
- process water (to improve the benzene extraction solvent performances)
- steam (flare, ejectors)
- process chemicals (e.g. inhibitors, stabilisers).

8.2.6 Integrated environment protection units

An aromatics plant is generally installed either inside a refinery, or a petrochemical complex, and it takes advantage of the environmental infrastructure, and particularly [CEFIC, 2000 #78]:

- the re-use of the depleted cuts (once the desirable substances have been extracted) as components of car gasoline or as feedstocks for steam cracking plants
- the re-use, in a complete fuel gas network, of the lightest products, such as the hydrogenation reaction vents. A Dutch plant has used a Linhoff exercise (pinch technology) to exploit all possibilities for optimised heat exchange and heat recovery [InfoMil, 2000 #83]
- the utilities generation
- the H₂S removal from off-gas
- the energy saving management techniques
- the flare network
- the central waste water treatment plant
- the bulk storage of aromatics in either [EC DGXI, 1990 #16]:
 - double seal floating roof tanks, or in fixed roof tanks incorporating an internal floating roof with high integrity seals
 - fixed roof tanks which, for a given product or intermediate, have interconnected vapour spaces and vapour recovery or absorption at a single vent
- the loading or discharging of aromatics (or aromatics-rich streams) from road tankers, rail tankers, ships and barges use closed vent systems (which include the vehicle itself). The vapours are connected to either a vapour recovery unit, burner or flare system. Where feasible, road and rail tankers are bottom-loaded [EC DGXI, 1990 #16].

8.3 Consumption and emission levels

Emissions from aromatics plants are to a large extent due to the use of utilities (e.g. heat, power, steam, cooling water) needed by the aromatics separation processes. A relatively minor component of the emissions are related to the core process but there may be arisings due to the elimination of certain impurities, inherent waste streams generated during processing and emissions from equipment. Some chemical reactions take place at high pressures and temperatures, but these are inherent to the processes. There are no particular process parameters that lead to a higher than normal emission patterns.

8.3.1 Factors influencing consumption and emissions

Demand for aromatic products varies regionally and the resulting differences in process configuration make it difficult to describe the consumption and emission levels from aromatics plants. A comparison between production units can only be made if the factors in plant performance are understood and taken into account. The local factors include the definition of the emission basis, the measurement technique, plant location and unit capacity / age (all previously explained in Section 4.4).

Two significant factors for aromatics plants are the definition of plant boundaries and the degree of integration with upstream and downstream processes. Plants are usually described in terms of equipment and process units inside battery limits (ISBL) and outside battery limits (OSBL). But aromatics plants are complicated because they involve several different processing steps (each with their own boundaries) that may be located in different parts of a chemical or refinery complex.

Systems such as waste water treatment and flares are typically optimised over a complete chemical complex. Integration with other process units may allow the waste streams to be recovered more efficiently or utilised by other processes within the chemical or refinery complex in the most profitable manner. Vent streams, sometimes containing large concentrations of hydrogen or other valuable components, are typically recovered and re-used within the adjacent refinery or chemical plant.

Emission levels are generally reported 'per tonne of BTX' but this can be a simplistic basis as the different process configurations use different feedstocks (with different starting contents of aromatics) and have widely different process complexity. Account is to be taken of the mass of other product streams that are produced within the plant (e.g. paraxylene and mixed xylenes).

8.3.2 Energy and raw material consumption

As with emissions, the complexity and different products produced in an aromatics complex will affect the energy consumption. In addition to the local factors described earlier, the energy consumption will depend on the aromatics content of the feedstock, the extent of heat integration and the technology. The aromatics production processes can be exothermic, in the case of hydrotreating, or energy intensive, in the case of distillation processing steps. There are many opportunities in a typical plant configuration to optimise heat recovery and usage. These opportunities are typically exploited in the early design stage of new plants or are implemented as small projects within operating plants. The economics of implementing such optimisation projects can depend highly on the plant location, age of the unit, extent of integration with other processes and plant size.

Table 8.6 gives consumption and production data ranges for the three generic process configurations.

	Process configuration		
	Benzene from pygas ⁽¹⁾	Benzene from HDA of TX cuts ⁽²⁾	Reformat plant ⁽³⁾
1. Consumption (per tonne of feedstock)			
Fuel gas	3 ⁽⁴⁾ - 35 kg	Net production 8.0 GJ ⁽⁵⁾	3 - 10 kg
Steam (t)	0.5 - 1	<0.1	0.5 - 1.5
Electricity (MWh)	<0.07	<0.07	<0.07
2. Production (tonnes of product per tonne of feedstock)			
Benzene	0.2 - 0.35	0.83	0.12 - 0.24 ⁽⁶⁾
Toluene	-	-	0 - 0.30 ⁽⁷⁾
Paraxylene	-	-	0.23 - 0.48
Orthoxylene	-	-	0 - 0.25 ⁽⁸⁾
1. Based on a reference unit with fractionation, hydrogenation and extraction steps (liquid-liquid extraction or extractive distillation) but excluding the treatment of the TX and heavier cuts (C ₇ + cut). 2. Based on a reference unit with the hydrodealkylation of TX cuts, the further removal of light and heavy products and the pure benzene recovery. 3. Based on a reference plant fed by aromatic-rich cut reformat and producing pure benzene, pure toluene (or toluene disproportionation), pure p-xylene, and pure o-xylene (or o-xylene isomerisation) but excludes naphtha platforming. 4. May be zero as some units have no heating furnaces. 5. Although the process consumes 2.0 GJ of fuel gas per tonne of feedstock it also produces 10.0 GJ/t of feedstock giving a fuel gas excess (net) of 8.0 GJ/t feedstock. 6. Larger outputs possible using extensive toluene hydrodealkylation instead of toluene disproportionation or toluene transalkylation. 7. The maximum does not correspond to a usual configuration of aromatics plants. Usually, all or part of the toluene is upgraded into mixed xylenes and/or benzene. 8. The configuration 'maximise orthoxylene/minimise paraxylene' is unlikely as the paraxylene market need is much larger than the orthoxylene need.			

Table 8.6: Typical consumption and production performances from aromatics processes [CEFIC, 2000 #113]

8.3.3 Air emissions

Table 8.7 shows the possible air emissions from aromatics plants.

Source	Substance				
	NO _x	SO ₂	CO / CO ₂	VOC	Particulates
Gas-fired heaters	X	X	X	X	
Point sources	X	X	X	X	X
Maintenance activities				X	
Non-channelled emission				X	
Regeneration furnaces	X	X	X	X	

Table 8.7: Emission sources and substances from various aromatics plants
[CEFIC, 2000 #113]

Hydrogenation reactions: The continuous vents from hydrogenations (pygas hydro-stabilisation, cyclohexane reaction) may contain hydrogen sulphide (from the feedstock de-sulphurisation), methane and hydrogen. The off-gas is normally discharged to a fuel gas network to recover calorific value. When necessary, for example under emergency conditions, the off-gas may be flared giving emissions of CO, NO_x, VOC and particulates, depending on the gas composition, as well as the flare type, size and load.

Dealkylation reactions. The dealkylation off-gases can be separated in a hydrogen purification unit to produce hydrogen (for recycle) and methane (for use as a fuel gas) [EC DGXI, 1993 #8].

Combustion emissions: The heating furnaces will give rise to the following combustion gases:

- *Sulphur dioxide.* The fuel gas contains sulphur compounds that are converted into sulphur dioxide by fuel firing.
- *Nitrogen oxides.* All combustion processes cause nitrogen oxides, especially the gas motors in the hydrogen compression unit.
- *Flare stack releases.* These emissions result from combustion processes under less control than furnaces. Incomplete combustion in flares may result in higher emissions of hydrocarbons and soot.

Combustion emissions are quantified in Table 8.8 for three typical process configurations.

	Process configuration		
	Benzene from pygas ⁽¹⁾	Benzene from HDA of TX cuts ⁽²⁾	Reformate plant ⁽³⁾
NO _x	0 ⁽⁴⁾ - 0.056	<0.1	<0.06 - 0.123
SO ₂	0 ⁽⁴⁾ - 0.5	usually negligible	0.146
Particulates	0.0025		0.008

1. Based on a reference unit with fractionation, hydrogenation and extraction steps (liquid-liquid extraction or extractive distillation) but excluding the treatment of the TX and heavier cuts (C₇ + cut).
2. Based on a reference unit with the hydrodealkylation of TX cuts, the further removal of light and heavy products and the pure benzene recovery.
3. Based on a reference plant fed by aromatic-rich cut reformat and producing pure benzene, pure toluene (or toluene disproportionation), pure p-xylene, and pure o-xylene (or o-xylene isomerisation) but excludes naphtha platforming.
4. May be zero as some units have no heating furnaces.

Table 8.8: Combustion emissions to air from aromatics processes (in kg/t feedstock)
[CEFIC, 2000 #113] [Federchimica, 2000 #122]

Volatile Organic Compounds (VOCs): There are not usually continuous VOC emission sources on aromatics plants, although some plants may use vacuum systems that have a continuous air emission. Most VOC emissions are normally from fugitives (e.g. valve, flange

and pump seal leaks) and from non-routine operations (maintenance, inspection). However, due to lower operating temperatures and pressures, the fugitive emissions from some aromatics processes are considerably less than in other LVOC processes where higher temperatures and pressures are employed. The quantification of fugitives is dependent on the calculation method, but CEFIC experts consider that a release of 50 t/year of hydrocarbons (including benzene) is a plausible order of magnitude for non-routine emissions from a typical aromatics installation [CEFIC, 2000 #113]. VOCs may arise from small leaks in the cooling unit as ethylene, propylene and/or propane can be used as coolant fluids in the p-xylene crystallisation unit.

VOCs may also arise from storage tank breathing losses and displacement of tanks for raw materials, intermediate products and final products. The VOCs may be aromatics (benzene, toluene), saturated aliphatics (C₁–C₄) or other aliphatics (C₂–C₁₀) [EIPPCB, 2000 #102].

Table 8.9 gives performance data for two plants in the Netherlands.

Plant	Emission source	Emission type	Pollutant	Emission factor (kg/tonne of BTX product)
Dutch Process A (BTX from aromatic mixture)	Flare release/ flue gases/ gas motors	Point	SO ₂	0.53
			NO _x	0.86 ⁽¹⁾
	Tanks	Point	VOC	0.05 ⁽²⁾
	Various	Fugitive	VOC	0.15 ⁽³⁾
Methane			0.09	
Dutch Process B (benzene from pygas)	Desulphurising	Point source	SO ₂	0
	Furnaces	Combustion	NO _x	0.013
			CO	0
			VOC	0.0008
	Process	Point source	VOC	0
		Fugitive	Benzene	0.010
			Toluene	0.004
			Pentanes	0.004
			VOC saturated C ₁ –C ₄	0.0005
			VOC aliphatic C ₂ –C ₁₀	0.0018
Total Aromatics			0.017	
Total VOC	0.030			
1. Circa 90 % of NO _x is from gas motors and another (undefined) part from the flare. Neither of these sources are included in the CEFIC data and this may explain any differences. 2. Composition is 6 % benzene, 40 % toluene. 3. Composition is 10 % benzene, 7 % toluene				

Table 8.9: Emissions to air
[InfoMil, 2000 #83]

8.3.4 Water emissions

Water may be used in the process to recover small amounts of solvent remaining in the raffinate streams, and stripping steam is used in stripping columns to separate heavy aromatics from the solvent. Process water within aromatics plants is generally operated in closed-loops. Water input, as either steam or water, is sometimes required to account for losses to raffinate and product streams.

In aromatics processes there is generally little or no continuous waste water stream, but the exact quantity depends on the plant configuration. The main waste water source is process water recovered from condensates of the steam jet vacuum pumps and overhead accumulators of certain distillation towers (due to the water content of the feedstock or water added to improve extraction efficiency). These streams contain small quantities of dissolved hydrocarbons and are generally drained to a central treatment facility. Waste water containing sulphide and COD may also arise from any caustic scrubbers. The only other arisings are

unintentional spillages, purge of cooling water, rainwater, equipment wash-water, which may contain extraction solvents and aromatics. Water generated by tank drainage and process upsets may contain aromatics. Waste water containing hydrocarbons may be collected separately, settled and steam stripped prior to biological treatment. CEFIC report that effluents typically contain 1 ppm benzene after treatment by such methods [CEFIC, 2000 #113].

Table 8.10 gives actual performance data for two processes in The Netherlands. In the case of Process A, a central WWTP reduces the benzene level by an estimated 99.8 %. In Process B, the central WWTP reduces aromatics by >99 % (to 0.2 µg/l) and COD by 60 % (to 20 mg/l).

Process A: BTX from aromatic mixture				
Source	Destination	Pollutant	Emission factor (kg/tonne of product)	Waste water flow (m ³ /t of product)
Waste water from process drains/polluted and non polluted areas	Central WWTP (externally)	Benzene	0.003	0.5
		Toluene	0.001	
		COD	0.087	
		N-Kjeldahl	0.0009	
Process B: Benzene from pygas				
Source	Destination	Pollutant	Emission factor (kg/tonne of product)	Concentration (kg/m ³)
Caustic scrubber	Spent caustic oxidiser then to WWTP	Sulphide COD	0.075 not known.	0.8

Table 8.10: Emissions to water from two Dutch aromatics processes
[InfoMil, 2000 #83]

8.3.5 Wastes

The different types of solid wastes are usually treated and disposed of by third parties away from the aromatics complex. There is no production of hazardous waste during normal operation and virtually all the feedstock is recovered into valuable products, or as fuel gas. The major solid waste categories are:

- **Catalysts** - from the liquid or gas phase hydrogenation of olefins/diolefins and sulphur. Typical lifetime of 2 to 5 years. Spent catalysts are typically processed by a reclaimer, often the catalyst supplier himself, to separate the valuable metal for re-use from an inert support usually disposed of via landfill. Catalysts used in Toluene Disproportionation or Xylene isomerisation can have lifetimes up to 10 years.
- **Clay** - from olefins removal and typically having a lifetime of 6 months to 2 years. Clay is typically processed via landfill or incineration for disposal.
- **Adsorbents** - from xylenes separations and typically consisting of alumina or molecular sieves which can have a lifetime as low as 3 to 4 years, but typically more like 10 years. Adsorbents are typically disposed of via landfill.
- **Sludge / solid polymerisation material** - recovered from process equipment during maintenance activities. It is typically incinerated offsite but can be used on-site as a fuel source. Solvent regeneration is typically used in many aromatics complexes to remove a more concentrated stream of sludge from the process. This reduces solvent losses to the environment.
- **Oil contaminated materials and oily sludges** (from solvents, bio-treatment and water filtration) are incinerated under carefully controlled conditions, with associated heat recovery.

Table 8.11 gives actual data on waste arisings from two processes in The Netherlands.

	Source	Destination	Emission factor (kg/tonne of product)
Process A (BTX from aromatic mixture)	Catalysts	Recycled via supplier	0.05
	Clay from clay treaters:	Re-use after regeneration	0.03
	Desiccant material	Re-use after regeneration	0.01
	Inert balls	Re-use after regeneration	0.02
	Activated carbon	Incineration	0.01
	Filter cloth, etc.	Incineration	0.01
			Total 0.14
Process B: (benzene from pygas)	Reactor catalyst	Supplier	0.037

Table 8.11: Waste arisings from two Dutch aromatics processes
[InfoMil, 2000 #83]

Solid waste arisings from the production of benzene via crude oil are reported to be 15.6 kg/t of benzene product [Austria UBA, 2000 #129].

8.4 Techniques to consider in the determination of BAT

8.4.1 Air emissions

8.4.1.1 Combustion emissions

All aromatic recovery or production facilities use energy to separate or transform feedstocks into the desired products. The required energy is typically achieved by combustion of gas (natural gas or fuel gas) or fuel oil originating from the refinery or petrochemical complex and this produces emissions of mainly CO₂, SO₂, NO_x, CO and particulates.

- CO₂ emissions are primarily related to energy use. Energy costs are a significant component of production costs and so it is standard practice in refineries and petrochemical complexes to minimise energy use
- SO₂ emissions are directly related to the sulphur content of the fuel oil/gas. Emissions can be monitored and controlled directly or by the indirect measurement of fuel sulphur content
- NO_x emissions depend on the type of fuel oil, fuel gas composition, operating temperatures and equipment design. NO_x emissions can be reduced through equipment revisions such as low NO_x burners
- CO emissions are relatively small and mainly arise in poorly controlled combustion processes. Excess oxygen content is frequently monitored to ensure efficient operation of fired heaters
- particulates are a function of fuel quality, equipment operation and burner design.

8.4.1.2 VOC emissions from point sources

Point source emissions of VOCs may arise from relief / safety valves, sample points, vents to atmosphere and breathing vents on tanks / storage vessels. In addition to generic techniques, the following may be used to reduce or eliminate emissions:

- process vessel relief valves and vents that are used to depressurise and flush equipment during emergencies and prior to / after maintenance are typically routed to a flare system or a gas vapour recovery system
- closed drainage systems are used to reduce emissions of aromatics to air, especially for systems with >1 % weight benzene or total aromatics content of >25 % weight
- total hydrocarbon emissions are rarely continuously monitored with in-line analysers as there are no continuous process vents.

Storage. Pygas and reformat feedstocks are generally supplied from upstream operations by pipeline directly to the production facilities or to intermediate storage. In many cases, the volume of intermediate storage is minimised to limit emissions and the handling of large feedstock volumes. Tanks may also be operated on ‘running-gauge’ mode (the same import and export rates) to limit the fluctuations in storage volume. Aromatic products are usually stored at atmospheric pressure in tanks exposed to ambient temperature. Nitrogen is sometimes used for inert blanketing. Internal floating roof tanks may be used to minimise emissions.

Loading and unloading. Emission of aromatics during loading/unloading operations to barges, rail cars, or tank trucks can occur from pipe connections if they are not evacuated before decoupling. Provisions are typically installed to allow purging of coupling and connections to aromatics recovery or flare systems. Some facilities for shipping aromatics via trucks, railcars or ships are equipped with vapour return systems to recover any aromatics from gaseous emissions during the loading. High efficiency vapour recovery systems (using a combination of physical processes such as adsorption, absorption and condensation) are capable of reducing benzene emissions to less than 5 mg/Nm³ (as a daily average during steady plant operation) [EC DGXI, 1990 #16].

The specific techniques adopted at two Dutch aromatics plants include [InfoMil, 2000 #83]:

- fuel gases, containing sulphur are treated in the nearby refinery by washing with amine solutions
- low NO_x burners in furnaces
- optimal control of burning processes and the use of fuel gases from the refinery and natural gas results in very low soot formation
- flare load is kept to a minimum and there is a flare gas recovery system (although care must be taken to avoid the crystallisation of aromatics in the system)
- storage tanks have double seals (floating roofs tanks) and internal floaters (fixed roof tanks containing light products) to limit the atmospheric emissions.

8.4.1.3 Fugitive VOC emissions

Fugitive emissions can be minimised by using the equipment design, fugitive loss assessment / measurement, and equipment monitoring / maintenance techniques as described in 5.3.1.3. In addition, if fluids have more than 1 % weight benzene content or more than 25 % weight aromatics content, pumps and compressors are fitted with double mechanical seals, or a process-compatible sealing liquid, or an enhanced mechanical sealing technology (e.g. single seal with a gas purge which achieves low leakage rates).

The specific techniques adopted at two Dutch aromatics plants are double seals on pumps (where required), the substitution of flanges/appliances/valves prone to leakage, and improved seals on compressors [InfoMil, 2000 #83].

Due to the low level of VOC emissions there is little continuous monitoring on aromatics plants. Continuous gas detectors may be used to detect the presence of hydrocarbons in the atmosphere (in order to prevent major hazard situations) but they have no role in the quantification of emissions. The detectors are normally calibrated to alarm at 20 % of the lower explosive limit of benzene.

8.4.2 Water emissions

Water is present in the hydrotreating of pyrolysis gasoline and the recovery of benzene and other aromatics. Typically, water that is used within the process units is controlled in closed-

circuits. All **process water** generated is treated before leaving the manufacturing site. Secondary and tertiary biological treatment typically follows local treatment or recovery in separators. Hydrocarbon materials recovered in these processes are normally recycled to the fuel system or, depending on the complexity of the configuration, recovered in adjacent processes.

Rainwater collected on site is normally processed through the site WWTP. Facilities may also be installed to retain heavy rainfall and fire fighting water and enable analysis prior to discharge.

Cooling water systems have the possibility of becoming contaminated and so systems are typically designed as closed-loop circuits. Preventive measures to avoid leaks in heat exchangers are normally handled through proper metallurgical design and monitoring of cooling water quality.

The inspection and repair of effluent collection systems is facilitated by the location of pipes and pumps above ground, and/or by placing pipes in accessible ducts. Such techniques are readily adopted on new plants but are not always feasible for retrofitting on existing sites.

In some systems, waste water containing high levels of aromatics is treated in an oily water collection system. This system allows segregation of water and hydrocarbon. The hydrocarbon phase is recovered and reprocessed in heavy hydrocarbon processing units such as a coker. The water phase is routed to a central WWTP.

Depending on the plant configuration and process waste stream generated, a separate facility may be operated to only treat streams containing high levels of benzene and other aromatic compounds. This process concentrates the benzene and aromatics for further recovery or processing either on-site or off-site. The recovered water is then routed to a central WWTP or returned to the refinery process.

Waste water from storage tanks is treated in common WWTP. The drainage systems for the tank are designed to prevent leaks and facilitate inspection and repair. Water drained from storage tanks may be processed through local water treatment facilities such as an API before routing to a biological WWTP.

Monitoring and controlling emissions to water is done primarily through sampling. Samples taken in facilities that ensure representative samples are required. There are many methods which can be used to measure oil contents or aromatics contents (including specific species identification such benzene) in water.

The specific techniques adopted at two Dutch aromatics plants include [InfoMil, 2000 #83]:

- the installations are placed on a concrete floor and spills are diverted to a central WWTP
- central waste water treatment including API-separation, dissolved air flotation and biological treatment
- carbon filters at the aromatics plant to limit the maximum load to the water treatment unit ('peak shaving')
- recycling of waste water streams to the aromatics plant or to the refinery
- elimination of cooling water discharge to waste water
- treatment of caustic scrubber waste water in spent caustic oxidiser and discharged into the WWTP
- grab samples of the effluent streams are taken twice a day and there is an on-line analyser for detection of BTX.

8.4.3 Solid wastes

The main techniques used to reduce or minimise solid wastes are [CEFIC, 2000 #112]:

- reduce at source
- recycle oily wastes
- recycle non-oily materials
- good housekeeping- e.g. inspection procedures will ensure that there are no leaks to soil or groundwater.

8.4.4 Process specific techniques

In addition to the techniques described above some aromatics processes use the specific techniques outlined below.

8.4.4.1 Pygas plants

8.4.4.1.1 Gasoline hydrotreaters

Air emissions: Normal operating pressures should allow the fuel gas produced in the process to be fed directly to the fuel gas system, which reduces the emissions from flaring. When the hydrogenation reactors have to be depressurised or shutdown (e.g. periodic catalyst regeneration) the flaring emissions can be minimised by first depressurising the reactor to the fuel gas system and then depressurising to atmospheric pressure by venting to the flare. Vent compression is sometimes used to fully recover some or all of the hydrocarbons vented to the flare system.

In units where fuel oil is used as the fuel source in regeneration furnaces, the burners can be based on Low-NO_x design. The use of continuous flue gas oxygen analysers to help optimise combustion conditions is not always justified for intermittent duties like regeneration but it is good operating practice to check conditions by occasional sampling of the flue gas.

Because of the severe impact of exposure to benzene-containing streams, all routine hydrocarbon sampling should involve the use of closed-loop samplers. Sample bombs are fitted into piped systems that allow the hydrocarbon stream to be flushed back into the process prior to isolating the sample bomb. The use of quick-release connectors for connecting the bomb reduces the release of hydrocarbons.

Water emissions: Emissions of hydrocarbons to water from the Gasoline Hydrotreater Unit are minimised by using interface level control systems on hydrocarbon vessels where water is withdrawn continuously from the process. For intermittent, manual draining of water from the process interface level indicators are also used to ensure that the hydrocarbon/water interface is always maintained inside the vessel. Interface level control should always be accompanied by a low-level alarm and trip.

Solid waste: Spent hydrogenation catalyst is removed from the reactors periodically and is normally returned to the catalyst manufacturer for recovery of the precious metal contained on the catalyst (normally nickel or palladium). This has economic reasons and environmental benefit. The inert catalyst support is sent to landfill.

8.4.4.1.2 Benzene heart cut/second stage hydrogenation/benzene extraction units

Air emissions: The second stage hydrogenation reactor(s) require periodic regeneration to restore catalyst activity. It is good practice to route the regeneration off-gas via the regeneration furnace firebox before release to atmosphere.

As in the Gasoline Hydrotreating Unit, the plant can be equipped with a closed drainage system to collect hydrocarbon slops (to be reprocessed) and closed loop sampling systems can be used for routine hydrocarbon sampling. All pumps with a benzene inventory can be fitted with double mechanical seals or can be seal-less to reduce fugitive emissions. Light ends from the second stage hydrogenation process can be routed to fuel gas rather than to flare.

Although the ultimate safeguard against over-pressurisation in the unit are the relief valves (which normally vent to a flare system) it is common practice to install high integrity 'heat-off' systems in benzene plants. These systems trip the heat input to distillation columns in the event of pressure increase in the equipment. This reduces emissions from flaring.

Water emissions: In extraction units operating below atmospheric pressure, the conditions are usually maintained by vacuum pumps. The vacuum seal pumps use extraction solvent as a sealing fluid to recover benzene from the vent gas and thereby reduce emissions to atmosphere and water. The inert gases are vented to atmosphere (through a water seal to remove solvent) or flared. During start-up and shutdown, intermediate product and equipment drains can be recycled to feed storage for later reprocessing.

Solid wastes: Similar to the Gasoline Hydrotreater Unit, spent catalyst from the second stage hydrogenation step can be returned to the supplier for reclamation of the active metal before the catalyst support is sent to landfill. Periodic regeneration of the extraction solvent produces a sludge that is collected and sent to a specialist contractor for incineration.

8.4.4.2 Toluene hydrodealkylation (HDA)

HDA technology is the gas phase hydrotreatment of TX cuts performed in severe conditions of temperature (up to 750 °C) and pressure (up to 60 bar), with or without catalyst, and in which C₇ and/or C₈ aromatics are converted to benzene and methane. Those conditions necessitate very high quality technology to avoid leaks, or other major hazards, and this has a positive benefit in environmental protection. This dual benefit also applies to other conversion processes used in the aromatics units, like toluene disproportionation or meta-xylene isomerisation which are also operated in severe conditions.

Air emissions: Except flue gas, there are no point sources emitting continuously to air in the HDA process, as all the process vents are directed to the fuel gas network. This fuel gas is exported in most cases or, in some cases, is re-used in the HDA process furnaces. Where justified by the hydrogen balance and economics, the reaction vents (essentially a methane and hydrogen mixture) can be separated into a hydrogen-rich gas (which is recycled to the reaction) and a methane-rich gas (which joins the fuel gas system or is directed to the hydrogen production). The separation can be accomplished by various techniques (e.g. pressure swing adsorption) and the choice of technique depends on the specific plant operating conditions and economics.

HDA units usually make use of shared flare systems, where the emergency vents (e.g. safety relief valve discharge) are connected. Beside the general measures to reduce the flared quantities and to improve the combustion quality, the amount of material sent to the flare network is reduced by maintenance and reliability programmes that avoid plant upsets and spurious trips.

Flue gas emissions are reduced by energy saving techniques such as heat recovery and reducing excess air by proper combustion monitoring and control. SO₂ emissions are usually not an issue, except in particular cases (high hydrogen sulphide content in fuel gas or use of liquid fuels). NO_x emissions from furnaces can be reduced using low NO_x burners. It is good practice to use the large amount of excess fuel gas although this capability is usually site specific.

Water emissions: The HDA reaction does not generate any water (or only traces) and no water is withdrawn continuously from the unit. The larger sources of water are the maintenance or upset operations (cleaning, spillages, rinsing) and rainwater.

Solid wastes: In the case of catalytic HDA, the only specific solid waste is the spent catalyst (typically chromium oxide on alumina). This waste is normally landfilled, usually after reclamation of the chromium.

Energy: The HDA process produces large amounts of methane-rich fuel gas that can be re-used.

8.4.4.3 Reformate plants

Reformate plants are the most complex units used for aromatics production. Depending on the unit design, there are options to produce varying combinations of final products such as benzene plus paraxylene, or toluene and/or ortho-xylene. The only specific techniques used on these units are:

Clay treatment: This removes the olefinic and diolefinic substances that could give rise to polymers likely to plug the equipment or to foul the catalysts. Spent clay consumption depends largely on the bromine index of the feed. A typical reformate has a bromine index of 100, leading to a clay consumption of 1 tonne per 10000 Mt feedstock. The clay may be steam cleaned to remove the aromatic components (and then landfilled) or subjected to further organics removal in a waste incinerator (to enable re-use in such applications as road construction [InfoMil, 2000 #83]).

Orthoxylene separation: Pure ortho-xylene as well as a meta + paraxylene fraction are usually separated from the mixed xylene streams by conventional distillation. The standard techniques are applicable for optimising the operating conditions to save energy and maximising the recovery of products.

Paraxylene separation: Two major processes are used at the industrial scale, using either crystallisation or selective adsorption. Both operations have applications although the most recent units tend to use adsorption. In the crystallisation process air emissions are essentially linked to fugitive emissions and to the possible leaks of cooling media (ethylene, propylene, carbon dioxide). In the adsorption process there are spent adsorbents for disposal by incineration. Neither process produces waste water.

8.4.4.4 Cyclohexane plants

For the hydrogenation of benzene into cyclohexane both vapour and liquid phase type processes are employed. The vapour phase process uses a fixed-bed noble metal catalyst of platinum or nickel that rarely needs replacement. The liquid phase process uses either Raney nickel or a soluble nickel catalyst and generates a small waste catalyst stream (a few tonnes per year) which is typically processed externally to reclaim the noble metal. As benzene hydrogenation is highly exothermic, a more specific technique for these processes is the maximum recovery of the reaction heat release (e.g. generation of steam for heating purposes).

The gaseous stream from the reaction is recovered in a fuel gas system, occasionally flared, resulting in no emission to air. The process is performed without water and there are no effluents other than spillage and rinse water for maintenance preparation. These are directed to a central waste water treatment unit.

8.5 Best Available Techniques

As explained in Chapter 6, BAT for a particular LVOC process is determined by considering the three levels of BAT in the following order of precedence: illustrative process BAT (where it exists); LVOC Generic BAT; and finally any relevant Horizontal BAT. The following techniques are BAT for the illustrative process of aromatics production.

8.5.1 Process selection

It is not possible to identify a BAT process since process selection is so dependent on the available feedstock and the desired products.

8.5.2 Air emissions

Aromatics production units are fairly energy-intensive and although use of energy is essentially still cost-driven, there is a growing tendency to incorporate more and more energy integration into modern designs. Energy integration applies to both the aromatics plant and its surrounding units, and also the efficient generation of energy and utilities as part of the energy integration programme. This is commonly accepted as BAT as it addresses the root cause of one aspect of air pollution, namely combustion emissions.

Typically, the only direct source of combustion emissions in aromatics processing is from the use of fired process heaters. For new furnaces, BAT is the use of Ultra Low NO_x burners (ULNBs) or, alternatively for larger furnaces, a catalytic De-NO_x (SCR) system. For existing furnaces, the BAT decision will depend on the feasibility of installing ULNBs or SCR considering the plant design, size and layout.

BAT is to minimise the VOC emissions at the design stage and due to the toxic properties of benzene particularly stringent controls are required. BAT is an appropriate selection or combination of the following techniques:

- BAT is to route routine process vents and safety valve discharges to gas recovery systems or, where this is not possible, to flare
- BAT is to use closed loop sample systems to minimise operator exposure and to minimise emissions during the purging step prior to taking a sample. The best closed loop sample systems route the sample loop back into the process
- BAT is to use 'heat-off' control systems to stop the heat input and shut down plants quickly and safely in order to minimise venting during plant upsets
- BAT is the use of closed piping systems for draining and venting hydrocarbon containing equipment prior to maintenance, particularly when containing more than 1 wt% benzene or more than 25 wt% aromatics. Ideally permanent piping is used to minimise the risk of exposure during the breaking of containment
- On systems where the process stream contains more than 1 wt% benzene or more than 25 wt% total aromatics, BAT is preferably the use of canned pumps or, where they are not applicable, single seals with gas purge or double mechanical seals or magnetically driven pumps

- When fugitive emissions are a particular concern (e.g. for occupational exposures reasons), the BAT for fugitive leaks from rising stem manual or control valves is fitting with bellows and stuffing box, or the use of high-integrity packing materials (e.g. carbon fibre)
- BAT for compressors is double mechanical seals, or a process-compatible sealing liquid, or a gas seal, or to be sealless.

BAT for the hydrogenation off-gases is combustion in a furnace with heat recovery facilities. Where there is a need or a market for pure hydrogen, the dealkylation off gases are to be subjected to hydrogen separation and use of methane as fuel.

BAT for the bulk storage of aromatics is either[EC DGXI, 1990 #16]:

- double seal floating roof tanks (not for dangerous aromatics such as benzene), or in fixed roof tanks incorporating an internal floating rood with high integrity seals
- fixed roof tanks which, for a given product or intermediate, have interconnected vapour spaces and vapour recovery or absorption at a single vent.

BAT for the loading or discharging of aromatics (or aromatics-rich streams) from road tankers, rail tankers, ships and barges is the use of closed vent systems (which include the vehicle itself) and where feasible the bottom-loading of road / rail tankers. BAT for the evolved vapours is connection to either a vapour recovery unit, burner or flare system.

8.5.3 Water emissions

The production of aromatics generally has few waste water arisings. BAT is to minimise waste water generation and to maximise waste water re-use.

Where high hydrocarbon levels still exist after full application of prevention and minimisation techniques, then BAT for waste waster exiting the battery limits is the recovery of hydrocarbons using, for example, steam stripping. BAT for the recovered hydrocarbons is either recycling to fuel or to other recovery systems in associated processes within the complex. BAT for the water phase is routing via an oily water separator (to recover hydrocarbons that do leave the battery limits) followed by biological waste water treatment.

8.5.4 Wastes

BAT for spent catalysts is recovery and re-use of the precious metal content and landfill disposal of the residual catalyst support.

BAT for oily sludges is incineration under carefully controlled conditions, with associated heat recovery.

Landfill and incineration are both BAT disposal methods for spent clay adsorbents. Clay adsorbents may need pre-treatment to reduce the organic content before landfill disposal.

8.6 Emerging techniques

The information exchange exercise has not identified any emerging techniques for this illustrative process.

9 ILLUSTRATIVE PROCESS: ETHYLENE OXIDE & ETHYLENE GLYCOLS

Although ethylene oxide (EO) and ethylene glycols (EG) can be produced separately, nearly all European installations produce a mix of the products on integrated plants. It is therefore logical to consider the products together in this section.

9.1 General information

Ethylene oxide is a key chemical intermediate to the manufacture of many important products. Most ethylene oxide product is converted into glycols, detergent ethoxylates, ethanol amines, glycol ethers and polyols (Figure 9.1). A very small portion of EO production is employed directly as a sterilising agent and as a fumigation chemical.

EO is toxic and a human carcinogen. The vapour is a strong irritant of the eyes and respiratory system. EO gas can decompose explosively, even without being mixed with air or an inert gas. Liquid EO polymerises easily in the presence of alkalis, mineral acids, metal chlorides, metal oxides, iron, aluminium or tin. These properties necessitate special arrangements for storage and handling.

Industrial production of EO started in 1937 with a Union Carbide process based on ethylene and air. In 1958, oxygen (rather than air) processes were introduced by Shell Development Company, and most European EO plants are now based on pure oxygen feedstock [CEFIC, 1999 #66].

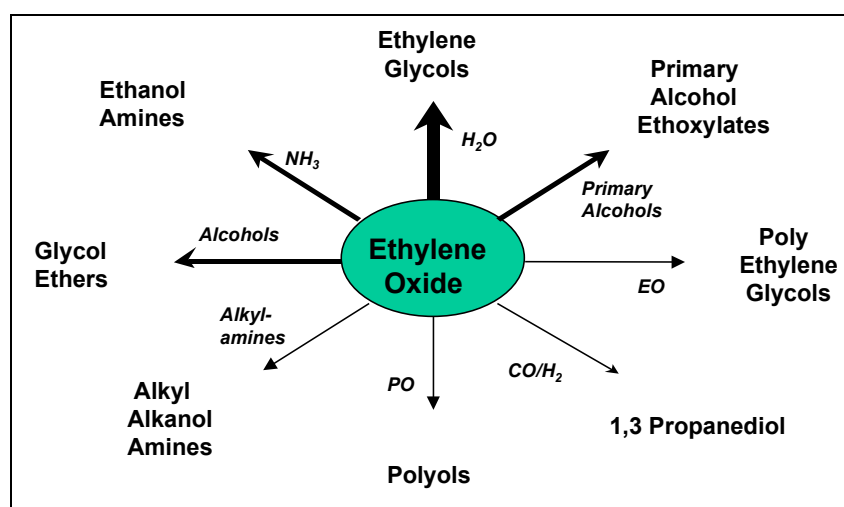

Figure 9.1: Ethylene oxide derivatives
[CEFIC, 1999 #66]

Ethylene glycols are produced by reacting EO with water. About 40 % of European EO production is converted into glycols, although globally the figure is about 70 % [CEFIC, 1999 #66]. The main product is mono ethylene glycol (MEG), but di ethylene glycol (DEG) and tri ethylene glycol (TEG) are also produced. MEG is mainly used for the manufacture of polyester fibres and polyethylene terephthalate (PET), and some as antifreeze in cooling systems (e.g. of motor vehicles). DEG is used in the fibre industry and as tobacco humectant and TEG is used in the manufacture of cellophane for food packaging. DEG and TEG are both used for gas drying.

Liquid EG causes slight eye irritation and can cause skin irritation with repeated contact. It is a stable, non-corrosive liquid and very hygroscopic.

9.1.1 Production capacity

The total European production capacity of EO (ex reactor) is about 3400 kt/yr, of which 2500 kt/yr is produced at the EU's 14 production sites (Table 9.1). North America, with 27 sites, has a production capacity of 5200 kt/yr, while Eastern Europe, with 4 sites, has a production capacity of 260 kt/yr [CEFIC, 1999 #66].

Country	Company	Location	EO Capacity (ex reactor) kt/yr
Belgium	BASF	Antwerp	350
	Ineos	Antwerp	350
France	BP Chemicals	Lavera	200
Germany	BASF	Ludwigshafen	200
	Clariant	Gendorf	160
	Erdölchemie	Köln	220
	RWE/DEA	Marl	150
Italy	Enichem	Gela	40
	Enichem	Priolo	30
Netherlands	Dow	Terneuzen	150
	Shell	Moerdijk	250
Spain	La Seda	Tarragona	100
Sweden	Akzo Nobel	Stenungsund	75
UK	UCC	Wilton	300
TOTAL			2500

Table 9.1: European ethylene oxide production sites
[CEFIC, 1999 #66]

9.1.2 Economic factors

EO has an extensive list of applications with main outlets in the European polyester and surfactants industry. Despite rationalisation of the European chemical industry over recent years there have been no new EO/MEG facilities built. This indicates the extent of competition with other regions in the world [CEFIC, 1999 #66].

EO/MEG are sold on chemical specification rather than performance-in-use and competition is therefore based heavily on price. MEG is a product that is easy to transport and this allows global trade. Europe is potentially vulnerable to imports from sources (e.g. the Middle East and Asia) where feedstock is cheap (mainly gas) and/or overheads are lower.

The market is global and exerts a constant pressure on the price of EO/MEG. Producers are pushed to reduce their production costs by continuous improvements and optimisation, or to reduce their margins. The prices for products and feedstocks are highly cyclical, mainly depending on global economic trends, often influenced by non-European factors.

Production costs. As with other processes, the cash cost of production includes variable costs (which are largely dependent on throughput) and fixed costs (such as operating labour, maintenance costs, and site overheads). Table 9.2 shows the cash costs for EO and EG for West European leader plants in 1997. The cost of feedstock is a dominant element in the cash costs, and accounts for most of the variable cost in EO / EG production. Product costs will therefore fluctuate significantly with the price of ethylene feedstock.

	Ethylene oxide	Ethylene glycol
Capacity (kt/yr)	225	186
Total Capital Cost (i.e. plant replacement cost) (£ million)	107	93
Net Variable Costs (including credit for by-products) (£/t)	329	252
Total Fixed Costs (£/t)	29	36
CASH COST (£/t)	358	288
Freight (£/t)	25	21

Table 9.2: Cash costs of production for ethylene oxide and ethylene glycols
[Environment Agency (E&W), 1998 #1]

Profitability. The cost curve for the total industry in which a plant competes is an important determinant in margin / profit, since commodity price is set by plants at the less competitive end of the cost curve. The steepness of the cash cost curve is an indicator of the potential for a competitive producer to make profit. A simple indicator of the steepness of the cash cost curve is the difference between the cash costs of leader and laggard plants (broadly, the best 20 percent and the worst 20 percent respectively of the regional cost curve). Cash costs for West European plants in 1997 are shown in Table 9.3.

	Leader	Laggard	Difference
	£/tonne	£/tonne	£/tonne
Ethylene Oxide	358	415	57
Ethylene Glycol	288	378	90

Table 9.3: Difference between leader and laggard cash costs
[Environment Agency (E&W), 1998 #1]

Cash cost margin histories for EO and EG shown in Figure 9.2 for West European leader plants. The shape of the curve represents differences in plant efficiency and scale, and also different feedstock sources. The margins fluctuate widely, largely synchronised with the industry business cycle. This indicates that changes in costs cannot be passed on to consumers. Both buyers and sellers are well informed in these markets and press for the benefits of over-supply or under-supply respectively.

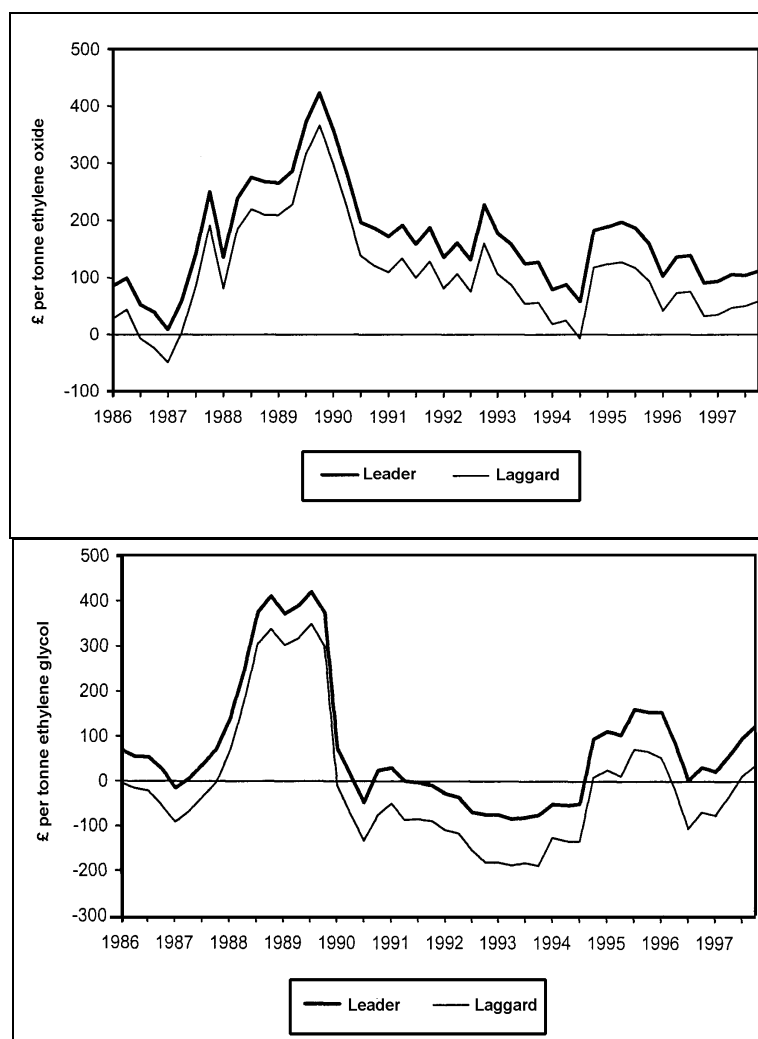
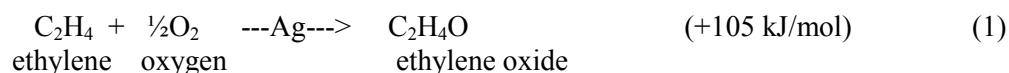

Figure 9.2: Ethylene oxide and ethylene glycol cash cost margin curve
[Environment Agency (E&W), 1998 #1]

9.2 Applied processes and techniques

9.2.1 Process chemistry

Ethylene oxide (EO) is formed by reacting gaseous ethylene and oxygen over a solid, silver containing catalyst. The exothermic reaction is carried out at elevated temperature (200 - 300 °C) and pressure (15 - 25 bar) with a residence time of one second [CEFIC, 1999 #66]. Very small amounts of acetaldehyde and formaldehyde may also be produced [Meyers, 1986 #74].



The main by-products are carbon dioxide and water, which result from the highly exothermic, full oxidation of ethylene. Some EO product may also be oxidised to carbon dioxide and water.

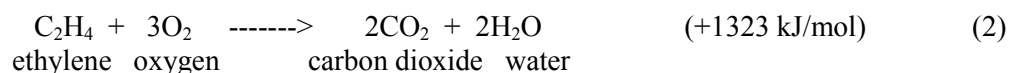

The ratio between the above two reactions defines the selectivity of the process (i.e. the amount of EO produced per amount of ethylene consumed), and is mainly determined by the type of catalyst used. The selectivity to EO is 65 – 75 % (for the air process) or 70 – 80 % (oxygen process) at an ethylene conversion of 8 – 10 % [Weissermel & Arpe, 1993 #59].

Mono ethylene glycol (MEG) is formed by the hydrolysis of EO with water at elevated temperature and pressure (150 - 250 °C, 30 - 40 barg). In commercial units the crude glycols mixture typically contains between 70 and 95 % wt of MEG.

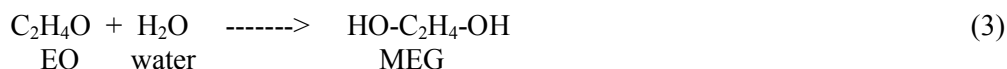

The main co-product in the MEG manufacturing process is **di ethylene glycol (DEG)**, which is formed by the reaction of MEG with EO.

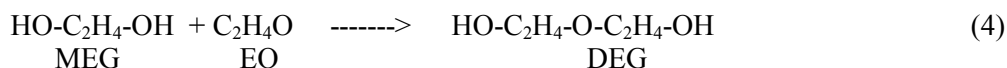

The DEG can react further again with EO (ethoxylation) to form **tri ethylene glycol (TEG)** and heavier glycols.

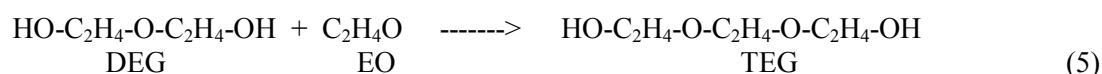

9.2.2 Production sequence

EO / EG plants can be designed for the production of:

- A. Glycols only (without high purity EO recovery)
- B. High purity EO only with a minimum production of unavoidable glycols
- C. A product mix of high purity EO and glycols on an integrated plant.

In practice, the third configuration is usually adopted because:

- MEG is the most important outlet for EO
- the hazardous nature of EO makes it easier to transport EG
- the EO process intrinsically forms glycols, which require work-up
- it provides efficient heat integration of the exothermic EO and energy consuming EG stages (the reaction of EO and water to make glycols is exothermic but the glycol plant is a net consumer due to the large heat demand of the evaporation and distillation stages).

Although there are a number of different EO/EG manufacturing process licensors, the process technologies are broadly similar and the unit operations can be grouped into four sections [CEFIC, 1999 #67]:

- Section 1: EO reaction, EO recovery and carbon dioxide removal
- Section 2: Non condensables removal and EO purification
- Section 3: Glycols reaction and de-watering
- Section 4: Glycols purification

These are shown schematically in Figure 9.3 for an oxygen process.

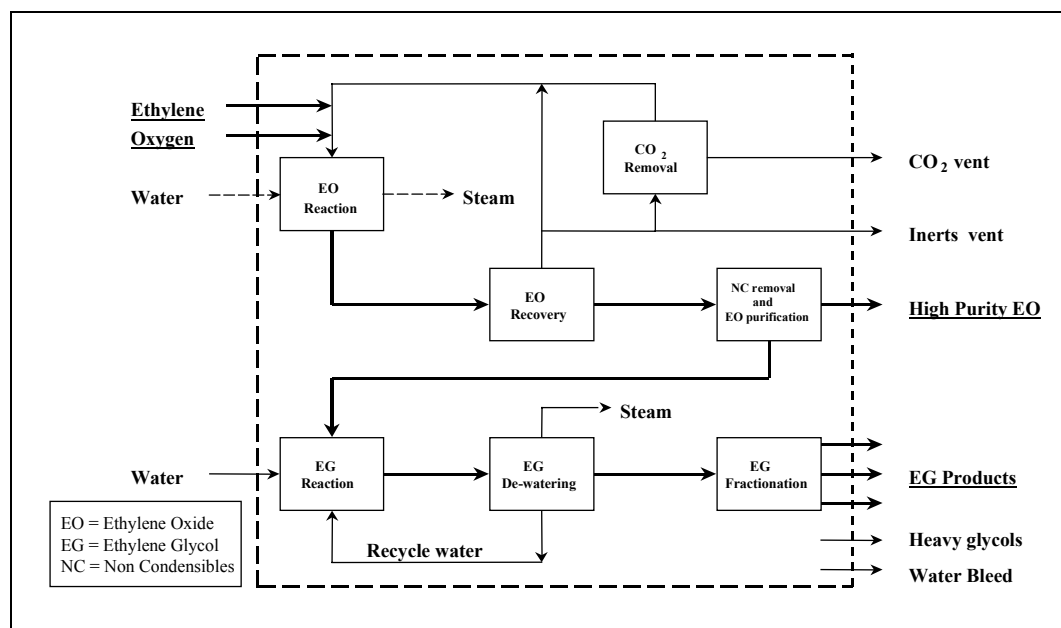

Figure 9.3: Schematic ethylene oxide / ethylene glycol process with pure oxygen feed [CEFIC, 1999 #67]

9.2.2.1 EO reaction, EO recovery and carbon removal

Ethylene oxide reaction

Feedstock ethylene is typically received by pipeline from a steam cracker. The oxygen can be provided by air (in an air-based process), but most modern processes are based on pure oxygen supplied by pipeline from an air separation unit (ASU).

The reaction between ethylene and oxygen is carried out in a multi-tubular, fixed bed type reactor, with a silver oxide catalyst in the tubes and a coolant on the shell side. The heat generated by the exothermic reactions is removed by the coolant, and is recovered by producing steam. The steam is used as a heating medium in various sections of the plant.

A large gas flow is circulated continuously through the EO reactors. Reaction products (EO, carbon dioxide and water) are removed from the circulating gas while unconverted oxygen and ethylene are recycled back to the reactor. There is fire and explosion risk with heterogeneously catalysed direct oxidation processes and the recycle gas therefore contains a diluent (e.g. methane) which allows operation at excess oxygen levels without causing a flammable mixture. A small amount of an organic chlorinated compound (typically ethylchloride or dichloroethane) is added to the recycle gas for catalyst performance control, and the chloride will end up in various product and effluent streams, partly as inorganic chloride (e.g. NaCl).

A vent stream is taken from the recycle gas in order to reduce the build-up of inerts like ethane, argon and nitrogen, impurities present in the ethylene and oxygen feedstocks. The inerts vent is typically used as fuel gas and burned (e.g. in a cracker furnace or steam boiler). Make-up ethylene, oxygen and diluent are added to the recycle gas loop.

EO recovery

EO is recovered from the gaseous reactor effluent by absorption in water. The aqueous EO solution from the absorber is concentrated in a stripper. The top stream of the stripper is a concentrated EO/water mixture that is routed to a section for non-condensables removal and EO purification. The bottom stream of the stripper is an EO free water stream that is cooled and returned to the EO absorber.

9.2.2.2 Non condensables removal and EO purification

The overhead stream of the EO stripper (EO/water mixture) is partially condensed and routed to a unit for removing traces of carbon dioxide, ethylene and other non condensables. The non condensables are routed back to the recycle gas loop while the purified EO/water mixture is routed to a unit for high purity EO recovery and/or to the glycols reactor.

Most plants in Europe have an EO purification unit in which high purity EO is recovered via distillation from the EO/water mixture that results after non-condensables removal. The EO product typically is chilled and routed to storage. The water is either recycled to the EO recovery section or routed to the glycols unit.

EO is a gas at ambient temperatures and is generally stored under a nitrogen blanket at approximately 10 °C, although it can be stored at ambient temperatures and elevated pressures. Vent gases from EO storage and other EO containing vent gases are typically routed to atmosphere via an absorber that recovers the EO and recycles it to the process. If not used immediately on site, EO is normally shipped in railroad tank cars that are loaded directly from plant storage tanks. The transfer generally occurs at about 350 kPa nitrogen pressure [Rentz, 1999 #114].

9.2.2.3 Glycols reaction and de-watering

Glycols are manufactured by feeding a mixture of EO and water to a reactor that is operated at an elevated temperature of typically 150 - 250 °C. Under these conditions reaction rates are fast and no catalyst is required. Sufficient residence time is provided to react all EO to full conversion. A reactor pressure of 30 - 40 barg is typically applied to avoid vaporisation of the EO. The reactor feed contains an excess of water in order to limit the adiabatic temperature rise and to enhance the selectivity to MEG. Typically the glycol products consist of 70 - 95 %w/w MEG, with the remainder being DEG and some TEG. All (100 %) of the EO feed is converted into glycols (either MEG, DEG, TEG or heavy glycols) although some of the heavy glycols may be subsequently incinerated.

The product stream from the glycols reactor contains the various glycol products and the excess of water. The excess water is removed by multiple effect evaporation with subsequent vacuum distillation and, after heat exchange, is recycled back to the glycols reactor. A bleed is taken from the water recycle to reduce the build-up of impurities. Low-pressure steam generated in this section is used as heating medium at various locations in the plant.

9.2.2.4 Glycols purification

The water depleted crude glycol stream is fractionated in a number of vacuum columns to recover the individual glycol products at high purity level. The glycol products are cooled and routed to storage. The bottom stream from the last vacuum column contains the heavier glycols and can be sold for further glycols recovery or sent for disposal (e.g. incineration).

9.2.3 Associated equipment and chemicals

A number of environment protection units and devices are typically integrated in EO/EG units, viz. [CEFIC, 1999 #67]:

- heat recovery from the EO reaction (reactor, off-gas)
- re-use of the water generated by the EO reaction for the glycols manufacture
- spent catalyst external treatment, for recovery of silver
- water scrubbing of EO containing vents
- multiple effect evaporation of the process water used for the glycols reaction
- heat recovery from the EG reaction
- site heat integration
- noise abatement devices.

The following auxiliary chemicals / process materials are typically used in the EO/EG manufacturing process [CEFIC, 1999 #67]:

- EO catalyst
- methane (used as diluent to increase the EO reactor flammable limit)
- ethyl chloride or dichloroethane (to prevent total oxidation of the ethylene)
- potassium carbonate solution (for carbon dioxide removal)
- sodium hydroxide (for pH control in the EO recovery section)
- antifoam agent
- nitrogen (for purging and inerting).

9.2.4 Other production routes

9.2.4.1 Ethylene oxide

Prior to development of the direct oxidation process, the **chlorohydrin route** was used for EO oxide production. This costly, two stage process involves the liquid phase reaction between ethylene and hypochlorous acid to form an ethylene chlorohydrin intermediate, followed by conversion to EO with hydrated lime. The EO selectivity is about 80 % [Weissermel & Arpe, 1993 #59]. Most of the chlorine is lost as unusable calcium chloride by-product. The use of transition metal chlorides as catalysts in the oxidation step also generates chlorinated by-products (such as EDC and chlorex) and these must be separated from the waste water (e.g. using rectification, stripping or extraction) before the biodegradable compounds are oxidised in a biological unit [CEFIC, 1999 #17]. Due to the high cost of chemical feedstocks (especially chlorine) and the considerable effluent load, this route was displaced by direct oxidation. The chlorohydrin route is still used for the industrial-scale preparation of propylene oxide, but rarely for EO.

Since the ethylene feedstock is expensive and 20 – 30 % is lost by destructive oxidation, there is constant research and development of catalyst selectivity. Improved selectivity brings not only higher EO yields, but also less heat generation. In turn, lower heat of reaction increases catalyst lifetime and increases ethylene conversion.

Due to its high fundamental selectivity, silver cannot be surpassed as the catalyst, but the catalyst support and the silver crystals can be optimised [Weissermel & Arpe, 1993 #59]. There have been proposals to use primary alkali metal salt co-catalysts with silver to increase the EO selectivity to over 80 % (and 94 % in the case of Rb/Cs) [Weissermel & Arpe, 1993 #59]. Alkali metal salts (e.g. caesium) have also been used in the regeneration of silver catalyst to extend catalyst life [Weissermel & Arpe, 1993 #59].

9.2.4.2 Ethylene glycols

Ethylene glycol can also be produced by glycolysis. Ethylene oxide is fed into ethylene glycols at 120 – 150 °C under slight excess pressure and in the presence of an alkaline catalyst [Weissermel & Arpe, 1993 #59].

Ethylene glycols are the major derivative of ethylene oxide so process development is aimed at:

- a. improving selectivity of the current EO route through the avoidance of total oxidation, minimisation of by-product formation, reduction of energy costs and prolongation of catalyst life
- b. developing new indirect routes based on ethylene. Routes include Ethylene Acetoxylation (ethylene is oxidised in the presence of acetic acid to glycol mono and di-acetates and then hydrolysed to EG) and Indirect Hydrolysis (EO is reacted with carbon dioxide to form an ethylene carbonate intermediate, which is then hydrolysed to EG and carbon dioxide)

- c. direct synthesis without the expensive EO intermediate. These may be based on ethylene, ethane or C₁ compounds (Synthesis gas, methanol, formaldehyde).

9.3 Consumption and emission levels

Much of the data on consumption and emission levels derives from CEFIC [CEFIC, 2000 #103], and they have used the following definitions / assumptions:

- ‘effluent streams’ are waste streams before treatment
- ‘emissions’ are streams that are discharged to the environment
- to facilitate data comparison between different plants, consumption and emission data are standardised in units per tonne of EO product (specified as EO produced in the EO reactor), or in units per tonne of EO equivalent fed to the glycol unit
- for confidentiality reasons, effluent stream data are anonymous and are presented in the form of two ranges: ‘All plants’ is the range within which all EU EO/EG plants are currently operating; and ‘Lowest 50 %’ is the operating range of those 50 % of plants with the lowest emission levels.

9.3.1 Raw material and energy consumption

9.3.1.1 Influence of catalyst selectivity

The selectivity of the EO catalyst used in the process can have a significant impact on raw material and energy consumption, and also on the production of gaseous and liquid effluents, by-products and wastes.

Catalyst selectivity, expressed as the number of moles of EO produced per mole of ethylene consumed, is a measure of the reactor performance and it shows how efficiently ethylene is used by the catalyst. Since ethylene costs dominate the production cost of EO (some 80 % of costs) and profitability is linked closely to ethylene prices, catalyst selectivity is a very important issue to the EO business.

Significant advances have been made in silver-based catalysts since Lefort’s original discovery in 1931, but silver remains the only known metal that can catalyse the oxidation of ethylene to EO with a commercially viable selectivity. Catalyst selectivities have improved from 50 % to around 80 %. This has been achieved by optimising the support materials and silver distribution, and by the use of promoters and moderators.

The importance of catalyst selectivity is shown in Figure 9.5 (its impact on raw material consumption) and in Figure 9.6 (its impact on the formation of carbon dioxide by-product).

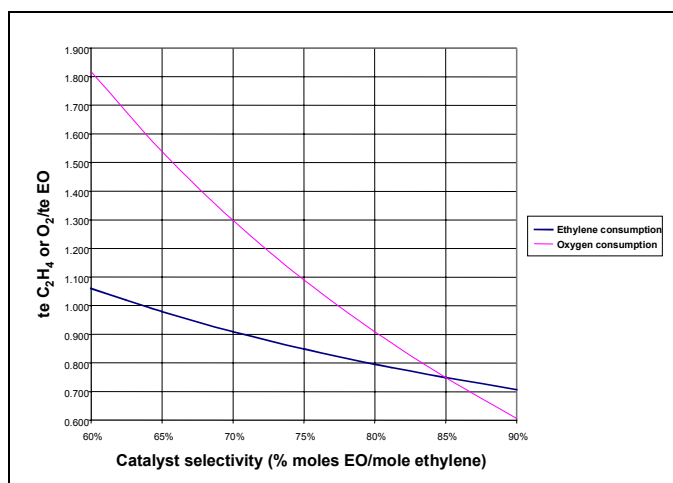

Figure 9.5: Impact of catalyst selectivity on raw material consumption
[CEFIC, 2000 #103]

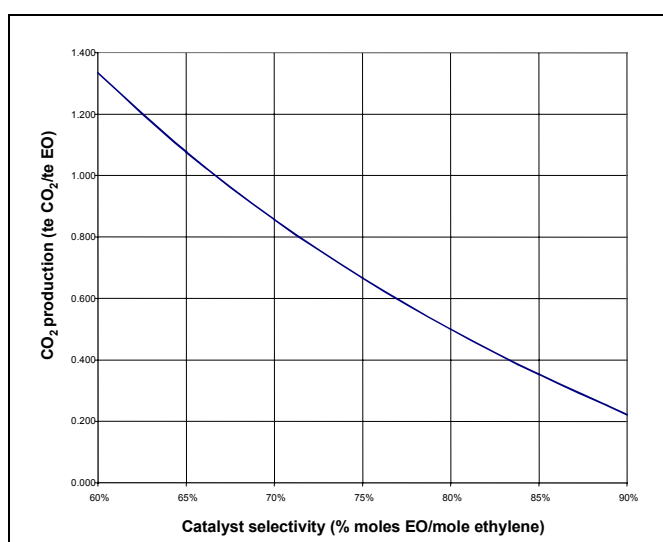

Figure 9.6: Impact of catalyst selectivity on carbon dioxide production
[CEFIC, 2000 #103]

Commercially available silver-based catalysts can be divided into two main categories and depending on overall economics (e.g. ethylene pricing, catalyst costs, site aspects) either type can be selected.

- the **high selectivity** catalysts have a higher initial selectivity, but they age relatively quickly and have to be changed more frequently (when selectivity falls below a critical level)
- the **high activity** catalysts have a lower initial selectivity, but have a longer life span as selectivity decline is slower and produces more heat (but also more carbon dioxide).

The amount of heat produced by the chemical reactions (epoxidation and combustion) is also determined by catalyst selectivity. The heat of reaction is used to generate medium pressure steam, usually for use as a heating medium on the process or site. Figure 9.7 shows that a lower catalyst selectivity involves a higher level of heat release and hence steam generation.

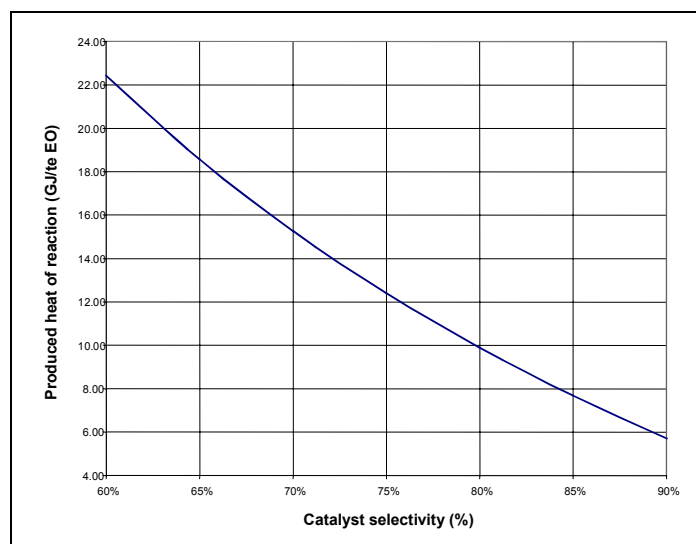

Figure 9.7: Impact of catalyst selectivity on ‘heat of reaction’ produced [CEFIC, 2000 #103]

The overall process heat balance (utilities steam import vs. medium pressure steam credits) is strongly dependant on such factors as the level of heat integration, design/technology and site situation. The process balance between reaction selectivity and steam production will be therefore decided by local circumstances.

9.3.1.2 Raw materials consumption

EO / EG production has two main raw materials in ethylene and oxygen (or atmospheric air). CEFIC advise [CEFIC, 2000 #103] that the unit costs and specific consumption of raw materials are kept confidential by producers because of their impact on competitiveness, and so only typical ranges are given in Table 9.4.

		Oxygen-based process	Air-based process
Ethylene	Selectivity (%)	75 - 85	70 - 80
	Consumption (kg ethylene/t EO ex reactor)	750 - 850	800 - 900
Oxygen	Consumption (kg oxygen/t EO ex reactor)	750 - 1100	

Table 9.4: Raw materials consumption of ethylene oxide / ethylene glycols processes [CEFIC, 2000 #103]

9.3.1.3 Energy consumption

The EO / EG process is both a consumer and a producer of energy. The EO section is typically a net energy producer and this is used to generate steam. The steam production depends on the EO catalyst selectivity, which in turn depends on the type and age of catalyst operating conditions.

The EG section is a net consumer of energy. A multi-effect evaporator system can be used in the glycols de-watering section to reduce energy consumption. Furthermore, the heat released in the glycols reactor is used to reduce energy consumption at glycols de-watering.

Catalyst selectivity and the relative sizes of the EO and EG sections influence the overall energy balance of the unit and define if a plant is a net steam importer or exporter. A low catalyst

selectivity gives a higher level of reaction heat release and steam generation in the EO reactor section, and thus a relatively low level of energy import (but a relatively large volume of carbon dioxide is formed). Conversely, a high catalyst selectivity involves a relatively high level of energy import.

Apart from generating steam, the process also generates a number of gaseous and liquid effluent streams that may be recovered as fuel for furnaces, power plants or steam boilers. Optimisation of the energy balance is therefore typically on a site-integrated basis. Since each European plant has different characteristics, it is difficult to give a meaningful range of energy consumption figures. Even when they are available, care is required in interpretation since lower energy consumption could mean that a plant is converting more ethylene into carbon dioxide. When comparing the air and oxygen processes, the energy consumption for the oxygen separation should be considered to ensure completeness.

9.3.2 Air emissions

In many cases, the gaseous effluent stream is flared, oxidised (thermally or catalytically), or sent to a boiler or a power plant, together with other streams, making it difficult to establish the true contribution of the effluent stream to the overall emission. The horizontal BREFs on waste water / waste gas treatment, and incineration may provide additional insight to the consequent emissions. Emissions from vents combustion have therefore been excluded from the data below.

A rather dated report [EC VOC Task Force, 1990 #116] gives average VOC arisings (prior to treatment) from ethylene oxide plants as 20.5 kg/t ethylene oxide product. In air-based plants VOCs mainly arise from the secondary absorber vent and the fractionating tower vent, whilst in oxygen-based plants the main sources are the absorber vent and the carbon dioxide absorption system. A comparison of VOC arisings is given in Table 9.5.

	Air-based plants	Oxygen-based plants
Ethane (kg/t EO product)	6	3
Ethylene (kg/t EO product)	92	0.1 - 2.5
Ethylene oxide (kg/t EO product)	1	0.5

Table 9.5: VOC arisings from ethylene oxide plants
[EC VOC Task Force, 1990 #116]

9.3.2.1 Vent from carbon dioxide removal unit

In the oxygen-based process, the overhead stream of the carbon dioxide stripper contains carbon dioxide and small amounts of ethylene, methane and EO. It is treated by physical treatment (enrichment for recycling of valuable substances), or by thermal or catalytic oxidation. The resulting stream is essentially pure carbon dioxide (and water) containing traces of hydrocarbons (methane and/or ethylene), and where possible is sold to a customer. More often the treated stream is vented to atmosphere. Effluent and emission levels are given in Table 9.6.

Parameter	Effluent stream pre treatment		Emission post treatment	
	All units	Lowest 50 % of units	All units	Lowest 50 % of units
Ethylene (kg/t EO ex reactor)	0.1 to 2			
Methane (kg/t EO ex reactor)	0 to 1			
Ethylene + methane (kg/t EO ex reactor)	0.4 to 3	0.4 to 1	0* to 3.1	0* to 0.2
* In the case of treatment by oxidation the emissions are considered to be zero				

Table 9.6: Carbon dioxide removal vent before and after treatment
[CEFIC, 2000 #103]

9.3.2.2 Inerts vent

The inerts purged from the gas loop form a large stream in the case of the air-based process but are minor when the oxygen-based process is used. In the oxygen based process, the inerts vent consists mainly of hydrocarbons. Small amounts of ethylene dichloride, which is used in small quantities to modify the oxidation reaction, are also [Environment Agency (E&W), 1999 #7]. This stream is treated by flaring or passes to the fuel gas network for combustion. The effluent and emission contents are given in Table 9.7.

	Effluent stream pre-treatment		Emission post-treatment	
	All units	Lowest 50 % of units	All units	Lowest 50 % of units
Total vent flow (kg/t EO ex reactor)	2.5 to 120			
Hydrocarbon content (% wt)	30 to 80			
Hydrocarbon load (kg/t EO ex reactor)	2 to 36	2 to 10	0* to 16	0*

* In the case of treatment by oxidation the emissions are considered to be zero

Table 9.7: Inerts vent before and after treatment
[CEFIC, 2000 #103]

9.3.2.3 VOCs from cooling towers

In some plants, the water used to absorb EO is cooled down in a cooling tower. As this water contains some traces of organics, the air from the cooling tower contains VOCs (between 0.015 to 0.6 kg VOC/t EO ex-reactor [CEFIC, 2000 #103]). There is no direct treatment of the gas stream leaving the cooling tower and cooling tower vapours are vented to atmosphere. VOC emissions are instead reduced by improving the stripping of the absorbing water. The final emission to atmosphere is <0.6 kg VOC/t EO ex reactor (and usually less than 0.03). However, this emission quantification is difficult because the VOC content in the air stream is close, or even below the detection limit, and the organics content in the absorbing water shows only little variation from the inlet to the outlet of the cooling tower.

9.3.2.4 Scrubber off-gas

The water scrubber that recovers EO from process streams has an overhead stream of nitrogen that contains some EO. This stream is vented to atmosphere. The range of EO loads for all units is 0.1 to 40 ppm wt, and the lowest 50 % of units contain 0.1 to 3 ppm wt [CEFIC, 2000 #103].

9.3.2.5 Storage tanks

Losses from storage tanks are assumed to occur only because of displacement during filling operations. In the absence of specific emission prevention / abatement, storage and loading are reported to generate 2.6 kg EO/t product [Rentz, 1999 #114].

9.3.2.6 Fugitive / non-channelled emissions

Fugitive / non-channelled emissions of EO and EG will arise from the process, but they are difficult to quantify and no data is provided. They will arise from non-channelled emission points, reactor analyser vents and from maintenance activities. The fugitive emissions of EO tend to be extremely low, because much attention is paid the minimisation of occupational exposure. Fugitive emissions for an average ethylene oxide plants have been estimated to range from 148 to 188 kg/day [EC VOC Task Force, 1990 #116].

9.3.3 Water emissions

In many cases, the aqueous effluent streams are treated in central facilities together with other streams, and this makes it difficult to establish the true contribution to the overall emission. CEFIC have assumed that, on the basis of the high biodegradability of glycols, then bio-treatment will reduce the organic load by at least 90 %.

Effluent from ethylene oxide recovery section. Combined glycols and/or salt streams arise from the EO recovery section. This stream is either in large volume with a low organics content, or a small volume highly concentrated stream. High concentration streams are either sold as a by-product or incinerated, but low concentration streams require effluent treatment. The low concentration stream prior to treatment may have a flow rate in the range of 200 - 2300 kg/t EO ex reactor, and a Total Organic Carbon content of 0.3 to 2 % wt (1 - 20 kg TOC/t EO ex reactor) [CEFIC, 2000 #103]. The stream is preferably treated by a concentration stage to produce a concentrated organic phase that can be sold or incinerated. Alternatively the stream can be mixed with other effluents and biologically treated (with an assumed minimum efficiency of 90 %) prior to discharge to a water body:

Process effluents. The total plant effluent stream is generated at a rate of 450 - 1100 kg/t EO ex reactor and has a Total Organic Carbon (TOC) content of 200 - 4000 ppm wt [CEFIC, 2000 #103]. The specific TOC content is 0.1 to 4 kg TOC/t EO ex reactor (for all units) and 0.1 - 0.22 kg TOC/t EO ex reactor (for the lowest 50 % of units) [CEFIC, 2000 #103]. The stream is mixed with other streams and treated biologically (with an assumed minimum efficiency of 90 %). The final emissions may contain 0.01 - 0.4 kg TOC/t EO ex reactor (all units) and 0.01 to 0.022 (for the lowest 50 % of units) [CEFIC, 2000 #103].

Discontinuous waste water. The rinsing of process equipment, for example prior to maintenance, creates a weak stream of hydrocarbons. The number of cleaning operations is highly dependent on the maintenance regime and the frequency of discharge may range from ten per year to once every five years. This stream is typically directed to a central waste water plant for biological treatment.

9.3.4 By-products and wastes

Effluent from ethylene oxide recovery section. Any stream concentrated in hydrocarbons can be either sold as a by-product, or incinerated as a waste. The rate of arising is in the range 0.5 - 10 kg/t EO ex reactor, and the typical hydrocarbon content is 40 % wt TOC.

Heavy glycols. The last column of the glycols separation unit generates a bottom stream of heavy glycols (oligomers) at the rate of 2 - 100 kg/t EO (2 - 5 kg/t EO for the lowest 50 % of units). The stream is usually sold to customers, but may be incinerated.

Spent catalyst. The EO catalyst loses its efficiency over the time and it is periodically changed (typically every 1 to 4 years). The rate of generation is 0.12 - 0.8 kg/t EO (0.12 - 0.3 kg/t EO for the lowest 50 % of units). The catalyst is sent to reclaimers for recovery of the metallic silver content. The inert, inorganic support for the catalyst requires landfilling once the silver has been recovered.

9.3.5 Example plants

In Table 9.8 to Table 9.12 there is information on specific EO/EG plants within Member States. The collection of this information has not been co-ordinated according to any pan-European protocol although there may have been protocols at Member State level. The data are presented

in a variety of formats and should be seen as real-life examples of plant performance. Accurate interpretation of the data may require further information from the originating Member State.

	Plant 7, Internal No.47	Plant 8, Internal No.B11	Plant 9, Internal No.B4
Production capacity	200 kt/yr EO	160 kt/yr EO	300 kt/yr EO
Waste gas	Maximum emission concentrations as 1/2 h averages. Methane: 250 mg/m ³ . Ethylene: 115 mg/m ³ . EG: 30 mg/m ³ . EO: 5 mg/m ³ . Catalytic waste gas treatment (90 %)	Measured emissions (1/2 h - average). Methane: max. 280 mg/m ³ (0.08 kg/t). Ethylene max. 200 mg/m ³ (0.1 kg/t). EO: max. 1 mg/m ³	Measured emissions (1/2 h - average): NOx max. 500 mg/m ³ . CO max. 100 mg/m ³ . Ethylene max. 11 mg/m ³ . Formaldehyde max. 5 mg/m ³ .
Waste water		<u>Raw data:</u> COD = 1.2 kg/t EO Amount of waste water: 1.34 m ³ /t. COD: 500 – 1500 mg/l	Stream 1: <u>Raw data:</u> COD 3600 mg/l (1.9 kg/t). <u>After final treatment:</u> amount = 0.53 m ³ /t with COD < 0.18 kg/t Stream 2: <u>Raw data:</u> COD 6180 mg/l (2 kg/t). <u>After final treatment:</u> amount=0.32m ³ /h, COD <0.2 kg/t.
Solid wastes		4 kg/t Product (distillation residues)	120 tpa used catalyst with Ag-components (recycling). 0.15 tpa used catalyst with Pd-components (recycling). 3 tpa reaction and distillation residuals (combustion). 3.5 tpa used catalyst (chemical and physical recycling).
Energy		Steam input: 3 – 4 t/t product	<u>Input:</u> 3.2 MW electric power. 20 t/h 15 bar steam. 90 t/h 5 bar steam. 8 kg/h heating gas

Table 9.8: Emissions from ethylene oxide plants in Germany [UBA (Germany), 2000 #91]

Source	Type	Pollutant	Producer A (250 kt/yr) Emission factor (kg/tonne EO)	Producer B (250 kt/yr) Emission factor (kg/tonne product)
EO purification	Point source	EO	0.001	0.038
		Ethylene	0.3	0.14
		Methane	0.25	1.3
		Total NMVOC	0.3 (excl methane)	0.18 (excl. methane)
EO plant	Fugitive	EO	0.01	0.001
		Ethylene	0.003	0.03
		Methane	0.004	0.006
		Total NMVOC	0.03	0.03
EG plant	Point source	Ethylene	None	0.006
		Acetaldehyde		0.0014
EG plant	Fugitive	None	None	None
Furnaces	Flue gases	NOx	None	
		CO		
		VOC		0.11

Table 9.9: Emissions to air in 1998 from two ethylene oxide plants in The Netherlands [InfoMil, 2000 #83]

Source	Destination	Pollutant	Emission factor (kg/tonne of product)
Producer A EO + EG plant	Public sewer	glycol	1.7
Producer B EO plant	WWTP	TOC	0.05
Producer B EG plant (stripped process water)	WWTP	TOC	0.2

Table 9.10: Emissions to water in 1998 from two ethylene oxide plants in The Netherlands [InfoMil, 2000 #83]

Pollutant	Effluent concentration (mg/l)	Reduction efficiency (%)
Aromatics	< 0.1 mg/l	> 95 % (typical 99 %)
TOC	25 mg / l	60 – 70 %

Note: Central waste water treatment facility treats effluents other than from the EO/EG plant.

Table 9.11: Efficiency of central waste water treatment plant in Dutch plant [InfoMil, 2000 #83]

Source (Producer B only)	Destination	Type of hazardous waste	Emission / generation factor (kg/tonne of product)
EO reactors	External regeneration	Catalyst	0.14
Glycol Purification	Basic material for external industry	Liquid with heavy glycols and salts	0.03
Glycols plant	Liquid organics		0.0002

Table 9.12: By-product / waste generation by Producer B in The Netherlands [InfoMil, 2000 #83]

A Swedish EO plant has an annual capacity of 80000 tonnes. In 1998, 66200 tonnes were produced from 53650 tonnes of ethylene and 58157 tonnes of oxygen. The 1998 VOC emission was 1.6 tonnes, although several tonnes are estimated to have been lost to the atmosphere through incidents and fugitives. The VOC emission equates to >0.03 kg VOC / tonne feedstock. A nearby gas producer uses part of the carbon dioxide by-product and 16566 tonnes were released in 1998. The EG plant has an annual capacity of 22000 tonnes and 2273 tonnes were produced in 1998. The 1998 glycol emission to water was 6.0 tonnes and this equates to 2.3 tonnes of TOC [SEPA, 2000 #76].

9.4 Techniques to consider in the determination of BAT

This section describes a variety of design principles that could be applied to new EO/EG facilities, as well as operational, minimisation, and treatment techniques that can improve the environmental performance of existing facilities. There are also a number of non-technical factors that can influence the choice of BAT on an EO/EG plant and these are discussed.

9.4.1 Process design principles

9.4.1.1 Ethylene oxide production process

The manufacture of EO has progressed significantly since the original process route via ethylene chlorohydrin. In the 1930s a manufacturing route was developed based on catalytic, partial oxidation of ethylene, and this direct oxidation process is superior in both its production

and environmental performance. All EO plants in the EU now use the direct oxidation process; either with air or pure oxygen.

The air oxidation process has higher ethylene consumption, higher carbon dioxide production and produces larger amounts of off-gas. The oxygen process requires pure oxygen as a feedstock, and energy is used in the manufacturing of the oxygen, but they allow the recovery of pure carbon dioxide that can be re-used (e.g. for inerting) or sale.

The first generation of EU plants used air, but many of these plants have been replaced by, or converted into, plants using pure oxygen. Newly built EO plants now all use pure oxygen feed, which is more economically attractive. The additional costs of pure oxygen consumption are more than compensated by reduced ethylene use and lower capital requirements per tonne of product.

9.4.1.2 Ethylene glycol production process

As the EG production process is based on the hydrolysis reaction of EO, it uses a large water excess which is further separated and recycled to the EO hydrolysis step. MEG, DEG and heavier glycols are simultaneously produced, the relative amount depending on the water excess. Higher water: EO ratios result in lower co-production of heavier glycols, but require more energy for glycol de-watering. The economic optimum will depend on local conditions.

9.4.1.3 Storage facilities

As a safety precaution, ethylene and oxygen are usually stored outside of the EO/EG unit, and fed by pipe to the process unit. EO is typically stored in pressure vessels under a nitrogen blanket and may be refrigerated. The nitrogen serves as a diluent in order to keep the vapour phase outside the explosive area. Tank vents are typically routed to a water scrubber that ensures nearly 100 % EO recovery. EG and heavier glycols are stored in atmospheric vessels since glycols have a lower vapour pressure and emissions to air are negligible.

9.4.1.4 EO loading facilities

Systems for loading EO into trucks or railcars are typically equipped with vapour return systems in order to minimise the release of vent streams containing EO. Alternatively, EO containing vent streams are subjected to an appropriate treatment technique, such as water scrubbing, in order to prevent EO emission to atmosphere. Emissions of EO during loading operations are minimised by properly purging relevant piping and coupling connections before decoupling. Purge vents are subsequently treated (typically by water scrubbing) in order to recover the EO.

The design and operation of EO storage / loading facilities are aimed at minimising the risk of explosions or runaway reactions that could compromise EO containment and these same measures have major environmental benefits. An important area is avoiding the ingress of air, which could form an explosive vapour mixture with EO, or of other impurities that are reactive with EO or that could catalyse EO runaway reactions.

9.4.2 Raw material consumption

The main raw materials used in the EO/EG process are ethylene and oxygen (either pure or as air). By far the most important factor causing raw material consumption to be higher than stoichiometric consumption is the limited selectivity of the EO catalyst. Significant progress has been made to improve catalyst performance reducing raw material losses by more than 50 % and further efforts are continuing, mainly driven by economic factors.

Catalyst selectivity gradually decreases over time resulting in increased raw material consumption per tonne of EO produced. Conceptually, a lower raw material consumption over the lifetime of the catalyst could be achieved by more frequent catalyst change out. However, the gains from higher catalyst selectivity need to be balanced against factors like the cost of new catalyst, the cost of installing the new catalyst, and the production loss resulting from downtime during catalyst change out. More frequent catalyst replacement would also lead to more spent catalyst.

Minor (at least in the oxygen based process) raw material losses arise from the need to bleed inerts like argon and ethane from the recycle gas. Techniques do exist to recover ethylene from the inerts vent (e.g. membrane separation, absorption/desorption), but application of these techniques may not always be economically feasible, e.g. because of the small vent volume concerned or the low ethylene concentration involved (in air based plants).

Hydrocarbon losses may also occur from the incineration of (possibly salt containing) heavy glycols streams. Such losses can be minimised by maximising glycols recovery before incineration (maybe by a third party). Other hydrocarbon losses, such as via the water effluent and resulting from cleaning operations, are relatively small compared to the other losses mentioned above.

9.4.3 Utilities consumption

Electricity and steam are the main utilities used on EO/EG plants, and they usually represent a considerable share of production costs.

The interrelationship between EO catalyst selectivity and heat balance mean that, the more efficient the catalyst, the less steam is produced in the EO reactors. The plant energy balance also depends on the relative sizes of EO and EG sections. If the EO/EG unit is a net steam exporter, the way to re-use this energy in the complex becomes of prime importance. To a certain extent the EO/EG unit may play the role of a boiler plant for the site and this may hinder the use of more selective catalysts which would allow less steam to be exported.

The steam consumptions inside the core EO/EG plant are mainly due to distillations, and sometimes to turbines driving the gas compressors. The methods for minimising the steam consumption of distillation are well known when designing a new unit. For existing distillation columns, retraying and repackaging techniques can be used, and technologies that often have a minor impact on the steam consumption are principally used to debottleneck the capacity.

Unless steam turbines are used, the major electricity consumer of an EO/EG unit is the recycle gas (oxygen process) or air (air process) compressor. The usual ways to reduce the energy consumptions of compressors are applicable (i.e. efficient design, reduction of pressure drops, particularly of the catalytic bed by use of an appropriate support). Some minor improvements can also be obtained through the use of gas seals.

9.4.4 Air emissions

Almost all the organic air emissions from EO/EG plants can be prevented, re-used, recycled or combusted, in the following manners.

9.4.4.1 Carbon dioxide vent

Carbon dioxide is produced as a by-product during the manufacture of EO and has to be removed from the system to prevent build up. Carbon dioxide is removed by absorption in a hot carbonate solution. Carbon dioxide is then stripped from the carbonate solution by means of

lower pressure and heat. The gaseous overhead stream from the carbon dioxide stripper is vented to air after partial condensation of water (if needed). The vent stream is mainly composed of carbon dioxide and water, but also contains minor quantities of ethylene and methane.

The carbon dioxide stream can be minimised by [CEFIC, 2000 #104]:

- reducing the formation of carbon dioxide through the development of EO catalysts
- selling the carbon dioxide as a commercial by-product (only where suitable outlets for the treated stream exist)

The carbon dioxide stream can be treated by [CEFIC, 2000 #104]:

- recovering ethylene and methane from the fat carbonate solution before stripping out the carbon dioxide. 'Flashers' can recover a significant amount of the absorbed ethylene and methane from the carbonate solution prior to carbon dioxide removal in the carbon dioxide stripper. The overheads of the flasher can be recycled back to the process
- removing ethylene and methane from the carbon dioxide vent. Either thermal or catalytic oxidisers represent techniques for abatement of the ethylene and methane as they ensure an overall VOC destruction of roughly 90 %. The vent stream after treatment is either routed to atmosphere or recovered for further use (the carbon dioxide customer may further purify the stream).

9.4.4.2 Inerts vent

A purge is taken from the recycle gas to reduce the build-up of inerts and this is vented to air after treatment. In the **oxygen based process** the vent consists mainly of hydrocarbons (ethylene, methane etc.) and inerts (mainly nitrogen and argon impurities present in the ethylene and oxygen feedstock), but the exact type and content depend on the inert used.

The techniques to treat the inerts vent stream include [CEFIC, 2000 #104]:

- the hydrocarbon content of the inerts vent gives it value as a fuel and it is often used as a fuel gas in site boilers. In these cases, the most significant potential emissions are NO_x and CO, mainly dependent on the burner technology (Low NO_x burners), and combustion control (advanced control systems). The use of the inerts vent as fuel gas is generally BAT
- where the inerts vent has low value as a fuel, the stream is routed generally to a common flare system. Ground flares give higher incineration efficiencies than elevated flares, but their capacity is lower. Elevated flares have the disadvantage of noise and visible light.

In **air based process** a large volume of nitrogen enters the process via the air feed. Part of the recycle gas is routed to a second EO reactor to convert the ethylene present and the resulting EO is recovered via absorption in water. There is likely to be a fractional percentage of ethylene in the vent gas and this can be removed by catalytic oxidation. In addition to destroying the ethylene, heat is generated which increases the power available for recovery in an expansion turbine. The remaining gases (mainly nitrogen and carbon dioxide) are vented to atmosphere.

9.4.4.3 VOC from open cooling towers

In EO units, the EO produced in the reactor is absorbed in water in an absorber or scrubber. The resulting EO-solution is stripped, cooled and re-routed to the absorber. The cooling can be achieved in closed or open cooling towers. Open cooling towers are usually more efficient, especially in hot climates, but they result in trace emissions of VOCs and mechanical entrainment of compounds with low volatility. For existing units, the application of minimisation measures can greatly reduce the VOC emissions from open cooling systems. These techniques include [CEFIC, 2000 #104]:

- reduce the VOC content of the stream that emanates from the bottom of the EO stripper by:
 - use part of the hot bottom stream in other process heat exchangers or reboilers as part of energy integration schemes
 - improve the operating conditions and monitoring of the EO stripper operation to: ensure that all EO is stripped out; provide online process analysers to check that all EO has been stripped out; and provide adequate protection systems to avoid accidental EO slippage
 - minimise the organics content in cycle water by upstream avoidance measures and by optimising quenching systems.
- closure of open cooling towers. Due to changes in water balance, the conversion of open cooling towers to closed cooling towers entails substantial process changes in the EO unit and connected systems (e.g. glycol recuperation). As a consequence of closing cooling towers, part of the VOC is routed to other emission points to be treated in their own separate way. The cost of closing open cooling towers depends on whether or not additional water chillers are required (this is more likely in hotter climates). Chillers use large amounts of energy, require careful operation and are maintenance intensive, so there is a balance between environmental benefit and economic cost.

9.4.4.4 VOC from scrubbing EO off gases

EO containing vent gases may originate from various sources in the process, such as: flashing steps in the EO recovery section, the EO purification section, process analysers, and safety valves. They may also originate from associated activities, such as EO storage or buffer vessels, and EO loading / unloading operations. Apart from EO, these vent gases typically contain non-condensables like argon, ethane, ethylene, methane, carbon dioxide, oxygen and/or nitrogen.

The techniques to minimise the EO stream include [CEFIC, 2000 #104]:

- most of the individual process vent streams contain valuable components (ethylene, methane) in addition to EO. The streams are usually routed to a scrubber that is operated at the lowest possible pressure so that all process vents can be routed to it. EO is recovered by absorption in water, and recycled back to the process. The scrubber overheads stream is compressed and also recycled back to the process, leaving no residual effluent stream or emission to atmosphere
- some EO containing vent streams do not contain other valuable components (e.g. EO storage and EO loading / unloading operations consist mainly of nitrogen). Such streams are typically vented to atmosphere after treatment. Techniques to minimise these streams include: providing pressure balancing lines between EO tanks, and installing vapour return systems during EO loading / unloading.

The techniques to treat the EO stream include [CEFIC, 2000 #104]:

- EO containing vent streams that are unattractive to recycle back to the process are typically treated by water scrubbing. Where plant configuration allows, the recovered EO can be recycled back to the process or to a biotreater while the remaining inerts (typically nitrogen) are vented to atmosphere
- if no vent compressor system is available to recycle the vents containing non-condensable hydrocarbons back to the process, such vents can also be sent to a flare or incinerator.

9.4.4.5 Fugitive emissions

In addition to normal sources such as (control) valves, pumps and flanges, the EO plant itself is a potential contributor to fugitive emissions since volatile organic hydrocarbons are present in relatively large quantities at elevated pressures. The VOC releases consist mainly of EO, ethylene, and methane (where methane is applied as diluent in the recycle gas loop).

Due to its toxic and carcinogenic nature, threshold limit values for EO in ambient air are very low (in the order of 1 ppm). For occupational health reasons extensive measures have been taken by the industry to prevent EO releases, including fugitives, or to detect them at an early stage such that remedial measures can be taken promptly. In addition to the generic techniques described in 5.3.1.3 the specific techniques to minimise fugitive emissions may include [CEFIC, 2000 #104] [SEPA, 2000 #76]:

- careful material selection for seals, O-rings, gaskets, etc. in EO duty
- use of double seals or tandem seals on pumps in EO duty or use of canned or magnetic drive pumps
- installation of sensitive EO detection systems for continuous monitoring of ambient air quality (these systems also detect ethylene)
- application of metal strips around flanges with a vent pipe sticking out of the insulation that is monitored for EO release on a regular basis
- monitoring of EO plant personnel for EO exposure (since exposure means emission).

9.4.4.6 Storage

At most facilities, displaced vapours from the filling of tank cars and storage tanks are either recycled to the process or scrubbed prior to incineration or flaring. When the vapours are scrubbed, the liquid effluent from the scrubber is routed to the desorber for ethylene oxide recovery. Emissions of ethylene oxide from storage and loading are assumed to be nearly zero if either control approach is used. However, one producer reports 39 te/a of ethylene oxide emissions from storage and loading when using a caustic scrubber for control of emissions. In theory, zero emissions are achievable for storage and loading where control is carried out by recycling or scrubber plus incineration or flaring for air oxidation and aqueous scrubber for oxygen oxidation [Rentz, 1999 #114].

A rather dated cost for VOC reduction by catalytic incineration is 333 Canadian \$ / tonne VOC (at 98 % reduction efficiency) [EC VOC Task Force, 1990 #116].

9.4.5 Water emissions

9.4.5.1 Liquid effluent from EO recovery section

Where water is used in the EO recovery section as an absorbent, EO is partially hydrolysed to EG. In order to reduce the accumulation of glycols a bleed stream is taken. This stream is concentrated in organic compounds; predominantly mono ethylene glycol, di ethylene glycol and higher EG, but also minor amounts of organic salts.

The glycol formation in the EO recovery section can be reduced, to a certain extent, by modifying the temperature and/or residence time conditions of the EO-containing absorbent. The effluent stream can also be routed to a glycol plant (if available), or a dedicated unit for recovery of (most of) the glycols and (partial) recycle of water back to the process.

The stream can be treated in a biotreater as EO in waste water streams readily biodegrades. Even without this rapid biodegradation, EO undergoes rapid breakdown by hydrolysis (under neutral conditions EO has a half-life of 8 - 15 days, depending on temperature, and this is further reduced by acid and alkaline conditions).

9.4.5.2 Water bleed

The combined water effluent for the total plant can be minimised by similar techniques to those described above. Again, the stream can be directly treated in a biotreater.

9.4.6 Wastes

9.4.6.1 Spent catalyst

The catalyst in the EO reactors gradually loses its activity and selectivity and is periodically replaced. Spent EO catalyst basically consists of finely distributed metallic silver on a solid carrier (e.g. alumina). Consumption very much depends on the type of catalyst used (high activity versus high selectivity) and local economics (e.g. ethylene price).

Conceptually, the consumption of EO catalyst (in terms of t/t EO produced) could be minimised by running the catalyst for a longer time before replacement with a fresh batch. However, an ageing catalyst gradually loses its selectivity and eventually continued catalyst operation is not justified. The loss in selectivity also involves an increase in carbon dioxide production, which is another environmental factor against prolonged catalyst operation. Reduced catalyst consumption is expected to continue as catalyst development work brings advances in catalyst deactivation rate and hence catalyst lifetime. Spent EO catalyst is sent to an external reclaimer for recovery of the valuable silver. After silver reclamation, the inert carrier requires disposal.

9.4.6.2 Heavy glycol liquid residues

Co-products in the MEG manufacturing process are, in decreasing amounts, di ethylene glycol (DEG), tri ethylene glycol (TEG) and heavier glycols. The individual glycol products are recovered by subsequent fractionation. The bottom stream of the last column of the glycol distillation unit contains the higher boiling ethylene glycols (heavy glycols). The composition of this stream depends on the extent of separating the lower boiling glycol products. Typical compounds are tri ethylene glycol, tetra ethylene glycol and higher ethylene glycols.

The relative amount of heavy glycols formed in the glycol unit can be influenced to some extent by varying the water: EO ratio in the glycol reactor feed. Higher water: EO ratios result in lower co-production of heavier glycols but on the other hand require more energy for the glycol de-watering. The co-products DEG and TEG are usually sold and therefore a reduction of the amount of heavier glycol products is not always desirable. There have been some efforts to suppress the formation of co-products by using a catalyst in the glycol reaction, but this new technology has not yet reached commercial scale.

The stream can be either sold as such, or fractionated to yield pure marketable glycols. BAT is either to sell this stream, or to maximise the recovery of glycols, in order to minimise the volume to be disposed off.

9.4.6.3 Liquid residue from EO recovery section

The concentrated organic fraction obtained after de-watering of the liquid effluent from EO recovery can be distilled, to give valuable glycols and a heavy residue containing salts (either for sale or incineration). The stream can also be sold without distillation.

9.5 Best Available Techniques

As explained in Chapter 6, BAT for a particular LVOC process is determined by considering the three levels of BAT in the following order of precedence: illustrative process BAT (where it exists); LVOC Generic BAT; and finally any relevant Horizontal BAT. The following techniques are BAT for the illustrative process of ethylene oxide / ethylene glycols production.

9.5.1 Process selection

Ethylene oxide process. The direct oxidation of ethylene by pure oxygen is BAT for the production of EO due to the lower ethylene consumption and lower off-gas production. The conversion of an existing air-based unit to pure oxygen feed is a major modification involving a large investment cost and may not be BAT.

Ethylene glycol process. The process is based on the hydrolysis reaction of EO. BAT is to optimise the reaction conditions in order to maximise the production of valuable glycols while reducing the energy (essentially steam) consumption.

9.5.2 Raw material and energy consumption

It is difficult to derive BAT figures for energy consumption in EO/EG plants, as they are very dependent on the capability of the site to supply (or recover) energy, and of the product-mix (EO/EG ratio) of the unit.

The consumption of raw materials and the imports/exports of energy mainly depend on EO catalyst selectivity. Higher catalyst selectivity will result in lower raw material use but also in higher energy imports (or lower energy exports, depending on relative sizes of EO and EG sections of the plant) because less energy can be recovered from the combustion of ethylene. However, the benefits resulting from reduced raw material consumption outweigh the disadvantages of increased energy imports. This means that having the lowest energy import (or largest energy export) may not be BAT.

BAT is to maximise the process selectivity by applying efficient oxidation catalysts and optimising the process parameters within the constraints given by plant design, local site conditions and economics and/or to find commercial outlet for the carbon dioxide product.

BAT is to optimise internal heat integration, between the EO and EG production units, and externally between the EO/EG complex and the surrounding facility.

9.5.3 Plant design

The chemical properties of EO mean that there are various techniques recommended in the industry to prevent the loss of containment and hence occupational exposure to EO. Implementation of these techniques at the same time results in a minimal release of EO to the environment and is also BAT for protecting the environment.

BAT for those vent streams from normal operation that contain organics is connection to a recovery system or to a vent gas treatment (e.g. fuel gas network, flare, scrubber) to achieve an emission of $<5 \text{ mg EO/Nm}^3$. Such a connection would not be appropriate to emergency relief vents that, due to large flow, would overload the pollution control equipment.

In addition to the generic BAT described in Section 6.3, BAT for the prevention of fugitive emissions from EO/EG production is particular consideration of the following components:

- high integrity sealing systems for pumps, compressors and valves
- selection of proper types of O-ring and gasket materials
- number of flanged connections reduced as much as practicable.

BAT for the EO lean absorbing water (EO-free water from the EO stripper bottom) is indirect cooling. In cases where cooling is carried out in open cooling towers, BAT is to reduce the

VOC emission by such means as minimising the organics content of the EO lean absorbing water.

For BAT concerning storage and loading facilities reference is made to Section 6.3. For EO/EG storage and loading special attention shall be paid to designs that:

- avoid any ingress of air or impurities likely to react dangerously with EO
- prevent leaks and prevent soil / water pollution caused by leaks
- a vapour return system on EO truck or railcar loading to minimise the gaseous streams requiring further treatment in, for example, a water scrubber.

9.5.4 Air emissions

Carbon dioxide vent

BAT for the carbon dioxide vent is minimisation of carbon dioxide, methane and ethylene generation by:

- minimisation of the carbon dioxide generation at the reaction step by applying more efficient oxidation catalyst
- removal of methane and ethylene from the fat carbonate solution before routing this solution to the carbon dioxide stripper
- removal of methane and ethylene from the carbon dioxide vent by means of a thermal or catalytic oxidation unit.

Where possible, it is also BAT to recover the carbon dioxide for sale as a product.

Inerts vent

BAT for the inerts vent in the **oxygen process** is transfer to a fuel gas system for energy recovery in, for example, a boiler plant. At facilities where there is an energy excess and there is no outlet for energy re-use, then BAT for the inerts vent may be flaring. Under optimal conditions, fuel gas or flare systems can typically reduce EO emission levels to $< 1 \text{ mg EO/Nm}^3$ (as an hourly average).

BAT for the inerts excess leaving EO recovery in the **air process** is transfer to a second oxidation reactor (to convert where most of the residual ethylene into EO) followed by a second absorber (collecting EO as an aqueous solution) and leaving an inerts vent for release to the atmosphere.

Vent gases containing EO

BAT for EO containing vent gases is:

- for vent streams with a low content in methane and ethylene - water scrubbing with further release of the scrubber overheads to the atmosphere. The BAT-associated emission level (as an hourly average) from scrubbers is $< 5 \text{ mg EO/Nm}^3$.
- for vent streams with a noticeable content in methane and ethylene - water scrubbing with further compression of the scrubber overheads for recycle to the process. Use of the compression and recycle technique (which has no emission to atmosphere) has to be justified on a case by case basis by a cost/benefit analysis
- minimisation techniques such as pressure balancing and vapour return systems in storage and loading.

BAT for the other small vent streams that occur on some plants is direction either to a fuel-gas system or to a common flare system for total destruction of the organics.

BAT for fugitive emissions is concomitant with minimising operator exposure to EO. This is demonstrated by observing threshold limits in ambient air of less than 1 ppm EO (1.8 mg/Nm³) for an 8 hours/day exposure. The measures to minimise fugitive emissions are covered generically in Section 6.3.

9.5.5 Water emissions

BAT is to connect following contaminated water effluent streams to a treatment plant:

- water bleed (whole EO/EG unit)
- water seal flushes from pumps, if not recycled to the process
- cleaning water from maintenance operations.

BAT for reducing the flow and/or the organics contents of the water bleed can be concentration of partial contributor streams with recovery of a heavy organic stream (for sale or incineration).

BAT for the contaminated effluent stream is transfer to a dedicated, central or external waste water biological treatment plant to take advantage of the high biodegradability of the organic contaminants (mainly glycols). The application of BAT allows an emission level of 10 - 15g TOC/t EO ex-reactor to be achieved (assuming an organics destruction rate of 90 %).

9.5.6 By-products and wastes

Ethylene oxide process. BAT to minimise the production of by-products is through optimisation of the oxidation reaction conditions. BAT for the carbon dioxide by-product of the EO production process is minimising formation by the use of more efficient catalysts, or sale, or re-use (after purification) - depending on the local conditions. BAT for the other main by-product (ethylene glycol) is recovery or sale.

BAT for the spent EO catalyst is optimising catalyst life and then recovery of the silver content to leave an inert support for appropriate disposal (e.g. landfill).

Ethylene glycols process. BAT for the heavy glycol by-products is minimising their formation by optimising the hydrolysis conditions (e.g. water excess) or recovery / sale.

9.6 Emerging Technologies

The only emerging technique identified by the information exchange exercise is that the membrane treatment of waste water has been tested [SEPA, 2000 #76].

10 ILLUSTRATIVE PROCESS: FORMALDEHYDE

10.1 General information

Properties. Formaldehyde occurs naturally and is an essential intermediate in mammalian cell metabolism. It is released to the atmosphere as a result of combustion and decomposition of organic materials. Formaldehyde gas is a strong irritant of the eyes, nose and mucous membranes at very low concentrations. Operational practices have therefore been developed to limit the occupational exposure of workers. Formaldehyde is toxic and a suspected carcinogenic at high concentrations, but the strong irritating effect means that human exposure to high concentrations is self-limiting. Formaldehyde poses a moderate fire risk and is explosive in air in the range 7 - 72 %v/v [Ullmann, 1998 #80]. Formaldehyde is soluble in water and most organic solvents.

Uses. Formaldehyde (CH₂O) is an important organic base chemical and is widely used for the manufacture of numerous products; either as 100 % polymers of formaldehyde or a reaction product together with other chemicals. Formaldehyde is used to produce [CEFIC, 2000 #81]:

- a huge variety of resins from the reaction of formaldehyde with phenol, urea, melamine, furfuryl alcohol or resorcinol. Resins products are used as adhesives, bonding agents, glues, paints, coatings, insulators and sealants
- formaldehyde is one of the feedstocks in the production of MDI (methyl diisocyanate) used to produce polyurethanes (for foams, synthetic leather, and engineering plastics)
- polyoxymethylene is a 100 % formaldehyde polymer used as an engineering plastic (e.g. for ski bindings, toothed wheels, kitchen articles)
- water-soluble paints and coatings use formaldehyde polyols
- hydraulic fluids & lubricants based on polyol-esters are used in the aircraft industries
- pharmaceuticals, food and feed use formaldehyde intermediates (e.g. provitamine B3)
- chelating agents such as EDTA and NTA are used in agricultural products, detergents, soaps, cleaners, food industry, mining industry, metal plating, pulp and paper, and textiles.

Production capacity. The total European production capacity for formaldehyde is 3100 kt/yr (Table 10.1). This compares with a production capacity in North America of 2000 kt/yr and 1800 kt/yr in the Far East. In 1998, the EU countries produced 2500 kt (i.e. 83 % of capacity). European production has grown at 3 % per year over the last ten years and is expected to grow by a further 2 % per year over the coming years [CEFIC, 2000 #81].

Country	N° of industrial units	Production capacity (kt/yr as 100 % product)
Austria	1	110 ⁽¹⁾
Belgium	6	160
Denmark	1	40
Finland	2	60
France	5	140
Greece	1	< 10
Netherlands	6	325
Germany	11	1030
Italy	14	510
Portugal	3	50
Spain	7	240
Sweden	3	150
UK	8	200
Total EU	68	3020
Norway	2	70
Switzerland	1	< 10
Total Western Europe	71	3100

1. Austria reports that the plant now has an annual capacity of 91 kilo tonnes.

Table 10.1: European formaldehyde production capacity
[CEFIC, 2000 #81]

Economics. Formaldehyde manufacturing costs depend on the size and location of the plant and whether the plant is integrated into a chemical manufacturing complex. Investment costs depend on the plant size and the choice of technology. Energy costs are usually low as the exothermic process produces export steam and there is only the cost of electricity consumption. The cost of formaldehyde production is dominated by the price of methanol feedstock and so the prices of the two chemicals are closely linked. Methanol prices are driven by demand factors, such as MTBE consumption in gasoline, and international supply capability. In 1995, a global imbalance between supply and demand caused European prices of methanol to surge (Table 10.2). Methanol prices do not necessarily follow the petrochemical business cycle, so formaldehyde process economics show some decoupling from the petrochemical industry.

	1990	1991	1992	1993	1994	1995	1996	1997	1998
Quarter 1	210	290	225	200	285	815	225	288	330
Quarter 2	210	350	215	190	320	270	225	344	250
Quarter 3	210	285	170	190	440	250	225	330	205
Quarter 4	235	240	170	220	675	225	247	330	195
Average	216	291	195	200	430	390	231	323	245

Table 10.2: Methanol contract prices in north-west Europe (DM/t)

Source Platts in [CEFIC, 2000 #81]

It has been estimated [Environment Agency (E&W), 1998 #1] that, in 1997, a typical West European plant producing 50 kt/yr of 37 % formaldehyde had a capital cost of £11M. With variable costs of £38/tonne (the cost of methanol, minus a small credit for steam) and fixed costs of £20/tonne, the cash cost of production was around £60 per tonne. A typical cash cost margin on formaldehyde is around £20 - 35 per tonne (of 37 % solution). Much of the formaldehyde consumption is in integrated downstream units or on long-term contracts, so transfer prices depend upon negotiation in each circumstance. Large-scale purchasers of formaldehyde often agree a price formula that includes the price of methanol.

CEFIC have estimated [CEFIC, 2000 #81] that if a medium sized formaldehyde plant directly employs 10 - 20 people, then the 70 European plants account for 1000 employees. To this must be added the indirect manpower needed for administration, maintenance and technical support.

10.2 Applied processes and techniques

Historically, propane, butane, ethylene, propylene, butylene and ethers have all been used as starting materials for formaldehyde manufacture but none are used today [Wells, 1991 #60]. Today, formaldehyde is produced from methanol, either by catalytic oxidation under air deficiency ('silver process') or air excess ('oxide process'). There are further options to design the silver process for either total or partial methanol conversion. European formaldehyde production capacity is split roughly equally between the silver and oxide routes.

Methanol is the main raw material for both process routes and is either produced on-site or imported (by ship, barge, rail or road tank). Because of its flammability methanol, is stored in tanks at atmospheric pressure under air or nitrogen. The only other auxiliary raw materials are:

- air used to oxidise the methanol (in both processes)
- demineralised process water to absorb formaldehyde (this leaves with the commercial product) and to generate steam
- optionally, very small quantities of sodium hydroxide are injected in the absorption step of the oxide process and leave with the commercial product.

Formaldehyde is offered commercially as 37 – 50 % aqueous solutions ('formalin'). The various concentrations of formaldehyde product are stored in tanks under atmospheric pressure.

10.2.1 Silver process (with total methanol conversion)

The silver process is an oxidative dehydrogenation of methanol with air over a crystalline silver catalyst. In the initial step, methanol is dehydrogenated (Equation 1) and there is a secondary combustion of hydrogen (Equation 2) resulting in the overall reaction shown in Equation 3.



The process for total methanol conversion consists of four main unit operations, namely: methanol vaporisation, catalytic methanol conversion to formaldehyde, formaldehyde absorption and emission control (as shown in Figure 10.1).

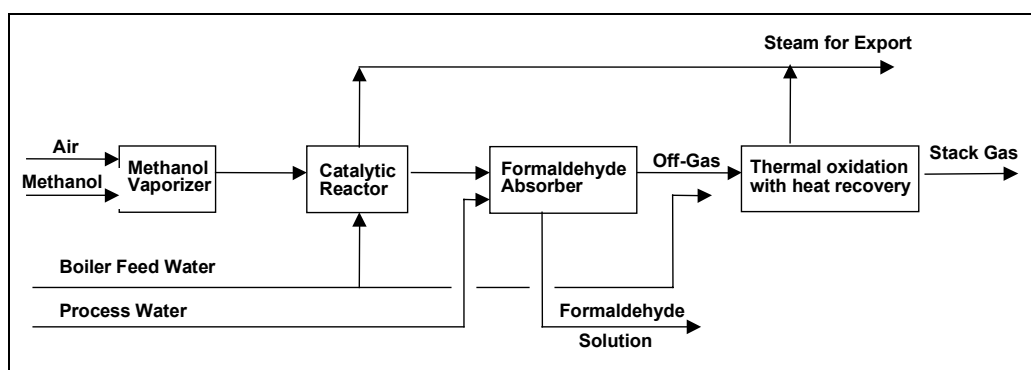

Figure 10.1: Schematic of silver process
[CEFIC, 2000 #82]

10.2.1.1 Methanol vaporisation

Methanol is fed into the bottom of a vaporiser column and diluted by a methanol/water mixture. The methanol/water mixture is heated and passes to the top of the vaporiser column together with water from the scrubber on top of the absorption column. The heat required to evaporate the methanol/water mixture is provided by heat exchangers that are linked to the absorption and catalytic conversion system. Overall the feed to the vaporiser column is about 40 % water and 60 % methanol.

Fresh process air enters the bottom of the vaporiser column and passes counter-current to the descending liquid methanol/water mixture. A gaseous mixture of methanol in air is formed by the actions of stripping and vaporisation. The methanol-rich gas mixture contains enough methanol, nitrogen and water to be safely above the upper explosion limit. After passing through a de-mister, the gaseous mixture is superheated with steam in order to avoid any partial condensation above the silver catalyst bed.

10.2.1.2 Catalytic methanol conversion

The catalytic reactor contains a silver catalyst bed with layers of silver crystals of a defined range of particle sizes supported on a perforated tray. The catalyst lifetime, typically 3 to 9 months, is influenced by a number of operating conditions. Depleted catalyst can be completely recycled. Immediately below the catalyst bed is a water boiler that produces steam and

simultaneously cools the hot reaction gases to a temperature corresponding to that of the pressurised steam. An additional gas cooler rapidly reduces the reaction gas temperature to about 85 °C.

In order to minimise the over-oxidation of methanol and the decomposition of formaldehyde to carbon monoxide, carbon dioxide and hydrogen, the residence time is very short (<0.1 seconds). The reaction occurs at slightly elevated pressure and temperatures of 650–700 °C. Water is injected to regulate the reaction temperature and extend catalyst life. Plants producing higher concentrations of formaldehyde cannot inject water to regulate temperature because of dilution of the final product and the temperature is instead controlled by the air/methanol ratio. Traces of methyl formate and formic acid are also formed but the side-reactions are minimised by the use of rapid cooling. The process is operated above the upper explosion limit (in contrast to the oxide process). The yield of formaldehyde is within the range 87 to 90 mol% and is highly temperature dependent. Methanol conversion and formaldehyde selectivity are optimised by the careful selection and control of temperature, catalyst, methanol/oxygen ratio, water addition and reaction gas quenching.

10.2.1.3 Formaldehyde absorption

The cooled reaction gas enters a multi-stage packed absorption column and is contacted counter-current with aqueous formaldehyde solutions whose concentrations decrease from stage to stage. The excess heat from the first absorption circuit is often used to preheat the methanol/water feed in the methanol evaporation column in a recuperative heat exchanger. In the final absorption stage, the gas is scrubbed counter-current with de-mineralised water. The concentration in the first absorption stage can be controlled at a concentration of 40 – 60 % w/w formaldehyde as required by the final product specification. The product formaldehyde contains up to 1.5 %w/w methanol and this acts as a stabiliser to prevent polymerisation.

10.2.1.4 Emission control

The reaction off-gas contains about 18 – 23 % hydrogen and has a calorific value that makes it suitable for thermal incineration with energy recovery, either in a dedicated thermal oxidiser, a gas engine (with the production of electricity) or a conventional boiler (see 10.4.5.1).

10.2.2 Silver process (with partial methanol conversion)

The silver process may also be operated to give partial (about 80 %) methanol conversion using methanol with only small amounts of water (Figure 10.2). The reaction over the silver catalyst takes place at the slightly lower temperature of 590 - 650 °C but again with methanol significantly above the upper explosion limit. The main difference is that the process solution from the absorber contains excess methanol and is fed to a vacuum distillation column where methanol is separated off and recycled to the vaporiser. At the bottom of the distillation column a product is obtained with about 62 % formaldehyde and up to 1.5 % methanol. The off-gas from the process is combusted to generate steam (about 1.5 t steam / t formaldehyde) either in a dedicated incinerator or in a power plant.

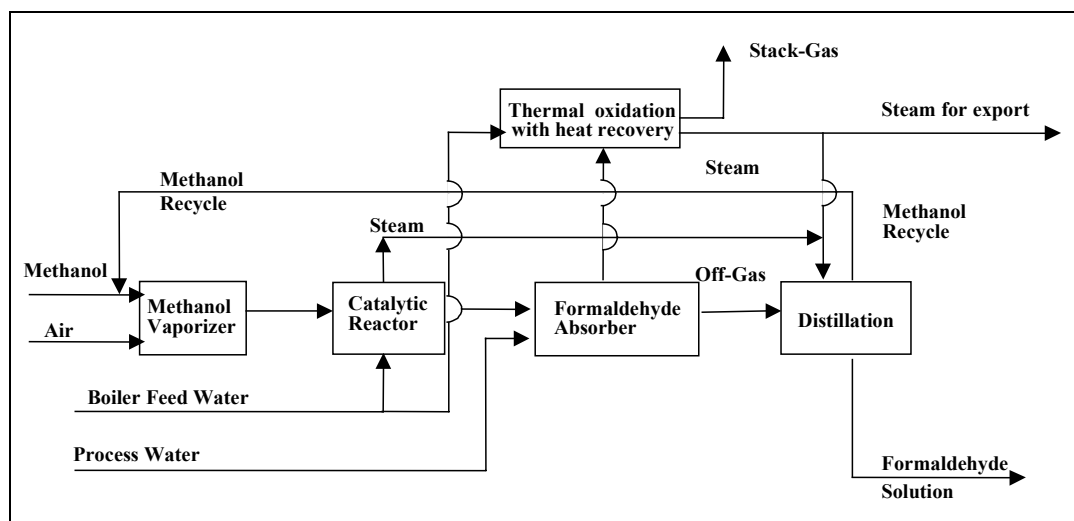
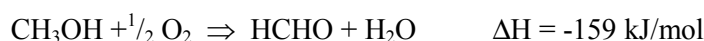

Figure 10.2: Schematic of partial methanol conversion in the silver process [CEFIC, 2000 #82]

10.2.3 Oxide process

In the oxide ('Formox') process the formation of formaldehyde is accomplished by the direct oxidation of methanol with excess air over a metal oxide catalyst according to the formula:



The process gives a high yield of formaldehyde on a single pass, and also a methanol conversion above 99 mol%, making the recovery of methanol from the final product unnecessary. The actual formaldehyde yield is in the range of 91 - 94 mol% of the theoretical. The process can be divided into four unit operations (as shown in Figure 10.3): methanol vaporisation, catalytic conversion of methanol to formaldehyde, formaldehyde absorption, and catalytic incineration of emissions.

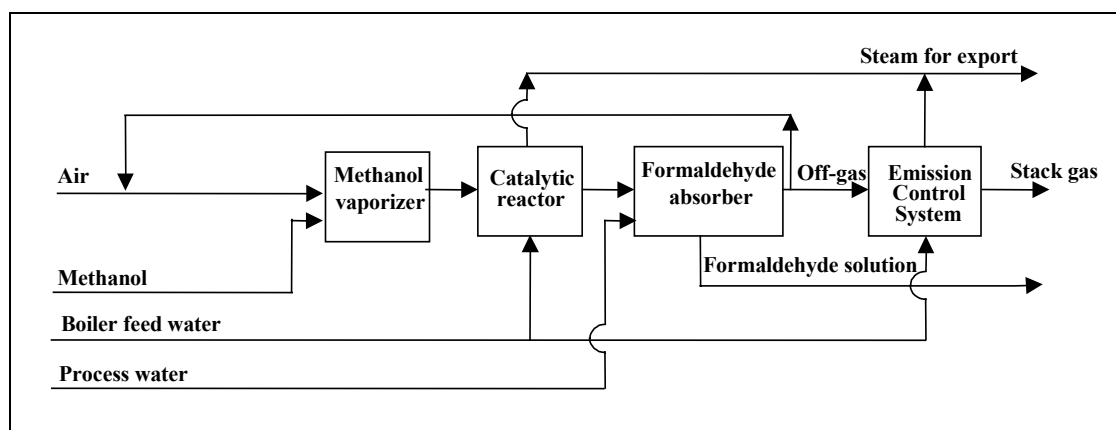

Figure 10.3: Schematic of oxide process [CEFIC, 2000 #82]

10.2.3.1 Methanol vaporisation

Fresh air is mixed with recycled gas from the absorption tower and fed to the vaporiser / pre-heater. Pure methanol is flash-vaporised into the gas stream, most often using heat generated in

the process. The methanol-to-air ratio is controlled to maintain a safe and accurate feed of the desired oxidation atmosphere. A high content of methanol is possible, as the recycle gas is high in nitrogen, thereby ensuring an atmosphere with excess air and below the lower explosion limit (in contrast to the silver process which is operated above the upper explosion limit).

10.2.3.2 Catalytic conversion of methanol to formaldehyde

The methanol oxidation is an exothermic reaction that takes place over a solid oxide catalyst at atmospheric pressure and 300 - 400 °C. The catalyst is an intimate mixture of ferric molybdate and molybdenum trioxide, but performance may be enhanced by small amounts of other metal oxides. Chromium oxide promoters are no longer used in Europe for catalyst enhancement because of the carcinogenic nature. The catalyst is simultaneously regenerated with atmospheric oxygen and has a typical lifetime of 10 - 18 months.

The gas mixture entering the reactor tubes is preheated by heat transfer fluid (HTF). The HTF system may be molten salt or a boiling HTF (in which case the system functions as a thermosiphon through the reactor shell / steam generator and there is no need for forced circulation).

As the gas reaches the catalyst, the reaction starts and heat is evolved. The reaction by-products are very small amounts of dimethyl ether, carbon monoxide, and formic acid. To promote good heat transfer, the upper part (and sometimes the lower part) of the tubes are loaded with inert rings. HTF fills the reactor shell and removes the heat of reaction. Before the reaction gas enters the absorption tower, the gas is heat exchanged to reduce the inlet gas temperature to the absorber and to produce steam.

10.2.3.3 Formaldehyde absorption

The cooled reaction gas enters the bottom of an absorption tower that consists of several different sections to obtain maximum absorption efficiency. Process water is fed to the top of the absorber and flows counter-current to the gas flow at a rate that depends on the desired formaldehyde concentration of the final product. The heat of absorption is removed by both internal and external cooling. Part of the heat is utilised in the process in order to optimise the energy utilisation in the plant.

Dependent on application, formaldehyde solutions of 37 – 60 % w/w are produced. As the conversion of methanol is highly efficient, the levels of methanol in formaldehyde product can be as low as 0.2 - 0.3 %w/w. As with all formaldehyde processes, the methanol content can be further reduced by distillation (with the methanol being recycled to the reactor).

The off-gas from the absorber contains traces of un-reacted methanol, carbon monoxide, dimethyl ether and formaldehyde. Part of the off-gas stream is recycled to the process and the rest is sent to a catalytic incinerator.

10.2.3.4 Catalytic incineration of emissions

The absorber exhaust gas is not directly combustible in an incinerator as the oxide process is a full oxidation reaction and the waste gases have a low concentration of organics. The exhaust gas is therefore oxidised over a catalytic bed of noble-metal catalyst. The exothermic reaction can produce steam in an integrated steam generator and also preheats the absorber off-gas before it enters the incinerator (see 10.4.5.1). The profitability of producing steam is checked on a case-by-case basis.

10.3 Consumption and emission levels

10.3.1 Raw materials and energy

All the formaldehyde process routes are net producers of steam due to the exothermic reaction. There is a strong link between the consumption of methanol and the rate of steam production. The main losses of methanol are from over-oxidation reactions (that produce carbon monoxide and carbon dioxide) but these reactions are far more exothermic than the reaction producing formaldehyde. Therefore, when more methanol is combusted to carbon monoxide and/or carbon dioxide, more heat is generated and more steam is produced, but the methanol yield is lower [CEFIC, 2000 #87]. This trade-off is shown in Table 10.3 for the production of 1 tonne of 100 % formaldehyde by different routes.

	Silver process-Total methanol conversion	Silver process - Partial methanol conversion	Oxide process
Methanol yield (%)	87 - 90	87 - 90	91 - 94
Methanol consumption (kg / tonne of 100 % formaldehyde)	1185 - 1226	1185 - 1226	1135 - 1170
Net steam export (tonnes / tonne of 100 % formaldehyde)	2.6 ⁽¹⁾	0.4	2.0
Electricity consumption (inc. off-gas combustion) (kWh / tonne of 100 % formaldehyde)	100	100	200 - 225

Note 1: Roughly 45 % of this figure is due to off-gas combustion

Table 10.3: Trade-off between yield, steam export and electricity consumption [CEFIC, 2000 #87]

The silver process typically consumes more methanol than the oxide process. The significance of this difference will depend on the methanol price and is partly off-set by the higher rate of steam production. In terms of energy use, the silver process has moderate electricity consumption, because the process operates close to atmospheric pressure and the smaller gas volumes allow the use of smaller blowers. Electricity consumption in the oxide process is higher because the process gas is methanol lean and the air content of the circulating gas is higher which results in higher gas volumes.

10.3.2 Air emissions

In the **silver process** the primary source of formaldehyde process emissions is the purging of gases from the secondary absorber. The product fractionator (distillation column) is another possible formaldehyde emission source, but most producers feed the fractionator gases to the absorber before venting. Formaldehyde emissions also occur during plant start-up, but start-up events are minimised because formaldehyde plants are normally continuously operated at design conditions to achieve highest yields. This reduces the shut-down / start-up costs and minimises the formic acid concentration in formaldehyde storage tanks. Various start-up procedures are used, but the reaction gases are routed to the absorption column. The reactor feed rate varies as the start-up proceeds. Initially, the reactor produces mainly CO and water vapour, but as the temperature rises, the formaldehyde yield increases, increasing the amount of formaldehyde in the vent-gas [Rentz, 1999 #114].

The **oxide process** operates below the explosive limit of methanol with an excess of air resulting in stable reactor conditions during start-up and so venting is not required and there are no intermittent start-up emissions. Formaldehyde process emissions result from venting gases from the product absorber. The emission composition and flow rates are affected by the percentage of absorber gas recycled. By recycling a portion of the oxygen-lean vent gas, the

oxygen concentration in the reactor feed mixture can be reduced, making it possible for the concentration of methanol to be increased without forming an explosive mixture. This reduces the volume of reaction gases and thus reduces the emission rate of formaldehyde from the absorber [Rentz, 1999 #114].

For both the silver and oxide processes, the off-gas from the formaldehyde absorption column is the only continuous waste gas stream. Its composition before and after treatment (thermal or catalytic incineration) is given in Table 10.4.

		Silver process	Oxide process
Before Treatment	Gas volume (Nm ³ /t 100 % formaldehyde)	1500 - 1700	2300 - 2400
	Nitrogen & argon (% v/v)	65 - 75	91 - 93 %
	Hydrogen (% v/v)	18 - 23	-
	Oxygen (% v/v),	-	5 - 7
	Carbon dioxide (% v/v)	4	-
	Formaldehyde	0.04 - 1.6 kg/t formaldehyde	150 - 700 mg/Nm ³ (9 % of all VOCs)
	Methanol (kg/t formaldehyde)	6 - 8	500 - 2000 (18 % of all VOCs)
	Carbon monoxide	10 - 14 kg/t formaldehyde	10 - 20000 ⁽¹⁾ mg/Nm ³
	Dimethyl ether (DME)		6 - 10000 (73 % of all VOCs)
	Other components	Water, methyl formate	Carbon dioxide
After Treatment (2)	Gas volume (Nm ³ dry basis/t 100 % formaldehyde)	2200	2300 - 2400
	CO (mg/Nm ³)	50 - 150	20 - 50
	CO (kg / tonne 100 % formaldehyde)	0.1 - 0.3	0.05 to 0.1
	NOx (as NO ₂)	150 - 200 mg /Nm ³ 0.3 - 0.45 kg per tonne 100 % formaldehyde	Virtually none (max. 50 mg/m ³)
	Formaldehyde		0.0004 kg/t product. 0.15 mg/m ³ (TA Luft limit value is <5 mg/Nm ³)
	Dimethyl ether (DME)		<50 mg/Nm ³
	Methanol		<15 mg/Nm ³
	VOC as total carbon		0.6 mg/m ³ 0.0016 kg/t product
	Dust		0.2 mg/m ³ , 0.0005 kg/t
General: CEFIC data does not quote reference conditions for gas concentrations but assumed to be on a dry basis at normal temperature and pressure. Sampling intervals and oxygen concentration after oxidation are unknown.			
(1) High CO content may be an indication of catalyst poisoning. Although the figure is extreme, the emission control system (e.g. incinerator) may have to handle it.			
(2) Treatment is thermally in the case of the Silver process and catalytically in the case of the Oxide process.			

Table 10.4: Waste air streams before and after treatment

[CEFIC, 2000 #87] [EC VOC Task Force, 1990 #116] [Environment Agency (E&W), 1998 #1] [UBA (Germany), 2000 #91]

Further emissions may arise from storage breathing and fugitives. Emission data is given in Table 10.5 and for Dutch and Swedish formaldehyde plants in Table 10.6 and Table 10.7.

	Emission factor from storage vents (g/t product)	
	Prior to treatment	After treatment
Storage – silver process	30	3 (with scrubber) 0.6 (with thermal oxidation)
Storage –oxide process	30	3 (with scrubber)
Handling – both processes	10	0.4 (vapour recovery)

Table 10.5: VOC emissions from formaldehyde storage and handling
[Rentz, 1999 #114]

	Source	Type	Emission factor (kg/tonne of product)		Concentration (mg/Nm ³)	
Silver Process	Thermal incinerator	Point (combustion)	CO ₂	108		
			CO	0.070		
			NO _x	0.043 ⁽³⁾		
	Storage, loading / unloading	Point	CH ₂ O	0 or 0.007		
	Various sources (flanges, pumps)	Fugitives of formaldehyde, methanol, hot oil ⁽²⁾	CH ₂ O	0.25		
			MeOH	0.31		
Oxide Process	Catalytic incinerator	Point (combustion)	CH ₂ O	0.0028	CH ₂ O	3.2
			MeOH	0.0017	MeOH	2.0
			DME	0.0022	DME	2.5
	Various sources, (flanges, pumps)	Fugitive emissions of formaldehyde, methanol, hot oil ^(1,2)	CH ₂ O	0.0006		
			MeOH	0.0007		
		DME	2 x 10 ⁻⁶			
		hot oil	4 x 10 ⁻⁶			

(1) Fugitive emissions are measured based on emission factors and now show much lower levels (3 to 80 times). The calculation of fugitive emissions by emission factors gives rather exaggerated results.

(2) Fugitive emissions are relatively independent of throughput so figures expressed in kg per tonne production have little significance. The figures given are based on 100 kt/yr capacity.

(3) NO_x emission is much lower than the CEFIC data, probably due to low combustion temperatures in the thermal incinerator.

Table 10.6: Air emissions from Dutch formaldehyde plants
[InfoMil, 2000 #83]

Variable	Emission in 1998 (tonnes)	Specific emission (kg/tonne feedstock) *
VOC	11	0.11
CO	25	0.25
TOC	7.7	0.08

* Based on methanol consumption of 101000 tonnes

Table 10.7: Emissions from a Swedish formaldehyde plant in 1998
[SEPA, 2000 #76]

The lean gas from an Austrian formaldehyde plant (silver process) has a calorific value of approximately 2000 kJ/m³. Approximately 2/3 of the produced lean gas is used for the production of electricity in gas engines. The rest is used for steam production in two steam boilers.

The combustion of the lean gas in the gas engines produces electrical energy (2.352 kW at an electrical efficiency 34 %). The exhaust gas of these gas engines is led to catalytic converters to oxidise the CO of the exhaust gas. Steam boilers use the waste heat of the gas engines exhaust to produce 1300 kg/h steam at 10 bar (855 kW). Further energy is recovered by preheating the boiler feed water with the cooling water of the gas engines (12 000 kg/h, Δ T = 60 °C, 835 kW). The remaining energy is lost via the mixture cooler, oil- and water cooler and by radiation of the engines. The overall energy utilisation is 57 – 67 % and the heat utilisation is 23 – 33 %. Due to the low combustion temperatures the formation of NO_x is low. The amount of CO and un-

burnt H₂ in the exhaust gases is reduced due to the use of catalytic converters. The emission limits and the actual emissions of the gas engines can be found in line 2 of Table 10.8. The costs for the power plant, the steam storage tank and the additional waste heat boiler have been approximately 3.63 million Euro.

The rest of the lean gas (approximately 1/3), which is not used for electricity production in the gas engines is used for steam production in two flame tube boilers. The emission limits and the current emission levels of these two steam boilers are also presented in Table 10.8 (line 3 and 4). The influence of the use natural gas as additional fuel in the steam boilers can also be seen in this Table. Natural gas addition produces higher NO_x but lower CO emissions (see line 3 of Table 10.8) [Austria UBA, 1999 #64].

Source	CO		NO _x		Total carbon		Dust	
	Limit	Actual	Limit	Actual	Limit	Actual	Limit	Actual
Gas engine ⁽¹⁾	150	55	100	12	-	10		
Steam boiler 3 ⁽²⁾⁽³⁾	100	<2	200	21	20	<2	10	<2
Steam boiler 2 ⁽²⁾⁽⁴⁾	100	79	200	4	20	<2	10	

All values as ½ hour mean values in mg/m³
 Note 1: Oxygen content 5 Vol%, dry exhaust gas at normal state (0 °C and 1013 mbar)
 Note 2: Oxygen content 3 Vol%, dry exhaust gas at normal state (0 °C, 1013 mbar)
 Note 3: On feed of natural gas (126 - 128 m³/h) and lean-gas (4578 - 4825 m³/h). Boiler 3 built in 1998.
 Note 4: On feed of natural gas (1 - 2 m³/h) and lean-gas (2800 - 3600 m³/h). Boiler 2 built in 1962.

Table 10.8: Air emissions from gas engines and steam boilers on an Austrian formaldehyde plant [Austria UBA, 1999 #64]

Table 10.9 gives a summary of emission factors (derived from a literature search) for formaldehyde plants and demonstrates the impact of some techniques.

	NM VOC (g/t product)	VOC (g/t product)
Oxide process		
Absorber – prior to treatment	470	
Absorber – thermal oxidation	0.9	
Fugitives - uncontrolled	470 g/h	
Fugitives – quarterly I/M of pumps and valves	220 g/h	
Fugitives – monthly I/M of pumps and valves	130 g/h	
Fugitives – monthly I/M of pumps and valves and use of mechanical seal pumps and rupture disks	63 g/h	
Start-up		0
Overall	3000 - 5000	8000
Silver process		
Absorber – prior to treatment	380	
Absorber – thermal incinerator	7.6	
Absorber – flare	76	
Product fractionator - uncontrolled	330	50
Product fractionator - recycling to absorber	0	
Product fractionator - water scrubber	17	
Fugitives – uncontrolled	700 g/h	
Fugitives – quarterly I/M of pumps and valves	300 g/h	
Fugitives – monthly I/M of pumps and valves	220 g/h	
Fugitives – monthly I/M of pumps and valves and use of mechanical seal pumps and rupture disks	63 g/h	
Start-up	100	100
Overall	3000 - 5000	6500
Note: The fugitive emissions will depend not only on the Inspection and Maintenance (I/M) routine, but also factors such as the plant status, the quality of the equipment used, the products handled, and the efficiency of the leak repair.		

Table 10.9: Review of air emission factors for formaldehyde plants [Rentz, 1999 #114]

10.3.3 Water emissions

Under routine operating conditions, the silver and oxide processes do not produce any significant continuous liquid waste streams. Effluents may arise from spills, vessel wash-water and contaminated condensate (boiler purges and cooling water blowdown that are contaminated by upset conditions such as equipment failure). Many of these streams can be reworked into the process to dilute the formaldehyde product.

A German oxide plant is reported [UBA (Germany), 2000 #91] to have untreated effluent with a COD of 8720 mg/l (0.5 kg COD/tonne product). Biological treatment reduces the COD to 100 mg/l, (0.008 kg COD/tonne product) in a waste water volume of 0.07 m³/tonne product.

10.3.4 Wastes

There is negligible formation of solid wastes in the silver and oxide processes under normal operating conditions. Almost all of the spent catalyst from reactors and off-gas oxidation can be regenerated and as a result there are minimal catalyst wastes for disposal. A small build-up of solid para-formaldehyde may occur (principally at cold spots in equipment and pipes) and is removed during maintenance activities. Filters may also be used in the purification of formaldehyde product and this generates spent. In the oxide process the heat transfer fluid is periodically checked and in rare cases changed. Spent fluid is most frequently sent to a reclaimer (for recycling) or incineration.

Waste arisings from Dutch and German formaldehyde plants are given in Table 10.10.

Source	Destination	Emission factor (kg/tonne product)	
		The Netherlands	Germany
Reactor catalyst (Silver)	Recycling	0.04 – 0.1	
Reactor catalyst (Fe/Mo Oxide on carrier)	Recycling	0.06	0.01
Catalyst from off-gas incinerator (Pt on carrier)	Recycling	0.002 ⁽¹⁾	
Oil/ filters	Disposal	0.06	0.5082
Domestic, sewer sludge	Disposal	-	

(1) CEFIC give a figure of 0.015 kg/t 100 %, with the spent platinum catalyst being recycled.

Table 10.10: Waste arisings from Dutch and German formaldehyde plants
[InfoMil, 2000 #83] [UBA (Germany), 2000 #91]

10.4 Techniques to consider in the determination of BAT

10.4.1 Process route

The selection of process will depend on a variety of local factors such as: methanol consumption and price; plant production capacity; physical plant size; electricity use; steam production; and catalyst price / life. Table 10.11 provides a simplified comparison of some of the main differences between the silver and oxide processes.

Factor	Silver process	Oxide process
Raw material		Less methanol used (as total conversion of methanol)
Products	Formaldehyde product contains more methanol but little or no sodium hydroxide	Formaldehyde product usually contains small amounts of sodium hydroxide, but less methanol
Energy	Steam produced and lower electricity consumption ⁽¹⁾	Less steam produced and more electricity used
Yield	87 – 90 %	91 – 94 % Low reaction temperature so high selectivity
Reaction conditions		Lower temperature Large air excess so larger equipment and more waste gas
Others	Physically smaller plant	Off gas is not auto-thermally combustible
(1) There are plants with zero external electricity consumption as a result of maximising internal production [Austria UBA, 1999 #64]		

Table 10.11: Comparison of the silver and oxide processes

The silver process (with total conversion) and the oxide process both have advantages and disadvantages. There are no reported examples of existing units being converted from the silver to the oxide route (or *vice versa*) so it is important to select the most appropriate route from the start. The process choice is therefore decided by the importance of the above factors in the local context.

Even the silver process (with partial conversion), which initially gives the impression of having limited application because of its lower conversion rate, is a valued route where high concentration formaldehyde solutions (above 60 %) are required (e.g. for use on-site in downstream product manufacture). In these cases the lower steam output (due to the heat needed to separate and recycle the methanol) is an acceptable price to pay.

When the requirement is for a low methanol content in the formaldehyde solution (below 0.5 % by weight) then the oxide process and silver process with partial methanol conversion will be preferred. A low methanol content can also be achieved with the silver process (total conversion route) if additional equipment is provided.

10.4.2 Equipment design

Wall effects in the reactor can be responsible for poor product selectivity and are an important part of reactor design. If the throughput and reaction temperature have been optimised, then the formaldehyde production capacity increases in proportion to the reactor diameter. The largest known reactor (BASF in Germany) has a diameter of 3.2 metres and a production capacity of 72 kt/yr (as 100 % formaldehyde) [Ullmann, 1998 #80].

Flanges can be a significant source of fugitive losses and to minimise losses a European plant has installed a 50m, one-piece (i.e. flange-less) absorption column that reduces maintenance and fugitive losses (Source: CEFIC Sub-group meeting 26/01/00).

Process equipment is designed to operate either above or below the explosive range but is also protected with relief devices such as bursting discs and pressure relief valves. These devices require periodic inspection and replacement.

Formaldehyde solutions corrode carbon steel and so all exposed equipment must be made of corrosion resistant alloy (e.g. stainless steel). Pipes that convey water or gases must be made of alloys that do not cause metal poisoning of the silver catalyst [Ullmann, 1998 #80].

10.4.3 Raw materials consumption

Process losses of methanol and/or formaldehyde occur through miscellaneous vents to air, water flushing of the process unit; and incidental spillages, but the main losses are due to the reaction selectivity. The selectivity of the formaldehyde production reaction depends on closely interrelated factors such as:

- catalyst: nature, age, activity/selectivity
- operating conditions: temperature, gas flow rate and composition
- reaction equipment: heat transfer capabilities, mechanical design.

As changing a catalyst requests a total reactor shutdown lasting 12 hours (every 3 to 9 months) for the silver process and 3 - 4 days (every 10 to 18 months) for the oxide process, this operation is carried out on a scheduled basis. Significant improvements have been made to the selectivity, activity, lifetime and structural stability of catalysts through research and development. In general, good catalysts provide improved yield, improved production capacity and product quality, have a reasonable lifetime and have a good price-to-performance ratio.

10.4.4 Utilities consumption

Electricity and steam are the two main utilities in formaldehyde production and their consumption is directly linked to process selectivity. The process selectivity is, in turn, a function of the carbon loss (as carbon monoxide and carbon dioxide) in the reactors. The lower the carbon loss, the higher the selectivity (i.e. less methanol is needed to produce each tonne of formaldehyde). However, the full oxidation of carbon is very exothermic (compared to the reactions producing formaldehyde) so high carbon loss produces more steam. A poor catalyst therefore produces large quantities of steam but is detrimental to methanol consumption.

As all formaldehyde units produce more steam than they consume it is important that there is efficient energy management at an overall site level. As long as the industrial site is able to consume the excess steam delivered by the formaldehyde unit, then the steam excess can be maximised through heat recovery techniques the hot process streams.

The major electricity consumer of a formaldehyde unit is the process air blower. The usual ways to reduce the energy consumption of blowers are applied; i.e. choice and efficient design of the blower, reduction of pressure drops (particularly over the catalytic bed) and recycle of the process gas (in the particular case of the oxide process).

The energy efficiency of formaldehyde production can also be improved by using the lean gas to produce electricity in gas engines and steam in steam boilers. A fuller description of this technique is given in Section 10.3.2 and in [Austria UBA, 1999 #64].

10.4.5 Air emissions

10.4.5.1 Reaction off-gas

Once formaldehyde has been absorbed from the reaction gas, a wet off-gas remains containing small amounts of VOC (methanol, formaldehyde). Further components are typically carbon monoxide, carbon dioxide, nitrogen and oxygen in the case of the oxide process, or carbon dioxide, carbon monoxide, nitrogen and hydrogen in the case of the silver process. The off-gas is combusted to prevent emissions to air and to recover the calorific value, but the type of combustion depends on its heating value.

In the **silver process** the off-gas has high heating value (typically 2200 kJ/Nm³ or 4700 MJ/t 100 % formaldehyde) because it contains excess hydrogen. This is due to the fact that the silver process operates under air deficit and this leads to free hydrogen resulting from the methanol dehydrogenation reaction. The off-gas is therefore amenable to thermal combustion. The combustion can be in a dedicated thermal oxidiser with steam production or in a central boiler plant. The emission performance of a dedicated thermal oxidiser is given in Table 10.4. Thermal incineration has an estimated efficiency of 99.8 % [InfoMil, 2000 #83]. The stack exhaust gas contains nitrogen, water, carbon dioxide, carbon monoxide and nitrogen oxides.

In the **oxide process**, the off-gas has a low heating value (typically 500 kJ/Nm³ or 1100 MJ/t 100 % formaldehyde). Off gas from the oxide process can be burnt in an existing central boiler plant but this tends to reduce the steam production capacity. More efficient combustion is provided by catalytic oxidation. Catalytic oxidisers have typical operating temperatures of 300 - 500 °C and a conversion efficiency to carbon dioxide and H₂O of 99.7- 99.8 %. Typical Pd/Pt wire catalysts on a Al₂O₃ support have a 4 - 6 year lifetime. Running costs are very low as manpower and maintenance are usually accounted for on the formaldehyde plant.

Steam production from catalytic oxidisers is small and the feasibility of steam raising is determined by local circumstances. But it is estimated that a catalytic unit can produce 5000 tonnes of steam per year and if this is charged out at, a conservative, £6 per tonne, then this yields an income £30000 per year [Environment Agency (E&W), 1998 #1].

The emission performance of a dedicated catalytic oxidiser was given in Table 10.4 and Table 10.6. It is reported [Environment Agency (E&W), 1998 #1] that the German emission limit of 5 mg/Nm³ formaldehyde is just achievable. Other limits are typically 100 mg/Nm³ carbon monoxide and a total of 75 mg/Nm³ for other organic compounds such as DME (dimethyl ether). Compared to thermal oxidation, catalytic oxidation leads to virtually no NO_x and lower CO emissions.

10.4.5.2 Storage tanks

The storage tanks for methanol raw material and the various concentrations of aqueous formaldehyde product have emissions from breathing and from loading/unloading activities. The methanol storage vents are treated by thermal or catalytic oxidation over a noble metal, adsorption on activated carbon, or connection to the suction of the process air blower. The formaldehyde storage vents are treated by thermal or catalytic oxidation, absorption in water or connection to the suction of the process air blower.

An appropriate formaldehyde storage temperature must be maintained as low temperatures (and/or concentration increase) cause the precipitation of para-formaldehyde, whilst formic acid tends to form at high temperatures. Stabilisers may be added to enhance storage but they should not interfere with further processing. Stabilisers are selected to be compatible with end-user requirements and examples are lower alcohols, urea and melamine [Ullmann, 1998 #80].

In general terms, the size of storage tanks should be minimised but cognisance should be taken of the dynamics between the supply of methanol and use of formaldehyde so that interruptions to the continuous process are minimised. Storage capacity should consider the rate of usage of downstream processes and recognised downtime for maintenance. The storage of formaldehyde and methanol may also invoke the requirements of the Seveso Directive.

10.4.5.3 Fugitive emissions

The silver and oxide processes both run close to atmospheric pressure and so there is little pressure gradient to force fugitive emissions. Emissions from maintenance activities are negligible because it is easy to rinse residues from process equipment (both formaldehyde and methanol are water-soluble), but minor emissions do occur for infrequent, short periods (e.g. during filter cleaning). VOC releases mainly consist of methanol and formaldehyde. The strong odour of formaldehyde (detection limit in the range of 1 ppm) warns operators of abnormal situations. For occupational health reasons, extensive measures have been taken by formaldehyde plants to prevent VOC releases (including fugitives) and the typical measures are described in Section 5.3.1.3. Formaldehyde leaks can be detected without a sophisticated monitoring system of on-line analysers because the strong odour.

Formaldehyde solutions with high concentrations solidify when spilled. Vapour emissions from spills are therefore low and the resulting solid material can be easily removed. If vapours do escape from liquid formaldehyde spills then foams can be used to reduce the loss and water can be sprayed over the vapour cloud.

Although it is difficult to predict the exact reductions in fugitive emissions that can be achieved by LDAR, it is reported that a quarterly inspection and maintenance programme (I/M) for pumps and valves has an overall efficiency for formaldehyde emissions of about 57 % (see Table 10.9). Monthly I/M for pumps and valves has an overall efficiency of about 69 %. The use of double sealed pumps, application of rupture disk to relief valves, and monthly I/M for other valves has an overall efficiency of about 91 %. Double mechanical seals and rupture disks are approximately 100 % efficient in reducing emissions from pumps and relief valves [Rentz, 1999 #114].

Fugitive emissions are monitored indirectly through tests on the workspace formaldehyde concentrations to which operators may be exposed. The Occupational Exposure Limits (OEL) depend on national regulations and Table 10.12 shows data for a selection of European countries.

Country	Formaldehyde Occupational Exposure Limit	
	8 hour (as ppm)	Short term (as ppm)
Belgium	1.0	2.0
Denmark	0.3	0.3
France	0.5	1.0
Germany	0.5	0.5
The Netherlands	1.0	2.0
Sweden	0.5	1.0
United Kingdom	2.0	2.0

Table 10.12: Occupational Exposure Limits for formaldehyde in Europe (at March 1999)
[CEFIC, 2000 #138]

10.4.5.4 Other channelled vents

Vents containing VOC may occur from loading and unloading operations, or from the purge of the equipment prior to a maintenance operation. Emissions during methanol and formaldehyde handling can occur from the decoupling of pipe connection, when the connections are not properly emptied before decoupling. The generic principles in Chapter 5 will be applicable for preventing and controlling these emissions.

The heat transfer fluid used in the oxide process has a vapour pressure and will incur breathing losses. Vents from the heat transfer fluid circuit in the oxide process are oxidised in the catalytic oxidiser.

10.4.5.5 Costs

Costs have been estimated (Table 10.13) for a typical plant employing a combination of pollution prevention and control techniques. In the context of the cash costs of formaldehyde production, and the range of cash cost margins, the costs were considered as “certainly significant but probably not crippling”. The hypothetical cases of tank vent scrubbers and fugitives detection appear relatively inexpensive in terms of annual cost, but are expensive in terms of the cost per tonne VOC abated [Environment Agency (E&W), 1998 #1].

Technique	Capital cost £000	Operating cost £000 pa	Annualised cost £000 pa	Cost/tonne VOC £	Cost/tonne Product £
Tank vent scrubbers ⁽¹⁾	45	2	9	3040	0.18
Fugitives ⁽²⁾	8	10	11	2730	0.22
Tail gas unit ⁽³⁾	250	13	54	146	1.07
Tail gas unit (+ steam credit) ⁽³⁾	250 ⁽⁴⁾	-17	24	65	0.47

1. Methanol is stored in atmospheric tanks. Even with a nitrogen pad system, there are losses on tank loading. Formaldehyde has 'medium' environmental impact and supports a case for control. Balance lines and a simple vent scrubber system are roughly costed, with the scrubber effluent joining the main process scrubber steam.
2. Fugitive emissions are generally low. The installation of high integrity equipment and fittings is most appropriate for new plant, and a simple LDAR programme is costed as an add-on technique.
3. Tail gas incineration is considered for the metal oxide process to remove VOCs (including dimethyl ether, methanol & formaldehyde) and oxidise CO. Economic cases are calculated with and without credits for steam production.
4. Does not include the Capital cost of steam raising equipment.

Table 10.13: Costs of abatement for formaldehyde production
[Environment Agency (E&W), 1998 #1]

10.4.6 Water emissions

The formaldehyde process does not generate waste water during normal operation, but arisings may occur because of incidents or from the rinsing of equipment prior to maintenance activity. It is good practice to place installations on a kerbed concrete floor, and to collect any spills in a tank. Plants typically have retention tanks or sumps to collect the waste water streams and rainwater (with possible contamination).

Most of the effluent arisings can be reworked into the process to dilute the formaldehyde product. Where this is not possible, effluents containing formaldehyde are readily degraded by biological treatment in an on-site or off-site WWTP. The overall formaldehyde removal efficiency in a WWTP can be 99.8 % [InfoMil, 2000 #83].

Direct emission to surface water is normal for non-polluted waste water from the cooling tower, boiler drain liquid and non-polluted rainwater as this reduces hydraulic load on the WWTP [InfoMil, 2000 #83].

10.4.7 By-products and wastes

10.4.7.1 Waste catalyst

The life of both the silver and oxide catalysts is adversely affected by long exposure to excessively high reaction temperatures and high throughput rates. This causes the catalyst to become irreversibly matted with carbon deposits that cause an excessive pressure loss across the catalyst bed [Ullmann, 1998 #80]. The main preventative technique is therefore to optimise reaction conditions and hence catalyst life. Conceptually, the consumption of formaldehyde catalyst (in terms of t/t formaldehyde produced) could be minimised by running the catalyst for a longer time before replacement with a fresh batch. However, an ageing catalyst gradually

loses its activity and selectivity, and eventually the continued catalyst operation is not justified. Reduced catalyst consumption is expected to continue as catalyst development work brings advances in catalyst deactivation rate and hence catalyst lifetime. De-activated formaldehyde catalyst is usually sent to a reclaimer for recovery of the valuable metals - either by recycling in a metallurgical processes, or electrolytic regeneration to produce new catalyst. More than 99 % of the silver is typically recovered from spent silver catalyst. Iron and molybdenum can also be reclaimed from spent oxide catalyst. After metal reclamation, the inert catalyst carrier requires disposal by the reclaimer, probably to landfill.

10.4.7.2 Solid para-formaldehyde by-product

Solid para-formaldehyde has a tendency to form in cold spots of pipes, in storage tanks and where liquid formaldehyde leaks from equipment (e.g. drips from pumps). Para-formaldehyde is also recovered during maintenance operations, for example from filters installed upstream of the pumps. Internal deposits of solids can be prevented by improved heating, insulation and flow circulation. External solid deposits can be swept-up or dissolved in hot water. Where possible the solid is re-dissolved either in hot water (for recycling into the process) or in ammonia (for re-use, for example, in a hexa-methylene tetramine unit). Otherwise, the solid is drained into containers and incinerated.

10.5 Best Available Techniques

As explained in Chapter 6, BAT for a particular LVOC process is determined by considering the three levels of BAT in the following order of precedence: illustrative process BAT (where it exists); LVOC Generic BAT; and finally any relevant Horizontal BAT. The following techniques are BAT for the illustrative process of formaldehyde production.

10.5.1 Process selection

Formaldehyde is produced either by air oxidation of methanol on a metal oxide catalyst (oxide process) or by air oxy-dehydrogenation of methanol on a silver catalyst (silver process). For a new unit, both the oxide process and the silver process (with total conversion) can be BAT. The process choice will be dependent on local factors such as production capacity and product quality. Many recently constructed plants have opted for the newer oxide process, however there is still an important role for the silver process.

The silver process (with partial conversion) has the same environmental performance as the other processes but delivers less steam excess due to the heat needed to separate and recycle the methanol. However, it produces high concentration solutions (above 60 %) which can be used on-site and save energy in the downstream products manufacturing. In this case, the silver process (with partial conversion) is also BAT.

The oxide process and silver process (with partial methanol conversion) can be BAT when a low methanol content in the formaldehyde solution is required (below 0.5 % by weight). This low content is also achieved with the silver process with total methanol conversion if additional equipment is provided.

10.5.2 Consumption of energy and raw materials

Energy. The overall process, including the off-gas treatment, is exothermic and the energy excess can be recovered by conversion into steam (for site re-use). Alternatively the off-gas from the silver process can be combusted in a motor engine producing simultaneous electricity

and steam. BAT consists in managing efficiently the energy balance of the formaldehyde unit taking into account the surrounding site.

Water. The formaldehyde process is a net water consumer. BAT consists in reusing aqueous waste streams to absorb and dilute formaldehyde (unless it would adversely affect finished product quality).

10.5.3 Air emissions

BAT is to connect the vent streams from the absorber and from the storage and loading/unloading systems to a recovery system (e.g. condensation, water scrubber) and/or to a vent gas treatment (e.g. motor engine, thermal/catalytic oxidiser, central boiler plant). Such equipment can be designed to achieve a formaldehyde emission of $< 5 \text{ mg/Nm}^3$ (daily average).

Silver process. BAT for abatement of the absorber off-gases in the silver process includes gas engines and dedicated thermal oxidation with steam generation. This can achieve emission concentrations (as dry exhaust gas at standard conditions and related to an oxygen content of 3 Vol. %) of:

- carbon monoxide: 50 mg/Nm^3 as a daily average (0.1 kg/t formaldehyde 100 %)
- nitrogen oxides (as NO_2): 150 mg/Nm^3 as a daily average (0.3 kg/t formaldehyde 100 %).
Note that techniques to reduce CO may have an adverse effect on NO_x emissions.

Silver process off-gases can be combusted in gas engines (to produce steam and electricity) and this is also BAT. This technique may be preferable as it combines high-energy efficiency with the low emissions of thermal oxidation, but it may not be applicable in every installation.

The combustion of off-gases in a central boiler plant (mixed with other fuels) can also be BAT and may achieve similar emission standards.

Oxide process. BAT to treat the reaction off-gas from the oxide process consists of a dedicated catalytic oxidation system, preferably with steam generation for export (although the economic case may be more marginal than with the silver process). This can achieve emission concentrations (as dry exhaust gas at standard conditions and related to an oxygen content of 3 % vol.) of:

- carbon monoxide: $<20 \text{ mg/Nm}^3$ as a daily average (0.05 kg/t formaldehyde 100 %)
- nitrogen oxides (as NO_2): $<10 \text{ mg/Nm}^3$ as a daily average.

Storage and handling. BAT for the design of methanol tanks is to take account of the flammable properties of methanol in air and to reduce the vent streams by such techniques as back-venting on loading/unloading. BAT for the polluted streams from the storage of methanol and formaldehyde include:

- thermal or catalytic oxidation
- adsorption on activated carbon (only for methanol)
- absorption in water, further recycled to the process
- connection to the suction of the process air blower (only for formaldehyde storage vents, and provided the necessary safety precautions).

Fugitives. BAT for the prevention of fugitive emissions to atmosphere from formaldehyde production is described in Section 6.3.

10.5.4 Water emissions

BAT for the minor arisings of waste water is to maximise their re-use as dilution water for the product formaldehyde solution (unless this adversely affects product quality). When re-use is not possible, BAT is biological treatment in an on-site or off-site waste water treatment facility, taking necessary measures to ensure that the formaldehyde concentration does not inhibit biological degradation.

10.5.5 By-products and wastes

BAT for catalyst waste is to first maximise the catalyst life by optimising reaction conditions and then to reclaim the metal (silver, iron or molybdenum) content of any spent catalyst to produce fresh catalyst for re-use in the reaction.

BAT for the build-up of solid para-formaldehyde is to prevent its formation in process equipment by optimising heating, insulation and flow circulation. Any unavoidable arisings are to be re-dissolved either in hot water (for re-use in the process) or in ammonia (for re-use in other processes). Where this is not possible it can be drained-off and incinerated.

10.6 Emerging techniques

Direct production from methane would obviate the material losses and energy consumption of production via methanol. There are some reports of this being achieved but the poor selectivity and low level of conversion necessitate complicated separation stages that prevent commercial adoption [Wells, 1991 #60]. In addition, the 600 °C temperatures that are needed to speed the rate of reaction, also trigger the rapid decomposition of formaldehyde [Weissermel & Arpe, 1993 #59].

11 ILLUSTRATIVE PROCESS: ACRYLONITRILE

11.1 General information

Uses. Acrylonitrile is an intermediate monomer used world-wide for several applications. The majority of European acrylonitrile is used in the production of acrylic fibre, with ABS representing the next most important end user (Figure 11.1). The European end uses broadly reflect the world situation.

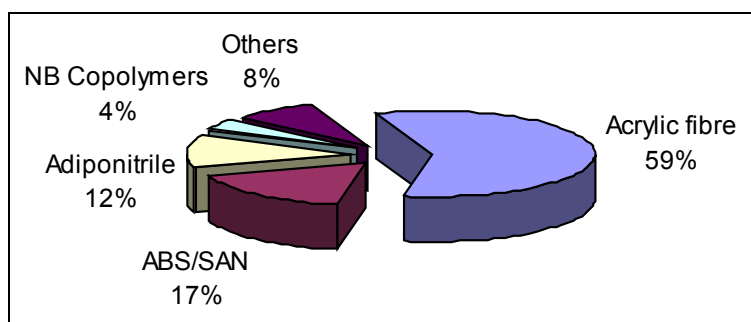

Figure 11.1: Uses of acrylonitrile in Europe
[CEFIC, 2000 #85]

European production. The EU (and Western Europe in total) has seven operational installations and these account for a nameplate capacity of 1165 kt/yr (Table 11.1).

Country	Location	Nameplate capacity (kt/yr)
Germany	Worringen	280
	Schwedt	70
Italy	Gela	105
	Assemini	85
Spain	Tarragona	125
The Netherlands	Geleen	200
UK	Seal Sands	300
Total EU		1165

Table 11.1: European acrylonitrile production
[CEFIC, 2000 #85]

Market. From 1988 to 1993, the average production capacity in Europe declined by 3 % per year, but during the last five years the situation has improved and the rate has increased to 3 % per year (Figure 11.2). This means that Europe has shown zero growth over the last ten years, even though the world average production capacity growth has been 3 % per year over the last ten years [CEFIC, 2000 #85].

The 1998 European demand for acrylonitrile was 1126 kt/yr. During the last ten years, the average demand has decreased by 0.5 % per year in Europe, whereas world-wide it has increased by 2.1 % per year in the same period [CEFIC, 2000 #85].

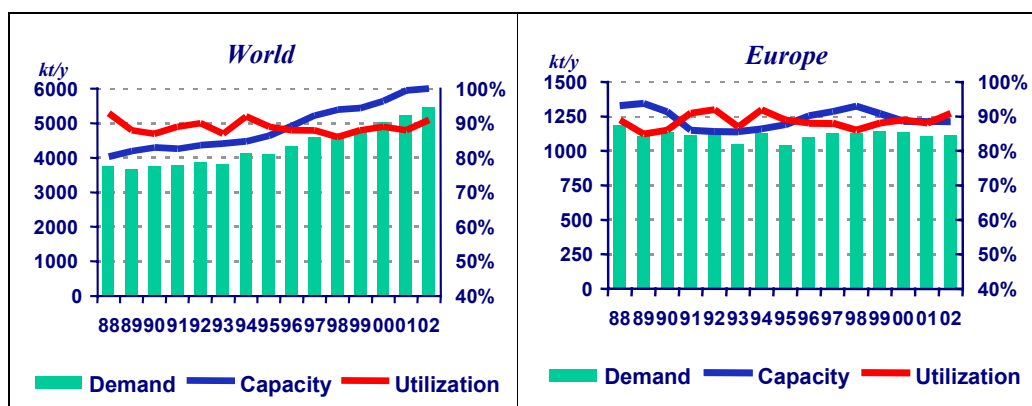

Figure 11.2: Acrylonitrile demand and production capacity in the world and Europe
PCI Fibres and Raw Materials in [CEFIC, 2000 #85]

Employment. CEFIC have estimated [CEFIC, 2000 #85] that a medium capacity acrylonitrile plant employs a total of 840 people (composed of 100 in direct on-site manpower, 40 indirect on-site manpower and 700 indirect off-site). The EU's seven acrylonitrile plants therefore account for around 6000 direct and indirect jobs. When taking into account the direct downstream acrylonitrile users, the number of jobs in the EU will be around 30000 [CEFIC, 2000 #85].

Production costs. In 1998, the market prices for acrylonitrile ranged from 286 - 543 Euro/t with an average of 401 Euro/t [CEFIC, 2000 #85]. Figure 11.3 shows the 1998 production costs of a typical acrylonitrile plant. These costs are based on the following assumptions and approximate rates of raw material usage:

- investment return (10 years) 200 MEuro (ISBL cost for a 200 kt acrylonitrile/year new plant installed in Western Europe in an existing complex, including storage, ammonium sulphate recovery, vents thermal oxidiser, aqueous effluent treatment)
- 1.05 tonnes propylene / tonne acrylonitrile @ 290 Euro/t
- 0.5 tonnes ammonia / tonne acrylonitrile @ 140 Euro/t
- 0.1 tonnes sulphuric acid / tonne acrylonitrile @ 45 Euro/t
- 0.13 tonnes ammonium sulphate / tonne acrylonitrile @ 60 Euro/t
- 0.11 tonnes hydrogen cyanide(HCN) produced / tonne acrylonitrile @ 450 Euro/t (as there is no market price for HCN this is the typical variable cost of HCN production by methane ammoxidation in the Andrussov process).

The cash costs for acrylonitrile have been estimated for West European leader plants in 1997 [Environment Agency (E&W), 1998 #1]. For a plant with capacity of 200 kt/yr, the total capital replacement cost would be £136M. Like most commodity petrochemicals, the cost of feedstock for acrylonitrile production is a dominant element in the cash costs and accounts for most of the variable cost of £388 per tonne. With total fixed costs of £44/tonne this gives a total cash cost of £432/tonne.

In addition to the costs of production, a key parameter is the margin or profit element. The price of acrylonitrile is set by plants at the least competitive end of the cost curve. The steepness of the cash cost curve is an indicator of the potential for a competitive producer to make profit, and this is shown by the difference between the cash costs of leader and laggard plants. In 1997 the lead acrylonitrile producer had cash costs of £432/tonne and the laggard cash costs of £510/tonne [Environment Agency (E&W), 1998 #1].

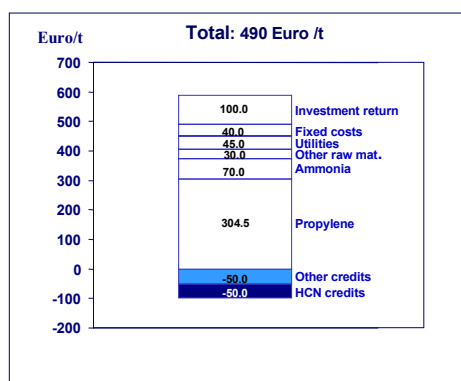

Figure 11.3: Typical production costs of acrylonitrile in 1998
[CEFIC, 2000 #85]

The history of acrylonitrile cash cost margin is shown in Figure 11.4 for West European leader plants. The shape of the curve represents not only differences in efficiency and scale of plants, but also different feedstock sources. The margins fluctuate widely, largely synchronised with the industry business cycle. This indicates that changes in costs cannot be passed on to consumers. Both buyers and sellers are well informed in these markets and will press for the benefits of over-supply or under-supply respectively.

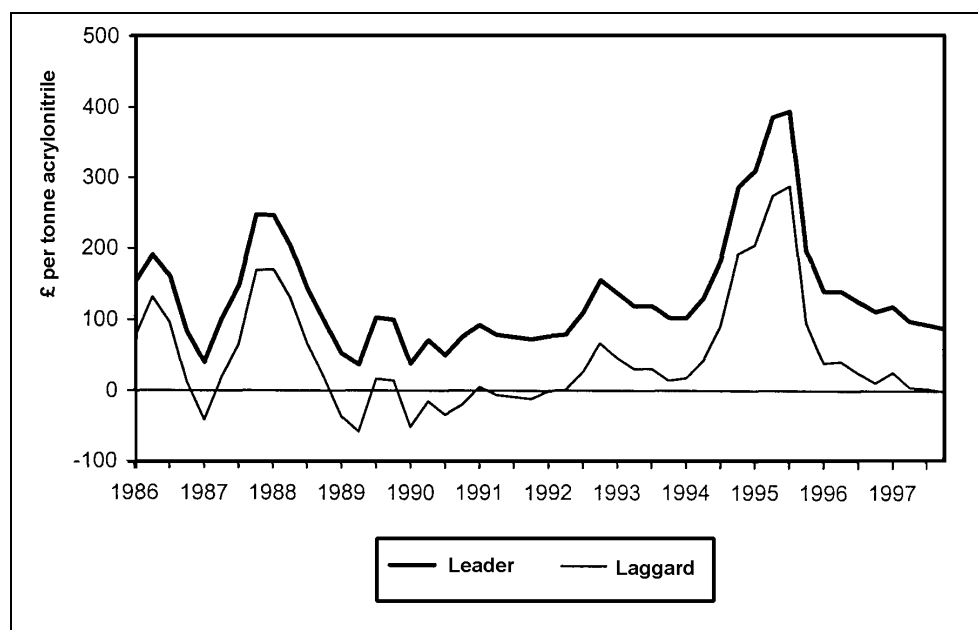

Figure 11.4: Acrylonitrile cash cost margin history
[Environment Agency (E&W), 1998 #1]

11.2 Applied processes and techniques

The BP/SOHIO process accounts for 95 % of world-wide acrylonitrile capacity and is used in all EU plants. The process is a vapour phase, exothermic ammoxidation of propylene using excess ammonia in the presence of an air-fluidised catalyst bed. The catalyst is a mixture of heavy metal oxides (mainly molybdenum, bismuth, iron, antimony and tellurium) on silica. The process can use other catalysts based on depleted uranium, but these are not used in Western Europe.

A fixed bed catalyst system also exists, but is no longer used in the EU and is, in any event, less efficient than the BP/SOHIO process. Older processes for acrylonitrile manufacture (e.g. dehydration of ethylene oxide cyanohydrin or addition of hydrogen cyanide to acetylene) no longer have economic importance.

Several secondary reactions take place, and in addition to acrylonitrile, the BP/SOHIO process has three main co-products, namely:

- **hydrogen cyanide**, which is either transformed into other products on site; sold as a product (if a use is available); disposed of by incineration; or a combination of all three
- **acetonitrile**, which is purified and sold as a product, and/or disposed of by incineration
- **ammonium sulphate**, which is either recovered as a product (e.g. as a fertiliser), or destroyed elsewhere on site.

The main steps of the BP/SOHIO process are described below and shown schematically in Figure 11.5.

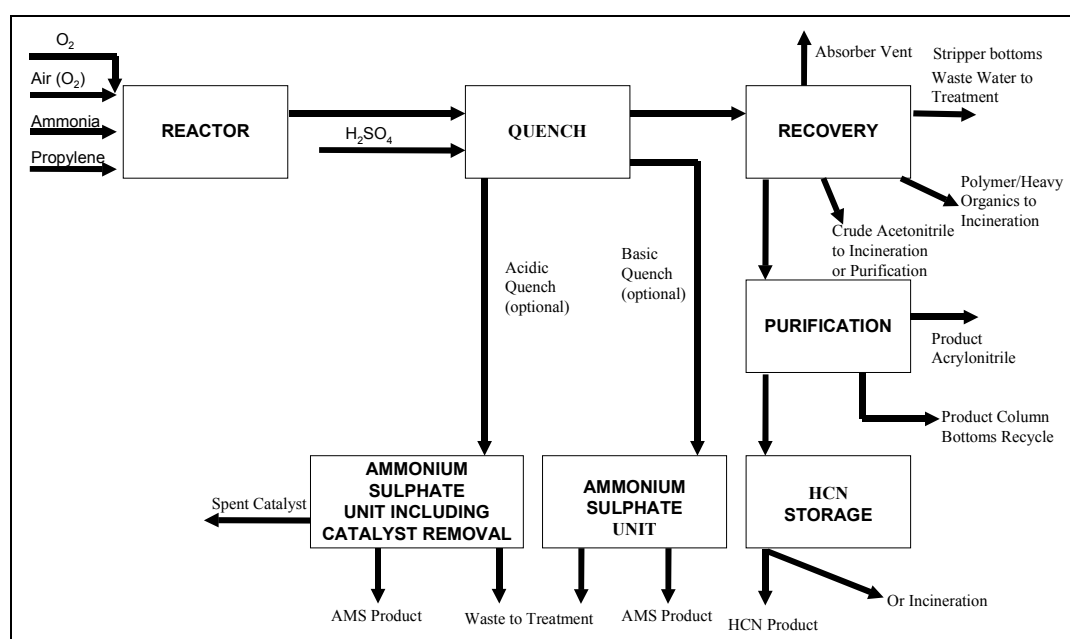

Figure 11.5: The BP/SOHIO acrylonitrile process
[CEFIC, 2000 #86]

11.2.1 Raw materials

On chemical complexes with a steam cracker and ammonia plant, the propylene and ammonia may be supplied directly to the acrylonitrile plant by pipeline. Other raw materials are supplied by a combination of pipeline, rail or sea transportation. Propylene and ammonia raw materials are usually stored on-site at atmospheric pressure (in refrigerated tanks) or under pressure (at ambient temperature). Sulphuric acid is stored in atmospheric storage tanks. Air is used as the oxygen source for the reaction, although some plants supplement this with pure oxygen.

11.2.2 Reaction

Propylene is reacted with slight excesses of oxygen and ammonia in a fluidised-bed reactor. The catalyst is typically bismuth-molybdenum based but other commercially available catalysts are given in Table 11.2. The conversion to acrylonitrile requires operating temperatures of 400 - 500 °C, pressures of 150 - 250 kPa and a residence time of a few seconds. The conversion rate inside the reactor is high, and so recycling is not necessary. By reducing the quantity of by-

products that have to be recovered or removed, the efficiency of acrylonitrile catalysts has increased to over 75 % selectivity.

Large quantities of hydrogen cyanide and acetonitrile by-products are formed in the reactor and also smaller quantities of acrolein, acetic acid, acrylic acid, propionitrile, and methacrylonitrile. The reaction also produces a large volume of ‘water of reaction’ – in total about 1.5 tonnes per tonne of acrylonitrile, of which about 1 tonne comes from the main reaction and about 0.5 tonnes from side reactions.

The reactor off-gas contains carbon oxides (from the total oxidation of propylene) and propane (due to impurities in the propylene feed). Some catalyst fines are entrained with the reaction gas and are returned to the reactor after capture by cyclones (either inside or outside the reactor). Specially formulated make-up catalyst is regularly added to acrylonitrile reactors to maintain the activity and selectivity of the catalyst, and to replace lost catalyst fines.

11.2.3 Quench system

The reactor off-gas must be quenched to the condensation temperature and the excess ammonia removed. Due to the presence of impurities, it is impossible to recycle the ammonia and it must be removed with sulphuric acid. The two alternatives for the quench system are:

- quench and acid treatment in one step (‘acidic quench’)
- quench and acid treatment in two, separate steps (‘basic quench’).

In the ‘**acidic quench**’ reactor off-gas is contacted with a circulating solution of sulphuric acid and ammonium sulphate in water. Fresh sulphuric acid is added to keep the system acidic and to avoid ammonia breakthrough. Water or, more preferably, recycle streams from the plant are added to balance the evaporative losses incurred by quenching hot reactor off-gas. Catalyst is also removed in the quench flow and becomes entrained in the ammonium sulphate liquor thus necessitating a purge to avoid over-saturation of ammonium sulphate in the circulating solution. Catalyst is removed from the purge by settling or/and filtration and the ammonium sulphate is recovered by crystallisation to produce a saleable by-product. The crystallisation stage generates a waste liquor stream that contains some ammonium sulphate, organics and possibly catalyst fines.

Advantages	Disadvantages
<ul style="list-style-type: none"> • Higher recovery efficiency of acrylonitrile due to low pH • Lower polymer production in the quench section • Opportunity to re-use waste water streams 	<ul style="list-style-type: none"> • Additional energy consumption for crystallisation unit

In the ‘**basic quench**’ the two process steps can be either carried out in a single vessel with two stages, or in two separate vessels. In the first step, reactor off-gas is quenched with water. Water losses are made-up by adding fresh water or recycling plant waste water streams. Only the catalyst fines are removed from the reactor off-gas. The addition of water causes the formation of high boiling organic compounds (by the process of oligomerisation) and ammonium salts (by the neutralisation of ammonia with organic acids). These must be purged from the system and this produces a waste stream containing ammonium salts, organic acids and organic polymers.

In the second step the gas is treated isothermally with sulphuric acid to remove excess ammonia. Fresh acid has to be added to maintain the acidity, but no additional water is required.

Advantages:	Disadvantages:
<ul style="list-style-type: none"> • Removal of catalyst fines and ammonia separately • Only a small waste stream containing ammonium sulphate is produced 	<ul style="list-style-type: none"> • Lower recovery of acrylonitrile due to high pH in the quench • Higher polymer production in the quench

11.2.4 Ammonium sulphate unit

The ammonium sulphate may be treated by crystallisation to form a saleable product. Some processes incorporate the crystallisation step in the quench section of the main process, others remove the ammonium sulphate solution and produce the crystal product in a separate unit. The effluent streams from the crystallisation process are either treated biologically, physically, chemically or incinerated in appropriate central facilities.

11.2.5 Recovery section

After ammonia removal in the quench organics are normally removed from the reactor off-gases by scrubbing with chilled water. The vent gases from the scrubber contain mainly nitrogen (originating from the air feed to the reactor), carbon oxides, propane, un-reacted propylene and oxygen, and minor amounts of acrylonitrile, hydrogen cyanide and other organics. Depending on the plant configuration other impurities may exit the process by this route.

The scrubber liquor is passed to an extractive distillation column (recovery column) where the acrylonitrile and hydrogen cyanide products are separated in the overheads from the acetonitrile. The acetonitrile is preferentially refined for sale as a product, but it may be stripped in a further column and incinerated (with energy recovery). The acetonitrile may also pass (as an aqueous solution) from a side-stream of the recovery column to the scrubber where it is stripped by the off-gas. The recovery column bottoms contain high boiling organic compounds (for incineration) and some ammonium and/or sodium salts of organic acids (for waste water treatment).

11.2.6 Purification

The overheads from the recovery column, containing acrylonitrile, hydrogen cyanide and a small amount of water, are distilled to produce acrylonitrile and hydrogen cyanide products. In some plant designs, the 'heads column' (to refine the hydrogen cyanide) and the 'drying column' (to remove the water) are combined to reduce energy consumption.

The hydrogen cyanide may be incinerated, or transformed into other products on-site, or sold (if a market is available). If stored, it has to be maintained at a low temperature and kept acidic, by the addition of acetic acid, phosphoric acid, sulphuric acid and sulphur dioxide, to prevent polymerisation. Due to the reactive and toxic nature of hydrogen cyanide it is not stored for periods longer than a few days. If the material cannot be sold or used, then it is burnt. All sites must have therefore the capability to destroy all of the hydrogen cyanide produced.

The hydrogen cyanide by-product may be further reacted in separate installations (outside the scope of this process) to produce [InfoMil, 2000 #83]:

- sodium cyanide (NaCN) by reaction with caustic soda solution
- acetone cyanohydrin (ACH) with acetone
- benzaldehyde cyanohydrin (BCH) with benzaldehyde
- 1,4-diamino butane (DAB) with acrylonitrile and hydrogen
- pyrrolidine (PRD) as a by-product of DAB.

The final step is the purification of the acrylonitrile that is taken as a side-stream from the acrylonitrile column. The bottom of the acrylonitrile column contains some high boiling-point nitriles that have to be purged from the purification section of the plant. In order to protect against possible polymerisation reactions during the storage of acrylonitrile, small quantities of inhibitors, such as MEHQ (monomethyl ether of hydroquinone), are added.

The drying column and the acrylonitrile column may be operated at low pressure to decrease the distillation temperature and to reduce acrylonitrile polymer formation.

11.2.7 Auxiliary chemicals

A variety of auxiliary chemicals are used within the process, and these may include:

- sulphuric acid (for neutralisation of unreacted ammonia)
- catalyst (heavy metal oxides such as Mo, Bi, Fe, Sb, or Te on silica)
- hydroquinone (as an in-process acrylonitrile stabiliser)
- monomethyl ether of hydroquinone (as a product acrylonitrile stabiliser)
- acetic acid (for in-process pH control, and hydrogen cyanide stabilisation)
- soda ash (for in-process pH control)
- sulphur dioxide (hydrogen cyanide stabiliser)
- phosphoric acid (hydrogen cyanide stabiliser).

11.2.8 Energy aspects

The ammoxidation of propylene to acrylonitrile is an exothermic reaction. If the core plant (reactor area, quench area, recovery, purification) is considered as a black box receiving enthalpy (boiler feed water, steam, electricity) and delivering enthalpy (steam, condensates), then the balance is positive (i.e. that the core plant is able to export energy). The net enthalpy excess of an acrylonitrile core plant is in the range 340 - 5700 MJ / t Acrylonitrile. The heat of reaction is used to produce steam for such uses as covering the heat needs of the acrylonitrile process; driving the reaction air compressor (via a turbine); and exporting high or low pressure steam to the site.

After scrubbing, the off-gas is thermally oxidised with energy recovery. Heat is also recovered from the stripped scrubbing water to preheat the recovery column feed and vaporise ammonia and propylene. Latent heat of vaporisation of propylene and ammonia is recovered to chill the scrubbing water.

11.3 Consumption and emission levels

Performance data is provided here on raw material and energy consumption and on levels of gaseous and liquid effluents, co-products and wastes produced during normal operation of an acrylonitrile plant. Plant effluent streams are quantified, both before and after treatment. Streams before treatment are referred to as 'effluent streams' and the term 'emissions' describes streams that are (finally) discharged to the environment.

11.3.1 Raw materials and energy consumption

11.3.1.1 Influencing factors

The consumption of raw materials and energy in the acrylonitrile process can be influenced by such factors as catalyst selection, production rate and recovery plant configuration [CEFIC, 2000 #107].

Catalyst selectivity. The stoichiometric equations for propylene ammoxidation and the main competing side-reactions are as follows:

	Reaction formula	Energy (ΔH)
Acrylonitrile formation	$C_3H_6 + NH_3 + 1.5O_2 \rightarrow CH_2=CHCN + 3H_2O$	-515 kJ/mol C_3H_6
HCN formation	$C_3H_6 + 3NH_3 + 3O_2 \rightarrow 3HCN + 6H_2O$	-942 kJ/mol C_3H_6
Acetonitrile formation	$C_3H_6 + 1.5NH_3 + 1.5O_2 \rightarrow 1.5CH_3CN + 3H_2O$	-545 kJ/mol C_3H_6
CO formation	$C_3H_6 + 3O_2 \rightarrow 3CO + 3H_2O$	-1078 kJ/mol C_3H_6
CO ₂ formation	$C_3H_6 + 4.5O_2 \rightarrow 3CO_2 + 3H_2O$	-1926 kJ/mol C_3H_6

Although acrylonitrile is the principal product, hydrogen cyanide and acetonitrile are valuable co-products to some producers. The unwanted water and carbon oxides by-products are produced by the oxidation of propylene, acrylonitrile and associated by-products.

Acrylonitrile yield, expressed as the number of moles of acrylonitrile produced per mole of propylene consumed, is a measure of reactor performance and it shows how efficiently and selectively the catalyst converts propylene to acrylonitrile. Some loss in selectivity to acrylonitrile may be offset by credits for co-products (HCN, acetonitrile), depending on their value to individual producers.

Propylene costs dominate the production cost of acrylonitrile, accounting for ca.60 % of these costs. Ammonia costs typically represent ca. 15 % of production costs. The commodity nature of the business and the resulting sensitivity of the process economics to propylene prices emphasise the importance of catalyst selectivity to valued products.

Catalyst developments have enabled the acrylonitrile yield to improve from ca.62 % to 77 - 80 % since the introduction of the Sohio process in 1960. This has been achieved through a combination of improved catalyst formulations, better catalyst manufacturing procedures and the use of promoters and moderators. Table 11.2 gives the reaction yields (excluding the losses in the separation step) from commercially available catalysts.

Catalyst composition	Acrylonitrile yield (%)*
Bismuth phosphomolybdate	62
Uranium antimonate (C-21)	68
Promoted bismuth molybdate (C-41)	70 - 72
Promoted bismuth molybdate (C-49)	73 - 75
Iron tellurium antimonate (NS733B/C/D)	72 - 77
Uranium iron antimonate (MAC-3)	75 - 77
Multi-component bismuth molybdate (C-49MC)	77 - 80
*Estimates only as producers regard actual catalyst performance data as commercially confidential.	

Table 11.2: Reaction yields from acrylonitrile catalysts
[CEFIC, 2000 #107]

Influence of production rate. The kinetic distribution of reaction products is dependent on a number of factors (e.g. feed ratios, catalyst loading, temperature and pressure). The selectivity to acrylonitrile is adversely affected by increases in pressure and catalyst loading (i.e. acrylonitrile formation is less efficient at higher production rates).

Influence of recovery plant configuration. The use of raw material and energy are also affected by the efficiency of the product recovery and purification stages. This is a function of each individual plant's configuration.

11.3.1.2 Consumption of raw materials

Propylene and ammonia are the major raw materials consumed in acrylonitrile manufacture, but 'make-up' catalyst is also a significant consumable. Air may also be considered as a raw material and it may be enriched with oxygen to increase the reactor capacity. Sulphuric acid is used to neutralise the unconverted ammonia, and its consumption is linked to the ammoxidation reaction performances.

The unit cost and specific consumption of raw materials are kept confidential by producers due to their impact on the competitiveness of the manufacturing process, but Table 11.3 gives typical ranges. Since the consumption rates of raw materials are linked, no one unit could simultaneously achieve the lowest figures for all parameters. The ranges of values are dependent on the catalyst (type, age, 'make-up' catalyst addition strategy), the processing plant

configuration and the operating conditions. The theoretical minimum consumptions (of the main reaction only with 100 % yield) which would be 0.78 t propylene and 0.33 t ammonia / tonne of acrylonitrile product. However, in practice 85 % of the propylene feed is converted to saleable products (acrylonitrile, acetonitrile, hydrogen cyanide).

	Consumption range *
Propylene consumption	1.03 - 1.15 t C ₃ H ₆ / t Acrylonitrile
Ammonia consumption	0.45 - 0.55 t NH ₃ / t Acrylonitrile
Make-up catalyst consumption	0.3 - 0.7 kg catalyst / t Acrylonitrile
Note* In-tank values taking into account losses throughout the quench, recovery and purification areas	

Table 11.3: Typical raw material consumptions
[CEFIC, 2000 #107]

11.3.1.3 Consumption of energy

Propylene ammoxidation is a highly exothermic reaction. Acrylonitrile plants are net exporters of energy as the heat of reaction is used to generate high pressure steam, which in turn can be used to drive air compressors, exported and provide energy to downstream separation and purification units. The energy export range is 340 to 5700 MJ/t acrylonitrile [CEFIC, 2000 #107]. The range is wide because acrylonitrile plants generate a number of gaseous and liquid effluent streams that may be recovered as fuel in furnaces, power plants or steam boilers. Optimisation of the energy balance therefore is typically done on a site-integrated basis. In addition, each European acrylonitrile plant is differently integrated into the total site thus giving different plant configurations and energy recovery techniques. When comparing the energy performances of acrylonitrile units, the electricity needed to produce the oxygen (when used to enrich the air) should also be considered for sake of completeness.

11.3.2 Gaseous streams

The gaseous vent streams arising from the core plant were shown in Figure 11.5. In many cases the vent stream will be flared, oxidised (thermally or catalytically), or sent to boiler or power plant (either attached to the core plant or a central site facility). This is often combined with other streams, making it difficult to establish the actual contribution of a specific effluent stream to the overall emission, but by convention the combustion efficiency is assumed as 100 %.

11.3.2.1 Absorber vent

The absorbers on the reactor off-gases (after ammonia removal) have an overhead stream that contains mainly nitrogen, unreacted propylene, propane (impurity in the feed propylene), CO, CO₂, argon and small amounts of reaction products. The stream is normally saturated with water. The VOC (propane) levels depend upon the propylene feed purity but normally the effluent stream prior to treatment contains pollutants in the ranges shown in Table 11.4.

There is one European plant that currently vents this stream directly to atmosphere but this situation is being addressed by the installation of an oxidation facility. The rest of European plants already subject the stream to thermal or catalytic oxidation, either in a dedicated unit or in a central site facility, to give the emission ranges also shown in Table 11.4.

Parameter (all values as kg/t acrylonitrile)	Pre-treatment (raw absorber vent stream)		Post-treatment (after oxidation)	
	CEFIC data	EC data	CEFIC data ^(e)	EC data
VOC	15 – 80 Exceptionally 130 ^(a)	^(f)	0 ^(b)	^(g)
CO	50 – 100	100 - 150	0 ^(b)	0
CO ₂	70 – 400		190 – 730 (900) ^(a)	
NO _x	0.03 - 0.04		0.5 ^(c) – 2.0 ^(d)	
Ammonia		0.1 – 0.3		0.1 – 0.3
Hydrocyanic acid		0.5 – 1.5		0.2 – 0.3
Hydrogen		0.5 – 1.0		0 – 0.8

a. When acetonitrile is rejected from the process via the absorber vent stream.
b. Assigned a value of 0 by convention in case of treatment by oxidation
c. When the absorber vent stream is destroyed in a central facility separate numbers are not available. The analysis is further complicated as this stream is often destroyed in combination with other streams.
d. This range includes 2 typical configurations: dedicated acrylonitrile off-gas thermal oxidiser, or multipurpose incinerator burning also other liquid effluent streams. The lowest figure corresponds to a two-step combustion system intended to reduce the NO_x emission.
e. The range excludes the European plant without vent treatment.
f. VOC components before treatment are (in kg/t acrylonitrile): Acetonitrile (1 - 7), Acrolein (0.1 - 0.3), Acrylonitrile (0.2 – 3.0), Ethene (5 – 9), Propane (50 – 70) and Propene (25 – 40) [EC VOC Task Force, 1990 #116].
g. VOC components after treatment are (in kg/t acrylonitrile): Acetonitrile (0 – 1.8), Acrolein (0), Acrylonitrile (0.2 – 0.7), Ethene (0 – 3.8), Propane (0 – 30) and Propene (0 – 15) [EC VOC Task Force, 1990 #116].

Table 11.4: European absorber vent concentration ranges before and after treatment [CEFIC, 2000 #107] [EC VOC Task Force, 1990 #116]

11.3.2.2 Miscellaneous process vents

There are a number of miscellaneous vents within the core plant (e.g. from distillation columns and tank vents) which are treated by flares, thermal oxidation and water scrubbing. The oxidation techniques will have no VOC emission to atmosphere but there will be combustion gases. Scrubbing techniques will reduce the acrylonitrile emissions to less than 20 mg/m³.

A Dutch acrylonitrile plant in 1992 was reported [EEA, 1999 #118] to have a VOC emission of 0.44 kg / tonne of acrylonitrile production (at a production rate of 166 kt/yr). The VOC emissions were attributed to leakages from appendages / pumps (62 %), flaring / disruptions (35 %), storage & handling (2 %), combustion (0.1 %) and other process emissions (1 %). The overall VOC emission profile was methane (1 %), ethylene (3 %), acrylonitrile (18 %), HCFCs (1 %) and other hydrocarbons (77 %).

Acrylonitrile is emitted from crude acrylonitrile storage tanks, acrylonitrile run tanks, product storage tanks, and during loading into railroad tank cars and barges. The use of internal floating screens may be used in place of fixed roof tanks to reduce acrylonitrile emissions by up to 95 % and water scrubbers have removal efficiencies of up to 99 % (see Table 11.5).

	Emission factor from storage vents (g/t product)	
	Before treatment	After treatment (water scrubber)
Storage (crude acrylonitrile) ⁽¹⁾	48	0.5
Storage (acrylonitrile run-down tanks) ⁽¹⁾	128	1.3
Storage (acrylonitrile) ⁽¹⁾	531	5.3
Handling (tank car loading)	167	1.7
Handling (barge loading)	150	1.5

1. Fixed roof tanks, half full, 27 °C

Table 11.5: Emissions from acrylonitrile storage and handling [Rentz, 1999 #114]

An actual example of performance data is given in Table 10.6.

Source	Emission type	Pollutant	Emission / generation factor (kg/tonne acrylonitrile product)
Absorbers (prior to incinerator)		Acetonitrile	49 *
		Propane	54 *
		Propene	24 *
		CO	67 *
		CO ₂	194 *
		Acrylonitrile	1.30 *
		HCN	4.22 *
Start-up heater	Combustion	CO	Discontinuous, Negligible emission factor Negligible emission factor
		NO _x	
		VOC	
Outlet flares (99 % efficiency)	Point sources	Acrylonitrile	0.008
		HCN	0.015
		SO ₂	0.038
		C ₃ H ₆ /C ₄ H ₈	0.0005
		NO _x	1.08
Off gas scrubbers	Point sources	Acrylonitrile	0.004
		HCN	0.019
Acrylonitrile plant, tank yard, (un)loading	Fugitive	Acrylonitrile	0.038
		HCN	0.002
		VOC total	0.022
		NH ₃	0.003

* This is an effluent load, not an emission factor as the waste gas stream is prior to treatment)

Table 11.6: 1999 air emissions from an acrylonitrile plant in the Netherlands [InfoMil, 2000 #83]

11.3.3 Aqueous streams

The aqueous streams arising from the core plant were shown in Figure 11.5. As with the gaseous streams, it is difficult to quantify contributions to the central biological treatment facility. Every plant assigns the various streams to treatment techniques in different proportions but the European range for Total Carbon Flow from acrylonitrile plants is estimated at 0.4 - 1.0 kg/t acrylonitrile [CEFIC, 2000 #107].

11.3.3.1 Quench section

The reaction generates water, which is purged in the form of a stripped effluent. The quench effluent stream(s) contain a combination of ammonium sulphate and a range of, generally, high boiling organic compounds in an aqueous solution. In most cases the ammonium sulphate is recovered as a crystal co-product or is treated to produce sulphuric acid. The remaining stream containing heavy components can be treated to remove sulphur and then incinerated or bio-treated. The stream containing the light components is bio-treated or recycled to the acrylonitrile plant for rework. Table 11.7 gives the effluent data before and after treatment.

		Pre-treatment (raw quench effluent)	Post-treatment* (final emission)
Effluent (combined streams)	Units	Range	Range
Total flow	kg/t acrylonitrile	350 – 900	-
Ammonium sulphate	wt %	15 – 37	-
Total Carbon	ppm wt	15000 – 25000	-
Total Carbon Flow	kg/t acrylonitrile	5.3 – 18	0 – 1**

* Treatment may be biological or by incineration.

** By convention at least 90 % of TOC is destroyed in bio-treatment.

Table 11.7: European ranges for quench effluent before and after treatment [CEFIC, 2000 #107]

11.3.3.2 Stripper bottoms

The water used to absorb the organic species in the absorbers has the acrylonitrile and hydrogen cyanide removed in the recovery column. The remaining water is treated in the stripper column where the light components rise up the column and can be recovered as crude acetonitrile. The heavy components and excess water produced in the reactors are removed at the bottom of the column as an aqueous waste stream. This stream is treated by evaporative concentration. The distillate is bio-treated and the concentrated heavy stream burnt (with energy recovery) or recycled. The effluent concentrations before and after treatment are given in Table 11.8.

		Pre-treatment (raw stripper bottoms)	Post-treatment* (final emission)
Effluent	Units	Range	Range
Total flow	kg/t acrylonitrile	500 - 2000	-
Total Carbon	ppm wt	4000 - 20000	-
Total Carbon Flow	kg/t acrylonitrile	8 - 15	0.1 - 0.4 **

* Treatment may be biological or by incineration.
** By convention at least 90 % of TOC is destroyed in bio-treatment.

Table 11.8: European ranges for stripper bottoms effluent before and after treatment [CEFIC, 2000 #107]

11.3.3.3 Discontinuous waste water

The cleaning of process equipment for operational reasons or prior to maintenance generates discontinuous effluent streams. The number of such operations is highly dependent on the maintenance management. This effluent is typically directed to a central waste water treatment facility. Table 11.9 shows the pollutant load of a combined waste water stream (process water and cooling water) from an acrylonitrile plant both before and after treatment in a central WWTP.

Pollutant	Pre-treatment pollutant load (kg/tonne of Acrylonitrile)	% removal in central WWTP	Emission factor (kg/tonne of Acrylonitrile)
COD	32	93	2.24
Kjeldahl-N	3.0	95	0.15
Cyanide	0.10	≥99	-
Acrylonitrile	0.049	≥99	-
Sulphate	0.003	3 % to waste water sludge	-
Molybdenum	0.005	3 - 4 % to waste water sludge	-

Note: Acrylonitrile plant has an annual capacity of 190 kt.

Table 11.9: 1999 water arisings and emissions from an acrylonitrile plant in The Netherlands [InfoMil, 2000 #83]

11.3.4 Co-products and wastes

Hydrogen cyanide co-product. Hydrogen cyanide is produced in the acrylonitrile reactors and may be recovered as the overhead product from the first column of the purification train. The catalyst used in the acrylonitrile reactors dictates the amount of hydrogen cyanide produced and it can range from 90 to 120 kg hydrogen cyanide / tonne of acrylonitrile production [CEFIC, 2000 #107]. The hydrogen cyanide is either sold or converted on-site to other products.

Acetonitrile co-product. Acetonitrile is produced in the acrylonitrile reactors and is separated as an overhead product from the stripper column. Crude acetonitrile is produced in the range 5 to 32 kg/t acrylonitrile. The rate is determined by the catalyst used in the acrylonitrile reactors [CEFIC, 2000 #107]. Hydrogen cyanide is also present in this stream at a rate of 0.1 to 0.3 kg/t acrylonitrile [CEFIC, 2000 #107].

Ammonium sulphate co-product. Ammonium sulphate is produced in the quench area of the process at the rate of 115 to 200 kg/t acrylonitrile [CEFIC, 2000 #107].

Entrained acrylonitrile catalyst waste. The ammoxidation reaction takes place in fluid bed reactors and the catalyst is retained in the reactors using combinations of cyclones. The cyclones are not 100 % efficient and some catalyst is lost from the reactors and exits the process through the quench system. The rate of catalyst loss is in the range 0.3 to 0.7 kg/t acrylonitrile, but may be greater in the case of upset conditions (e.g. loss of cyclone efficiency, plugging of dip legs or of distribution spargers) [CEFIC, 2000 #107]. Spent catalyst has the same composition as virgin catalyst (i.e. metal oxides on a silica support).

Table 11.10 shows actual waste streams (prior to treatment) from an acrylonitrile plant.

Type of hazardous waste	Emission factor (kg/tonne of acrylonitrile)	Destination
Acrylonitrile catalyst	0.4	Small part recycled, most of it to ammonium sulphate plant
ZA oil (organic and inorganic contaminants from crystalliser)	70 - 80 *	Incinerator and sulphur recovery
Small scale hazardous waste	0.34	Partly incinerated, partly recycled, partly waste storage
Water/oil slurry and sludge	0.65	Incineration after dewatering
* Not exactly known, part of it comes from another plant		

Table 11.10: 1999 waste arisings from an acrylonitrile plant in The Netherlands [InfoMil, 2000 #83]

11.3.5 Example plants

The collection of this information has not been co-ordinated according to any pan-European protocol although there may have been protocols at Member State level. The data are presented in a variety of formats and should be seen as real-life examples of plant performance. Accurate interpretation of the data may require further information from the originating Member State.

	Plant 11 Internal No. B5 (capacity 240 kt/yr acrylonitrile)
Waste gas	Maximum emission concentrations as 1/2 h - average: NH ₃ max. 1 mg/m ³ . CO max. 10 mg/m ³ . NO ₂ max. 374 mg/m ³ . Oxygen organics max 900 mg/m ³ . Many different diffuse emission sources
Waste water	<u>Raw data.</u> stream 1 to final treatment: TOC 1800 mg/l (50 m ³ /h) stream 2 to final treatment: NH ₃ -N 240 mg/l (5 m ³ /h) stream 3 to incineration: TOC 550000 mg/l (11.5 m ³ /h) <u>Emissions:</u> stream 1: 3.3 kg TOC/t acrylonitrile stream 2: 0.04 kg NH ₃ /t acrylonitrile stream 3: 230 kg TOC/t Acrylonitrile
Solid wastes	69 tpa used catalyst with Mo, Bi, Co, Cr, Ni (Recycling) 150 tpa organic distillation residuals (combustion) 100 tpa sludges from petrochemical processes (combustion)
Energy	Exothermic reaction - 56 t/h of 30 bar steam and 3 t/h of 5 bar steam are sent to other facilities. Consumption of electricity 2.7 MW

Table 11.11: Emission / consumption data for a German acrylonitrile plant) [UBA (Germany), 2000 #91]

11.4 Techniques to consider in the determination of BAT

11.4.1 Process design

11.4.1.1 Process route

Compared with its predecessors the acrylonitrile production process based on the ammoxidation of propylene is cheaper, allows large units to be built (more than 100 kt/yr) and has better environmental performance. All acrylonitrile plants in the EU now use the propylene ammoxidation process in a fluidised bed reactor known as the 'BP-Sohio Process'. Recently, Monsanto-Solutia has licensed its own process, similar to the 'BP-Sohio Process'.

Pure air, or air slightly enriched with oxygen can be used in the reaction. Enriched air allows a larger output in a given reactor volume, and is often used as a de-bottlenecking technique, but its environmental benefit (off-gas volume reduction) is marginal.

11.4.1.2 Co-products recovery

Pure hydrogen cyanide is recovered from the process, ideally for re-use and/or sale, but this depends on market demand. Even where markets exist, facilities must be provided to enable the continuous burning of all hydrogen cyanide that is recovered.

Acetonitrile can be purified to a commercial grade product. Purification needs investment and energy, and is only justified when a profitable market exists; otherwise, unpurified acetonitrile will be burnt as fuel.

Excess ammonia, which is unconverted in the reaction, is reacted with sulphuric acid, producing an ammonium sulphate solution that can be sold as fertiliser. Crystallisation is the only way to obtain solid reusable ammonium sulphate. The ammonium sulphate recovery section also includes facilities to allow the removal of organics and catalyst fines. Alternatively, the ammonium sulphate can be converted into sulphuric acid in a dedicated unit.

11.4.1.3 Storage and loading facilities

Owing to the hazardous properties of acrylonitrile and hydrogen cyanide, safety considerations are very important in their storage and handling. Acrylonitrile has the ability to self-polymerise if initiators are present and is flammable. Stabilising agents may therefore be added to the product, and measures taken to prevent the accidental ingress of impurities that could either strongly react or catalyse a runaway reaction.

Acrylonitrile is typically stored in tanks under nitrogen at atmospheric pressure. Care is taken to cope with the flammable properties of acrylonitrile. Also, a minimum amount of oxygen has to be present in the solution to ensure acrylonitrile stability. Tank vents are typically routed to water scrubbers that ensure very low acrylonitrile emissions to air.

Systems for loading acrylonitrile into trucks or railcars are typically equipped with vapour return systems in order to minimise the releases, or pass to an appropriate treatment technique (e.g. water scrubbing). Emissions of acrylonitrile during loading operations are minimised by properly purging relevant piping and coupling connections before decoupling. Purge vents are subsequently sent to a vapour return system or treated.

Pure hydrogen cyanide is not stored in large volumes, but a small volume buffer tank is typically used to aid its continuous re-use or destruction. When hydrogen cyanide is sold, storage capacity is minimised, consistent with shipping requirements.

11.4.1.4 Raw materials consumption

By far the most important factor causing raw material consumption to be higher than stoichiometric is the limited activity and selectivity of the acrylonitrile catalyst. Significant progress has been made in reducing raw material losses through catalyst performance and further efforts are continuing, mainly driven by economic factors. The selection of the catalyst is intended to maximise the output of saleable acrylonitrile, but also of hydrogen cyanide and acetonitrile. Once the catalyst is selected, the reaction is monitored carefully to:

- (i) optimise the yields, adjusting the temperature, the proportion of reactants and particularly the oxygen content
- (ii) to maintain the high yields through frequent (even continuous) reaction gas analysis
- (iii) to protect the catalysts against process upsets through measures like automatic shutdown and reliable interlock systems.

The reaction performances also depend on the efficacy of fluidisation since poor fluidisation leads to high-temperature spots where propylene is combusted. Some of the important factors to consider are: the gas distribution; the proper design / maintenance of cyclones and dip legs; the operating instructions; facilities to avoid sparger plugging at shutdown or to blow the dip legs in case of plugging; catalyst consumption, and the monitoring of temperatures.

Raw materials loss also is reduced by a properly designed acrylonitrile recovery system downstream of reaction and the selection of optimum conditions throughout the plant (i.e. pH, temperatures, nature, concentration and method of injection of inhibitors) to avoid side reactions or degradation of the desired products.

Losses of valuable products with the organic wastes or the aqueous effluents can be minimised by optimisation of the recovery conditions, but these represent a minor amount compared to the other loss factors mentioned above.

Pure hydrogen cyanide is obtained in all acrylonitrile units as part of the standard design. It is desirable to upgrade the hydrogen cyanide, often into acetone cyanohydrin that can be used as a chemical feedstock. As hydrogen cyanide storage is undesirable, the aim is to maximise the reliability of the downstream processes, and to control the hydrogen cyanide distillation process to maintain hydrogen cyanide quality.

Pure acetonitrile can be obtained as a by-product but it requires a dedicated recovery system. As only small quantities of acetonitrile are co-produced (depending on catalyst type), acetonitrile recovery is not profitable for all producers. The options are either to burn the acetonitrile, sometimes with the absorber off-gas, or to purify it.

11.4.1.5 Utilities consumption

The use of electricity and steam represents a significant share of the production cost of acrylonitrile. Raw water may be a source of significant environmental problems (particularly in hot, dry locations) and its consumption is a consequence of process and energy management choices.

The acrylonitrile catalyst selectivity and the heat balance are linked. An efficient catalyst has a high propylene conversion into valuable products, and a low propylene combustion. The more efficient the catalyst is, the less steam is produced at the reaction and in the heat recovery section downstream of the reactor. The plant energy balance also depends on local factors like the presence of acetonitrile or ammonium sulphate recovery units, but acrylonitrile units are generally net steam exporters.

The re-use of this energy in the complex is a key issue and a proper energy management system at site level is an essential tool to ensure high performance of an acrylonitrile unit. High-pressure steam (at more than 30 bar) is generated at the reaction step and is either sent to turbine driven air compressors, or used to produce electricity outside of the acrylonitrile unit, or exported as steam to a site network.

The steam consumptions inside the core acrylonitrile plant are mainly for distillation. The steam consumption of new distillation columns can be optimised using standard design methods. Existing columns can use re-traying and re-packing techniques, but the reduced steam consumption is often secondary to de-bottlenecking of the plant capacity.

The major power consumers of an acrylonitrile unit are the air compressors. The usual ways to reduce the energy consumption of compressors are applicable (i.e. efficient design, or reduction of pressure drops) and some minor improvements can also be obtained through the use of gas seals. Especially in hot climates, significant electric power is consumed in refrigeration units necessary to condense and cool hydrogen cyanide.

11.4.2 Air emissions

The Flemish region of Belgium has legislation requiring the incineration of waste gas from the reactor and absorber, and the incinerator off-gas is subject to an acrylonitrile emission limit value of 0.2 mg/m³. Waste gases from reactor product distillation and from filling operations are required to be scrubbed in order to meet the 'general' (not sector specific) acrylonitrile ELV of 5 mg/Nm³ (for mass flows of at least 25 g/h) [VITO, 1999 #53].

The Netherlands similarly has a special regulation (3.5/29.3a) relating to the production of acrylonitrile. This requires that waste gases from the absorber and reactor should be fed to a boiler or incinerator, and the concentration of acrylonitrile in the exhaust gas may not exceed 0.5 mg/Nm³ (the detection limit for very good analysis techniques). The emissions from the distillation of reaction products and emissions released by displacement losses in the storage of (intermediate) products should comply with the general emission standards of the NeR (5 mg acrylonitrile /Nm³ if the raw gas stream contains 25 g acrylonitrile /h or more).

German reference documents (VDI 3862, Blt. I of 4/87 and Blt. II of 2/91) set minimum detection limits for the analysis of acrylonitrile. With FID the detection limit is 0.5 or 0.3 mg/m³ (dependent on the type of sampling). With PND (phosphorus nitrogen selective detectors) the detection limit is 0.05 mg/m³.

11.4.2.1 Absorber vent off-gas

The reaction off-gases in the stream leaving the process absorber contain non-condensable components (nitrogen, oxygen, carbon monoxide, carbon dioxide, propylene, propane, and argon) as well as vaporised water and traces of organic contaminants. In some cases, the acetonitrile produced at the reaction is entrained in this stream.

The volume of the stream can be reduced by the use of enriched air, instead of normal air for the reactions, but this may not always be economically viable. The off-gas stream can also be reduced by improved catalyst efficiency.

Thermal or catalytic oxidation can be used to treat this stream, leading to almost total destruction of organic pollutants (99.9 % destruction is quoted in [InfoMil, 2000 #83] and CEFIC have, by convention, assumed 100 % destruction efficiency). Usually a heat recovery unit (steam generation) is associated with the oxidiser. The high destruction temperature of

acrylonitrile, however, may necessitate a support fuel especially if the tank is nitrogen blanketed instead of atmospheric [Environment Agency (E&W), 1999 #7].

Autothermal incineration, dispensing with the need for support fuel, is also under consideration on one plant and was expected to cost under £10 million but an alternative technology will be implemented [ENDS Report, June 2000 #119].

11.4.2.2 Residues incineration

An acrylonitrile plant may have facilities to incinerate process residues and also to burn hydrogen cyanide. Such facilities will generate combustion flue gases. The magnitude and composition of flue gases will depend on the use of external facilities and the availability of hydrogen cyanide consumers.

Techniques to minimise this stream include reducing the formation of residues at the reaction step (through reaction monitoring) and ensuring proper operating conditions (to reduce the loss of valuable products in the residue streams and to avoid degradation of valuable products throughout the unit).

There is usually no specific treatment of the flue gas (except for heat recovery), except when catalyst fines are present in a residue and then an electrostatic precipitator is usually used to collect particulates.

11.4.2.3 Storage tanks

The release of acrylonitrile to atmosphere during storage can be significant and storage tanks must be vented to a safe location. In order to protect against possible polymerisation reactions occurring during storage, small quantities of inhibitors are added. One of these, MEHQ (monomethyl ether of hydroquinone) requires small quantities of dissolved oxygen in order to be effective. Tank breathing losses are often minimised by a suitable method (e.g. an internal floating roof structure for storage tanks) followed by scrubbing.

Detailed guidance on the storage and handling of acrylonitrile can be found in a regularly updated note that is widely used within the industrial sector [CEFIC - Acrylonitrile Sector Group, 1995 #145]. The note can be accessed from the CEFIC website (<http://www.cefic.org>). Key points of the note are:

- Storage tanks should be the smallest compatible with shipping and receiving requirements. Storage times in excess six months should be avoided to minimise degradation of acrylonitrile quality.
- Acrylonitrile storage tanks do not require insulation or refrigeration. White paint should be considered for outside storage tank exterior surface in hot climates, to minimise temperature rise.
- Agitation of storage tanks on production units is recommended both for uniformity of sampling and for the addition of inhibitors. Agitation is best achieved by pumping a recirculating stream through eductors maintained near the bottom of the tank.
- Acrylonitrile should be stored under a nitrogen blanket in order to avoid explosive vapour mixtures.
- For prolonged storage periods of AN, it is recommended that the oxygen concentration is monitored to ensure that the inhibitors remain effective.
- Acrylonitrile must be handled in a closed system. This can be achieved by using vapour return lines when loading or unloading. In the absence of a vapour return system, the displaced vapours in the tank must then be routed to a vapour treatment unit.

11.4.2.4 Miscellaneous vent streams

There are a number of other diverse origins for vents, including: process vessels, loading facilities, process analysers, sampling connections, safety valves and maintenance vents. The vents usually contain valuable products (acrylonitrile, hydrogen cyanide or acetonitrile) diluted by non-condensable gases (propylene, carbon dioxide, nitrogen, oxygen). Some of the techniques to minimise these streams include:

- vapour phase equilibrium during transfer and loading operations
- closed sampling systems
- proper operating procedures to clean the unit prior to maintenance.

The vents are usually treated in water scrubbers. When large quantities of propane or propylene are likely to be present, the stream may be flared.

11.4.2.5 Fugitive emissions

Fugitive emissions from acrylonitrile processes are generally low because the process pressure is moderate. Fugitives will mainly consist of acrylonitrile, hydrogen cyanide, acetonitrile, propylene and propane. Due to their toxic nature, the permitted limit values for acrylonitrile and hydrogen cyanide in ambient air are very low (2ppm and 10ppm respectively in most of Europe). For occupational health reasons, and with consequential environmental benefit, extensive measures have been taken to prevent releases, and to detect them at an early stage such that remedial measures can be taken promptly. Prevention techniques are described in Section 5.3.1.3.

11.4.3 Water emissions

The acrylonitrile process produces water in the reaction step and the rejection of water from the process is a critical part in the design of all acrylonitrile plants. Many differing techniques are used depending upon the individual circumstances and location of the production unit. Key steps normally involve concentrating the contaminant in the water stream using evaporation (either single or multiple effect). The concentrated contaminated stream is handled in a number of different ways depending on the design of the plant, these include burning the stream or recycling to other parts of the process to maximise recovery of saleable products before burning the contaminated stream. The 'clean' water stream recovered from these concentration processes is further treated, normally, in biological waste water treatment plants prior to discharge to water bodies. The biological treatment units can either be a central site facility or specific to the acrylonitrile plant.

There are also reports of wet air oxidation of waste water from the waste water stripping column, followed by ammonium sulphate recovery; and also powdered activated carbon treatment of acrylonitrile stripping and treated waste water stripping column effluents [Environment Agency (E&W), 1999 #7]. Waste water columns are also reported for the removal of hydrogen cyanide and acrylonitrile [InfoMil, 2000 #83]

The removal efficiency of a central waste water treatment plant treating acrylonitrile effluents has been reported as [InfoMil, 2000 #83]:

COD: 93 %	Acrylonitrile ≥ 99 %
K _J -N: 95 %	SO ₄ ²⁻ : 3 % to waste water sludge
CN ⁻ : ≥ 99 %	Mo: 3 – 4 % to waste water sludge

At the BASF site on Teesside, England a liquid waste gasification unit is being built to treat process liquid effluent streams from a number of different processes, including an acrylonitrile plant. The unit has a capital cost of £16 million. The gasifier will operate at a pressure of 29 bar and a temperature of 1200 - 1400 °C, and will deal with 13 tonnes of waste per hour. The reducing atmosphere of the reactor will produce a syngas of 35 % hydrogen and 27 % carbon monoxide along with carbon dioxide and nitrogen. The gasifier exhaust gas will be cooled and cleaned and passed to two-stage heat recovery. The cleaned syngas will be combusted in existing boilers and the effluent discharged. The unit is expected to significantly reduce the discharge of COD and ammonia to the River Tees, as well as emissions of nitrogen oxides, sulphur oxides and particulates to air. Energy consumption will also reduce. The technology could have interest to other processes that combust organic wastes with a high nitrogenous content [ENDS Report, June 2000 #119].

11.4.4 Solid wastes

The fluidised catalyst undergoes attrition, creating fines, and they cannot all be captured by the reactor cyclones. The fines are entrained outside of the reactor and are collected in the quench system. The arising of catalyst fines can be minimised by selecting a catalyst that is resistant to attrition. Further attention should be paid to the proper monitoring of reaction temperature, and frequent assessment of the amount of recovered fines as these are good measures of reactor operation.

Whatever the quench technique, the spent catalyst is recovered from an aqueous liquid phase where it is separated by settling and/or filtration. Recovered spent catalyst is usually burnt or disposed of to licensed landfill. The condition of the recovered catalyst makes it unsuitable for re-use in the reactors, but in certain circumstances the recovered catalyst can be treated for metals recovery.

11.4.5 Liquid residues

Heavy residues are recovered from the quench system (catalyst fines and heavy organics) and from the bottom of stripper columns (heavy organic compounds / polymers). The arisings can be minimised by such techniques as:

- reduce the formation of fines and catalyst losses
- avoid degradation of products by using mild operating conditions and addition of stabilisers
- maximise the recovery of valuable product from waste streams
- selection of catalyst.

The heavy residue streams can be first concentrated and then incinerated (either on-site or off-site), preferably with heat recovery.

When **hydrogen cyanide** co-product cannot be re-used or sold, it has to be continually destroyed to avoid storage. The destruction method is either flaring in a dedicated flare, or burning in a local incinerator. Where a plant has no outlet to re-use hydrogen cyanide the stream can be minimised, to a certain extent, by the optimisation of reaction conditions. Where there is a hydrogen cyanide re-use unit, the residue stream is minimised by ensuring a constant distilled hydrogen cyanide quality and ensuring the reliability of the hydrogen cyanide downstream re-use unit.

When **acetonitrile** by-product cannot be sold for any reason, then crude acetonitrile is normally incinerated with energy recovery. The acetonitrile may also be routed with the absorber off-gas, but this provision must be included at the design stage.

11.5 Best Available Techniques

As explained in Chapter 6, BAT for a particular LVOC process is determined by considering the three levels of BAT in the following order of precedence: illustrative process BAT (where it exists); LVOC Generic BAT; and finally any relevant Horizontal BAT. The following techniques are BAT for the illustrative process of acrylonitrile production.

11.5.1 Process selection

The old acrylonitrile production process based on the addition of hydrogen cyanide to acetylene is no longer practised and is not BAT. The BAT process is based on the ammoxidation of propylene in a fluid bed reactor, with subsequent recovery of acrylonitrile. Recovery for sale of the main co-products, hydrogen cyanide, acetonitrile, and ammonium sulphate may be BAT depending on local circumstances. The BAT process may also make a choice between atmospheric air and oxygen-enriched air, and between chemical-grade and polymerisation-grade propylene feedstock.

11.5.2 Plant design

BAT for acetonitrile is to recover and purify it when a market is available, or to burn it with heat recovery (current world market of acetonitrile is significantly smaller than its production during acrylonitrile manufacture).

Regardless of the presence of reliable downstream sinks, BAT for the pure, recovered hydrogen cyanide is to

- re-use hydrogen cyanide on-site or to sell
- provide adequately sized flare and/or incineration facilities to destroy hydrogen cyanide when it cannot be re-used
- minimise the amount and duration of hydrogen cyanide storage (consistent with requirements of any downstream process or transportation).

BAT for the ammonium sulphate resulting from the neutralisation of excess ammonia is either crystallisation and sale to the fertilisers industry, or treatment in a dedicated unit where sulphuric acid is regenerated.

BAT for vent streams from normal operation that contain organics is:

- Firstly; minimisation by, *inter alia*, vapour phase equilibrium during transfer and loading operations, closed sampling systems and proper operating procedures to clean the unit prior to maintenance.
- And subsequently, connection to a recovery system, or to a vent gas treatment system (e.g. incinerator, thermal oxidiser, flare or scrubber). Emergency relief vents that, due to their large flow, would overload the pollution control equipment are not limited to the same emission limits as routine venting.

For BAT concerning storage and loading facilities reference is made to Section 6.3. Because of the hazardous nature of acrylonitrile and hydrogen cyanide, the following specific BAT measures are required in the design of storage and loading facilities for acrylonitrile production:

- avoid the ingress of impurities likely to react dangerously with acrylonitrile
- avoid the risks of fire in the gaseous phase of tanks and in shipping by considering the flammability of acrylonitrile, hydrogen cyanide, acetonitrile and any stored intermediate streams in the design of barges, road tankers or railcars used to transport these products (e.g. nitrogen blanketing)

- minimise the amount and duration of hydrogen cyanide storage (consistent with requirements of any downstream process or transportation) and monitor for temperature, inhibitors and colour on any stored material
- bund storage facilities to prevent soil and water pollution in the event of spillage
- equip the acrylonitrile, acetonitrile and hydrogen cyanide (rail cars only) loading systems for trucks or railcars with a vapour return system to minimise the gaseous vents that require further treatment in an appropriate system (e.g. a water scrubber).

11.5.3 Air emissions

The following vent streams have to be considered:

- absorber off-gas
- flue gas from process waste oxidation
- miscellaneous vent streams
- fugitive emissions.

BAT for the adsorber off-gas is minimisation followed by treatment:

Minimisation of adsorber off-gas volume and pollutant load:

- The priority consists in reducing the amount of the absorber off-gas per tonne of acrylonitrile by means of a more efficient catalyst and optimised reaction/operation conditions. The use of enriched air and/or of polymerisation grade propylene complies with this prerequisite, but must be judged after a full cost/benefit analysis (i.e. including the costs/benefits of oxygen generation). Although oxygen enrichment of the reaction air can reduce the off-gas volume, air-based and enriched-air based processes are both BAT.
- Catalysts are selected to maximise the yield of valuable products (i.e. acrylonitrile, hydrogen cyanide and acetonitrile) and minimise waste production. Where acrylonitrile is the sole product, then the BAT choice of catalyst can give a yield of >75 % (acrylonitrile).

Treatment of adsorber off-gas:

- BAT for the remaining absorber off-gas is destruction of the organics in a dedicated thermal or catalytic oxidiser, or in a common purpose incinerator or in a boiler plant. In all cases, BAT will include heat recovery (normally steam production).

BAT for the miscellaneous vent streams is treatment in either the absorber off-gas treatment system or a common flare system for total destruction of the organics. Other vent streams may be treated by other techniques, such as scrubbing, which will allow the recycling of the recovered components.

The performance of the vent stream treatment systems should target acrylonitrile concentrations (as hourly averages) of 0.5 mg/Nm^3 (the detection limit in vents) for oxidation systems and 5 mg/Nm^3 for scrubbing systems.

BAT for fugitive emissions is concomitant with minimising operator exposure to acrylonitrile. This is demonstrated by observing threshold limits in ambient air of less than 2 ppm acrylonitrile for an 8 hours/day exposure. The measures to minimise fugitive emissions are covered generically in Section 6.3.

11.5.4 Water emissions

Contaminated aqueous effluent streams include:

- effluent from the quench section (containing ammonium sulphate)
- stripper bottoms stream
- discontinuous streams (e.g. cleaning water prior to maintenance operation).

BAT includes either the crystallisation of ammonium sulphate for sale as fertilisers, or its treatment in a dedicated unit for sulphuric acid regeneration.

BAT for the water streams is pre-treatment by distillation to reduce the light hydrocarbons content and to concentrate or separate heavy hydrocarbons, with the aim of reducing the organics load prior to final treatment. BAT for the recovered light and heavy hydrocarbon streams is further treatment to recover useful components (e.g. acetonitrile) prior to combustion with energy recovery.

BAT consists in transferring the contaminated effluent stream to a dedicated, central or external waste water treatment plant including biotreatment, to take advantage of the high biodegradability of the organic contaminants. When biotreatment facilities are not available at a location equivalent quality effluent can be produced using distillation techniques. The application of BAT allows an emission level of 0.4 kg Total Organic Carbon /t acrylonitrile to be achieved (based on an organics destruction rate of 90 %).

11.5.5 By-products and wastes

BAT is to maximise the re-use of hydrogen cyanide, acetonitrile and ammonium sulphate by-products, although local circumstances and markets may, at times, prevent this.

Where the pure hydrogen cyanide cannot be recovered for any reason, then BAT is destruction in a flare or incinerator that has a capacity for all the hydrogen cyanide production (even when a reliable downstream re-use unit exists).

When provided for at design step, BAT for the crude acetonitrile is recovery from the core unit, for further purification. Otherwise BAT for acetonitrile is burning the crude liquid acetonitrile stream (with energy recovery), or by mixing the crude acetonitrile with the absorber vent stream for burning (with energy recovery).

BAT for ammonium sulphate is recovery as crystal, or, where recovery is not possible, conversion to sulphuric acid.

BAT for the catalyst fines is separation by settling or filtration, and treatment by combustion or landfill disposal.

BAT for heavy residues is firstly minimisation by:

- reducing the formation of fines and catalyst losses
- avoiding degradation of products by using mild operating conditions and addition of stabilisers
- maximising the recovery of valuable product from waste streams
- selection of catalyst.

BAT for the heavy residues that cannot be avoided by minimisation techniques is recovery from the stripper column bottoms and/or from the quench system (basic quench) together with the catalyst fines, followed by on-site or off-site incineration.

11.6 Emerging techniques

Recent announcements have described a new development in acrylonitrile manufacturing where propane is used as the C₃ source instead of propylene. This process has only been demonstrated at pilot plant scale and no experience is available in commercial scale plants [CEFIC, 2000 #86]. Despite the cost advantage of propane over propylene, there is unlikely to be a change in the near future [Ullmann, 1998 #80].

Developments in C₁ chemistry are reported to offer a new, two-step route to acrylonitrile [Weissermel & Arpe, 1993 #59]. Synthesis gas is first reacted with ammonia at 350 - 600 °C and pressure up to 35 bar to produce acetonitrile that is then converted to acrylonitrile in an oxidative methylation with methane. The acetonitrile by-product from the ammoxidation of propene could be also converted to acrylonitrile by this route.

High conversions to acrylonitrile have been also obtained on a laboratory scale from ethylene, hydrogen cyanide and oxygen using a palladium-based catalyst [Ullmann, 1998 #80].

12 ILLUSTRATIVE PROCESS: ETHYLENE DICHLORIDE / VINYL CHLORIDE MONOMER

Since the majority of 1,2 ethylene dichloride (EDC) is used to produce Vinyl Chloride Monomer (VCM), and there is a high degree of integration between these two illustrative processes, they are logically considered together in this chapter.

12.1 General information

EDC is mainly used for the production of VCM, and VCM is itself used almost exclusively in the manufacture of the commercially important plastic Polyvinyl Chloride (PVC) and the associated homo-polymers / co-polymers. There is some very minor use of VCM in chlorinated solvent manufacture, and a little EDC is used for ethylene diamine production. The EDC/VCM process is often integrated with chlorine production sites because of the issues with chlorine transportation and because the EDC/VCM/PVC chain is the largest single chlorine consumer.

Production capacity. The European Council of Vinyl Manufacturers (ECVM) represents 90 % of the European production of EDC/VCM, and the location of their production sites are shown in Table 12.1.

Country	Location	N° of EDC and /or VCM production sites	VCM nameplate capacity (kt/yr)
Belgium	Antwerp	2*	990
	Jemeppe	1	
	Tessengerlo	1	
France	Fos sur Mer	1	1140
	Jarrie	1*	
	Lavera	1	
	Tavaux	1	
Germany	Burghausen	1	1740
	Gendorf	1	
	Hurth	1	
	Ludwigshafen	1	
	Luelsdorf	1*	
	Marl	1	
	Rheinberg	1	
	Schkopau	1	
	Stade	1*	
	Wilhelmshaven	1	
Italy **	Porto Marghera	1	450
	Porto Torres	1	
	Ravenna	1	
Netherlands	Botlek	1	520
Spain	Martorell	1	420
	Palos de Moguer	1*	
	Tarragona	1	
Sweden	Stenungsund	1	120
UK	Runcorn	2*	230
	Wilton	1*	
Total EU*		30	5610
Norway	Rafnes	1	470
Total Western Europe		31	5910
* The figure relates to, or includes, one stand-alone EDC unit.			
** Brindisi (Italy) plant was closed in early 2000.			

Table 12.1: Location of EDC/VCM plants in Western Europe [CEFIC, 1999 #68]

In 1997 VCM production in Western Europe was 5500 Kt, and the growth over the 1993 - 97 period was 1.2 % per year. Assuming that nearly all EDC is converted into VCM, this equates to an annual West European EDC production of 9400 Kt [CEFIC, 1999 #68].

The world production of VCM in 1997 was 24000 Kt; of which 30 % was produced in the USA and 30 % in Asia. Since the 1998 VCM production capacity was estimated at 30000 Kt, this implies some 80 % of capacity utilisation [CEFIC, 1999 #68].

EDC, VCM and PVC are all relatively easy to transport and, because this creates a global market, the balance between internal use and export is constantly changing. The EDC/VCM market is therefore characterised by a high variability in selling price. The total costs of EDC/VCM will vary with that of both ethylene and chlorine, and this suggests a partial decoupling from the petrochemical business cycle.

The historical trend of cash cost margins for EDC and VCM are shown in Figure 12.1. Although the shapes of the curves are a little different to those of basic petrochemicals and polyolefins, the message is similar i.e. that these are commodity products in which cost increases cannot necessarily be passed on to consumers. There is a range of economics between plants, and the business situation for those at the poor end is not attractive in times of down turn.

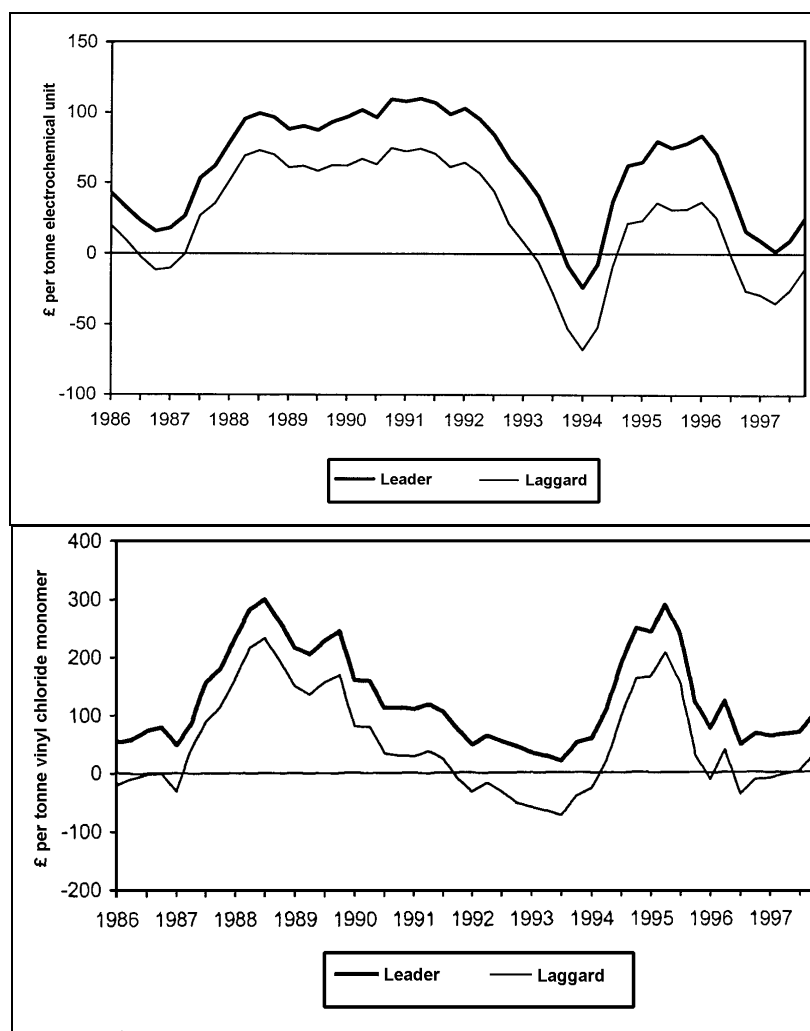

Figure 12.1: Cash cost margins for EDC and VCM in Western Europe [Environment Agency (E&W), 1998 #1]

The differences between leader and laggard costs of production are an indicator of the potential margin for more economic producers. These are given in Table 12.2.

Product	Leader (£/t)	Laggard (£/t)	Difference (£/t)
EDC	157	219	62
VCM	264	311	47

Table 12.2: Leader and laggard Cash Costs for EDC/VCM (Western Europe in 1997) [Environment Agency (E&W), 1998 #1]

EDC/VCM units generally have large capacities and are highly automated. A modern VCM unit is typically controlled by 8 operators per shift, and the number of direct jobs in EDC/VCM production in the EU is within the range 4000 to 6000.

Table 12.3 gives the typical raw material consumption and unit costs for a new world-scale plant producing 400 kt/yr VCM in a 'balanced' unit (i.e. no import or export of EDC or HCl). If VCM is sold at 410 €/t and production costs amount to 347 €/t, then this plant would generate a margin of 25.2 M€/year which should be compared to an investment cost of 250 M Euro [CEFIC, 1999 #68].

Component	Usage	Unit cost	Total cost (€/t VCM)
Ethylene	0.47 t	400 €/t	188
Chlorine	0.60 t	120 €/t	72
Oxygen	0.14 t	40 €/t (Note 1)	5.6
Electricity	0.2 MWh	39 €/MWh (Note 2)	7.8
Natural gas	1 MWh	13 €/MWh	13.0
Steam	0.2 t	9 €/t	1.8
Effluent treatment		10 €/t	10
Auxiliary products/utilities		10 €/t VCM	10.0
Manpower		2.5 M€/year	6.3
Maintenance		8 M€/year (Note 3)	20
Plant overheads		5 M€/year (Note 4)	12.5
			Total 347
Note 1: Oxygen fed from an external source could be more expensive			
Note 2: Excluding electricity consumption for oxygen production			
Note 3: Based on proportional capital assets			
Note 4: Including all plant services			

Table 12.3: Typical Cost Breakdown for a 400 kt/yr VCM plant [CEFIC, 1999 #68]

12.2 Applied processes and techniques

Up to the 1960s, VCM was essentially produced by the gas-phase hydrochlorination of acetylene with hydrochloric acid (HCl) over a mercuric chloride based catalyst. But due to the high cost of acetylene, and the emergence of large steam-crackers providing abundant ethylene, the ethylene route has replaced acetylene. The process is not used in the EU and is only possibly economic where inexpensive coal can be used to produce carbide-based acetylene [Weissermel & Arpe, 1993 #59].

In the ethylene-based process, EDC is synthesised by the chlorination of ethylene (direct chlorination) or by the chlorination of ethylene with HCl and oxygen (oxychlorination). Thermal cracking of dry, pure EDC then produces VCM and HCl. When all the HCl generated in EDC cracking is re-used in an oxychlorination section, and when no EDC or HCl is imported or exported, then the VCM unit is called a 'balanced unit' (see Figure 12.2). By using both

direct chlorination and oxychlorination for EDC production, balanced units achieve a high level of by-product utilisation. The reactions are represented by the formulae:

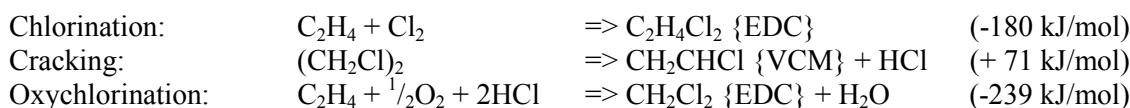

12.2.1 Raw materials

In a balanced unit the only raw material requirements are ethylene and chlorine and these are generally supplied by pipeline from nearby production facilities. Ethylene typically comes from a standard steam cracker, but the propane/propene content must be controlled to minimise the formation of chloropropanes and chloropropenes [Ullmann, 1998 #80]. Dry, compressed chlorine is required and, depending on site specific factors, this may derive from cell-room tail gas (containing O₂, N₂, and CO₂ inerts) or may be re-vaporised from liquid chlorine. The choice will depend upon the operational basis of the chlor-alkali and the VCM plant. The bromine content of the chlorine feed should be as low as possible in order to minimise the downstream formation of brominated by-products. The inerts contained in tail gas chlorine may create downstream emission issues.

An unbalanced unit will have the same ethylene and chlorine requirements, but may also need to import or export gaseous hydrochloric acid and EDC. HCl can be provided by an external source (such as recovery from an organic chlorination unit, or isocyanate production) or can be used to produce commercial grade acid. EDC can be readily shipped in, but care needs to be taken with its purity as this affects the quantity and composition of light and heavy residues, and will also affect the rate of coke build-up in the cracking unit.

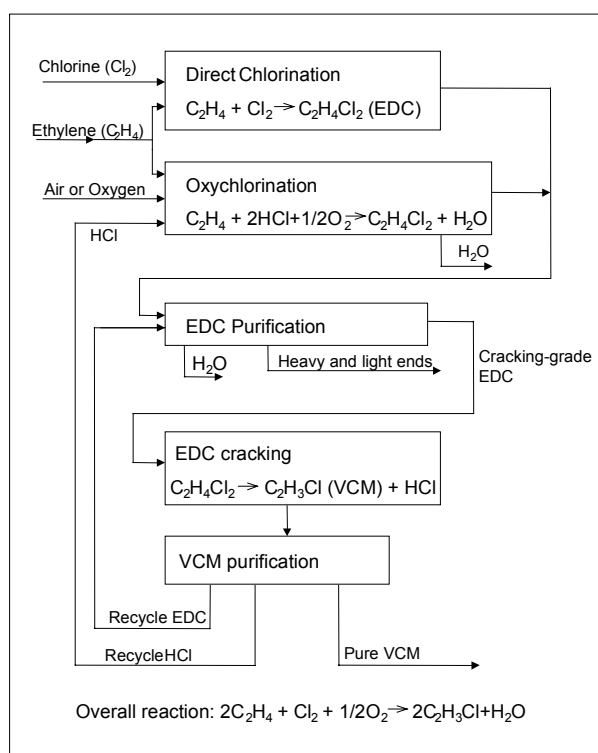

Figure 12.2: Balanced production of EDC and VCM [CEFIC, 1999 #68]

12.2.2 Direct chlorination

In direct chlorination EDC is synthesised by the exothermic reaction of ethylene and chlorine, generally in the liquid phase using the EDC product as the reaction medium. The operating temperatures are normally 50 - 120 °C and the pressure range from atmospheric to 5 bar. The reaction may be run with a slight excess of ethylene or chlorine depending on the variant of the direct chlorination reaction process. The reaction is catalysed by metal chlorides, typically ferric chloride, but aluminium, copper and antimony chlorides may also be used. The reaction product consists of more than 99 % EDC and less than 1 % other chlorinated hydrocarbons (predominantly 1,1,2 trichloroethane and ethyl chloride). Oxygen, or maybe dimethyl formamide, inhibitor may be added to reduce the formation of chlorinated by-products (especially 1,1,2-trichloroethane) by substitution reactions. Two variants of the direct chlorination reaction are currently used:

- **‘Low temperature chlorination’** in which the reaction is operated below the EDC boiling point (less than 70 °C). The liquid EDC leaving the reactor must generally be washed to eliminate the catalyst, thus leading to wet EDC (that requires drying and distillation before cracking), and to a liquid effluent (that requires treatment). This route produces slightly less by-product than high temperature chlorination and allows the use of lower-grade construction materials, but it has high energy requirements because of the EDC distillation. It was historically the first production route and is still the commonest route in Europe
- **‘High temperature chlorination’** in which the reaction is operated above the EDC boiling point (more than 90 °C). The EDC leaves the reaction section as a vapour, and it may be possible to send it directly to the EDC cracking unit, thus obviating the need for washing. Energy may also be recovered from the hot vapour stream.

Both processes generate residues (impurities and iron catalyst), and an overhead off-gas vent to be treated prior to emission to the atmosphere. The vent contains inerts (from the chlorine feed or intentional addition for safety purposes and suppression of by-product formation) partly saturated with EDC and containing traces of excess ethylene, chlorine and HCl from the reaction, and some unreacted impurities from the ethylene and chlorine fed [ECVM, 1994 #11].

To produce one tonne of EDC by direct chlorination requires 315 kg of ethylene and 800 kg of chlorine. This gives a yield of 96 – 98 %, on ethylene, or 98 % on chlorine [Wells, 1991 #60].

12.2.3 Oxychlorination

Compared with direct chlorination, the oxychlorination process has higher capital investment costs and produces less pure EDC, but it provides the HCl sink that realises the balanced process.

In oxychlorination, EDC and water are formed by the gaseous phase reaction of HCl, ethylene and oxygen over a copper-salt catalyst at 220 – 250 °C and 2 - 6 barg. The reaction-technology can either be fixed or fluidised-catalyst bed. For historical reasons fluidised bed reactors are more widely used. Fluidised bed reactors have better temperature uniformity and lower operating pressures / temperatures [Noyes, 1993 #120]. The reaction is highly exothermic and temperature control is important to minimise the formation of undesirable by-products. The heat of reaction is recovered by surface cooling to generate steam.

The HCl input is recycled from the EDC cracking unit and from VCM purification, but external sources of gaseous, dry HCl with a suitable purity can also be used.

The oxygen source can be ambient air, or oxygen, or a mixture of both. Air systems require air and ethylene to be fed in slight excess of stoichiometric quantities to ensure the high conversion of hydrogen chloride, but this increases the formation of chlorinated by-products and produces

larger waste gas streams. Oxygen systems require a larger excess of ethylene in the feed, and this permits lower-temperature operation giving improved product yield with significantly reduced by-products and volume of vented gases (20 - 100 times smaller when using high purity oxygen [Ullmann, 1998 #80]). However, this must be balanced against the cost of energy expended in producing oxygen from the fractionation of air.

The reaction products are separated from the inert gas-flow by cooling and condensing at decreasing levels of temperature. Further separation of residual EDC from the inert gas mixture may be appropriate using adsorption or absorption, and this captured EDC can be recovered by stripping.

After quenching and condensation, water and EDC (with other organic chlorinated hydrocarbons) separate naturally into two phases since EDC and most of the other chlorinated hydrocarbons have a low solubility in water. Typical exceptions are chloral or chloro-ethanol, which accumulate in the water-phase.

The oxychlorination stage generates a number of waste streams:

- impurities (e.g. mono-chloroethane and 1,1,2 trichloroethane) removed from the oxychlorinator EDC as by-products from the EDC distillation section
- a process vent that requires treatment prior to emission to atmosphere
- an aqueous effluent stream from reactor outlet quenching containing small quantities of dissolved chlorinated organic compounds, and possibly copper (dissolved or as suspended matter) coming from fines of the catalyst entrained outside of the oxychlorination reactor (fluid bed reaction only)
- an aqueous effluent stream from the reactor outlet condensation and phase separation, containing also small quantities of dissolved chlorinated organic compounds
- spent catalyst on a periodic basis (fixed-bed reactors only).

Octo-chlorodibenzofuran and other dioxin related compounds are formed in the oxychlorination reactions as oxygen, chlorine and an organic precursor are all present at high temperatures in the presence of a catalyst. OSPAR data for two different plants showed a total formation of dioxins in the internal process of 6 g/year for a fluid bed and 40 g/year for a fixed bed reactor [PARCOM, 1996 #22□]. However, these quantities are not emitted into the environment since further control measures allow the emission figures given in Table 12.15 and Section 12.5.4.2 to be achieved.

12.2.4 EDC purification

EDC product may arise from direct chlorination ('dry crude'), oxychlorination ('wet crude'), VCM purification recycle or external sources. All EDC must be purified since EDC pyrolysis may be susceptible to inhibition and fouling by trace quantities of impurities. Purification may entail:

- washing with water and caustic to remove traces of HCl, chlorine, entrained catalyst and some water-soluble organics (e.g. chloral, 2-chloroethanol). This is often integrated with the direct chlorination, especially if 'low temperature chlorination' is used
- azeotropic drying / light ends distillation in one or two columns, to remove water and chlorinated organic by-products with a boiling point lower than EDC (e.g. chloroform, ethyl chloride, carbon tetrachloride). Some EDC is lost with the light ends due to the presence of azeotropes
- heavy ends distillation, to remove chlorinated organic by-products and tars with a boiling point higher than EDC (e.g. 1,1,2-trichloroethane and C₄ compounds). Pure, dry EDC is taken overhead the distillation column. Some EDC will be purged with the tars to ensure their mobility

- further light ends and heavy ends processing (by distillation or reaction stages) to recover more EDC, to remove water from the light ends, or to separate the fractions useful as feedstock for other chlorination processes
- a chlorination reaction to convert, into heavies, those light products that would be difficult to separate from EDC using distillation.

This section generates gaseous vents that require treatment prior to release to atmosphere, and this typically takes place in a catalytic or thermal oxidiser, or in a multi-purpose incinerator where chlorinated hydrocarbons are converted to hydrochloric acid gas (HCl). The HCl is consumed in the oxychlorination section, or converted into an aqueous hydrochloric acid for use in aqueous effluent treatment (or elsewhere). There will also be a water phase effluent from the EDC azeotropic drying column that is sent to a waste water stripper section. Additionally light and heavy residues are separated.

12.2.5 EDC cracking

The production of VCM from EDC is achieved by a cracking reaction followed by quenching of the process gas stream. When subjected to thermal cracking in heated furnaces at temperatures of approximately 500 °C, purified EDC splits into VCM and HCl with conversion rates of 50 – 65 %. Rapid cooling of the pyrolysis gases is of major importance for reducing the formation of tars and heavy by-products. Cold, recycled EDC condensate is often used as the quench medium.

The purity of feed has to be greater than 99.5 wt. to reduce coke formation and fouling of the pyrolysis reactor. Coke build-up is periodically removed for disposal. The EDC feed must also be dry to prevent equipment corrosion by hydrogen chloride. The furnace is typically gas-fired and flue gases are released directly to atmosphere.

The dehydrochlorination of EDC to VCM can also be achieved by a catalytic gas-phase reaction although it is used by few VCM producers [Ullmann, 1998 #80]. The catalytic route provides higher selectivities to VCM and reduced coke formation (due to lower temperatures), but it has high catalyst costs and extended shutdown periods.

12.2.6 VCM purification

After the cracking reaction, HCl and unconverted EDC are separated from VCM by two-stage distillation. Unconverted EDC is transferred back to EDC purification and recycled to the cracking furnaces. After an optional hydrogenation stage to remove any traces of acetylene, distilled HCl is recycled as feedstock to oxychlorination. Most of the volatile by-products are removed via the HCl flow to oxychlorination. Liquid VCM product is transferred to storage after an optional step to remove the last traces of HCl. No gaseous emissions are generated in this section and there are only minor quantities of waste (e.g. spent hydrogenation catalyst, and spent alkaline agent for VCM neutralisation).

12.2.7 Storage and loading / un-loading

EDC / VCM production operations can include storage facilities for crude and purified EDC, light and heavy by-products, HCl, and VCM. These are designed and maintained to prevent soil, air and groundwater pollution caused by leaks, in the following manners:

- EDC grades and chlorinated by-products are stored generally in atmospheric tanks at ambient temperatures and are usually blanketed by an inert gas (e.g. nitrogen)
- VCM storage is in spheres or tanks that can either be under pressure at ambient temperature, or refrigerated at approximately atmospheric pressure. There may be pumped circulation facilities which include, probably in the production area, a treatment stage such as drying, acidity removal or addition of stabiliser
- storage of liquefied dry HCl is generally in closed system pressurised vessels at low temperatures
- EDC/VCM plants do not usually have storage facilities for chlorine or ethylene as these are supplied directly by pipeline
- loading and unloading facilities generally have back-balance arrangements, between the storage and the road or rail tank and ship, to reduce emissions. Dedicated VCM liquid lines and return vapour lines remove the need for 'pigging'* or frequent decontamination. Coupling connections are also purged prior to opening. (Note *: 'Pigging' refers to the cleaning of the inside of pipes by forcing the passage of a snugly fitting object).

Atmospheric storage vessels are the main source of gaseous vents in the form of breathing vents, vapour displacement during filling and nitrogen blanketing. The off-gases are partially saturated with EDC and chlorinated by-products. Air emissions may arise additionally from [HMIP UK, 1993 #100]:

- major incidents
- relief valves when the pressure exceeds the set pressure
- relief valves through premature lifting or continuous small leakage
- break-in points before normal maintenance
- stock-tank vent before vessel inspections
- sample-points during analytical sampling
- flexible connections before and after tanker transfers
- leakage from flanges, pump seals, valve glands etc.

Under normal operation there are few liquid effluents although the storage of wet EDC and light ends produces water phases (containing EDC and light ends) that have to be drained off and recycled to the process for the recovery of organics.

12.2.8 Integrated environment protection units

The following abatement units are frequently used on EDC/VCM plants:

- gaseous HCl emergency scrubber
- miscellaneous vent condensers / vent absorbers / vent adsorbers
- gaseous vents thermal or catalytic oxidiser, with HCl absorption system
- waste water stripper (using steam or air) with associated hydrolysis of chloral
- waste water treatment, with sludge separation
- acidic effluent neutralisation.

The organic residues are in some cases re-used as feedstock for chlorinated solvents processes (tri-per, or tetra-per units). Otherwise, they are incinerated either on the EDC/VCM production site with hydrogen chloride (gaseous or solution) recovery, or incinerated off-site.

12.2.9 Auxiliary chemicals and utilities

The following chemicals and utilities may be used in the production of EDC/VCM:

- process water to wash the crude EDC from direct chlorination ('low temperature chlorination') and, in some processes, as scrubbing water for oxychlorination
- sodium hydroxide to wash the crude EDC from direct chlorination (low temperature only), scrub oxychlorinator off-gas, and remove the trace acidity from the distilled VCM
- anhydrous ferric chloride catalyst in the direct chlorination reactor
- oxychlorination catalyst (e.g. based on copper chloride) to replace the continuous catalyst loss in the fluid bed process, and complete replacement of the catalyst charge in fixed bed process
- organic solvent to remove the traces of EDC from the oxychlorination off-gas after condensation
- hydrogen and hydrogenation catalyst to hydrogenate trace acetylene
- hydrochloric acid solution in certain 'low temperature chlorination' processes to remove ferric chloride from crude EDC
- safety water to scrub the hydrochloric acid from cracking when the oxychlorination section is not fully operational, or is shutdown
- anti-fouling agents for some boilers
- nitrogen for inerting
- air, or air/steam mixtures for EDC cracking furnace decoking
- steam or air for direct injection into the waste water stripper.

12.2.10 Energy

The direct chlorination and oxychlorination reactions are highly exothermic. However, the EDC cracking process is an endothermic reaction, and the EDC and VCM separations are energy (steam) consumers. This provides opportunities for energy recovery and re-use. Though highly dependent on the unit design and on the process integration inside the overall chemical facility, some principles are observed in most EDC/VCM units:

- heat recovery on the furnace combustion gases
- heat recovery on the process gas leaving the cracking furnace
- steam generation at the oxychlorination reactor
- in the case of 'high temperature chlorination', the low level heat of reaction is used to vaporise / distil the EDC, and/or to boil some distillation columns
- heat recovery on the gaseous vents thermal or catalytic oxidiser.

12.3 Consumption and emission levels

12.3.1 Raw materials and energy

Typical raw material consumptions for a new world-scale, balanced EDC/VCM unit, that utilises off-site liquid waste incineration, were given in Table 12.3 and are elaborated below [CEFIC, 1999 #70]:

- the **ethylene** consumption of 0.47 t/t VCM is determined by the reaction stoichiometry, but it may be fed to the reactor in slight excess to ensure that all the chlorine is utilised
- the **chlorine** consumption figure of 0.60 t chlorine / t VCM is lowered to 0.58 if HCl is recovered from the on-site incineration of liquid wastes and re-used in the oxychlorinator
- **oxygen** is used at a rate of 0.14 t/t VCM in oxygen-based oxychlorination units. In air-based units the figure will be zero, but the consumption of ethylene, chlorine and electricity are all higher
- the level of **energy** use is very dependent on the degree of local energy integration, but typical figures are 0.2 t of steam, 1 MWh of natural gas and 0.2 MWh of electricity per tonne of VCM. Oxygen based processes will also use significant additional electricity for the separation of oxygen from air. Certain process configurations may have no net steam consumption, except for start-up.

Oxychlorination is an exothermic process and waste heat is recovered through steam generation. The heat input from fuel gases into the EDC cracker and the waste gas incinerators is partially recovered for energy optimisation and steam production purposes respectively. The incinerators and crackers may operate with a mix of waste gases, natural gas and hydrogen.

To produce one tonne of EDC by oxychlorination requires 302 kg of ethylene and 760 kg of chlorine. This gives a yield of 93 – 97 %, on ethylene, or 96 – 99 % on chlorine [Wells, 1991 #60]. For a stand-alone EDC unit using ethylene chlorination, the consumptions would typically be 0.29 t ethylene and 0.73 t chlorine / t EDC product. Energy consumption is minor when the high temperature chlorination process is used [CEFIC, 1999 #70]. Specific examples of energy and raw material consumption are given in Table 12.4.

Data source	Production unit	Consumption data
The Netherlands ⁽¹⁾	EDC cracker	78.7 Nm ³ natural gas and 32.4 Nm ³ hydrogen / tonne VCM
	General waste gas incinerator	8.4 Nm ³ natural gas/tonne VCM
	Oxy waste gas incinerator	23 Nm ³ natural gas and 149.5 Nm ³ hydrogen / tonne VCM
Germany	Direct chlorination and oxychlorination.	13 GJ/t VCM.
	VCM plant	0.6 t/t steam (at 14 - 21bar), 64.1 kWh/t electric power and 126.4 Nm ³ /t natural gas.
Italy	Three VCM plants	Energy consumption (steam, power and fuel) in the range 1.115 to 1.822 MWh/tonne of VCM production.

1. Plant has a steam generation deficit of 0.80 tonne steam/tonne VCM (based on steam gross import of 0.92 tonne/tonne VCM, steam consumption of 2.59 tonne/tonne VCM, steam generation of 1.79 tonne/tonne VCM, and steam gross export of 0.12 tonne/tonne VCM).

Table 12.4: Raw material and energy consumption in European example plants [InfoMil, 2000 #83] [UBA (Germany), 2000 #91] [EVC Italia SpA, 2000 #124]

12.3.2 Air emissions

VCM, as a carcinogen, is the gaseous pollutant of most concern, but other potential pollutants include EDC and chlorinated hydrocarbons such as carbon tetrachloride. The oxychlorination reaction is a source of dioxin related components, predominantly the octo-chlorodibenzofuran congener [ECVM, 1994 #11]. Emissions to air may derive from:

- flue gas from thermal or catalytic oxidation of process gases (vents and tank vapour losses) and from incineration of liquid chlorinated wastes
- VOC emissions from maintenance of the process or abatement equipment (e.g. thermal / catalytic oxidiser, incinerator) - down-time on the abatement equipment is usually the main cause of VOC emissions
- process off-gases from reactors and distillation columns
- safety valves
- storage of raw materials, intermediates, and products. The gas phase in atmospheric storage tanks for EDC grades and chlorinated by-products will contain EDC and volatile chlorinated by-products that are displaced during tank filling, nitrogen supply during inert blanketing and breathing due to temperature variations. Off-gas from VCM storage tanks only occur infrequently when an excess of inerts (typically nitrogen) is introduced, or from vapour return from loading operations
- sampling systems
- VOCs from fugitive sources such as valves, flanges, vacuum pumps and waste-water collection and treatment systems
- flue gas from natural gas (and maybe hydrogen) combustion in the EDC cracking furnace contains no chlorinated compounds, only NO_x and CO
- vent gas from process vents not connected to treatment systems (e.g. low pressure storage, back-pressure sensitive analysers, vents with emissions below national mass emission limits).

Table 12.5, Table 12.6, Table 12.7 and Table 12.8 give air emissions from example plants in Member States.

Plant	Emissions
Plant 5 (Internal No. A24) ⁽¹⁾	EDC cracking to VCM: NO/NO ₂ < 200 mg/m ³ , CO < 100 mg/m ³ HCl recovery ⁽⁴⁾: SO ₂ and SO ₃ 1 mg/m ³ , NO/NO ₂ 70 - 137 mg/m ³ , CO 0.1 - 3 mg/m ³ , Total C 0.1 - 1.6 mg/m ³ , Dust 0.4 - 1.3 mg/m ³ . HCl < 2.7mg/m ³ HF < 0.1 mg/m ³ . PCDD/F emissions: 40 - 1000 mg ITEQ/a
Plant 5a (Internal No. B13) ⁽²⁾	Measured emissions (1/2 h - average): NO _x 130 mg/m ³ , CO 50 mg/m ³ (8 g/t product), Total C 7.1 mg/m ³ (1.1 g/t product), HCl 10 mg/m ³ (1.5 g/t product)
Plant 5b (Internal No. B14) ⁽³⁾	Waste gas of the VC - plant is removed in a combustion plant, measured data of the tributary waste gas stream are not available.
Note 1. Production capacity 150 kt/yr using direct chlorination & oxychlorination	
Note 2: EDC production only (capacity 220 kt/yr)	
Note 3: VCM production only (capacity 120 kt/yr)	
Note 4: 'HCl recovery' is the main emission source of the EDC/VC plant where the flue gases are treated and the HCl recycled to the oxychlorinator.	

Table 12.5: Emissions to air from German EDC/VCM plants
[UBA (Germany), 2000 #91]

	Porto Marghera	Ravenna	Porto Torres
VOC	VCM 2.2 tpa ⁽¹⁾ EDC 2.5 tpa ⁽¹⁾	VCM 1.6 tpa ⁽¹⁾ EDC 1.3 tpa ⁽¹⁾	VCM 2.1 tpa ⁽¹⁾ EDC 6 tpa ⁽¹⁾
NO_x	Combustion 105 tpa ⁽²⁾	Combustion 12.1 tpa	Combustion 8 tpa ⁽²⁾
CO₂	Oxychlorination 4.3 kt/yr Combustion 88 kt/yr ⁽²⁾	Oxychlorination 0 kt/yr ⁽³⁾ Combustion 13.2 kt/yr	Oxychlorination 1.5 kt/yr Combustion 22.1 kt/yr ⁽²⁾
CO	17.06 tpa 13.7 mg/m ³		1.4 tpa 8 mg/m ³
HCl	4.55 tpa 3.62 mg/m ³		<0.2 tpa <1 mg/m ³
1) From fugitive releases. Main vent to thermal oxidation.			
2) Figure includes emissions from thermal oxidation unit.			
3) Fixed bed oxychlorination unit includes a carbon dioxide neutralisation column.			

Table 12.6: 1998 emissions to air from Italian EDC/VCM plants
[EVC Italia SpA, 2000 #124]

	Emissions
EDC	15.0 tpa (2.1 tpa from point sources and 12.9 tpa from fugitives) based on EDC production of 148.5 kt/yr
VCM	16.8 tpa (0.2 tpa from point sources and 16.6 tpa from fugitives) based on VCM production of 125.1 kt/yr
Other VOCs	11.3 tpa (1.9 tpa from point sources and 9.4 tpa from fugitives) giving a loss of 0.16 kg total VOC/t product.
NO_x	9 tpa (from incineration)
CO₂	16074 tpa (764 tpa from oxychlorination and 15310 tpa from incineration)
CO	385 tpa (384 tpa from oxychlorination and 1 tpa from incineration)
Note: EDC, VCM and VOC data is for 1998. CO ₂ , CO and NO _x data for 2000.	

Table 12.7: Emissions to air from Swedish EDC/VCM plants
[SEPA, 2000 #76]

Source	Type	Pollutant	Emission factor (g/tonne VCM)	Concentration (mg/Nm ³)
General chlorinated compounds incinerator (continuous)	Combustion	chlorine	0.2	45
		carbon monoxide	2.4	
		chloroform	0.1	
		nitrogen oxides	13.0	
EDC cracker (continuous)	Combustion	carbon monoxide	3.7	45
		nitrogen oxides	50.0	
Oxy gas incinerator (continuous) NOT PART OF PLANT	Combustion	carbon monoxide	9.3	5 - 42
		hydrochloric acid	60.3	13 - 75
		ethylene	4.6	0 - 20
		nitrogen oxides	179.7	139
Bypass scrubber of general chlorinated compounds incinerator (discontinuous)	Point source	VCM	3.7	
		EDC	30.5	
		total chlorinated hydrocarbons	52.6	
Oxy waste gas incinerator bypass vent (discontinuous)	Point source	carbon monoxide	63.7	
		EDC	1.1	
		VCM	0.4	
		ethylene	68.8	
Tank farm and other emissions (discontinuous)	small point sources	EDC	22.2	
		VCM	0.3	
		ethylene	2.3	
Fugitive emissions (continuous)		EDC	10.3	
		VCM	1.1	
Total EDC / VCM plant		carbon monoxide	79.2	
		EDC	64.1	
		VCM	5.4	
		hydrochloric acid	60.3	
		chloroform+tetra	3.6	
		ethyl chloride	3.5	
		nitrogen oxides	242.6	
		ethylene	77.8	

Note: The EDC/VCM facility is a combined process, but not completely balanced, as HCl is imported and EDC is exported. The process boundary includes the units for: chlorination, EDC washing, EDC purification, EDC cracker, HCl distillation, VCM distillation, oxychlorination, storage of EDC and VCM, ship and railcar loading, EDC/VCM waste gas incinerator, and waste water steam strippers. The process boundary does not include: chlorine recycle facility, oxy-waste incinerator, utilities, biological waste water treatment plant.

Table 12.8: Emissions to air from a Dutch EDC/VCM plant (1998)
[InfoMil, 2000 #83]

Table 12.9 gives a summary of emission factors (derived from a literature search) for EDC/VCM plants.

Unit	Pollutant	Pollutant load	Comment
EDC production	NMVOC	2500 g/t product	General
		2500 g/t product	Range 2.5 - 5870 g/ te
	VOC	12050 g/t product	Oxychlorination
		650 g/t product	Direct chlorination
		0 g/t product	Caustic scrubber, reactor vessel, distillation unit
		90 te/process unit	Fugitive emissions
		90 g/t product	Total emissions
18 g/t product	Fugitive emissions		
VCM production	NMVOC	2500 g/t product	General
		2500 g/t product	Range 20 - 5000 g/ te
		20 g/t product	General
		20 g/t product	Former FRG,1990
		2500 g/t product	Former GDR,1990
	EDC	700 g/t product	Emissions from heavy ends streams, uncontrolled, range 600 - 800 g/ te
		16 g/t product	Controlled by heavy ends and waste incineration, <16 g/ te
	VOC	3250 g/t product	General
		0 g/t product	Cracking furnace
		100 g/t product	HCl recovery
		1000 g/t product	Light-ends recovery
		1000 g/t product	Drying column, dichloroethane
		1000 g/t product	Drying column, vinylchloride monomer
		700 g/t product	Product recovery still
		0 g/t product	Cracking furnace decoking
138 te/process unit		Fugitive emissions	
20 g/t product	Fugitive emissions		

Table 12.9: Review of air emission factors for EDC/VCM plants
[Rentz, 1999 #114]

12.3.3 Water emissions

In addition to the general effluents from boiler purges, cooling system purges, seal water and inorganic salts from water demineralisation, EDC/VCM plants have specific effluent streams from:

- wash water and condensate from EDC purification (containing VCM, EDC, other volatile chlorinated hydrocarbons and non-volatile chlorinated material such as chloral or chloroethanol)
- oxychlorination reaction water
- other condensates
- water seal flushes from pumps, vacuum pumps and gas-holders
- cleaning water from maintenance operations
- intermittent aqueous phase from the storage of crude (wet) EDC and light-ends.

The main categories of pollutants in these effluents are:

- EDC and other volatile chlorinated organic compounds
- non-volatile chlorinated organic compounds
- organic compounds, such as sodium formate glycol and chloroform
- copper catalyst (when oxychlorination uses fluidised-bed technology)
- dioxin related components (with a strong affinity to catalyst particles).

Waste water emissions from example plants in Member States are given in Table 12.10, Table 12.11 and Table 12.12.

Source	Destination	Pollutant	Pre-treatment		Post-treatment	
			Emission factor (g/tonne VCM)	Concentration (mg/l)	Effluent load (g/tonne VCM)	Reduction efficiency (%)
Steam stripper waste water outlet	Central biological treatment plant	chloride	9608.0	6742.0	9608	0
		copper	5.5	<3.1	0.2	97
		COD	1022.9	715		> 90
		Kj-nitrogen	18.4			> 90
		Chloroform	0.3		0	100
		EDC	1.8		0.03	98
		2-chloro-ethanol chloral	17.9		0	100
1.5		0	100			
Cooling water	Surface water	EDC	< 6.5			

Note: Process boundary is as defined for Table 12.8.

Table 12.10: Waste water from a Dutch EDC/VCM plant before and after treatment (1998)
[InfoMil, 2000 #83]

	After pre-treatment of waste water:	After biological waste water treatment
Plant 5 (Internal No. A24) ⁽¹⁾ Oxychlorination	Waste water amount: 20 m ³ /h (1.1 m ³ /t VCM) COD 1250 mg/l (1.3 kg/t VCM) Chlorides 20000 mg/l (21 kg/t VCM) AOX 2.5 mg/l (2.7 g/t VCM) Cu 0.1 mg/l (0.1 g/t VCM) EDC 0.1 mg/l (0.1 g/t VCM)	
Plant 5a (Internal No. B13) ⁽²⁾	Waste gas washing, cleaning procedures and rain water collection = 270 m ³ /d COD (before stripper) 100 mg/l (50 g/t) AOX (before stripper) 10 mg/l (5 g/t) EDC (after stripper) 5 mg/l (2.5 g/t)	Waste water amount: 0.5 m ³ /t EDC EDC 50 mg/t AOX 200 mg/t COD 5 g/t
Plant 5b (Internal No. B14) ⁽³⁾	No process waste water from the VC plant	

Note 1: Production capacity 150 kt/yr using direct chlorination & oxychlorination.
Note 2: EDC production only – by direct chlorination (capacity 220 kt/yr).
Note 3: VCM production only (capacity 120 kt/yr)

Table 12.11: Effluent from German EDC/VCM plants
[UBA (Germany), 2000 #91]

	Porto Marghera	Ravenna	Porto Torres
Total flow - m³/year	210000	50800	200000
Copper – kg/yr (mg/l)	52.5 (0.25)	4 (0.08)	(<3)
Suspended solids – kg/yr (mg/l)	1870 (8.9)	7112 (140)	40000 (200)
COD – kg/yr (mg/l)	185000 (880)	40000 (780)	140000 (700)
EDC – kg/yr (mg/l)	< 4.2 (<0.02)	61 (1.2)	<200 (<1)

Table 12.12: Waste water from three Italian EDC/VCM plants (prior to treatment)
[EVC Italia SpA, 2000 #124]

The manufacture and use of 1,2 dichloroethane (EDC) is covered by EC Directive 90/415/EEC and is relevant to water releases from the production of vinyl chloride monomer (VCM). This stipulates EDC emission values of <2.5 mg/l or 5g/tonne of production.

12.3.4 Liquid residues

Direct chlorination does not generate significant quantities of by-products as the catalyst selectivity is good. By product generation in the oxychlorination reaction is related to: temperature uniformity and control, feed purity, oxygen source (air or pure oxygen), catalytic selectivity and gas-catalyst contact [Noyes, 1993 #120].

The EDC/VCM process generates liquid residues (by-products) streams extracted from the EDC distillation train. These residues are a mixture of chlorinated hydrocarbons and comprise of products heavier than EDC (such as chlorinated cyclic or aromatic compounds) and light wet products (C_1 and C_2 chlorinated hydrocarbons with lower boiling points than EDC). In some processes, light dry products may also be formed. The heavies may contain suspended iron salts that were used as catalyst in the direct chlorination.

The quantity of residues is in the range of 25 to 40 kg / t VCM, although in stand-alone EDC units using direct chlorination the liquid residues are generally less than 5 kg / t EDC [CEFIC, 1999 #70]. The chlorine content of liquid residues is typically more than 60 % by weight, and since this represents unused raw material, efforts are nearly always made to recover chlorine in the form of:

- gaseous hydrogen chloride for re-use in the oxychlorinator (from solution, or by high temperature oxygen combustion upstream of an oxychlorination reaction)
- marketable hydrochloric acid solution (by incineration and water absorption)
- feedstock for chlorinated solvents such as carbon tetrachloride / tetrachlorethylene (high temperature chlorination of a hydrocarbon).

12.3.5 Solid wastes

The main solid wastes from EDC/VCM plants are spent oxychlorination catalyst, direct chlorination residues and coke. Generic wastes also arise from waste water treatment sludges, tank / vessel sludges and maintenance activities.

Spent oxychlorination catalyst is removed either continuously (by the entrainment of fines in fluid bed reactors), or periodically (when replacing exhausted fixed bed reactors). In the fluid bed process, small quantities are also removed for disposal during maintenance activities. Depending on the process, the catalyst is recovered in a dry form or wet form (after settling and/or filtration of waste water). Small quantities of heavy chlorinated organics (e.g. dioxins) adsorb onto waste catalyst and this determines the disposal route (usually incineration or landfill). The amount (dry basis) is in the range of 10 to 200 g / t VCM [CEFIC, 1999 #70].

Direct chlorination residues are generally a pure or mixed inorganic iron salts. In high temperature chlorination, residues are recovered with the organic heavies as a suspended solid. In low temperature chlorination, residues are recovered with waste water and require alkali precipitation prior to separation by settling or filtration (possibly with the spent oxychlorination catalyst). Rates of arising, on a dry basis, are from 10 to 50 g / t VCM [CEFIC, 1999 #70].

Coke is formed by the thermal cracking of EDC and will contain residual chlorinated hydrocarbons (but is free of PCDD/F). Coke is removed from the VCM by filtration. It also arises from decoking of the cracking section. The total rate of arising is in the range of 0.1 to 0.2 kg / t VCM [CEFIC, 1999 #70]. Sweden report a coke generation rate from the cracker alone (i.e. excluding the quench) of 0.006 kg/t VCM.

The final purification of VCM may involve the neutralisation of acidity using lime and this generates a **spent lime** waste.

German plants report waste arisings of [UBA (Germany), 2000 #91]:

- **plant 5:** 55.9 tpa slag residuals of chlorinated hydrocarbons and
- **plant 5a:** sludge from waste water treatment (to landfill) and 2600 tpa high boiling halogenated hydrocarbons (to combustion plant)
- **plant 5b:** 16 kg/t waste for removal in a combustion plant.

Figures for a Dutch plant are given in Table 12.13.

Source	Destination	Type of hazardous waste	Emission factor (g/tonne VCM)
Tars from purification	External incineration	chlorinated organic compounds	68
Waste water treatment sludge	External incineration	chlorinated organic compounds, copper contents	The VCM plant is not the single contributor to this waste stream.

Table 12.13: Waste generation by a Dutch EDC/VCM plant [InfoMil, 2000 #83]

12.4 Techniques to consider in the determination of BAT

12.4.1 Process design

A number of techniques can be adopted at the process design stage to minimise environmental emissions [CEFIC, 2000 #105].

12.4.1.1 Direct chlorination

The choice between **high and low temperature variants** of the direct chlorination unit process has to weigh-up the respective advantages and disadvantages. High temperature provides the effective recovery of the reaction heat and comparatively low selectivity. Low temperature chlorination produces more waste water as the crude EDC may require washing with water / caustic to remove the ferric chloride reaction catalyst. The high temperature variant would probably be selected at any new plant, essentially for economic reasons.

Likewise there is a choice of **chlorine source** as it is possible to use cell-gas chlorine, vaporised liquid chlorine or chlorine liquefaction tail gas. The different chlorine sources all have very different inerts contents. The quality of chlorine is also site-specific as it depends on the integration of the chlorine and EDC production. The chlorine may unavoidably contain oxygen that can create flammable gas mixtures and so techniques like nitrogen inerting may be required to safely handle direct chlorination vents.

There is constant research into alternative **catalysts** but none have yet shown conclusive performance data that justifies replacement of the generally used ferric chloride based catalyst.

12.4.1.2 Oxychlorination

There is a choice of oxychlorinator **oxygen source** between pure oxygen and air, and both have their merits. Oxygen-based processes involve lower losses of ethylene and EDC, and smaller off-gas volumes. Air-based processes allow increased flexibility in finding external HCl. However, an oxygen-based process would probably be selected for a new plant where an oxygen supply could be found economically.

The conversion of existing reactors to enable the consumption of pure oxygen is desirable but costs may make it unfeasible. One Italian plant retro-fitted oxygen to an air-based plant because the resulting reduction in off-gases was in-line with limited capacity of the site incinerator (second TWG meeting).

The reactor type can either be **fixed or fluidised bed** and both alternatives have their applications. In fluidised bed reactors, copper salts are lost into the process waste water because of catalyst abrasion. The catalyst loss can vary significantly dependant on factors such as catalyst design, reactor design and operating conditions. In the fixed bed process, the catalyst must be exchanged at intervals, but no continuous losses are experienced.

Fixed bed oxychlorination technology avoids a continuous transport of catalyst particles into aqueous effluent and so there is no requirement for the technology to remove solids from waste water (as with fluid beds). The overall wastes coming from the two reactor types are similar, but there is a continuous emission of catalyst from the fluid bed whilst the inventory of the fixed bed has to be changed from time to time. In addition, the risk of an accidental catalyst release is smaller with the fixed bed process [EVC Italia SpA, 2000 #124].

Octo-chlorodibenzofuran and other dioxin related compounds are formed by the oxychlorination reactions. These compounds are concentrated in the heavy end residues from EDC distillation and in the catalyst matrix. Although there is the potential for more dioxins to be formed in fixed beds, there is virtually no catalyst carryover to the effluent systems as there is with fluidised beds. Purified EDC and oxychlorination process off-gas do not contain significant amounts of dioxin compounds.

The minimisation of waste generation in the oxychlorination step can be approached in two ways [Noyes, 1993 #120]:

1. Improve the process to reduce the formation of undesirable by-products, for example:
 - use fluidised bed reactors rather than fixed bed reactors (N.B. CEFIC have doubts about this choice)
 - modify fixed bed reactor design (e.g. increase catalyst concentration along reaction path to reduce hot spotting, minimise radial temperature gradient by optimising tube diameter, staged air/oxygen injection)
 - use oxygen instead of air (N.B. CEFIC have doubts about this choice)
 - selective hydrogenation of acetylene in the feed
 - use improved catalysts (with regard to selectivity, stability and attrition resistance)
 - re-examine reactor conditions (e.g. reduce bubble size in fluidised beds, variations in the ethylene recycle rate, decrease operating pressure, and quicker post-reaction cooling).
2. Avoid the oxychlorination step by replacing it with an alternative, low-waste process. Although none have been developed at industrial scale, some example processes are:
 - HCl oxidation step – the purified HCl from the pyrolysis is oxidised to chlorine which is then recycled back to the direct chlorinator. The process has high capital and operating costs
 - mixed feedstock option – with a feedstock of ethylene and acetylene the HCl produced in the pyrolysis step can be reacted with acetylene to produce VCM. The process was reported as having poor economic feasibility and generates a spent mercuric chloride catalyst
 - Akzo-Zout Chemie process – ethylene, sodium chloride, oxygen and carbon dioxide are converted to EDC (for subsequent pyrolysis to VCM) and sodium bicarbonate (calcined to soda ash).

12.4.1.3 Pyrolysis

By-product formation from the pyrolysis reaction can be reduced by a number of practised and postulated techniques [Noyes, 1993 #120]:

- use of additives to EDC the feed – additives such as chlorine and carbon tetrachloride have been reported in patent literature to suppress methyl chloride formation. The presence of nitromethane was reported to increase EDC conversion to 92.5 %
- more stringent control of EDC feed purity – reduces fouling and by-product formation
- rapid quench rate – rapid cooling of the pyrolysis off-gas reduces by-product formation.

12.4.2 Air emissions

The sources of air emissions from EDC/VCM plants may include losses from equipment, pumps, compressors, flanges, valves and open drainage systems. Emissions from process stacks connected to air pollution control equipment are generally of lower magnitude, although it may be necessary to discharge vents to atmosphere, for limited periods of time, to accommodate downtime and trips on pollution control systems. A combination of preventative, recovery and treatment techniques can be used for the losses to air of VCM, EDC and other chlorinated hydrocarbons and these are outlined below [Environment Agency (E&W), 1998 #1] [InfoMil, 2000 #83] [SEPA, 2000 #76] [PARCOM, 1996 #22].

12.4.2.1 Prevention

Fugitives. Since VCM is a known carcinogen there have been strenuous efforts over recent years to minimise workplace exposure and environmental releases, especially from fugitive sources. Rigid LDAR (leak detection and repair) regimes have proven value in the prevention of fugitive emissions and have particular relevance to EDC/VCM plants. The techniques to prevent and minimise fugitive emissions of air pollutants are described in 5.3.1.3.

The volatile components of contaminated process effluent may pass to the atmosphere and closed collection systems (sewers) can water reduce the emission. If process effluent is stripped to less than 1 ppm EDC, then this reduces air emissions from any subsequent effluent treatment.

Relief vents. To prevent leaks from relief vents, rupture disks are used in combination with safety valves. The pressure between the rupture disc and the safety valves is monitored to detect any leaks. Where not restricted by safety requirements or volume restrictions, safety vents may be combusted in a thermal or catalytic oxidiser.

Furnaces. Emissions from flue gas from heating and cracking furnaces are minimised by efficient design and operation (e.g. heat recovery, oxygen excess monitoring).

Storage. The vents on atmospheric storage tanks for EDC and chlorinated by-products are stored under inert blanketing (e.g. nitrogen) and equipped with refrigerated reflux condensers or by connecting to gas recovery and/or a thermal or catalytic oxidiser. However, consideration must be given to safety considerations of retrofitting abatement equipment onto atmospheric tanks. Relief systems from HCl storage systems are usually connected to scrubbing facilities.

Off-gases from VCM storage tanks are abated with refrigerated reflux condensers, or by connecting to VCM recovery system or to another appropriate vent treatment technique. Vents from the monomer recovery and blanketing systems should be routed to a thermal or catalytic oxidiser. Remote shut-off valves for VCM storage can be installed. Some other specific techniques for VCM storage include [HMIP UK, 1993 #100]:

- fire-protection to prevent overheating and collapse (tanks and their supports are insulated and/or equipped with water deluge facilities)
- tanks are located in a containment area with walls less than one metre high so that vapour does not accumulate, and graded so that any liquid leakage does not remain beneath the tank. The containment area should also be capable of retaining any fire-fighting water

- pressure relief is normally direct to atmosphere and systems are usually duplicated (with appropriate interlock protection) so that valves can be maintained and tested. Where liquid entrainment in the relieved gas is probable or liquid overfill is a reasonable possibility, an expansion tank may be installed before the final release to air.

Loading/unloading. Emissions of EDC/VCM can arise from the decoupling of pipe connections if they are not fully evacuated beforehand. Provisions are required to purge coupling connections to EDC/VCM recovery or a thermal / catalytic oxidiser. The installation of vapour return (closed-loop) systems greatly reduces EDC/VCM emissions when loading mobile tanks (trucks, railcars or ships) as the gas flow between the supplying and receiving tanks are in balance. Alternatively, and particularly for remote loading/unloading operations, any vent flow should be preferably connected to a recovery system. Care must be taken in VCM systems to avoid any increase in oxygen content in order to prevent the formation of vinyl polyperoxide.

Loading stations may have automatic shut down linked to 'excess flow' detectors or by 'proximity' switches detecting vehicle movement. Other installations have found it useful to have VCM gas detectors ('sniffers') located at potential leakage points such as pump pits or boat-loading wharves, which trigger the appropriate shutdown system on detection of about 200 ppm(v) of VCM [HMIP UK, 1993 #100].

In Sweden activated carbon adsorption is used for abating the emissions from the loading of EDC into boats and achieves 99 % removal of EDC. The carbon filter is replaced after a certain number of boat loads (second TWG meeting).

12.4.2.2 Recovery of chlorinated organics

EDC and VCM may be recovered from some inert gas flows and recycled to the process. This has commercial and environmental benefits. It is possible to recover chlorinated organic compounds from the following sources (vents):

- direct chlorination reactor
- oxychlorination reactor
- distillation columns and dryers for by-products including light & heavy-ends
- VCM/EDC separation
- VCM purification
- vacuum pumps
- sampling systems
- tanks for EDC, VCM and by-products
- vents from loading and unloading stations
- contaminated waste water collecting system
- buffer tank for contaminated waste water.

The recovery of chlorinated organic compounds can utilise such methods as:

- direct recycling to the process
- refrigeration and condensation
- absorption in solvents, followed by stripping
- adsorption on solids, followed by desorption
- membrane separation.

12.4.2.3 Treatment

Many process vessels are equipped with vents to prevent pressure build up by inert gases. These vents can also be operated to depressurise and flush equipment during emergencies and prior to maintenance. All vents can be sent to air pollution control equipment, except for:

- vents for gases during the transient periods where they contain explosive mixtures of organic compounds and oxygen
- major relief vents which, due to their large flow, will overload the treatment system.

After recovery options have been exhausted, the concentrations of chlorinated compounds and ethylene in off-gas can be further reduced by such treatment techniques as:

- **Thermal oxidation.** Most process and storage vents can be collected for combustion in a purpose built high temperature oxidation unit. The unit should be able to achieve emission levels of 1 mg/m³ for EDC and VCM (in total), 0.1 ng/m³ for dioxins (TEQ) and 10 mg/m³ for HCl. Waste gas from the oxychlorinators may require destruction in a dedicated unit.
- **Catalytic oxidation.** Catalytic oxidation is restricted to low concentrations of organic compounds, as off-gas temperatures will otherwise be too high and inactivate the catalyst. The concentrations and temperatures are controlled in an effective range in which the desired degradation of VOCs is achieved. NO_x are not generated in catalytic oxidation and the formation of PCDD/F is minimised.
- **Hazardous waste incineration.** Incineration in a multi-purpose unit for liquid and solid wastes. Such units are likely to be covered by the Hazardous Waste Incineration Directive (94/67/EC) which sets limits for a wider range of substances and requires their continuous monitoring. The requirements of Directive 94/67/EC will be superseded by the requirements of Directive 2000/76/EC in December 2002, for new plants, and in December 2005, for existing plants.

After incineration, the HCl formed from the chlorinated organic compounds can be recovered by absorption either in water/hydrochloric acid (for recovery of HCl and re-use within the process), or in water / alkaline solution (for HCl emission reduction).

In combination, these techniques can achieve the concentrations shown in Table 12.14:

Parameter	Maximum emission level (Note 1,2)
VCM	1 mg/Nm ³
EDC	
HCl (as total chloride ion)	10 mg/Nm ³
Chlorine	5 mg/Nm ³
Dioxin (I-TEQ)	0.1 ng/Nm ³
1. Maximum emission levels are averages with no single measurement higher than twice the value (except the dioxin value which is an annual average).	
2. Concentrations are adjusted to: 213 °K, 101.3 kPa, dry gas, 11 % oxygen by volume.	

Table 12.14: Maximum emission levels in treated off-gas
[CEFIC, 2000 #105]

In Sweden activated carbon adsorption is used for polishing incinerator off-gases. Purification efficiency varies with chemical compound but reported removal rates are 99.9 % for hexachlorobenzene and 80 - 85 % for dioxins. The outgoing concentrations are in the order of 0.04 ng I-TEQ dioxins/m³. The filter unit has a diameter of 3 - 4 m and is expected to last about two years before needing replacement. The spent carbon is incinerated (second TWG meeting).

The retrofitting of a vent treatment system to an existing plant may be problematic for equipment that is unable to tolerate additional back-pressure and this may preclude the connection of some minor vents.

The typical costs of installed off-gas treatment by combustion of the vents from a balanced VCM plant is estimated at 10 to 15 million Euro, including a provision for vent collection. The cost of the combustion unit itself is roughly 5 million Euro [CEFIC, 2000 #105].

12.4.2.4 Monitoring

The monitoring of stack emissions will include:

- continuous on-line instrumental monitoring of O₂ and CO for thermal/catalytic oxidisers
- sampling at intervals for C₂H₄, VCM, EDC, Cl₂, HCl and dioxin.

Monitoring of fugitive emission concentrations can include:

- continuous, on line instrumental monitoring of VCM and EDC at numerous (e.g. 10 - 20) points in the plant airspace
- spot checks of VCM and EDC with hand-held instruments, to detect leaks
- personal monitors (e.g. activated carbon buttons) for VCM.

The measurement of mass emissions from fugitive sources is difficult, but it can give a useful indication of the actual amount of emissions from fugitive leakages for comparison with emissions from other sources.

12.4.3 Water emissions

A combination of preventative, recovery and treatment techniques can be used for effluents from the EDC/VCM process. These are outlined below [CEFIC, 2000 #105] [Environment Agency (E&W), 1998 #1] [InfoMil, 2000 #83] [SEPA, 2000 #76] [PARCOM, 1996 #22].

Some effluent source reduction techniques have been suggested by [Noyes, 1993 #120]:

- use of solid absorbent for the removal of EDC from the direct chlorinator effluent
- the use of boiling reactors for direct chlorination produces EDC in vapour form and reduces the need to remove catalyst from the effluent and EDC product
- a multi-stage counter-current contactor for EDC pyrolysis feed drying produces a smaller, more concentrated effluent stream.

Volatile chlorinated organic compounds such as EDC, VCM, chloroform and carbon tetrachloride can be effectively removed by steam or air stripping to effluent concentrations of less than 1 mg/l. The stripped compounds can be recycled to the process. The installed cost of a waste water stripping plant treating a flow of 40m³ per hour is 3 million Euro [CEFIC, 2000 #105].

Depending on the plant arrangement, stripping can be performed at atmospheric pressure, under pressure or under vacuum. Stripping at atmospheric pressure is the simplest way, but pumps are needed for column bottoms and for EDC recovery from the top. Stripping under pressure is more critical in terms of chemical efficiency, but can be carried without pumps as the pressure is the same as in the oxychlorination section. Vacuum stripping gives the best stripping efficiency, but requires larger columns and vacuum pumps [EVC Italia SpA, 2000 #124].

EDC from the top of effluent strippers is condensed by a water condenser or is condensed in the main oxychlorination condensers (only for pressure columns). Untreated waste water enters the column at pH >10, in order to avoid corrosion and to allow chloral destruction. The column has

two or three packing beds in stainless steel or plastic. Column can be built with internal lining, or can be built in special metal (e.g. Incoloy) if neutralisation is at outlet of the stripper [EVC Italia SpA, 2000 #124].

Some of the oxychlorination by-products are non-volatile chlorinated compounds (e.g. chloral or 2-chloroethanol). Alkaline treatment (at the right conditions of temperature, pH and residence time) can convert them into compounds that can be stripped (e.g. chloroform) or are degradable (e.g. ethylene glycol, sodium formate).

The main waste water contaminants after steam stripping are chlorinated hydrocarbons, chloride and copper from the oxychlorination catalyst. The discharge of biodegradable compounds can be reduced efficiently by aerobic biological treatment.

The entrained copper catalyst from the oxychlorination process can be partly removed by alkaline precipitation at pH 8 - 9 or above and separation by settling/flocculation. The biological treatment installation may be equipped with a physical separation unit to remove copper containing sludges. Electrolysis is also used if effluents additionally contain ammonia. Treated effluents of under 1 mg Cu /litre are reported.

Dioxin, and related compounds, generated during oxychlorination have a strong affinity to particle surfaces such as oxychlorination catalyst. The presence of dioxin related compounds in effluent from EDC production is influenced by the technology used in the oxychlorination process:

- fixed bed oxychlorination has virtually no carryover of copper catalyst which can be contaminated with dioxin
- fluid bed technology allows some catalyst fines to transfer to process waste water.

These compounds will be partly removed in the copper precipitation, together with the catalyst residues (metal sludge). Additional removal of PCDD/F related compounds can be achieved by flocculation and settling or filtration. With biological treatment an additional removal of the PCDD/F related compounds may take place by adsorption on activated sludge. Depending on the efficiency of the physicochemical treatment, disposal of this sludge must recognise this contamination. Adsorption on activated carbon is used at some plants as additional treatment or as stand-by installations to be used when emission standards for chlorinated compounds cannot otherwise be complied with.

Germany report that PCDD/F figures before treatment are about 100 µg TEQ/t EDC and that the separation of the suspended solids (catalyst) by flocculation gives a sludge with a PCDD/F-concentration of about 500 µg TEQ/kg. The dioxin congener distribution is very strongly dominated by octochloro-dibenzofuran.

In combination, these techniques can achieve the effluent concentrations shown in Table 12.15.

Component	Concentration / load (annual average) ⁽⁴⁾
VCM	0.1 mg/l
Chlorinated hydrocarbons ⁽¹⁾	0.7 g/tonne of EDC purification capacity ⁽²⁾
Dioxins	1 µg I-TEQ TCDD/tonne of EDC oxychlorination capacity ⁽³⁾
Copper	1 g/tonne of EDC oxychlorination capacity (only relevant for oxychlorination with fluidised bed) ⁽³⁾
<p>(1) Chlorinated hydrocarbons = VCM + EDC + chloromethanes + trichloroethane + other minor compounds. Analysis by chromatography, but reliable global parameters (AOX, EOX) can be used.</p> <p>(2) EDC purification capacity is used as a reference as the discharge mainly relates to EDC processing.</p> <p>(3) EDC oxychlorination capacity is used as a reference, because copper and dioxins primarily derive from the oxychlorination process.</p> <p>(4) VCM and chlorinated hydrocarbons values are before biological treatment. Other values are for final discharge.</p>	

Table 12.15: Performance of effluent treatment installations
[CEFIC, 2000 #105]

Sweden has reported that one of its installations was operating with a heavily loaded trickling filter which had problems reaching an effluent COD of 125 mg/l. The installation has recently built a new waste water treatment plant involving the following treatment stages. After pre-treatment the wastewater from the VCM and the PVC plants are mixed in a buffering tank, which is stirred and may be aerated, then pumped to an anaerobic selector stage for reduction of easily degradable components with minimal sludge formation. The following stage is a dual nitrification-de-nitrification stage in two coupled basins with alternating aeration, which serves to nitrify and denitrify the wastewater. This is followed by a separate final de-nitrification stage to which some untreated wastewater from the VCM unit is added as carbon source. A sedimentation stage follows, from which sludge is recirculated to the selector stage, and as a final treatment the outgoing water is polished by filtration. Final effluent from the plant is anticipated to contain 40 - 60 mg COD/l (based on calculation from TOC data). However, it should be noted that the biological de-nitrification stage is primarily justified by the PVC plant and stand-alone VCM units may not be able to reach the same emission level.

12.4.3.1 Monitoring

Inlet water to treatment plants is monitored in order to optimise the treatment plant performance. Continuous on-line monitoring for flow, pH and temperature is frequently applied. Treated effluent monitoring could include:

- continuous on-line monitoring of flow and pH
- continuous flow proportional sampling for solids, EDC, TOC, COD and Cu
- periodic sampling for VCM, dioxins, hexachlorobenzene, hexachlorobutadiene and other chlorinated organic compounds.

In addition, AOX (adsorbable organic halogenated compounds) or EOX (extractable organic halogenated compounds) may be used as control parameters.

Potentially contaminated water would often have continuous EDC monitors (with a detection limit of 1 mg/l EDC) and connection to an alarm.

12.4.4 By-products and wastes

The **by-products** (residues) from the EDC/VCM production process include light and heavy fractions/EDC tars from the purification units. These arisings can be minimised by:

- a high degree of EDC and VCM removal from the light and heavy fractions in the distillation train. The EDC and VCM is then recycled
- use of efficient catalysts in direct chlorination and oxychlorination
- hydrogenation of trace acetylene in HCl fed to oxychlorination.

The organic by-products can be re-used as follows:

- some of the light and heavy fractions can be used as feedstock for other chlorination processes, but this option is declining due to reduced production of chlorinated solvents
- recycling is applied on some plants where light and heavy fractions are combusted, the evolved hydrogen chloride being recycled to oxychlorination, while the combustion heat is recovered for steam production
- alternatively, the hydrogen chloride from combustion of the light and heavy fractions can be absorbed into water, leading to a commercial grade hydrochloric acid solution for internal use (e.g. effluent neutralisation, water demineralisation) or external sale.

When their re-use is not possible, the organic by-products are a waste and must be destroyed. This is carried out by on-site or off-site incineration, with heat recovery and neutralisation of the resulting hydrochloric acid. The incinerator can be fully dedicated to this stream, or accept other wastes, or process vents. The on-site combustion or incineration of the organic residues leads to aqueous and air emissions and these should meet the same release levels for process vent incineration. A liquid residues combustion unit or incineration of 10000 tonnes per year capacity for light and heavy fractions, including HCl recovery, excluding HCl neutralisation, is reported to cost 10 million Euro [CEFIC, 2000 #105].

By-product treatment techniques such as catalytic oxidation or hydrogenation are considered by some to be experimental and not proven [ECVM, 1994 #11]. However, catalytic oxidation by the 'Catoxid process' has been commercialised by B.F. Goodrich and produces an HCl stream for recycle to the oxychlorinator [Randall, 1994 #13].

The main process **wastes** that are regularly produced by EDC/VCM units are: sludge from waste water treatment; copper catalyst residues from fixed bed oxychlorination; and coke from EDC cracking. The coke from the cracking furnace is free of PCDD/F and is landfilled or incinerated. The other wastes are often contaminated by dioxins or furans and they are usually disposed-off by deposition in controlled chemical waste landfills; or destruction in chemical waste incinerators. Occasional wastes also arise when organic by-products cannot be recovered, or the hydrochloric acid solutions cannot be re-used or sold.

12.4.5 Costs of abatement

Abatement costs have been estimated for a plant producing 200 kt/yr VCM in a combined and balanced EDC/VCM process using oxygen-based oxychlorination [Environment Agency (E&W), 1998 #1]. The costing exercise considered the following techniques:

1. installation of high integrity equipment (e.g. seal-less pumps, valves with bellows) to control fugitive emissions. This is assumed to occur progressively, when substantial maintenance or renewal is undertaken, rather than as a forced retrofit. The cost estimate is a very approximate indicator of cost differential with conventional equipment
2. steam stripping of EDC from waste water and return to process
3. ducting of miscellaneous vents, such as from relief systems, to a vent gas incinerator

4. water treatment facilities including precipitation of copper compounds, conversion of difficult organics and the stripping of chlorinated decomposition products
5. high temperature incineration of liquid and tarry chlorinated organic wastes, with recovery and sale of hydrochloric acid. The waste incinerator and the vent incinerator are considered as two items, although combining them may be feasible.

Broad estimates of the costs of these techniques are shown in Table 12.16. In the context of VCM profitability, several of the abatement costs were considered as 'very significant' but were justified by the high environmental significance of pollutants such as VCM and dioxins. Other techniques, most notably high integrity equipment, provide good emission reductions at relatively low cost.

Technique	Capital cost (£000)	Operating cost (£000 pa)	Annualised cost (£000 pa)	Cost/tonne VCM (£)
1. Fugitives (equipment)	500	5	86	0.39
2. EDC stripping of waste water	500 ⁽¹⁾	209	290	1.32
3. Vents incinerator	2000		325	1.51
4. Other waste water treatment ⁽²⁾	1800	77	370	1.68
5. Organics incinerator	6000	-254	721	3.28

1. CEFIC quoted 3 million Euro for a stripping plant treating 40m³ per hour [CEFIC, 2000 #105].
 2. The scope includes precipitation of copper compounds, conversion of difficult organics and stripping of chlorinated decomposition products. It does not include steam stripping of EDC.

Table 12.16: Comparison of abatement costs for EDC/VCM production [Environment Agency (E&W), 1998 #1]

12.4.6 ECVM charter

The European Council of Vinyl Manufacturers (ECVM) represents most (11 out of 12) of the European EDC/VCM/PVC producers. In 1994, ECVM issued an industry charter [ECVM, #10] to improve environmental performance and introduce emission levels that were considered achievable on EDC/VCM units. The ECVM charter identifies techniques that represent good practice in the processing, handling, storage and transport of primary feedstocks and final products in VCM manufacture, namely:

"All recoverable quantities of VCM and ethylene dichloride (EDC) in waste streams from the production process are recovered and recycled into the process, as far as it is possible with reasonable efforts.

Residual levels of VCM and EDC in waste streams are treated by appropriate technology before these waste streams are discharged into the environment.

Control technology is implemented in VCM/EDC production to eliminate discharge of heavy metals and dioxin-like components to the extent that: effluent discharge does not result in exceeding established water quality standards, and contaminant levels in vent-gases do not exceed the European standard for waste incineration.

All significant outlets for vent-gases and effluent from the production process are kept under surveillance and valued, in order to determine the effectiveness of the control technology and to measure the final discharge of potential contaminants into the environment.

Fugitive emissions are reduced by installing leak-safe technology and by frequent inspections to check the integrity of all relevant sealings. This can be supported by installing fixed monitoring systems for measuring VCM/EDC concentration.

Liquid chlorinated organic by-products from the production process, if not recycled as feedstock for other chlorination processes, are destroyed with recovery of chlorine in the form of HCl."

The Charter also contains environmental standards for air and water emissions from EDC and VCM production which are reproduced in Table 12.17. A 1999 survey of compliance with the emission figures showed that 64 % of ECVM plants complied with all requirements of the charter [CEFIC, 1999 #70].

Substance (units)	Emission limits	
	All vent gases	Total of aqueous effluents
VCM	5 mg/Nm ³	-
EDC	5 mg/Nm ³	5 g/t EDC purification capacity ¹
HCl	30 mg/Nm ³	-
Ethylene	150 mg/Nm ³	-
Dioxin-like components	0.1 ng TEQ /Nm ³	1 µg TEQ/t oxychlorination capacity
Copper		1 g/t oxychlorination capacity ²

Note 1: For a balanced VCM unit, the EDC purification capacity is about 3 times larger than the VCM capacity
Note 2: For a balanced VCM unit, the oxychlorination capacity is about 80 % of the VCM capacity.

Table 12.17: ECVM emission limit values for air and water
[ECVM, #10]

12.4.7 OSPAR

The Oslo and Paris Commission have issued Decision 98/4 [OSPAR, 1998 #79] on achievable emission levels from EDC/VCM manufacture (Table 12.18). The decision contains ELVs which have been derived from a BAT technical document [PARCOM, 1996 #22] and a BAT Recommendation [PARCOM, 1996 #21]. OSPAR contracting parties who have endorsed the decision, subsequently have an obligation to implement the decision including the ELVs in their national legislation. The decision applies for new plants from 9 February 1999 and existing plants should comply with the decision from 1 January 2006. Most of the West European EDC/VCM plants listed in Table 12.1, except for the plants in Italy and some plants in France which are outside the OSPAR catchment area, are subjected to Decision 98/4.

Substance	Emission limit values (annual averages)	
	Air ⁽¹⁾	Water
VCM	5 mg/Nm ³	0.1 mg/l
EDC	5 mg/Nm ³	5 g/t EDC purification capacity or 2.5 mg/l
Chlorinated hydrocarbons ⁽²⁾	-	0.7 g/t EDC purification capacity (after stripper, before secondary treatment)
Copper (total)	-	1 g/t oxychlorination capacity (fluidised bed reactor) (after final treatment) 0.5 g/t oxychlorination capacity (fixed bed reactor) (after final treatment)
Dioxins	0.1 ng/Nm ³	1 µg TEQ/t oxychlorination capacity (after final treatment)
HCl	30 mg/Nm ³	-
COD		250 mg/litre (after final treatment) or 90 % reduction

Note 1: Standardised at conditions of: temperature 273 K, pressure 101.3 kPa and 11 % oxygen dry gas
Note 2: Chlorinated hydrocarbons = VCM + EDC + chloromethanes + trichloroethane + other minor compounds as analysed by chromatography, but reliable global parameters (AOX – EOX) can also be used.

Table 12.18: OSPAR emission limit values for air and water
[OSPAR, 1998 #79] [PARCOM, 1996 #22]

PARCOM reports that some plants have considerably lower discharges and these are summarised in Table 12.19.

Component	Concentration	Comment
Total chlorinated hydrocarbons	< 1 mg/l	After stripper, before bio-treatment
Dioxins	< 0.1 ng/l	Final discharge
Sum of hexachlorobenzene and pentachlorobenzene	< 1 µg/l	Final discharge
Hexchlorobutadiene	< 1 µg/l	Final discharge
Copper (total)	< 1 mg/l	Final discharge
COD	< 125 mg/l	Final discharge

Table 12.19: Reported achievable concentrations in effluents from some plants
[PARCOM, 1996 #22]

12.5 Best Available Techniques

As explained in Chapter 6, BAT for a particular LVOC process is determined by considering the three levels of BAT in the following order of precedence: illustrative process BAT (where it exists); LVOC Generic BAT; and finally any relevant Horizontal BAT. The following techniques are BAT for the illustrative process of EDC/VCM production.

12.5.1 Process selection

The BAT route for the production of EDC and VCM is via the chlorination of ethylene. The chlorination of ethylene can be carried out by 'direct chlorination' or 'oxychlorination', each route having its advantages and providing complementary components of the balanced EDC/VCM process, and so it is not possible to identify which one is BAT.

The balanced process is the common reference used to benchmark the performances of EDC/VCM units that, for local reasons, have imports and/or exports of EDC and/or hydrochloric acid. BAT is to optimise the process balancing so as to maximise the recycle of process streams. Where local circumstances do not permit full process balancing, attention is to be paid to optimising the sources and sinks of EDC/HCl.

When considering the direct chlorination of ethylene, both the low-temperature and high-temperature variants (above the EDC boiling point) are BAT for new units. For existing 'cold' chlorination units the retrofitting of high temperature units is probably not justified.

In the ethylene oxychlorination step, there are choices between the source of oxidant (air or oxygen) and the reactor type (fixed or fluidised bed).

- **Source of oxidant:** The use of oxygen is considered to be BAT for new plants, provided that there is an economically available source of oxygen. For an air-based unit, the retrofitting of oxygen may be justified by site specific, economic reasons (e.g. an increase in production capacity, limited capacity of a site incinerator).
- **Reactor type:** Fixed bed and fluid bed reactors may both be BAT.

The choice of chlorine source is very dependent on local circumstances. Liquid chlorine results in lower air emissions, but there may be significant commercial and environmental advantages in using tail gas chlorine in a co-located plant.

12.5.2 Plant design

Vent connection. BAT is to connect the vents from normal operation (that contain chlorinated hydrocarbons and/or ethylene or other organics) to a recovery system or to vent gas treatment if their concentrations exceed:

VCM	5 mg/Nm ³
EDC	5 mg/Nm ³
Ethylene	150 mg/Nm ³
HCl calculated as total chloride	30 mg/Nm ³
Chlorine	5 mg/Nm ³
Dioxin iTEQ	0.1 ng/Nm ³

Where the mass emission of chlorinated hydrocarbons is below 0.025 kg/h and below 2 kg/h for ethylene, the environmental benefits of connection may not be justified by the costs.

Storage. BAT for storage and handling facilities is:

- tank vents passing to the thermal / catalytic oxidiser
- the loading of VCM, EDC and by-products into trucks, railcars or ships that are equipped with a vapour return system on their tanks.

In particular cases, where lower emissions are desirable, then BAT may also involve the activated carbon adsorption of low-flow vents (e.g. the loading of EDC into transport vessels).

Reduction of chlorinated by-product formation. BAT for reduction of the chlorinated by-products is the use of such techniques as:

- hydrogenation of the acetylene contaminant in HCl produced in the EDC cracking plant and recycling to oxychlorination. By effecting this hydrogenation it is possible to avoid the formation of dichloroethylenes, trichloroethylenes, tetrachloroethane and tetrachloroethylene. Without the trichloroethylene it is possible to carry out the distillation of the light ends, increasing in this way the EDC recovery
- complete recycle of the raw materials and reaction intermediates. The ethyl chloride can be separated from the lights and recycled to the oxychlorination section; the ethylene contained in the purge gas can be converted in EDC in specific reactors
- use of burners with flat flame in the cracking furnaces. The use of these burners allows to reduce the hot spots on the walls of the process tubes and consequently the production of by-products due to the high temperatures.

Heat recovery from cracking furnaces. The recovery of the heat in the process gas leaving the cracking furnace could be used to vaporise the EDC feed to the furnace or to generate steam depending on the energy situation of the plant. The recovery allows reduction of prime energy consumption either by vaporisation of the cracker EDC feed or by production of steam to be used elsewhere in the process. Both alternatives reducing subsequently the total emission of CO₂ and NO_x from the production site.

12.5.3 Treatment of air pollutants

Recovery. BAT for the recovery of ethylene, EDC, VCM and other chlorinated organic compounds is:

- recycling directly to the process
- refrigeration and condensation
- absorption in solvents followed by stripping; or
- adsorption on solids followed by desorption.

These techniques are BAT for the following sources (vents):

- direct chlorination reactor
- oxychlorination reactor
- distillation columns and dryers for by-products including light-and heavy-ends
- VCM/EDC separation
- VCM purification
- vacuum pumps
- sampling systems
- tanks and pipelines for EDC, VCM and by-products
- contaminated waste water collection and treatment system.

Treatment. BAT is to use efficient combustion techniques (either thermal or catalytic) to further reduce the off-gas concentrations of chlorinated compounds and ethylene, and to recover energy as steam. The BAT will depend on the content of chlorinated organic compounds in the vent gases:

- for VOCs in the ‘several hundreds’ of ppm range - catalytic (flameless) combustion at 500 - 600 °C with little or no fuel gas consumption
- for VOC in the ‘thousands’ of ppm range – thermal oxidation at more than 750 °C with rapid quenching through the temperature window for *de novo* PCDD/F formation.

BAT is to combust all vents, except those that pose unacceptable explosive risks and those with such a large flow that they would overload the treatment system. Such combustion will normally invoke some of the requirements of the EC directive on the incineration of waste (2000/76/EC) even though the directive is not directly applicable to gaseous wastes. The oxidiser may be followed by activated carbon adsorption if dioxin levels are high.

BAT for the HCl formed from the combustion of chlorinated organic compounds is absorption in water/hydrochloric acid for recovery, and/or an alkaline solution. This combination of techniques can achieve the following emission concentrations (as daily averages)[PARCOM, 1996 #22]:

Sum of EDC and VCM from point sources:	<1 mg/Nm ³
Dioxin from point sources (I-TEQ):	< 0.1 ng/Nm ³
HCl from point sources:	<10 mg/Nm ³

In particular cases (e.g. where incineration does not achieve the dioxin levels, or where lower dioxin emissions are desirable) then activated carbon adsorption of incinerator off-gases may be BAT.

Fugitives. BAT for fugitives is described in Section 6.3 and can achieve the following fugitive release levels:

Volatile chlorinated hydrocarbons from fugitive sources:	< 5 kg/h
EDC in working atmosphere:	< 2 ppm (8 mg/Nm ³)
VCM in working atmosphere:	<1 ppm (2.6 mg/Nm ³)

Monitoring. BAT for the monitoring of stack emissions is continuous on-line instrumental monitoring of O₂ and CO and sampling at intervals for C₂H₄, VCM, EDC, Cl₂, HCl and Dioxin. BAT for the monitoring of installation ambient air is:

- continuous, on-line instrumental monitoring of VCM and EDC at a number of appropriate points in the plant airspace
- spot checks of VCM and EDC with hand held instruments, to detect leaks
- personal monitors for VCM.

12.5.4 Treatment of water pollutants

BAT is treatment of effluent streams arising from:

- reaction water from oxychlorination
- wash water and condensate from EDC purification
- other condensates
- water seal flushes from pumps, vacuum pumps
- cleaning water from maintenance operations
- water separated in wet EDC and light-end storage tanks.

12.5.4.1 Pre-treatment

BAT for chlorinated organic compounds that are dissolved in waste water (e.g. EDC, VCM, chloroform, carbon tetrachloride) is steam, or hot air, stripping to effluent concentrations of less than 1 mg/l. BAT for the stripped material (EDC, VCM etc.) is condensation and recovery, or incineration.

BAT for any semi-volatile or non-volatile chlorinated organic compounds that are adsorbed on particulate matter is removal by flocculation, settling and filtration.

The BAT effluent concentration for copper is less than 1 mg/l. This is achieved by alkaline precipitation and separation by settling or, where the effluent contains ammonia, by electrolysis.

12.5.4.2 Final treatment

BAT for the pre-treated effluent is discharge to biological treatment that can achieve the following maximum effluent concentrations:

Total chlorinated hydrocarbons:	1 mg/litre	Copper (total):	1 mg/litre
Dioxins (iTEQ):	0.1 ng/litre	COD:	125 mg/litre
Sum of hexachlorobenzene and pentachlorobenzene	1 µg/l	Hexachlorobutadiene:	1 µg/l

On the basis of new data for a dual nitrification-de-nitrification waste water treatment plant, the BAT-associated emission is 50 to 100 mg COD/l. However, this treatment technique is probably not BAT for a EDC/VCM unit that stands isolated from PVC production.

On sites where these concentrations cannot be achieved by biological treatment alone, or where there are site-specific reasons for lower emissions, then BAT may, in addition, be:

- micro-filtration by membrane filter for particles down to 0.5 µm
- adsorption of dissolved chlorinated organic compounds on activated carbon fixed bed filters.

BAT for monitoring of the treated effluent is:

- continuous on-line monitoring of flow and pH
- continuous flow proportional sampling for solids, EDC, an organic pollution parameter (for example TOC, COD or BOD) and copper
- periodic sampling for VCM, dioxins, and other chlorinated organic compounds
- continuous EDC monitors on potentially contaminated water outlets (with detection limit 1 mg EDC/l and connection to an alarm system).

12.5.5 By-products (residues)

The first component of BAT is the minimisation of by-products through the choice of catalysts and operating conditions. BAT also involves maximising the re-use of by-products as feedstock for manufacturing other organic chlorinated compounds (e.g. perchloroethylene) and, when re-use or recovery is not feasible, incinerating any remaining by-products (with recovery of heat and recycling or re-use of the hydrochloric acid). BAT for the incinerator is design according to the Directive on the incineration of waste (2000/76/EC).

12.5.6 Wastes

The first component of BAT is waste minimisation and recycling to the process. BAT for sludge from waste water treatment and coke from EDC cracking is incineration in a dedicated or multi-purpose hazardous waste incinerator that is designed according to the Directive on the incineration of waste (2000/76/EC). If the waste has a small content of organo-halogenated compounds (typically less than 1000 mg/kg dry matter) then BAT may also be disposal to a chemical waste landfill.

12.6 Emerging techniques

12.6.1 Ethylene based production processes

Future production developments are likely to concentrate on eliminating the multiple stages of combined processes (i.e. chlorination, oxychlorination, pyrolysis) as these entail considerable capital and process costs [Weissermel & Arpe, 1993 #59] [Ullmann, 1998 #80]. The direct chlorination or oxychlorination of ethylene to VCM could achieve a major simplification in VCM manufacture. Numerous patents exist, using noble metal catalysts, but none have reached industrial scale due to the high temperatures needed and the consequent side reactions. Direct chlorination with other catalysts may reduce the formation of chlorinated by-products but this is the subject of continuous research and development [CEFIC, 2000 #105].

The Monsanto Kellogg VCM process completely eliminates the oxychlorination step of the balanced process and this makes the plants, simpler, smaller and more [HMIP UK, 1992 #121]. Emissions to all media are reduced because only direct chlorination is used. The main process steps are:

- direct chlorination of ethylene to EDC
- EDC pyrolysis to VCM and recovery of HCl
- VCM purification and EDC recovery
- EDC purification and heavy ends removal
- HCl oxidation to chlorine by the Kel-Chlor process.

12.6.1.1 EDC via gas phase direct chlorination of ethylene

EVC are developing the gas phase direct chlorination of ethylene. The development of the process is at a pilot plant scale and the technology could be available by 2003 if the results are positive. The process shows the following advantages compared to the best technology of the liquid phase direct chlorination:

- it allows the heat produced by the reaction to be recovered at a higher thermal level (200 - 250 °C compared to 100 - 120 °C in the standard technology) increasing the overall energy efficiency of the EDC/VCM production cycle
- it increases the reaction selectivity giving an ethylene yield to EDC close to 99.9 % and avoiding the formation of heavy chlorinated by-products formed in the standard technology.

12.6.1.2 Production of VCM via catalytic cracking of EDC

The catalytic cracking of EDC allows the dehydrochlorination of EDC to VCM at lower temperatures (compared to thermal cracking) and does not need furnaces using flames. A further energy saving is the possibility to obtain high conversion for passage of EDC and consequently a drastic reduction of energy consumption due to the distillation and the recovery of the unconverted EDC. The process has a high selectivity to VCM and it is possible to avoid the production of heavy chlorinated by-products. The acetylene by-product can be recycled to

the oxychlorination process after the hydrogenation to ethylene. A fundamental process advantage is the possibility to feed raw EDC (ex-oxychlorination) to the reactor after elimination of humidity. Process development is at the laboratory scale and could be commercially available by 2005 if the results are positive [EVC Italia SpA, 2000 #124].

12.6.1.3 Simplified process for the VCM production

The above developments, together with new oxychlorination technologies that produce high purity EDC (>99 %), allow the development and planning of a simplified VCM production process where the role of the distillation sections (and hence energy consumption) is drastically reduced. In this simplified process the EDC produced via oxychlorination is treated to remove the water and then sent directly to catalytic cracking. The EDC produced by gas phase direct chlorination is also sent directly to catalytic cracking. In the cracking section, the high conversion per passage (about 95 %) is sufficient to separate the HCl from the VCM and the small amount of EDC in only one column, recycling the unconverted EDC to the cracking reactor. From this last flow it is possible to purge to avoid the increase of heavy substances in the cycle. This enables the use of only two distillation columns (one for the dehumidification) instead of the 5 - 6 columns required in the present technology. At present there is a modelling study of the overall process and the technology could be available after 2005 [EVC Italia SpA, 2000 #124].

12.6.2 Ethane based production processes

Production routes based on the direct chlorination or oxychlorination of ethane have been developed to utilise the ready availability of this feedstock and to avoid the costly intermediate step of converting ethane to ethylene [Wells, 1991 #60]. Progression beyond the current experimental stage depends on solutions to the problems of catalyst selectivity, turnover and long-term performance [Ullmann, 1998 #80]. One example is the Lummus-Armstrong Transcat process [HMIP UK, 1992 #121] [Ullmann, 1998 #80].

EVC reports the development of a process for the direct production of EDC or VCM from Ethane. The process is currently a semi-tech industrial plant and the first industrial plant is foreseen by 2005. The process has the following characteristics [EVC Italia SpA, 2000 #124]:

- 30 % reduction in energy consumption by avoiding the use of ethylene as raw material
- the chlorinated by-products after a specific treatment are recycled inside the process, giving a low amount of by-products to incinerate.

As liquid EDC (which is easy and safety to handle) can be produced where ethane is available and then supplied to plants based on the standard cracking technology, this replaces the units for the direct chlorination of ethylene. Thus the advantages coming from the use of ethane can be included, at least partially, in the plants based on the standard technology. These plants would work with half feed based on ethylene and the other half feed based on ethane. This exploits, in half amount, the advantages described above.

12.6.3 Other developments

There are two processes for the recovery of VCM from trichloroethanes, either by direct catalytic dehydrochlorination or by catalytic dechlorination with ethylene, but this route alone could not satisfy the large VCM demand [Wells, 1991 #60].

Research has been carried out on photochemically induced dehydroxychlorination of EDC using light from mercury, thallium or tungsten lamps, or from lasers [Wells, 1991 #60]. Despite considerable improvements in conversion and product quality, it is not proven on an industrial scale [Ullmann, 1998 #80].

There are reports [Noyes, 1993 #120] [Randall, 1994 #13] that, in 1993, a laser-induced cracking technique was “under development” in Germany with the aim of reducing by-product formation from the **pyrolysis** reaction.

13 ILLUSTRATIVE PROCESS: TOLUENE DIISOCYANATE

13.1 General information

Isocyanates, especially toluene diisocyanate (TDI) and diphenyl methane diisocyanate (MDI), are commercially important in the production of polyurethane resins. Isocyanate production is by the reaction of the corresponding amine with phosgene in a solvent. The choice of reaction conditions is important because of the reactivity of isocyanate groups and the possibility of side reactions. TDI is an ester of isocyanic acid, characterised by the formula $\text{Ar}-\text{CH}_2(\text{NCO})_2$. Pure TDI, or as a mixture of 2,4- and 2,6-TDI, is used for the production of flexible foams, plastics or paints based on polyurethane for furniture, cars and consumer products.

In 1991 the world-wide TDI production capacity was estimated at 940 kt / year [Weissermel & Arpe, 1993 #59]. The 2001 European production capacity is shown in Table 13.1.

Producer	Site	Country	Production capacity (kt/yr)
Bayer	Dormagen	Germany	80
Bayer	Brunsbüttel	Germany	80
Bayer	Leverkusen	Germany	50
BASF	Schwarzheide	Germany	70
Bayer-Shell	Antwerp	Belgium	30
DOW	Porto Marghera	Italy	110
Rhodia	La Madeleine and Pont de Claix	France	120
Total			540

Table 13.1: European producers of TDI in 1998

Based on [UBA (Germany), 2000 #92]

13.2 Applied processes and techniques

Aromatic isocyanates are produced in highly integrated production sites and this typically includes integrated phosgene production. All TDI is manufactured from toluene by the phosgene route [Wells, 1991 #60]. This continuous process involves three steps [UBA (Germany), 2000 #92]:

1. nitration of toluene
2. hydrogenation of dinitrotoluene to toluene diamine
3. phosgenation of toluene diamine to toluene diisocyanate.

The chemical reaction sequence from toluene to TDI is shown in Figure 13.1 and a block diagram for this sequence is given in Figure 13.2. Most often, all process steps are located on the same site. Some TDI plants may be interconnected with plants for the production of TDI intermediates or plants for the purification of acids.

13.2.1 Nitration

Step 1 is a liquid organic/aqueous phase reaction. In a continuous, two-step process toluene reacts at 45 - 70 °C with nitrating acid (a mixture of sulphuric acid, nitric acid and water). This forms, as main products, a mixture of 2,4- and 2,6-dinitrotoluenes, with by-products such as the 2,3 and 3,4 isomers. The reaction product is separated from the used acid in a phase separator. The used acid is purified and concentrated for re-use. The mixture of dinitrotoluenes is processed in an alkaline scrubber using water, or sodium carbonate solution and further fresh water, and further purified by crystallisation. The technical grade mixture of dinitrotoluenes is purified by alkaline wash without any further crystallisation.

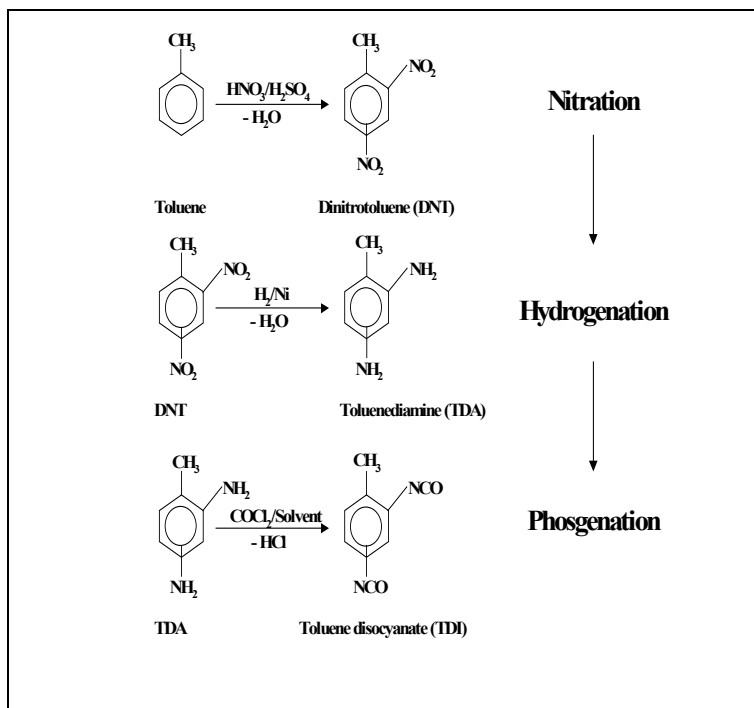

Figure 13.1: The chemistry of TDI production
[UBA (Germany), 2000 #92]

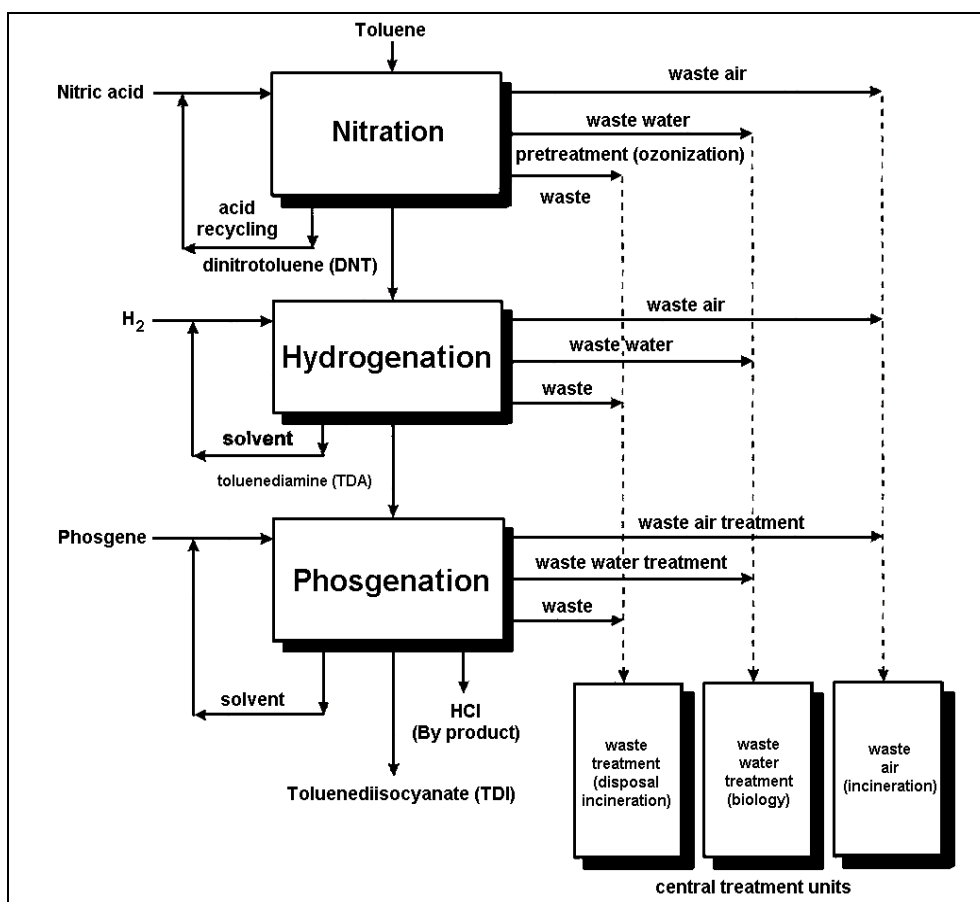

Figure 13.2: A schematic TDI production sequence
[UBA (Germany), 2000 #92]

Figure 13.3 shows the waste gas and waste water streams from the nitration process.

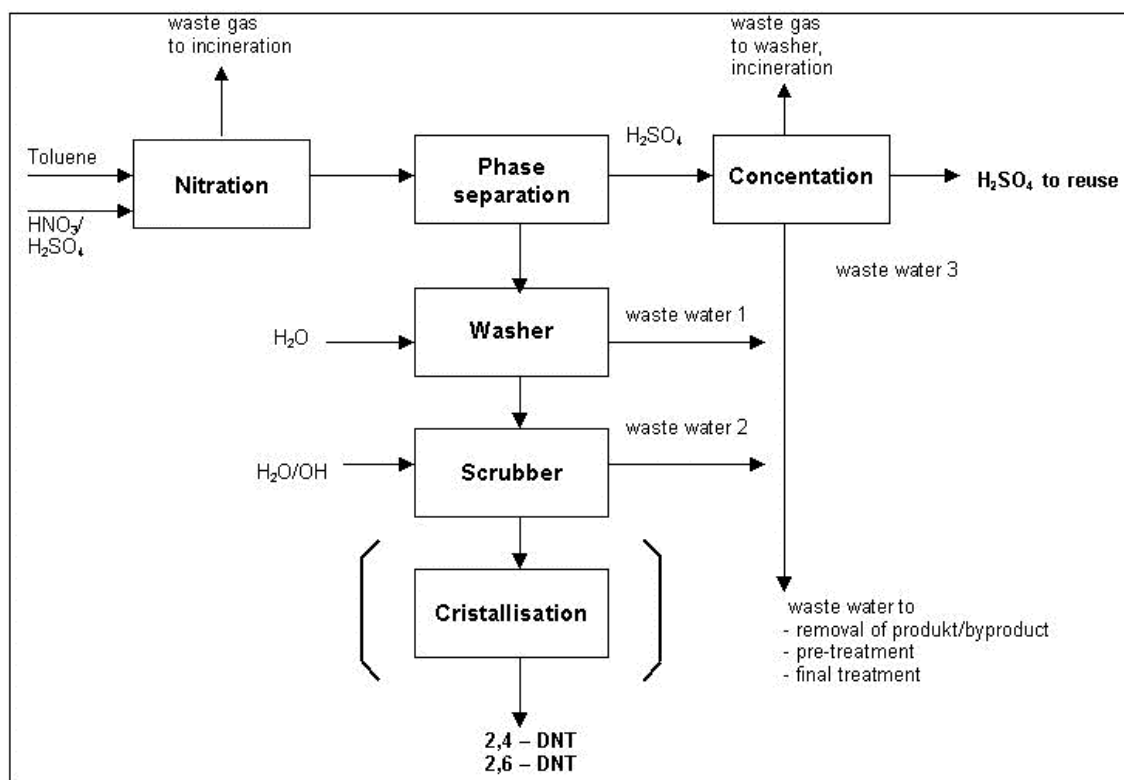

Figure 13.3: Waste gas and waste water from the manufacture of DNT
{UBA (Germany), 2001}

13.2.2 Hydrogenation

Step 2 is a catalytic exothermic gas/liquid/solid phase reaction. Dinitrotoluene is reduced to toluene-diamine (TDA) by a continuous, one or more stage, hydrogenation process with metal catalysts, with or without organic solvents (e.g. alcohol) and reaction temperatures up to 200 °C and pressures up to 8000 kPa. If a two stage process is applied the second hydrogenation stage may operate at lower pressure and without solvent as metal catalysts (e.g. Raney-nickel or palladium) may be used. A side reaction may lead to formation of traces of ammonia and toluidines. Isopropanol, when used in the reaction mixture, reacts with the ammonia to form isopropylamine [HMIP UK, 1995 #73].

The reaction product is separated in a TDA rich product stream, cleaned from the residual catalyst by filtration or centrifugation, followed by a distillation to recycle the solvent (if used). In the next distillation units, the TDA is de-watered and rectified to a mixture of 2,4- and 2,6 TDA. A higher boiling residue may be separated and remains for disposal.

Figure 13.4 shows the waste gas and waste water streams from the hydrogenation process.

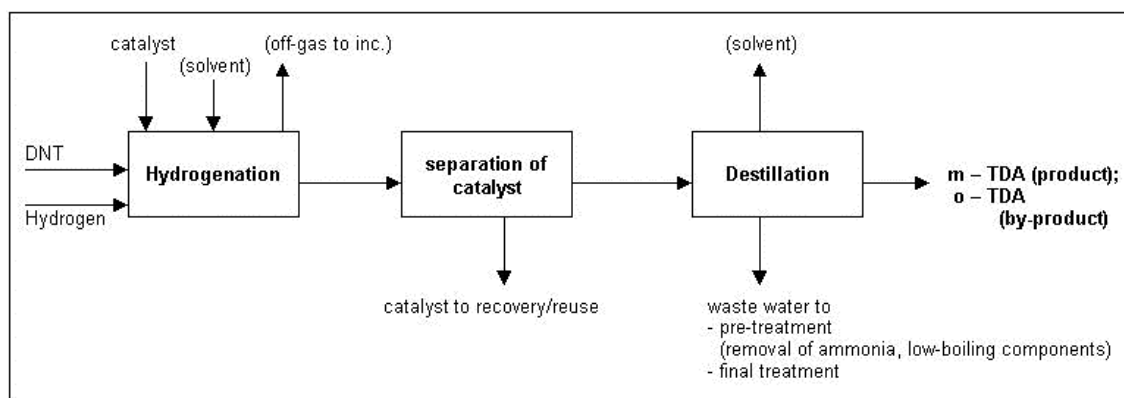

Figure 13.4: Waste gas and waste water from the manufacture of TDA
{UBA(Germany), 2001}

13.2.3 Phosgenation

Phosgenation in the context of TDI production is always an integrated route including installations for the manufacture of phosgene. This should not to be confused with stand-alone phosgene production units which fall under the Inorganic Chemical BREFs. The process for phosgene production, which is not covered here, involves the exothermic, gas phase, catalytic reaction between chlorine and carbon monoxide. Several other process routes are operated.

Toluene diisocyanate (TDI) is always produced by the reaction of phosgene with TDA in a cascade of reactors. Generally a 25 - 50 % solution of phosgene or pure phosgene is added to a 10 - 20 % solution of TDA in an inert organic solvent (such as o-di-chlorobenzene). In the first reaction ('cold' phosgenation) stage TDA reacts at low temperatures with phosgene. Efficient mixing is achieved by high turbulence and possibly by re-circulation. The resulting slurry of carbamyl chlorides and amine hydrochlorides is heated in the 'hot' reaction stage with excess phosgene until a clear solution of TDI is obtained.

The by-product hydrogen chloride and excess phosgene are vented at high temperature to prevent recombination of hydrogen chloride with TDI. Hydrogen chloride and phosgene are recovered. The purified hydrogen chloride may be marketed or oxidised to chloride by electrolysis for re-use in the phosgene production step. For process reasons (amongst others, prevention of the formation of toxic hexa-chlorobenzene) HCl sent to electrolysis must be free of o-di-chlorobenzene. TDI is purified by fractional distillation. The recovered solvent can be recycled. The distillation residues need to be disposed off. The waste gas, maybe containing some phosgene, is fed to a waste gas treatment facility (e.g. hydrolysis in a scrubber with water or NaOH giving 99.9 % removal efficiency). Organic effluents from scrubber vents may be delivered to incineration to destroy any trace of organic solvent or may be adsorbed on activated carbon. Waste gas from the first reaction stage is flared.

Figure 13.5 shows the waste gas and waste water streams from the phosgenation step.

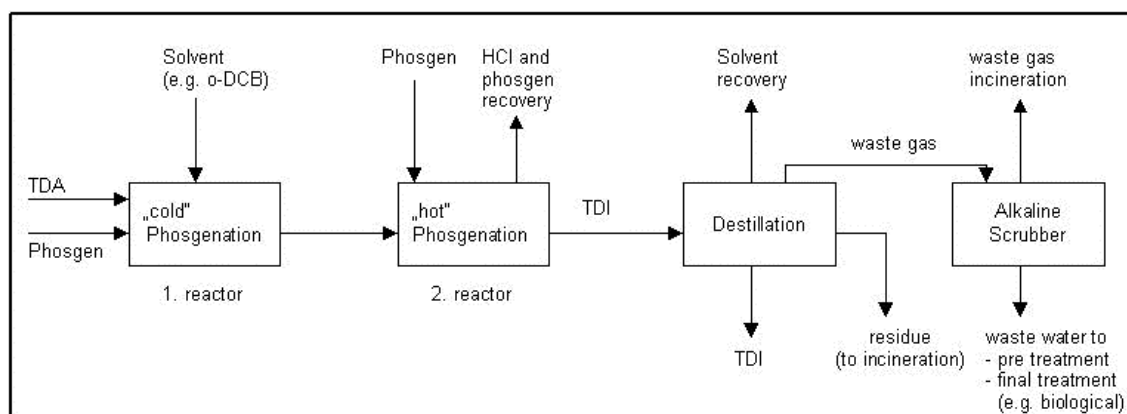

Figure 13.5: Waste gas and waster water from the manufacture of TDI
{UBA (Germany) 2001}

13.2.4 Process variants and alternatives

At an R & D scale TDI has been produced by the phosgenation of toluenediamine hydrochlorides. For example, in the Mitsubishi Chemical process toluenediamines are dissolved in o-dichlorobenzene and converted into a salt suspension by injecting dry HCl. Phosgene is then reacted with the hydrochlorides at elevated temperatures and with strong agitation to give the diisocyanates. Evolved HCl is removed with an inert gas stream. Work-up and purification is by fractional distillation. The selectivity to TDI may be up to 97 % (based on diamine) and the overall selectivity to diisocyanate may be 81 % (based on toluene) [Weissermel & Arpe, 1993 #59].

TDI may be produced directly from dinitrotoluene by liquid phase carbonylation with o-dichlorobenzene. The major advantage of this route is that it avoids the use of phosgene (undesirable because of its volatility and toxicity) as well as the waste recovery problems associated with hydrochloric acid. Mitsui Toatsu and Mitsubishi Chemical have patent technologies for this route [Weissermel & Arpe, 1993 #59].

One-step reactions have been developed based on the reaction between dinitrotoluene and carbon monoxide, but were abandoned due to the severe reaction conditions. These have been replaced by two-step routes using selenium catalysts [Wells, 1991 #60].

13.3 Consumption and emission levels

Note: The illustrative process for the production of TDI has not benefited from the European overview that CEFIC have been able to contribute for other illustrative processes in this document. The data on consumption and emission levels rely heavily on submissions from Germany.

There are a few 'global players' which produce most of the world TDI (e.g. BASF, Bayer, Dow, Huntsman). Even a small edge of know-how can give economic advantage so detailed information about solvents, process engineering and cost are often classified as company secrets and cannot be published. Because of this, there is only a small pool of data available to the information exchange and generalisations have to be made with caution.

13.3.1 Consumption levels

One tonne of TDI product requires 875 kg of toluene diamine and 1420 kg of phosgene. This represents, for the o- and p-isomers, a yield of 85 % [Wells, 1991 #60]. The yield of the intermediate processes is about 97 % DNT and 92 % TDA with respect to toluene. 95 % of the sulphuric acid is recovered and re-used in the process [UBA (Germany), 2000 #143].

13.3.2 Air emissions

Two different ways to abate air emissions can be found:

- decomposition of VOC and NO_x in central incineration units (thermal and/or catalytic)
- selective, non-central absorption or adsorption measures.

The following data are all from German plants. The data are based on plant boundaries that exclude the manufacture of hydrogen and chlorine but include the recovery of sulphuric and nitric acid. All emission concentration values are half-hour averages.

13.3.2.1 Emission from central incineration

Some German plants [UBA (Germany), 2000 #143] decompose the waste gases by incineration and/or co-incineration e.g. in the sulphuric acid re-use unit. The emissions are not specific for TDI production because of fuel gas addition to the waste gases incinerator. No results of emission measurements are reported but ranges of permit data:

Nitration unit:

C_{total} (3 - 36 mg/m³), CO (24-132 mg/m³), NO_x (12 - 250 mg/m³), SO₂ (20 mg/m³)

Phosgenation unit:

C_{total} (2 - 20 mg/m³), HCl (30 mg/m³), dust (11 mg/m³), SO₂ (20 - 250 mg/m³)

One company reported that co-incineration yields higher emissions than adapted incineration.

13.3.2.2 Emissions from non-central purification

One plant is recorded as having the following emissions [UBA (Germany), 2000 #92]:

Nitration unit:

Nitro toluene (0.7 mg/m³), toluene (45 mg/m³), NO_x (109 mg/m³).

Absorption with partial oxidation is used to oxidise nitrogen oxides and VOC. The VOC emissions are reduced by 99.8 %. Oxidation of NO_x and dissolving in water gives nitric acid which can be re-used. The waste gases can be redirected to a combustion system because the absorption/oxidation unit is sensitive to troubles.

Hydrogenation unit:

After scrubber: solvent (12 mg/m³), TDA (4 mg/m³), NH₃ (7 mg/m³).

Small amounts of hydrogen containing waste gases are reduced in a flare.

Phosgenation unit:

After scrubber: solvent (27 mg/m³), TDA (4 mg/m³), phosgene (< 0.01 mg/m³).

Waste gases with low concentrations of diisocyanates can be treated by scrubbing with water (achievable concentration <5 mg/m³ diisocyanate) but no reasonable data are known. Small amounts of carbon monoxide containing waste gases are oxidised in a flare.

13.3.3 Water emissions

Waste water raisings from the **nitration unit** derive from the reaction ($0.2 \text{ m}^3/\text{t DNT}$), from the nitric acid used ($0.37 \text{ m}^3/\text{t DNT}$ using 65 % HNO_3 , $<0.01 \text{ m}^3/\text{t DNT}$ using 99 % HNO_3) and from washing the product. Waste water is released at the concentration / recovery of the sulphuric acid and at the washers. Main components are the organic products and by-products, namely di- and trinitrocresols, nitrate/nitrites and sulphates. The organic load is toxic and poorly biodegradable. At a German plant this results in an effluent stream of $1.3 \text{ m}^3/\text{t}$ and $4 \text{ kg COD}/\text{t product DNT}$. Measured toxicity (luminescent bacteria) was in the range of $\text{LID} = 600 - 800$. At another, older German plant the effluent stream after pre-treatment (extraction) is $1 \text{ m}^3/\text{t}$ with $\text{COD } 4 \text{ kg}/\text{t DNT}$, $\text{TOC } 1 \text{ kg}/\text{t DNT}$, $\text{nitrate } 14 \text{ kg}/\text{t DNT}$, $\text{nitrite } 10 \text{ kg}/\text{t DNT}$ and $\text{sulphate } 23 \text{ kg}/\text{t DNT}$. Re-engineering of the process may raise process efficiency and lead to almost complete reduction of nitrite and a certain reduction of sulphate and nitrate [UBA (Germany), 2000 #143] [UBA (Germany), 2000 #92]. If highly concentrated nitric acid is used, the amount of waste water per product is considerably lower.

The hydrogenation and phosgenation units produce waste water from the production process and from cleaning operations. However, the pollutant load is much lower than that arising from the nitration unit.

In the **hydrogenation unit** waste water results from the reaction ($0.6 \text{ m}^3/\text{t TDA}$) and from product purification. In a German plant, the pre-treatment and re-use of waste water (by removal of ammonia and low-boiling organic compounds) reduced by 50 % the waste water from hydrogenation (remaining waste water volume of $0.7 \text{ m}^3/\text{t TDA}$). Besides TDA, waste water contains ammonia, aminotoluene and hexahydroptoluidene [UBA (Germany), 2000 #143].

In the **phosgenation unit** the amount of waste water at one German plant is about $8 \text{ m}^3/\text{t TDI}$ and contains $\text{TOC } <0.4 \text{ kg}/\text{t TDI}$ prior to biological treatment. Unlike DNT and TDA, TDI in waste water hydrolyses and decomposes to insoluble ureas and carbon dioxide. TDI storage vessels may generate water emissions from the same sources as for air emissions (see above).

Specific emission values for waste water from a German nitration and hydrogenation unit are given in Table 13.2.

		Total process ⁽²⁾	Manufacture of:		
			TDI only ^(1, 4)	TDA	DNT
		per tonne of TDI	Per tonne of TDI	per tonne of TDA	per tonne of DNT
Amount of waste water	m^3/t	6	4.4	0.7	0.9
COD	kg/t	6	1.3	1.0	4.6
TOC	kg/t	2	0.4	0.3	1.2
Nitrate	kg/t	15			20
Nitrite ⁽³⁾	kg/t	10			14
Sulphate	kg/t	24			33

1. At other sites waste water emissions approach zero by replacing wet waste gas treatment with incineration
 2. At other sites waste water emissions are reduced by replacing wet waste gas treatment with incineration
 3. Nitrite emissions are avoided at other sites by in-process measures
 4. Including waste water from storage tanks

Table 13.2: Specific emission from the TDI process prior to biological treatment From Germany (Comment D 101 on first draft)

Referring to the data in Table 13.2, emissions after bio-treatment (including nitrification / denitrification) for the whole process are $\text{TOC } <0.4 \text{ kg}/\text{t TDI}$ and $\text{TNb (total nitrogen)} < 0.2 \text{ kg}/\text{t}$.

13.3.4 Wastes

The hydrogenation stage produces distillation residues and spent catalysts. The use of concentrated sulphuric acid may generate corrosion products based on iron sulphate. The phosgenation unit produces distillation residues, contaminated solvents and activated carbon that have to be disposed mainly in an incineration plant.

On a German plant [UBA (Germany), 2000 #92] the hydrogenation unit produces 0.03 tonne wastes/t TDA (for incineration). The phosgenation unit produces 0.05 tonne wastes/t TDI (for incineration). Waste volumes depend on the TDI unit as well as on the ability of the site incineration unit to handle a high-viscosity waste feed.

13.4 Techniques to consider in the determination of BAT

13.4.1 Process design

13.4.1.1 Process route

All TDI plants in the world use the phosgene process with the nitration of toluene, followed by the hydrogenation of the dinitrotoluene and the phosgenation to TDI. Hydrogen chloride, either as pure or as a concentrated water solution, is recovered from the process, ideally for re-use and/or sale, but this depends on market demand. The hydrogen chloride is used to produce chlorine for the manufacture of phosgene and hydrogen for the manufacture of TDA. Excess phosgene, which is unconverted in the reaction, is recovered for recycling in the process and the residual unrecovered fraction is reacted with NaOH with a removal efficiency of 99.9 %. Any traces of organic solvents may be adsorbed on activated carbon [UBA (Germany), 2000 #143] or incinerated.

13.4.1.2 Storage and loading facilities

Owing to the dangerous properties of TDI and hydrogen chloride, safety considerations are very important in their storage. The boiling point of TDI is approximately 250 °C and it has a correspondingly low vapour pressure at normal storage temperature. The flash point is well over 100 °C so it is not considered flammable. In addition to the generic storage techniques there may be particular TDI storage requirements as follows [HMIP UK, 1993 #100]:

- horizontal or vertical tanks made of an appropriately lined carbon steel or stainless steel
- tanks and associated pipe work are insulated and externally heated (with warm water coils or electric heating) to maintain temperature at 20 - 25 °C (TDI melting point is 13 °C)
- TDI reacts readily with water, acids, bases, alcohols and amines (generally with substantial heat generation and carbon dioxide evolution) and so the air inlet pipe work should have a drying system (e.g. silica gel) or the tank should be padded with dry nitrogen
- stabilising agents may be added to the product both to prevent a loss of quality and to prevent the accidental increase of impurities
- tank breathing losses are often minimised by an internal floating roof structure, or storage under nitrogen at atmospheric pressure
- tank vents are typically routed to scrubbers, or an incinerator. For incinerators, the high destruction temperature of TDI may necessitate a support fuel, especially if the tank is nitrogen blanketed instead of atmospheric.

Systems for loading TDI into trucks or railcars are typically equipped with vapour return systems in order to minimise the releases, or pass to an appropriate treatment technique (e.g. water scrubbing). Emissions of TDI during loading operations are minimised by properly purging relevant piping and coupling connections before decoupling. Purge vents are subsequently sent to vapour return system or treated.

Pure hydrogen chloride is not stored in large volumes, but a small volume buffer tank is typically used to aid its continuous re-use or destruction [UBA (Germany), 2000 #143]. When hydrogen chloride is sold (and especially when present as a concentrated water solution), storage capacity is installed at the minimum level compatible with shipping requirements and buffering needs linked to possible production fluctuations.

13.4.1.3 Raw materials consumption

The selectivity and yield of the reaction of DNT to TDA is 98 - 99 % [Weissermel & Arpe, 1993 #59] {BUA-Stoffbericht 192}. Though literature still mentions among others the reduction by Fe/HCl [Weissermel & Arpe, 1993 #59], the reaction is generally performed by catalytic hydrogenation. Significant progress has been made in reducing raw material losses through catalyst performance and further efforts are continuing, mainly driven by economic factors. The selection of the catalyst is intended to maximise the output of TDA. Once the catalyst is selected, the reaction is monitored carefully to:

- (i) optimise the yields, adjusting the temperature and the proportion of reactants
- (ii) maintain the high yields through frequent (even continuous) analysis of reactants.

Some of the important factors to consider are: the gas distribution; the proper design / maintenance of cyclones and dip legs; the operating instructions; facilities to avoid sparger plugging at shutdown or to blow the dip legs in case of plugging; the catalyst consumption, and the monitoring temperatures and pressures.

Raw materials loss is also reduced by a properly designed TDI recovery system downstream of reaction and the selection of optimum conditions throughout the plant to avoid side reactions or degradation of the desired products [UBA (Germany), 2000 #143].

13.4.1.4 Utilities consumption

The utilities of electricity and steam represent a significant share of the production cost of TDI. Raw water may be a source of significant environmental problems, particularly in hot, dry locations.

The re-use of this energy in the complex is a key issue and a proper energy management system at site level is an essential tool to ensure high performance of a TDI unit. Steam may be generated in the hydrogenation unit and is either sent to a turbine driving air compressors, or used to produce electricity outside of the TDI unit.

The steam consumptions inside the core TDI plant are mainly for distillation of TDA. The steam consumption of new distillation columns can be optimised using standard designs. Existing columns can use re-traying and re-packing techniques, but the reduced steam consumption is often secondary to de-bottlenecking of plant capacity.

The major mechanical energy consumers of a TDI unit are the compressors of the reformation unit for the hydrogen production. The usual ways to reduce the energy consumption of compressors are applicable (i.e. efficient design or reduction of pressure drops) and some minor improvements can also be obtained through the use of gas seals. Especially in hot climates, significant electric power is consumed in refrigeration units necessary to condense phosgene off-gas streams or cool hydrogen chloride to remove impurities [UBA (Germany), 2000 #143].

13.4.2 Air emissions

The hazardous nature of TDI and its ability to sensitise workers necessitate stringent precautions to minimise operational exposure and these have associated environmental benefits.

Generally, the waste gas streams from all processes (manufacture of DNT, TDA and TDI) are treated to remove organic or acidic compounds. Most of the organic load is eliminated by incineration. Scrubbing is used to remove acidic compounds or organic compounds at low concentration. Scrubbing is used as well in combination with incineration.

A range of techniques are used to prevent and control air emissions from TDI production and these include [HMIP UK, 1995 #73] [UBA (Germany), 2000 #143]:

Raw material storage: Nitric acid storage can be vented to wet scrubbers (with re-use of scrubber liquors). Vapour recovery systems or incineration are usually used for vents of organic liquids.

Toluene nitration: Nitration reactor vents are scrubbed (in a weak caustic solution) or, most often, destroyed in a thermal or catalytic incinerator. Selective catalytic reduction may be used to reduce nitrogen oxides and VOC. The nitrogen oxide emissions of a DNT plant (100 tonnes/year) can be reduced by 99.5 % and the VOC emissions (48 tonnes/year) reduced by 99.8 %.

Toluene diamine preparation: Isopropylamine, if isopropanol is used as solvent, and/or other lights are formed by a side reaction and can be destroyed by incineration.

Phosgenation of toluene diamines: Off-gases from phosgenation contain phosgene, hydrogen chloride and, if applicable, o-dichlorobenzene solvent vapours and traces of TDI product. These are recycled to the process where possible. If not, then o-dichlorobenzene and phosgene can be recovered in chilled condensers. Unreacted phosgene is recovered and recycled in the process. Unrecovered residues are destroyed by contacting with caustic soda. Effluent gases are incinerated. The potential for carbon tetrachloride emissions depends on the purity of the carbon monoxide from the phosgene synthesis. Hydrogen chloride that is electrolysed for chlorine and hydrogen generation must be free of o-dichlorobenzene. Hydrogen chloride evolved from the 'hot' phosgenation stage can also be recovered. Scrubbers can remove >99.9 % of the hydrogen chloride from off-gases.

TDI work up and distillation: After o-dichlorobenzene is stripped out and recycled, the off-gases are likely to contain hydrogen chloride (that can be recovered), carbon tetrachloride and phosgene. The hot liquid residues from distillation may be treated for further TDI recovery and are then incinerated.

Phosgene recovery from TDI production: The crude product from 'hot' phosgenation contains about 2 % phosgene that can be recovered by distillation. Alternatively the phosgene can be removed by purging with nitrogen, but this contaminated stream then requires clean-up.

Hydrochloric acid is removed from off-gases by scrubbers (removal > 99.9 %). Waste gas with low concentrations of diisocyanates can be treated by scrubbing with water (achievable concentration <5 mg/m³ diisocyanates).

Phosgene removal from waste gases: Unreacted phosgene is recovered and recycled in the process. The unrecovered phosgene and the off-gases from plants for phosgene processing are destroyed in a decomposition unit. This is achieved by various methods, namely:

- decomposition with alkaline scrubbing agents, mainly sodium hydroxide solution. The residual gas is led through packed towers, at the top of which sodium hydroxide solution is introduced. Make-up sodium hydroxide solution is added under pH control. Venturi scrubbers can also be used
- decomposition in activated carbon towers. The residual gas is passed through towers that are filled with activated carbon and fed with water. Water and residual gas are usually fed concurrently to avoid flooding of the packing. The water is usually recycled. If the concentration of hydrochloric acid that is formed by decomposition of phosgene exceeds 10 %, the decomposition effect is greatly reduced. Therefore a sufficient supply of fresh water must be assured. For safety reasons, two towers in series are frequently used
- combustion. The residual gases are burnt so as to convert phosgene to CO₂ and HCl only. An advantage of this method is that all remaining pollutants in the residual gas, such as solvents and carbon monoxide, are burnt together. Normally, the outlet gas from the phosgene destruction equipment is continuously monitored for residual phosgene content
- primary technical measures. The primary technical measures are aimed at preventing phosgene emission from the closed equipment. This is achieved by, for example, selection of resistant, high-grade materials for equipment and lines; careful testing of this equipment and lines, especially the welds; leak tests before resuming operation of plant units; the use of pumps which are hermetically sealed to the outside (canned motor pumps, magnetic pumps); the use of high-grade materials for flange gaskets; and regular inspections of equipment and lines. In the field of process control engineering, particularly high requirements are set for the quality and design of process control equipment. Plant equipment, which is particularly important for safety, has duplicated process control instrumentation. Automatic systems ensure immediate safe shutdown of the plant when important process parameters move outside a narrow bandwidth. In addition, the probability of phosgene emission and the emission potential are reduced further by continual optimisation of the process system. In this way the number of vessels containing phosgene, and their phosgene content, are reduced
- secondary technical measures. Secondary technical measures are used to detect leaks as soon as possible and to combat escaped phosgene. These measures include, for example, continuously operating alarm systems for monitoring room air and ambient air, systems for combating escaped phosgene by chemical reaction (e.g. steam ammonia curtains in the case of gaseous emissions), jacketed pipes, and complete containment for phosgene processing plants or plant units
- organisational measures. The organisational measures ensure that the staff operate the plants safely and initiate rapid countermeasures following malfunctions or the detection of leaks. These measures include special training, routine plant inspection, training for exceptional situations, clear operating instructions, and regular safety discussions
- personal safety precautions. The personal safety precautions ensure that staff are protected from exposure during a possible release of phosgene into the atmosphere and that a possible exposure is detected early enough to prevent inhalation of a dose which would be dangerous to health. Staff are therefore equipped with escape masks or respirators.

New processes that use the best combination of techniques are able to achieve the limits in Table 13.3.

Parameter	mg/m ³
Phosgene	1
Hydrogen chloride	10
Diisocyanates (as total NCO Group)	0.1
Oxides of sulphur (expressed as SO ₂)	300
Oxides of nitrogen (from nitration process) expressed as NO ₂	100
Oxides of nitrogen (from combustion) expressed as NO ₂	300
Total particulate matter	20
Volatile Organic Compounds (excluding particulate matter)	
Total Class A compounds (as the compound)	20
Total Class B compounds (as toluene)	80
Note: Reference conditions for achievable levels are 273K, 101.3 kPa	

Table 13.3: Achievable releases from new TDI processes
[HMIP UK, 1995 #73]

13.4.2.1 Absorber vent off-gas

The reaction off-gases in the stream leaving the process absorber contain non-condensable components (nitrogen, oxygen, carbon monoxide, carbon dioxide and argon) as well as vaporised water and traces of organic contaminants.

13.4.2.2 Residues incineration

Any TDI plant may have facilities to incinerate process residues and facilities for re-use of hydrogen chloride. The incineration facilities will generate combustion flue gases. Techniques to minimise this stream include reducing the formation of residues at the reaction step (through reaction monitoring) and ensuring proper operating conditions (to reduce the loss of valuable products in the residue streams and to avoid degradation of valuable products throughout the unit). Flue gases, after heat recovery, are usually treated in caustic water scrubbing facilities. Catalyst fines, when present in the flue gas, may be collected by an electrostatic precipitator.

13.4.2.3 Miscellaneous vent streams

There are a number of other diverse origins for vents, including: process vessels, loading facilities, process analysers, sampling connections, safety valves and maintenance vents. The vents usually contain valuable products (TDI, hydrogen chloride) diluted by non-condensable gases (carbon dioxide, nitrogen, oxygen). Some of the techniques to minimise these streams include:

- vapour phase equilibrium during transfer and loading operations
- closed sampling systems
- proper operating procedures to clean the unit prior to maintenance.

The vents are usually treated in water or caustic scrubbers. When large quantities of volatile organic compounds are likely to be present, the stream may be flared or sent to incineration.

13.4.2.4 Fugitive emissions

Fugitive emissions are generally low because the process pressure is moderate. Fugitives will mainly consist of TDI, hydrogen chloride and volatile organic compounds. Due to their toxic nature, the permitted levels for TDI and hydrogen chloride in ambient air are very low and sensitive detection systems are installed for continuous monitoring of ambient air quality. For occupational health reasons, and with consequential environmental benefit, extensive measures have been taken to prevent releases. Preventative techniques are described in Sections 13.4.2 and 5.3.1.3.

13.4.3 Water emissions

Toluene nitration: Inorganic components of the waste water are sulphate and nitrite / nitrate. Optimisation of the process can give emissions of <10 kg nitrate/ t DNT and much lower content of nitrite (before further removal by the biological treatment). Effluent contains organic products and by-products, namely di- and trinitrocresols. Many of the nitro-organic components are toxic and poorly biodegradable. Figures for biodegradation of the whole effluent depend on the ratio of poorly biodegradable compounds and biodegradable compounds such as unreacted toluene. Alternative techniques to reduce the organic load of the effluents from the nitration process are adsorption, extraction or stripping, thermolysis/hydrolysis or oxidation. Extraction (e.g. with toluene), which is used mostly, gives an almost complete removal of DNT and a reduction of nitrocresols to <0.5 kg/t.

Under certain site conditions the waste water may be treated by ozonisation, or recovery of the nitro-compounds followed by incineration.

In a German plant, waste water from the nitration unit is pre-treated together with a stream from the polyol plant (2.5 m³/h) in a three-stage plant (see below) mainly to eliminate the highly persistent and toxic part of the COD. The overall COD elimination is 98 % and the elimination of the nitro aromatic compounds is >99 % [UBA (Germany), 2000 #92].

- stage 1: In the adsorption/sedimentation unit, organic substances are adsorbed by sludge from a biological treatment plant, and the sludge is separated by sedimentation and incinerated. The COD elimination is 22 %
- stage 2: Biological pre-treatment includes denitrification of nitrite/nitrate and adsorption of nitro-aromatic compounds, and further reduces COD by 59 % (COD elimination 80 %). The sludge is incinerated
- stage 3: In the ozonation step, the non-degradable COD (i.e. nitro-aromatic substances) is converted to degradable COD to make it amenable to further treatment in the central biological plant. This further reduces COD by only 4 % (COD elimination 21 % in the ozonation step with only 1.5 kg ozone / kg reduction of COD) but biodegradability of the remaining organic load improved and was measured to be 88 % (Zahn-Wellens test).

Toluene diamine preparation: Ammonia can be separated by stripping. Low-boiling components can be separated by distillation / stripping with steam and destroyed by incineration. Achievable elimination rates are: amino toluene >99 %, TDA>90 % and COD>70 %. Pre-treated process water can be re-used in the production process. Isopropanol, when used, can be recovered for re-use. Any isopropanol that is lost in water from the scrubbers can be biologically treated.

Phosgenation of toluene diamines: Effluents from off-gas decomposition towers are slightly acidic and contain traces of o-dichlorobenzene solvent. Traces of o-dichlorobenzene solvent in the waste water can be biologically treated or delivered to a combustor with heat recovery and neutralisation of halogenated effluents.

New TDI processes are able to achieve release limits of 10 mg/l chlorobenzene and 10 mg/l o-dichlorobenzene [HMIP UK, 1995 #73]. Referring to measurements at a German site the emission of o-dichlorobenzene after biological treatment is <1g/tonne TDI. When using dichlorobenzene as a solvent, process-integrated measures have to be taken to minimise/prevent the formation of traces of hexachlorobenzene in the electrolysis of hydrochloric acid.

The TDI process produces water in the nitration and hydrogenation steps and the rejection of water from the process is a critical part in the design of all TDI plants. Many differing techniques are used depending upon the individual circumstances and location of the production unit. Key steps normally involve concentrating the contaminant in the water stream using evaporation (either single or multiple effect).

The concentrated contaminated stream is handled in a number of different ways depending on the design of the plant. These include burning the stream or recycling to other parts of the process to maximise recovery of saleable products before burning the contaminated stream. The 'clean' water stream recovered from these concentration processes is further treated, normally, in biological waste water treatment plants prior to discharge. The biological treatment units can either be a central site facility or specific to the TDI plant. Adaptation of the plant biology to the nitro-aromatic compounds is crucial part to ensure biodegradation.

13.4.4 Wastes

Recovered hydrogenation catalyst is recycled after centrifugation. A fraction is purged from the process and may be regenerated by specialised companies, or incinerated or pre-treated prior to final disposal.

Organic wastes from the manufacture of DNT, TDA and TDI are incinerated.

13.4.5 Plant safety

A lot of hazardous substances are used partially in large quantities: chlorine, TDI, TDA, carbon monoxide, phosgene, hydrogen, nitric acid, nitrogen oxides, DNT, toluene etc. A safety report under the Seveso II Directive (Council Directive 96/82/EEC of 9 December 1996 on the control of major-accident hazards involving dangerous substances) is needed. Plant safety is highly important in air pollution prevention and waste water minimisation.

13.4.5.1 Dinitrotoluene (DNT)

Dinitrotoluene melts at 55 – 60 °C and is usually stored and transported in molten form within installations. Decomposition begins at 260 °C and precautions must be taken to ensure that pure, washed DNT is not heated above 200 °C. For acid DNT the limit is much lower and depends on the composition.

13.4.5.2 Toluene diisocyanate (TDI)

TDI and products containing TDI are reactive and hazardous chemicals. TDI should only be handled by knowledgeable well-trained personnel who thoroughly understand the hazards associated with the transportation, storage, and the use of the chemical (from Polyurethane TDI Handbook, BASF Corporation).

Care should be taken to prevent contact of water with TDI as water reacts readily with TDI and is the common contaminant of diisocyanates. The hazard of this reaction is the formation of CO₂ and the resultant increase of pressure in closed containers. Even small amount of water can cause significant problems and the following safety recommendations must be observed:

- Store TDI in a dry environment using dry nitrogen or a dry air pad.
- Plug and cap all lines leading to and from storage tanks.
- Fittings and line connections should be maintained and stored in a dry environment.
- Do not tightly close any container of TDI that has been, or is suspected of having been, contaminated with water.

Contamination by basic compounds such as caustic soda, amines, or other similar materials must be avoided. The reaction of TDI with these materials may cause the generation of heat and CO₂. The liberation of CO₂ in tightly closed or restricted vessels or transfer lines may result in a violent rupture (from Polyurethane TDI Handbook, BASF Corporation).

13.4.5.3 Phosgene

Phosgene, as it is produced in integrated installations for TDI, has to be handled very carefully because of its gaseous and very toxic character. Two of the common methods to prevent plant safety are:

- Containment - In this case all phosgene operations are carried out in closed buildings. The waste gases of the rooms can be emitted untreated. Phosgene sensors supervise the concentration in the building. If phosgene is measured all phosgene contaminated (room) gases have to be collected and destroyed (for example by alkaline scrubbing).
- Ammonia steam curtain - No containment is needed. The surrounding area is monitored. By release of phosgene the whole phosgene unit is set under a steam curtain. Ammonia is added to the steam to react with the phosgene.

13.5 Best Available Techniques

As explained in Chapter 6, BAT for a particular LVOC process is determined by considering the three levels of BAT in the following order of precedence: illustrative process BAT (where it exists); LVOC Generic BAT; and finally any relevant Horizontal BAT. The following techniques are BAT for the illustrative process of TDI production.

BAT for the process design:

- All TDI plants in the world now use the process basing on toluene by the phosgene process route and this is BAT.

BAT for consumption and re-use:

- BAT involves optimising the re-use of hydrogen chloride
- BAT involves optimising the re-use of sulphuric acid (manufacture of DNT)
- BAT is to reutilise the energy re-use potential of the exothermic reaction (without compromising yield optimisation) and of the waste gas incineration (e.g. recuperative incinerator).

BAT for air emissions:

- BAT for waste gases is the treatment with scrubbers (in particular for phosgene, hydrogen chloride and VOC removal) or thermal incineration for the destruction of organic compounds and nitrogen oxides. Low concentrations of organics can be treated by other techniques such as activated carbon. Nitrogen oxides also can be minimised by partial oxidation. BAT is also every equivalent combination of treatment methods.
- Emission concentrations (as hourly averages) associated with these techniques are $< 0.5 \text{ mg/m}^3$ phosgene, $< 10 \text{ mg/m}^3$ hydrogen chloride. Organic compounds measured as Total Carbon $< 20 \text{ mg/m}^3$ (hourly average) are associated with incineration techniques.

BAT for the waste water from nitration is:

- reduction of waste water and nitrate/nitrite emission by optimising the DNT process (waste water volume (process water) $< 1 \text{ m}^3/\text{t}$)
- maximise the re-use of process water

- removal of nitroaromatic compounds (DNT, Di/Tri-Nitroresols) to reduce organic load (< 1 kg TOC /t DNT) and to ensure biodegradability (>80 % elimination by Zahn-Wellens test). Final biological treatment to remove COD/TOC and nitrate
- incineration (*in lieu* of waste water pre-treatment and biological treatment).

BAT for the waste water from hydrogenation is:

- removal of nitroaromatic compounds by stripping, distillation and/or extraction of aqueous effluents
- re-use of pre-treated process water. Waste water volume (process water) < 1 m³/t TDA
- incineration (*in lieu* of waste water pre-treatment and biological treatment).

BAT for the waste water from phosgenation is:

- optimisation of processes to ensure an organic load of TOC<0.5 kg/t TDI prior to biological treatment.

BAT for plant safety is:

- partial containment of the most hazardous elements of the phosgenation process or mitigation measures (e.g. steam/ammonia curtain) is BAT as safety method in the case of accidental phosgene releases.

13.6 Emerging techniques

Phosgene use can also be avoided by using dimethyl carbonate for TDI production. In Japan, Ube have a pilot plant for the selective gas-phase carbonylation of methanol [Weissermel & Arpe, 1993 #59], but these techniques were never used at an industrial scale.

14 CONCLUDING REMARKS

This chapter concludes on the information exchange exercise for the LVOC sector and takes a forward look at issues that should be considered in any future update of the BREF.

14.1 Review of the information exchange

The information exchange for LVOC was generally very successful. A high degree of consensus was reached following the second Technical Working Group (TWG) meeting and there are no split views in this document. Much information was made available and there was a high degree of participation by industry and Member States.

Due to the diversity of LVOC processes, the BREF does not give a very detailed examination of the whole LVOC sector. It does, however, make a good first attempt at defining BAT for the sector as a whole and for the chosen illustrative processes.

14.1.1 Programme of work

Figure 14.1 shows the timing of key phases in the information exchange for LVOC. Further explanation of some of the phases is given below.

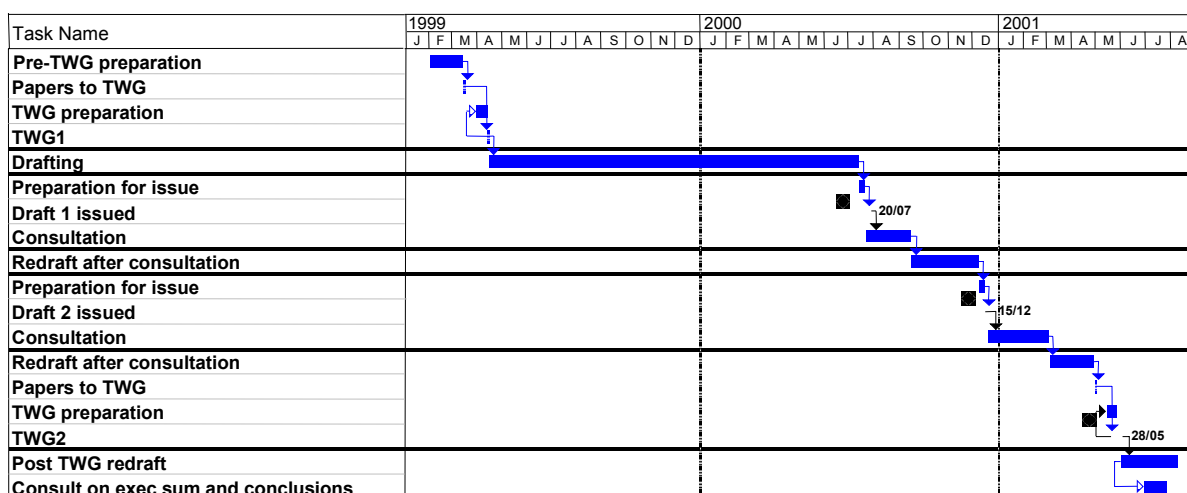

Figure 14.1: Gantt chart for the LVOC BREF work programme

Although substantive work for the EIPPCB began in February 1999 with the preparation of background papers for the TWG kick-off meeting, significant work had already been undertaken at the 1997 'Paris Workshop'. This workshop was organised by CITEPA on behalf of the European Commission and aimed to identify how an information exchange could be organised for the chemical industry as a whole. The workshop gave rise to the term LVOC and established an initial BREF structure using the concept of 'Family' and 'Process' BREFs to deal with the large number and diversity of LVOC processes.

The kick-off meeting of the LVOC TWG was held in Seville on 13 - 14 April 1999. Building upon the foundations laid by the Paris Workshop, the BREF scope and structure were agreed. The main change from the Paris Workshop decisions was the addition of a middle tier to the BREF to bridge the gap between high-level generic information (the "Family" BREF) and highly specific information for the illustrative processes (the "Process" BREF). After the meeting, TWG members were asked to complete a questionnaire indicating for which parts of the BREF, and when, they were able to contribute information. This proved useful in cementing promises of information and in identifying any information shortfalls.

A 340-page first draft was issued in July 2000. Drafting of the text took some 15 months (6 months longer than originally envisaged) mainly because of delays experienced by TWG members in compiling data and writing contributory reports. The first draft was deliberately delayed to allow incorporation of CEFIC contributions as these were seen as particularly important to the document's integrity.

Almost 800 comments were made by the TWG on the first draft - all of them electronically. This enabled much easier handling of the comments and, when subsequently annotated with EIPPCB decisions, it also provided a transparent record of how and why comments had been implemented.

Consideration of the comments and of additional technical material resulted in the issue of a 390-page second draft in December 2000. The second draft included BAT conclusions for all the illustrative processes as well as a Generic LVOC BAT. Some 700 comments were made on the second draft.

The second meeting of the TWG was held in Seville from 28 – 30 May 2001. After an introductory review of the information exchange, most of the discussions were about the BAT components of the BREF. Whilst BAT for individual illustrative processes was agreed fairly readily, there was much longer discussion on the Generic LVOC BAT (Chapter 6). A good level of consensus was finally reached but it was difficult to agree Generic BAT that was flexible enough to cover all LVOC processes and yet specific enough for permit writing purposes. This has led to Generic LVOC BAT becoming quasi-horizontal.

Most discussion at the second TWG meeting surrounded the definition of Generic BAT for air and water pollutants. The main reasons for this were the lack of emission data and the absence of a pan-European, air pollutant classification system.

14.1.2 Information sources

Over 150 items of technical material were submitted to the information exchange. There was a generally good spread of information over the LVOC industrial sector although there was often a frustrating lack of quantitative data on emissions and costs. The illustrative process chapters of the BREF owe much to the reports submitted by CEFIC and their considerable efforts in co-ordinating European process reviews (often for the very first time). Other significant contributions were received from, in no order of importance, Austria, Finland, Germany, Italy, the Netherlands, Sweden and the UK.

Over 140 items (technical material, draft BREFs, completed TWG spreadsheets etc.) were placed on the Members' Workspace of the EIPPCB web-site. At the time of the second TWG meeting (May 2001) these documents had, in total, been accessed on over 1000 occasions. This demonstrates a highly active TWG that made good use of the electronic exchange forum provided by the Members' Workspace.

One particular complication with the LVOC BREF was the lack of foundations upon which BAT conclusions could be based. BREFs usually review the whole range of techniques that are used in an industrial sector and then distil out those that provide the best environmental performance in order to reach BAT conclusions. In the case of LVOC much of the reviewing of techniques was (or is being) carried out in horizontal BREFs (most notably the BREF on 'Waste water / waste gas management / treatment in the chemical industry'). Whilst there was frequent co-ordination in the drafting of the LVOC and horizontal BREFs, the interface was problematic because the foundations for BAT conclusions are not always in the LVOC BREF and those foundations were often not fixed (due to simultaneous drafting of BREFs).

Although data have been validated by TWG members, very few site visits were undertaken by EIPPCB due to a lack of time and the large number of industrial processes under consideration.

14.2 Recommendations for future work

The IPPC BREF Outline and Guide (IEF November 2000) states that this section will identify “any gap or weakness in knowledge” and give recommendations “for further research or information gathering and for the time-scale for updating the reference document, in the light of ongoing technical and/or economic developments”.

The EC is launching and supporting, through its RTD programmes, a series of projects dealing with clean technologies, emerging effluent treatment and recycling technologies and management strategies. Potentially these projects could provide a useful contribution to future BREF reviews. Readers are therefore invited to inform the EIPPCB of any research results which are relevant to the scope of this document (see also the preface of this document).

The following recommendations are made as a result of the information exchange on LVOC.

14.2.1 Future illustrative processes

Illustrative processes were chosen using the following criteria:

- the process has significant economic importance
- the process has environmental emissions or issues that warrant an exchange of information
- the process is operated at a number of sites across Europe so that a meaningful range of data is obtained
- the process is illustrative of other processes in its LVOC sub-sector (e.g. because of the unit processes or unit operations that are used).

Whilst the TWG accepted these as sound selection criteria, it was suggested by the Netherlands that the criteria could be developed into a methodology that would provide for more logical and accountable selection of illustrative processes. This should be given further consideration in advance of any future information exchange. Several members also wanted more emphasis to be put on the significance of environmental impacts.

Notwithstanding any selection procedure for future illustrative processes, the information exchange has already identified a number of candidate processes.

2-ethyl hexanol. There was a concern [UBA (Germany), 2000 #92] at the kick-off meeting that the choice of illustrative processes focused excessively on continuous gas-phase reactions. The only aqueous-phase reaction that had been selected (the manufacture of ethylene glycol) uses hydrolysis and raises minor water pollution issues. To better address water pollution issues, the production of ethyl alcohol was suggested as an additional illustrative process in the ‘Oxygenated’ sub-sector. A chapter on this process appeared in the first draft of the BREF but there was insufficient information for it to warrant continued inclusion. Coverage of the process is now restricted to a short description in Chapter 3. It is therefore recommended that the process for the production of 2-ethylhexanol be given priority consideration for inclusion as an illustrative process when the BREF is next revised.

Phenol. In a similar manner the kick-off meeting also received a proposal from Finland to include phenol production as an illustrative process. Again there was insufficient information to prepare a full chapter and coverage is restricted to a short description in Chapter 3. It is therefore recommended that the process for phenol production be given priority consideration for inclusion as an illustrative process when the BREF is next revised.

Adipic acid. Following on from the Kyoto Protocol, the EC commissioned a report [Ecofys / AEA Technology, 2001 #150] that highlighted the impact of unabated emissions of nitrous oxide from a European adipic acid producer. There was insufficient information to prepare a full chapter on the process and coverage is restricted to a short description in Chapter 3. The

Environment DG proposes the inclusion of adipic acid production as a future illustrative process. CEFIC questions whether adipic acid production meets the selection criteria for illustrative processes as there are few EU installations and almost all units have solved the critical environmental issue of nitrous oxide emissions. It is recommended that the process for adipic acid production be considered for inclusion as an illustrative process when the BREF is next revised.

TDI. Although Chapter 14 covers the process for the production of TDI, it has not benefited from the pan-European overview that CEFIC have been able to contribute to the other illustrative processes. The chapter relies heavily on the information submitted by Germany, but is lacking in some detail. It is therefore recommended that the process for TDI production be given priority consideration for review as an illustrative process in the next BREF.

Other processes. In comments on the second draft of the BREF, CEFIC indicated that important LVOC products, such as ethylbenzene, styrene and propylene oxide, should be considered for future inclusion as illustrative processes.

14.2.2 Interface with other BREFs

Horizontal BREFs. The aim is that vertical and horizontal BREFs provide a matrix of BAT information. The BREF work programme meant that the LVOC BREF was being written at the same time as horizontal BREFs. This created a series of moving targets for LVOC and it will be difficult to know if there are any significant gaps or overlaps until all horizontal BREFs have been completed. Future revisions of the LVOC BREF should therefore be made in conjunction with an assessment of the information in horizontal BREFs, but especially those for WWWG and Storage.

Vertical BREFs. In a similar way, the scope of LVOC was set without knowing the exact scope of the other organic chemical BREFs (for Fine Organics and Polymers) and inorganic chemical BREFs. Future revisions of the LVOC BREF should therefore be made in conjunction with an assessment of the information in vertical BREFs on the chemical industry. Several LVOC topics deserve particular attention.

- very little information has been submitted on LVOC processes for the production of sulphur compounds, phosphorus compounds and organo-metal compounds. It is possible that these processes may be better covered in the Fine Organics BREF
- the production of urea is described briefly in Section 3.5.2 but may be better covered by a BREF on inorganic chemicals.

14.2.3 Whole effluent assessment

Whole Effluent Assessment is potentially a very useful and powerful parameter for evaluating the complex waste waters discharged by the LVOC industry. This topic is covered in more detail in the WWWG BREF [EIPPCB, Draft #48]. Developments in testing, with respect to monitoring data and statistics, methods and international standards and national classification systems, should be reconsidered in future revisions of this BREF to see if toxicity assessment has a wider role to play in the LVOC industry.

14.2.4 Emission and consumption data

Although the illustrative process chapters of this BREF contain good summaries of emission / consumption data for the European LVOC industry, there is often an absence of detailed data for specific installations. The BREF rightly makes great use of the emission / consumption data submitted by CEFIC. This brings to the document a high level of credibility and authority as well as a consistent structure and degree of detail. The CEFIC submissions involved a considerable amount of work and are acknowledged as key components of the information

exchange. The surveys of the environmental performance were particularly valuable as they established benchmarks against which European installations could be compared – in many cases probably for the first time.

For some of the illustrative processes, however, there is a frustrating lack of numerical emission / consumption data, which makes it difficult to determine BAT-associated levels. Where emission data do exist they are undermined by industry's decision to aggregate into ranges in order to provide contributor anonymity. Only in the case of lower olefins, where emission ranges were sub-divided into tertiles (thirds), was it possible to undertake a more detailed assessment of BAT-associated levels.

Even where emission / consumption data were available for LVOC processes, it was often difficult to make meaningful comparisons of performance. This was because of the complications introduced by such factors as the degree of integration with other processes and the reliance on central treatment facilities. The development of environmental benchmark methodologies is needed prior to any future LVOC information exchange to provide more consistent emission data that will, in turn, allow a more logical and detailed assessment of BAT. Any such benchmarking methodologies should give consideration, *inter alia*, to the definition of installation boundaries and emission reference conditions (sampling / averaging time, measuring methods, etc.). It should also be noted that any such benchmarking exercise will be complex and time-consuming and may encounter issues of confidentiality.

14.2.5 Cost data

There has been very limited submission of cost data for the techniques discussed in the BREF. Since cost information is fundamental in the decision making process to determine BAT, it has sometimes been difficult to reach an objective BAT conclusion. In any future information exchange there should be particular emphasis on the collection of cost data for all techniques.

Where cost data have been provided, TWG members have commented that the decision to leave cost data in the original units (i.e. without standardisation of currency or date) makes it difficult to compare the relative prices of techniques. However, cost standardisation is dependent on an agreed standard method that considers not only exchange rates but also discounting. No such method was identified by the TWG and therefore, rather than using an economically unsound conversion method, data have been left in their original units. The absence of a standard conversion method is an issue for all BREFs and so the preparation of a solution is outside the scope of the LVOC BREF.

14.2.6 Other pollutants / issues

Article 2(2) of the IPPC directive (96/61/EC) states that 'pollution' is the introduction into the air, water and land environments of 'substances, vibrations, heat or noise'. This BREF provides detailed information on the substances that may be released from LVOC processes and, in combination with the horizontal BREF on Cooling Systems, information on heat releases. There is, however, comparatively little information on the topics of **vibration and noise**. This information shortfall should be addressed in any future information exchange / BREF review.

The **decommissioning of plants** is also specifically mentioned in the Directive (at Article 2.11 and Annex IV) but, other than brief consideration in Section 5.1.4, the issue is barely addressed in the BREF. Future revisions of the LVOC BREF should consider whether additional information is required, or whether this topic would be better considered by a dedicated horizontal BREF.

The Directive similarly states that the determination of BAT should give special consideration to the need to **prevent accidents** (Annex IV). Very little information was submitted on this

issue, possibly because of potential overlap with the Seveso II Directive. Any future revision of the LVOC BREF should give more consideration to this topic.

14.2.7 Interface with chemical risk reduction strategy

A question was raised at the second meeting of the TWG about how the BREF interfaces and co-ordinates with the EU's development of risk reduction strategies for chemicals under Council Regulation (EEC) 793/93 on the evaluation and control of the risks of existing substances. The issue has not been addressed in this document and should receive consideration in any future BREF revision.

14.2.8 Separate illustrative process documents?

Draft 1 of the LVOC BREF led the Netherlands to suggest publishing separate documents for the illustrative processes since regulators don't necessarily need the sections on, for example, aromatics when they license a steam cracker. The main disadvantage of such a proposal would be the larger overall publication resulting from creating stand-alone illustrative process documents (i.e. with an Executive summary, preface, scope, etc.). The advantages would be smaller and better targeted documents that are easier to update. It also might fit with the idea of covering a different selection of illustrative processes each time the BREF is revised (i.e. creating a core 'generic' document and a growing number of detailed 'illustrative process' documents). In addition, the concept will be facilitated by the ability to carry out electronic searches for information (e.g. on a CD of the BREF series). The idea of separate documents should be considered in any future BREF revision.

14.2.9 Classification system for air pollutants

The Generic BAT for air pollutants (as reported in Chapter 6) relies heavily on the classification system that is used in one Member State (the Netherlands). This classification system was adopted by the TWG as an example of good practice and does not preclude the use of other classification systems. This approach was adopted because Europe has no standard classification system for air pollutants. Whilst it would be beyond the scope of a BREF review to establish an agreed European air pollutant classification system, such a system would have considerable value in the future development of LVOC BAT. Although it is recognised that such an exercise would be complex and time-consuming, a recommendation is made to the Environment DG to consider such an initiative.

14.2.10 The 'wider value' of illustrative processes?

One of the quoted advantages of illustrative processes was that they would 'illuminate' the concept of LVOC BAT beyond the illustrative process itself. Although the chosen illustrative processes do give practical examples of BAT for LVOC processes, the details are necessarily very specific to the process in question and it is doubtful that they have value to other LVOC processes. Because the BREF is so long, it is also doubtful whether a regulator writing a permit would have the time or inclination to search for such, less-obvious, sources of information. If this assessment is true, then future BREF revisions may need to expand Chapter 3 beyond the current, very brief 'thumbnail' process descriptions. This issue should be considered in any future BREF revision.

14.2.11 Biotechnology

Chapter 15 on emerging techniques identifies the growing importance of biotechnology in the production of fine organic chemicals. There are currently few applications of biotechnology in the production of LVOC and it is recommended as a field that warrants further research and development.

14.2.12 Thresholds for the repair of fugitive losses

Section 5.3.1.3.3 considered the threshold leak rates which trigger the repair of fugitive losses. It also outlined the different approaches suggested by CEFIC and the Netherlands but there has been little discussion on the relative merit of the two proposals. It is recommended that any future BREF revision gives this topic further consideration with a possible view to establishing a common approach.

14.2.13 Timing of BREF revision

It is difficult to give a definitive time-scale for updating this document but the following factors are considered pertinent in the decision:

- processes in the LVOC sector are generally well-established and major technological changes do not occur very frequently. If this continues to hold true, then there would be little incentive for early revision of the BREF
- the above recommendations should be compared with the recommendations made in other BREFs so that the highest priority issues (and any common themes) are identified for the whole BREF series
- the above list of recommendations is lengthy and will need to be prioritised. It is suggested by CEFIC that Environmental Benchmarking (14.2.4) warrants particular attention
- use of the LVOC BREF should be monitored to see if the Generic BAT chapter provides adequate information to set BAT-based permit conditions for non-illustrative processes. If the information proves inadequate to this task then there will be a more immediate need for BREF revision.

15 EMERGING TECHNIQUES

The emerging techniques described in this chapter have not yet been applied on a commercial basis or outside of pilot plant operation but in the future can be expected to be applicable to LVOC processes. These techniques are in addition to those emerging techniques that have been identified for particular illustrative processes.

15.1 Unit processes

Some possible approaches for cleaner unit processes are as follows:

Nitration [Sikdar & Howell, 1998 #101]

- devise better methods of cleaning the waste acid, for example by combining separation with a concentration step. This might be achieved by membrane separations if suitable acid-resistant membranes are developed
- the environmental impact of nitration can be reduced by replacing the mixed acid with a less strong acid. There has been some success in the manufacture of explosives with the use of nitrogen pentoxide as a nitrating agent in an inert organic solvent. In the nitration of strained-ring heterocyclic compounds, the nitrogen pentoxide is completely incorporated and so no by-products are formed. Nitrogen pentoxide has also been used in nitro-desilylation reactions where the by-products were recycled and re-used
- development trend for solid-state nitration systems as this simplifies the separation and purification issues
- Ytterbium (III) trifluoromethanesulphonate catalysts have been used in aromatic nitrations and produce good yields with water as the only by-product. The nitrating medium was 69 % nitric acid in dichloromethane.

Halogenation [Sikdar & Howell, 1998 #101]

Halogenation reactions can create considerable environmental burdens. The development of cleaner processes has four main objectives:

- avoiding the use of extremely dangerous reactants (e.g. phosgene in the manufacture of bisphenol A)
- improving reaction specificity for a target isomer
- avoiding waste product formation, such as sodium chloride and
- designing entirely novel pathways.

Aromatic chlorination can be improved by developing or improving the following:

- (a) convert by-product HCl back to molecular chlorine to improve chlorine efficiency. On small volume processes the Kel-Chlor (modified Deacon) process uses Mn or Cu salts in a fluidised bed reactor to catalyse the oxidation of HCl back to chlorine. The cost of recycled chlorine was estimated to be \$80 per tonne, in contrast to \$200 per tonne for virgin chlorine. DuPont has also developed a dry electrolytic membrane process to recover chlorine from HCl. The capital and operating costs are expected to be 30 - 40 % of commercial wet electrochemical and catalytic processes
- (b) continue the development of catalysts to improve yields of selected isomers, for instance, paradichlorobenzene. Zinc bromide supported on mesoporous silica or activated montmorillonite clay allowed a fast and selective bromination of aromatic compounds.

Alkylation [Sikdar & Howell, 1998 #101]

There are several approaches to reducing the environmental impact of acid catalysed alkylation. Current attempts toward cleaner alkylation are centred on avoiding the use of corrosive acids; improving product specificity and finding novel reaction pathways. There is development of

supported strong acids (to replace liquid acid catalysts) such as antimony pentafluoride (SbF_5) supported on silica, trifluoromethanesulphonic acid on a silica support, and an organometallic 'salt' of SbF_5 .

Oxidation [Sikdar & Howell, 1998 #101]

Several areas of pollution minimisation in oxidation operations are as follows:

- a) emphasise engineering design of reactors. Oxidation is almost invariably exothermic, and heat removal is of prime importance. Wall effects are another factor affecting product purity. Operating at high Reynolds numbers or with fluidised beds can improve product specificity. More rugged catalysts are required for these conditions
- b) improve quality control of existing catalysts. Heterogeneity in catalyst beds can produce 'hot' or 'cold' spots, resulting in production of either over, or under, oxidised species, and fragile catalyst surfaces can abrade. The fines can contaminate products, but more importantly, the worn catalyst surfaces are not as effective
- c) continue the development of 'environmentally friendly' catalysts. While some of these may not seem as efficient or as economical at first, the overall environmental cost may be lowered. Researchers at Nagoya University in Japan have developed a halide-free oxidation catalyst system that can oxidise primary and secondary alcohols to acids and ketones with turnover numbers higher than conventional systems by two orders of magnitude. This clean catalyst system consists of aqueous hydrogen peroxide, a phase transfer catalyst of a lipophilic quaternary ammonium hydrogen sulphate, and a tungsten catalyst. Monsanto reportedly will build a commercial plant for phenol manufacture by the one-step catalytic oxidation of benzene by nitrous oxide using a zeolite-based catalyst. The product yield in this new process is 99 %, compared to 93 % via a familiar cumene-based process. A group led by Marko at the Catholic University of Louvain in Belgium has succeeded in conducting an oxidation reaction with air with very high product selectivity. Using a catalyst system, copper (I) chloride complexed to phenanthroline and azo compound supported on potassium carbonate, the group was able to convert primary alcohols to aldehydes with 97 % yield at 70 - 90 °C in less than 2 h
- d) continue to develop innovative oxidation unit processes, such as photo-catalytic oxidation. Develop new or improved semiconductors for this process. Develop more efficient and versatile photon sources; mercury vapour lamps have poor quantum efficiencies in the desired wavelength. Some newer sources such as xenon lamps might be more efficient.

Sulphonation [Sikdar & Howell, 1998 #101]

Organic sulphonation/sulphation can be made less polluting by following techniques:

- a) sulphuric acid aerosols are thought to contribute to global warming. Greater care in the design and operation of sulphonators and their exhaust systems could ameliorate emission of aerosol
- b) the reaction water is removed to keep the acid strength high. This could be done by azeotroping the water off, or installing a membrane separator in a 'pump around' configuration to continuously remove water either by reverse osmosis or pervaporation. Such a membrane separator awaits the development of cost-effective acid-resistant membranes
- c) develop better control systems to minimise oxidation and charring during sulphonation
- d) conduct research on cleaner sulphonation/sulphation mechanisms aimed at maximising yield without over-sulphonation and/or over-oxidation.

15.2 Biotechnology

Biotechnology has already become a key technology in the production of pharmaceuticals and, according to many sources, is considered a key future technology for the wider production of organic chemicals. Some key issues regarding the use of biotechnology are [Wolf & Sorup, 2000 #156] [UBA (Germany), 2001 #157]:

- a literature review identified 54 chemicals that have been produced using biotechnological processes, although many of these only at a laboratory scale
- the chemicals produced by biotechnological processes are mainly alcohols, organic acids, amino acids and vitamins
- biotechnology has greatest applicability in the synthesis of high value fine organic chemicals (because the higher costs of biotechnical processes can be supported by higher product prices)
- there appear to be very few firm plans for the future production of bulk chemicals using biotechnology
- a comparison of the production of 23 bulk and fine chemicals by conventional chemical routes and biotechnology routes, identified that biotechnology generally has environmental benefits. The main benefits of biotechnology were:
 - renewable biological sources often provide the process feedstock
 - the processes usually employ mild reaction conditions
 - less harmful substances are involved
 - the products and by-products are biodegradable.
- an analysis of the requirements and hindrances for the wider use of biotechnology showed that the advanced state of current chemical processes is the most important hindrance. Existing chemical processes have the advantage of proven reliability and product quality. Furthermore, the development costs of chemical process and the investment in plant are, in many cases, already depreciated
- the current legal framework in Germany does not pose any obvious hindrances to the development of biotechnological processes
- production costs of bulk chemicals are determined by feedstock costs but, despite rises in crude oil prices, biotechnological routes for bulk chemicals are still generally too expensive
- the potential of biotechnological processes in the field of bulk chemicals in Europe arises mainly from the use of organic residues from other industrial processes for feedstock, e.g. raw glycerol from the processing of vegetable or animal oils and fats
- there is a demand for research and development with respect to basic research, optimisation of processes and scale up of biotechnological processes for the production of chemicals
- biotechnological processes for the production of acetone/butanol and 1,3-propanediol were identified as having the potential for commercial breakthrough if provided with start-up support
- it has been reported that a biotechnological process can produce 20000 tonnes per year of acrylamide through the action of resting cells of *Rhodococcus rhodochrous* on an acrylonitrile substrate. This is done in a batch process with a high substrate concentration and conversion rate (Dr Oliver Wolf, IPTS, Sevilla – Personal Communication).

15.3 Catalyst development

At the second meeting of the TWG, CEFIC expressed a view that developments in reaction catalysts would bring future environmental benefits. These developments are typically part of ongoing process optimisation and it is difficult to make generic statements on emerging catalysts for all LVOC processes. This is compounded by the fact that new catalysts can confer significant economic advantage for companies and this generates an understandable reluctance to reveal details.

REFERENCES

- Ameringer, G. E. (2000). # 117 "The gas/ethylene plant: concept and integration." Petroleum Technology Quarterly **Summer 2000**.
- Anastas & Warner (1998). # 44 Green Chemistry : Theory and Practice.
- Austria UBA (1999). # 64 Formaldehyde.
- Austria UBA (1999). # 65 Phthalic anhydride.
- Austria UBA (2000). # 94 Acetylene production.
- Austria UBA (2000). # 129 BTX production.
- Austria UBA (2000). # 131 Glyoxylic acid and other products of ozonolysis.
- Austria UBA (2000). # 97 Legislation.
- Austria UBA (2000). # 133 Lower Olefins.
- Austria UBA (2000). # 130 "Maleic anhydride." .
- Austria UBA (2000). # 95 Melamine production.
- Austria UBA (2000). # 134 MTBE.
- Austria UBA (2000). # 96 Oxygen containing hydrocarbons.
- Austria UBA (2000). # 93 Urea production.
- Bairlein, W. W. (1997). # 135 "Fackelloses anfahren von ethylenanlagen." Berichte aus technik und wissenschaft.
- CEFIC (1999). # 17 BAT for Producing Large Volume Organic Chemicals (Generic Part).
- CEFIC (1999). # 68 EDC/VCM Process BREF : Chapter 1 General Information.
- CEFIC (1999). # 70 EDC/VCM Process BREF : Chapter 3 Present consumption / emission levels.
- CEFIC (1999). # 66 Ethylene oxide / ethylene glycols Process BREF : Chapter 1 General Information.
- CEFIC (1999). # 67 "Ethylene oxide / ethylene glycols Process BREF : Chapter 2 Applied processes & techniques." .
- CEFIC (1999). # 43 Lower Olefins Process BREF : Chapter 1 General Information.
- CEFIC (1999). # 54 Lower Olefins Process BREF : Chapter 2 Applied processes & techniques.
- CEFIC (2000). # 85 Acrylonitrile Process BREF : Chapter 1 General Information.
- CEFIC (2000). # 86 Acrylonitrile Process BREF : Chapter 2 Applied processes & techniques.

References

- CEFIC (2000). # 107 Acrylonitrile Process BREF : Chapter 3 Present consumption / emission levels.
- CEFIC (2000). # 77 Aromatics Process BREF - Chapter 1 General Information.
- CEFIC (2000). # 113 Aromatics Process BREF - Chapter 3 Present consumption / emissions levels.
- CEFIC (2000). # 78 Aromatics Process BREF : Chapter 2 Applied processes & techniques.
- CEFIC (2000). # 112 Aromatics Process BREF : Chapter 4 Candidate BAT.
- CEFIC (2000). # 105 EDC/VCM Process BREF : Chapter 4 Candidate BAT.
- CEFIC (2000). # 103 Ethylene oxide / ethylene glycols Process BREF : Chapter 3 Present consumption / emission levels.
- CEFIC (2000). # 104 Ethylene oxide / ethylene glycols Process BREF : Chapter 4 Candidate BAT.
- CEFIC (2000). # 81 Formaldehyde Process BREF : Chapter 1 General Information.
- CEFIC (2000). # 82 Formaldehyde Process BREF : Chapter 2 Applied processes & techniques.
- CEFIC (2000). # 87 Formaldehyde Process BREF : Chapter 3 Present consumption / emission levels.
- CEFIC (2000). # 138 Formaldehyde Process BREF : Chapter 5 Best Available Techniques.
- CEFIC (2000). # 110 Lower Olefins Process BREF : Chapter 3 Present consumption / emission levels.
- CEFIC (2000). # 111 Lower Olefins Process BREF : Chapter 4 Candidate BAT.
- CEFIC (2000). # 140 Lower Olefins Process BREF : Crackers energy consumption survey (data revision for EIPPCB).
- CEFIC (2001). Application of BAT solutions to existing plants (Note 215).
- CEFIC (2001). Control of fugitive emissions generated by leaks in closed equipment and piping.
- CEFIC - Acrylonitrile Sector Group (1995). Guidelines for the distribution of acrylonitrile.
- CEFIC APPE (1998). # 15 APPE Annual Report - 1997-1998.
- CITEPA (1997). # 47 Workshop on best available techniques for the chemistry industry in Europe.
- Decroocq (1997). # 125 "Major scientific and technical challenges about development of new processes in refining and petrochemistry." Revue de l'institut francais du petrole **52**(5).
- EC (1993). # 41 Council regulation 1836/93 of 29 June 1993 allowing voluntary participation by companies in the industrial sector in a Community eco-management and audit scheme (EMAS).

- EC (1996). # 32 Council directive 96/82/EC of 9 December on the control of major-accident hazards involving dangerous substances.
- EC (1999). # 30 Council directive 1999/13/EC of 11 March 1999 on the limitation of emissions of volatile organic compounds due to the use of organic solvents in certain activities and installations.
- EC DGXI (1992). # 23 Identification and Brief Description of the Emissions (Water, Air and Wastes) from the Different Sectors of the Organic Chemical Industry European Commission, ChemInform.
- EC DGXI (1993). # 8 Technico-Economic Study on the Reduction Methods, Based on BAT of Industrial Emissions (Air, Water, Wastes) from the Basic Petrochemical Industry, WRc plc (Burchmore, S.; Ayscough, N.; Gendebien, A.. Et al).
- EC DGXI (1994). # 24 Technical and Economic Aspects of Measures to Reduce water Pollution Caused by the Discharge of Dibutyltin Compounds, Haskoning.
- EC DGXI, C. o. t. E. C. (1990). # 16 Technical Note on BAT not Entailing Excessive Cost for the Manufacture, Storage and Handling of Benzene, ERL.
- EC VOC Task Force (1990). # 116 Emissions of Volatile Organic Compounds (VOC) from stationary sources and possibilities of their control.
- Ecofys / AEA Technology (2001). Economic Evaluation of Sectoral Emission Reduction Objectives for Climate Change - Economic Evaluation of Carbon Dioxide and Nitrous Oxide Emission reductions in industry in the EU: 90.
- ECVM # 10 Industry Charter for the Production of VCM and PVC.
- ECVM (1994). # 11 The environmental impact of the manufacture of polyvinyl chloride (PVC) : A description of best available techniques, PVC Information Council.
- EEA, E. E. A. (1999). # 118 Website "Production processes".
- EEPC (2000). # 132 European Ethylene Producers Committee : Annual Conference, Rome.
- EIPPCB (2000). # 102 BREF on production of Iron and Steel.
- EIPPCB (Draft). # 52 BREF on Cross-media and Economic factors.
- EIPPCB (Draft). # 49 BREF on Emissions from Storage.
- EIPPCB (Draft). # 127 BREF on Large Combustion Plants.
- EIPPCB (Draft). # 51 BREF on Monitoring of emissions.
- EIPPCB (Draft). # 48 BREF on Wastewater and wastegas treatment / management for the chemical industry.
- ENDS Report (June 2000). # 119 "BASF: A world first in gasification." .
- Environment Agency (E&W) (1988). # 5 Best Available Techniques in the Fine and Speciality Organic Chemical Sector, WRc plc (Barry, M K et al.), WRc plc (Barry, M. K. et al).
- Environment Agency (E&W) (1995). # 14 The Categorisation of Volatile Organic Compounds.

Environment Agency (E&W) (1998). # 1 Best Available Techniques for the Control of Pollution in Petrochemicals and Large Volume Organic Chemical Processes, Chem Systems Limited.

Environment Agency (E&W) (1999). # 7 Large Volume Organic Chemicals (Process Guidance).

Environment Agency (E&W) (1999). # 6 Speciality Organic Chemicals (Process Guidance).

ETBP, E. T. B. P. P. (1996). # 63 Solvent capture for recovery and reuse from solvent-laden gas streams.

European Sealing Association (2001). LVOC Draft 2- Fugitive emission comments.

European Sealing Association (2001). Notes on 'Gas imaging'.

Eurostat (1997). # 31 Panorama of EU Industry 1997.

EVC Italia SpA (2000). # 124 EDC/VCM process BREF.

Federchimica (2000). # 122 Italian notes on BREF for the bulk organic chemicals - Aromatics.

Federchimica (2000). # 123 Italian notes on BREF for the bulk organic chemicals - Lower Olefins.

Finnish Environment Institute (1999). # 62 Environmental, health and safety activities during a processing plant project.

Finnish Environment Institute (1999). # 72 Draft Best Available Techniques Reference Document on the manufacturing of Phenol.

Finnish Environment Institute (1999). # 55 National information on loading and unloading.

Hicks, D. (2000). # 84 Chemical Plant : Design for decommissioning.

HMIP UK (1992). # 121 Pollution control for organic monomer processes.

HMIP UK (1993). # 100 Process Guidance Note IPR 4/17 - Bulk storage installations.

HMIP UK (1995). # 73 Di-isocyanate manufacture (Process Guidance Note IPR 6/4).

Hutcheson, P. B. (1995). # 61 "Innovation in process plant : a case study of ethylene." Journal of Product Innovation Management **12**(5): 415-440.

InfoMil (2000). # 83 Dutch notes on BAT for the Large Volume Organic Chemical industry.

Kent (1992). # 36 Riegel's Handbook of industrial chemistry.

Leendertsee (2001). Dutch environmental policy, legislation and regulations.

Linhoff, T. K. (1998). # 38 Intelligent networking of process wastewater streams in the chemical industry.

Meyers, R. A. (1986). # 74 Handbook of chemicals production processes.

- Nelson, N. E. (1992). # 45 Practical techniques for reducing waste. Industrial Environmental Chemistry. S. Martell.
- Noyes (1993). # 120 Pollution prevention technology handbook.
- Noyes, R. (1992). # 35 Handbook of leak, spill and accidental release prevention techniques.
- OSPAR (1998). # 79 “Decision 98/4 on emission and discharge limits for the manufacture of Vinyl Chloride Monomer (VCM) including the manufacture of 1,2-dichloroethane (EDC).” .
- PARCOM (1996). # 22 Best Available Techniques for the Vinyl Chloride Industry, Oslo and Paris Commissions Oslo and Paris Commissions.
- PARCOM (1996). # 21 PARCOM Recommendation 96/2 Concerning BAT for the Manufacture of Vinyl Chloride Monomer, Oslo and Paris Commissions Oslo and Paris Commissions.
- Randall, P. M. (1994). # 13 “Pollution Prevention Strategies for the Minimizing of Industrial Wastes in the VCM-PVC Industry.” Environmental Progress **13**(4): 269-277.
- Rentz, N., Laforsch, Holtmann (1999). # 114 Technical background document for the actualisation and assessment of UN/ECE protocols related to the abatement of the transboundary transport of VOCs from stationary sources., French-German Institute for environmental research.
- SEPA (2001). Target values for noise emission.
- SEPA, S. E. P. A. (2000). # 75 BAT in Swedish chemical industry - Generic.
- SEPA, S. E. P. A. (2000). # 76 Illustrative processes in Sweden.
- Sikdar & Howell (1998). # 101 “On developing cleaner organic unit processes.” Journal of Cleaner Production **6**: 253-259.
- Smith & Petela (1991). # 46 “Waste minimisation in the process industries (Parts 1 to 5).” The Chemical Engineer(Oct 91 to July 92).
- Stadelhofer, F. # 115 Industrial aromatic chemistry.
- Theodore & McGuinn (1992). # 37 Pollution prevention.
- UBA (Germany) (2000). # 143 Additional information on TDI.
- UBA (Germany) (2000). # 88 Compilation on wastewater discharges and abatement measures of LVOC productions.
- UBA (Germany) (2000). # 126 German proposals (on Bio Assays) for LVOC (Draft 1 Chapter 6.5.2).
- UBA (Germany) (2000). # 92 IPPC-BAT-Reference Document : Large Volume Organic Chemicals.
- UBA (Germany) (2000). # 89 Largest capacities of organic compounds in Europe.

References

- UBA (Germany) (2000). # 91 Ranges of compound concentrations in waste gases of large volume organic chemical industry.
- UBA (Germany) (2000). # 98 Summary of current German legislation relevant for the sectors of organic chemical industries.
- UBA (Germany) (2001). Substitution of chemical processes for the production of selected bulk and fine chemicals by biotechnological processes.
- UK CIA, C. I. A. (1991). # 39 Guidance on safety, occupational health and environmental protection auditing.
- UK IChemE, I. o. C. E. (1992). # 40 Waste Minimisation Guide.
- Ullmann (1998). # 80 Encyclopedia of industrial chemistry.
- USEPA (1993). # 136 Alternative control techniques document - NO_x emissions from process heaters.
- USEPA (1993). # 33 Control of volatile organic compound emissions from reactor processes and distillation operations processes in the synthetic organic chemical manufacturing industry.
- USEPA (1998). # 42 Waste minimisation opportunity assessment manual.
- USEPA, E. O. o. C. (1995). # 12 Sector Notebook Project - Profile of the Organic Chemical Industry.
- VITO, F. B. C. (1999). # 53 Briefing for LVOC TWG (13-14 April 1999).
- Weissermel & Arpe (1993). # 59 Industrial organic chemistry.
- Wells, G. M. (1991). # 60 Handbook of petrochemicals and processes.
- Wolf & Sorup (2000). The introduction of process integrated biocatalysts in companies - effect of dynamics in internal and external networks, IPTS.
- World Bank (1998). # 99 Pollution prevention & abatement handbook.

GLOSSARY OF TERMS AND ABBREVIATIONS

Abbreviations / Acronyms

AOX	Adsorbable Organic Halogens
API	American Petroleum Institute
BAT	Best available techniques
BOD	Biochemical Oxygen Demand
BREF	BAT Reference document
BTX	Benzene, Toluene, Xylene
CEFIC	Conseil Europeen de l'Industrie Chimique (European Chemical Industry Council)
CFC	Chlorofluorocarbon
CHP	Co-generation of heat and power
COD	Chemical Oxygen Demand
DEG	Di ethylene glycol
Dioxins	PCDD/PCDF compounds
EC	European Commission
EDC	Ethylene dichloride
EG	Ethylene glycol
EO	Ethylene oxide
EOX	Extractable Organic Halogens
EU	European Union
HCFC	Hydrochlorofluorocarbon
HVC	High Value Chemical
ISBL	Inside Battery Limits
IPPC	Integrated pollution prevention and control
LCP	Large combustion plants
LDAR	Leak Detection and Repair
LNB	Low-NOx Burner
LVOC	Large Volume Organic Chemicals
MDI	Methylene diisocyanate
MEG	Mono ethylene glycol
MTBE	Methyl tertiary butyl ether
Nameplate	Officially rated plant capacity
NMVOc	Non-methane volatile organic compounds
OSBL	Outside Battery Limits
PCDDs	Polychlorinated dibenzodioxins
PCDFs	Polychlorinated dibenzofurans
PVC	Polyvinyl chloride
SCR	Selective Catalytic Reduction
SNCR	Selective Non-Catalytic Reduction
TDA	Toluene dealkylation
TDI	Toluene diisocyanate
TEQ/iTEQ	(International) toxic equivalent of dioxins/furans
TOC	Total Organic Carbon
TEG	Tri ethylene glycol
TWG	Technical Working Group
UBA-D	Umweltbundesamt (Germany)
UBA-A	Umweltbundesamt (Austria)
ULNB	Ultra Low-NOx Burner
USEPA	United States Environmental Protection Agency

VCM	Vinyl chloride monomer
VOC	Volatile organic compounds
WEA	Whole Effluent Assessment
WWTP	Waste water treatment plant
WWWG	Waste water and waste gas (treatment / management)

Chemical symbols

C	Carbon
C _x	Organic compounds (where x = number of carbon atoms)
Cl ₂	Chlorine
CO ₂	Carbon dioxide
H ₂	Hydrogen
HCl	Hydrochloric acid
H ₂ S	Hydrogen sulphide
H ₂ SO ₄	Sulphuric acid
N ₂	Nitrogen
NO _x	Nitrogen oxides
SO _x	Sulphur oxides
SO ₂	Sulphur dioxide

Prefixes

n	nano	10 ⁻⁹
μ	micro	10 ⁻⁶
m	milli	10 ⁻³
c	centi	10 ⁻²
k	kilo	10 ³
M	mega	10 ⁶
G	giga	10 ⁹

Units

bar	bar (1.013 bar = 1 atm)
barg	bar gauge (bar + 1 atm)
billion	1000 million
°C	degree Celsius
g	gram
h	hour
kg	kilogram
kPa	kilo Pascal
ktpa	kilo tonnes per annum
kWh	kilowatt-hour (3.6 MJ)
l	litre
m	metre
mg	milligram
m ²	square metre
m ³	cubic metre
Mtpa	Million tonne per annum
Nm ³	Normal m ³ (gas, 273 K, 101.3 kPa)
pa	per annum (per year)
Pa	Pascal
ppb	parts per billion
ppm	parts per million
ppmv	parts per million (by volume)
s	second
t	tonne
tpa	tonnes per annum
vol% / % v/v	Percentage by volume
wt% / % w/w	Percentage by weight

ANNEX I: MEMBER STATE LVOC EMISSION LIMITS

The following sections summarise the emission limits that are applied to the LVOC industry in Member States. Some of these limits are found in national or regional legislation, whilst others are technical guidelines for the derivation of permit conditions. In many cases the limits have been derived from the application of best practices and may be synonymous with BAT.

Note that there may be markedly different criteria behind the figures, and attention should be paid to such factors as averaging time; reference conditions; techniques of sampling, measurement and analysis; and method of compliance testing. Many of the emission limit values are also for application to actual environmental releases and this may be achieved by common end-of-pipe treatment units into which individual LVOC processes may only contribute a small part.

This Annex contains information submitted by:

- A. United Kingdom
- B. Germany
- C. Austria
- D. The Netherlands
- E. Sweden

A. United Kingdom

UK emission limits for the LVOC sector are found in Technical Guidance Notes [Environment Agency (E&W), 1999 #7] [Environment Agency (E&W), 1988 #5]. The notes identify the best available techniques for pollution prevention and control, and the environmental release levels achievable by their use in new processes. In conjunction with other guidance material and site specific factors, the information is used to set permit conditions concomitant with BATNEEC (Best Available Techniques Not Entailing Excessive Cost) and BPEO (Best Practicable Environmental Option).

WATER EMISSIONS - UK [Environment Agency (E&W), 1999 #7]	Benchmark release levels (mg/l) ⁽¹⁾
Total hydrocarbon oil content (IR method)	1 - 3
Biological oxygen demand (BOD) (5 day ATU @ 20 °C)	20 - 30
Chemical oxygen demand (COD) (2 hour)	100 - 150
Total nitrogen (as N)	10 - 15
Suspended solids (dried @ 105,C)	20 - 30
Notes:	
1. As flow weighted monthly averages.	
2. EC Directive 90/415/EEC gives limits for releases to water from the production and use of 1,2-dichloroethane, trichloroethylene, perchloroethylene and trichlorobenzene.	

AIR EMISSIONS - UK	Benchmark release levels for air emissions (mg/m ³) ⁽¹⁾⁽²⁾							
	Petro-chemicals	Nitrogen compounds	Acid & aldehydes	Sulphur compounds	Monomers	Organo metallic compounds	Sulphonation & nitration	Halogenation
	[Environment Agency (E&W), 1999 #7]					[Environment Agency (E&W), 1988 #5]		
Acrylamide		5						
Acrylonitrile		5			5			
Amines (total as DMA)		10			10			10
Ammonia	15	15	15					
Benzene	5	5					5	5
Bromine				10			10	10
Butadiene	5				5			
Cadmium & compounds (as Cd)	0.1	0.1						
Carbon disulphide		5		5				
Carbon monoxide	100	100	100	100	100		100	100
Chlorine			10		10		10	10
1,2-dichloroethane					5			5
Ethylene oxide	5							
Formaldehyde			5		5			5
Hydrogen bromide			5		5		5	5
Hydrogen chloride	10	10	10	10	10		10	10
Hydrogen cyanide		2						
Hydrogen fluoride				5			5	
Hydrogen iodide			5	5			5	5
Hydrogen sulphide	5	5	5	5				
Heavy metals (exc. Hg, Cd)	1.5					20		
Iodine				10			10	
Maleic anhydride			5		5			
Mercury & compounds (as Hg)	0.1	0.1						
Methyl mercaptan				2				
Nitrobenzene		5					5	
Organic sulphides & mercaptans		2		2	2			
Oxides of nitrogen (total acid forming as NO ₂)	200		200	200	200		200	200
Oxides of sulphur (as SO ₂)			200	200			200	200
Particulate matter	20	20	20	20	20	20	20	20
Phenols, cresols & xylols (as phenol)			10		10			10
Trimethylamine		2						
Vinyl chloride					5			5
VOC – Total Class A ⁽³⁾	20	20	20	20	20	20	20	20
VOC - Total Class B (as toluene) ⁽⁴⁾	80	80	80	80	80	80	80	80

1. The reference conditions applicable to these levels are: temperature 273 K (0 °C), pressure 101.3 kPa (1 atmosphere), no correction for water vapour or oxygen.
2. Where the term 'expressed as' is used, a correction should be carried out using the ratio of the atomic or molecular weights of the substances as appropriate.
3. Applies when the total mass release of Class A VOCs exceeds 100 g/h
4. Applies when the total mass release of Class B VOCs exceeds 5 tonnes/yr or 2 kg/h, whichever is the lower (expressed as toluene)

B. Germany

B1: Air Quality [UBA (Germany), 2000 #98]

The Technical Instructions on Air Quality (TA Luft) are general administrative regulations that specify the requirements to be met by installations subject to licensing. TA Luft prescribes limit values for virtually all air pollutants as well as structural and operational requirements designed to limit diffuse emissions. The TA Luft emission limit values represent the state of the art for technical measures for reducing emissions. These values were developed from scientific findings and research taking into account toxicological, bio-accumulative and epidemiological aspects. Since the TA Luft stems from 1986, local authorities sometimes demand stricter emission limit values. The following tables show the limits for general emission control and the more specific requirements for organic chemical sectors. It has to be noted that the TA Luft is currently under amendment, including a decrease of the emission limit values, especially for the carcinogenic, the organic, and partly the inorganic substances.

General emission control requirements laid down in the TA Luft

Emitted substance (TA Luft section)	Class	Substances	Notes	Mass flow threshold (g/h)	Concentration limit (mg/m ³) ⁽²⁾
Total dust (3.1.3)	-			<= 500 >= 500	150 50
Inorganic dust particles (3.1.4)	I	Hg, Cd, Tl	Sum of substances	>= 1	0.2
	II	As, Co, Ni, Te, Se	Sum of substances	>= 5	1
	III	e.g. Sb, Pb, Cr, CN, F, Cu, Mn, Pt, Pd, Rn, V, Sn & substances which are strongly suspected to cause cancer	Sum of substances	>= 25	5
	I+II		Sum of substances		1
	I+III, II+III		Sum of substances		5
Vaporous or gaseous inorganic substances (3.1.6)	I	(e.g. AsH ₃)	per substance	>= 10	1
	II	(e.g. HF, Cl ₂ , H ₂ S)	per substance	>= 50	5
	III	(e.g. Cl-compounds as HCl)	per substance	>= 300	30
	IV	(e.g. SO ₂ + SO ₃ as SO ₂ , NO + NO ₂ as NO ₂)	per substance	>= 5000	500
Organic substances (3.1.7)	I	(e.g. Chloromethane)	Classification according to Annex E of TA Luft	>= 100	20
	II	(e.g. Chlorobenzene)		>= 2000	100
	III	(e.g. Alkylalcohols)		>= 3000	150
Vaporous or gaseous emissions during treatment and refilling of organic substances (3.1.8)	Requirements for the minimisation of diffuse organic emission by the installation of technical equipment, e.g. pumping units, compressors, flanged joints, stop valves and in sampling stations				
Carcinogens (2.3)	I	e.g. Cd ⁽¹⁾ , As ⁽¹⁾ , asbestos, benzo(a)pyrene	sum of substances	≥ 0.5	0.1
	II	e.g. Ni, chromium VI	sum of substances	≥ 5	1
	III	e.g. acrylonitrile, benzene	sum of substances	≥ 25	5
1. Based on the decision adopted by the Conference of the Federal Government/Federal States Ministers for the Environment on 21/22 November 1991, an emission concentration value of 0.1 mg/m ³ has been stipulated for Cd and its compounds, given as Cd, as well as for As and its compounds, given as As. 2. Concentration limits are the mass of emitted substances related to the volume of emitted gas under standard conditions (0 °C, 1013 mbar) after subtraction of the water vapour content. 3. If organic substances in several classes are present, the mass concentration in the emitted gas should not exceed a total of 0.15 g/m ³ with a total mass flow of 3 kg/h or more.					

Organic substances: Chapter 3.1.7 of the TA – Luft gives maximum emission values for three different classes of organic compounds on the basis of their the hazard. The most dangerous substances (Class 1) are limited to 20 mg/m³. The maximum emission values for Class 2 and 3 are 100 mg/m³ and 150 mg/m³. The allocation of substances to the different classes is made in Annex E of the TA-Luft and the table below presents examples of substances from each of the different classes. Substances which are not listed in Annex E should be allocated to the same class as the substance which has the most similar effect on the environment.

Examples for emission limits for organic substances {TA – Luft, 1986}

Substances		
Class 1	Class 2	Class 3
mass flow ≥ 0.1 kg/h	mass flow ≥ 2 kg/h	mass flow ≥ 3 kg/h
acetaldehyde	acetic acid	acetone
aniline	butyraldehyde	2-butanone
chloroform	carbon disulphide	dibutylether
1,2 dichloroethane	chlorobenzene	dichloromethane
diethylamine	cyclohexanone	dimethylether
ethylamine	dimethyl formamide	ethyl acetate
formaldehyde	ethyl benzene	ethanol
formic acid	propionic acid	N-methylpyrrolidone
maleic anhydride	toluene	olefins (except 1,3-butadiene)
methyl chloride	ethylene glycol	paraffins (except methane)
phenol	xylene	trichlorofluoromethane
trichlorethylene		
vinyl acetate		
$\Sigma 20$ mg/m ³	$\Sigma 100$ mg/m ³	$\Sigma 150$ mg/m ³

Specific TA Luft emission control requirements for organic chemical industry

Sector	Requirements
Production of 1,2 – dichloroethane (EDC) and vinylchloride (VC) (3.3.4.1.g.1)	Limit emission concentration: 5 mg EDC or VC /m ³
Production of acrylonitrile (AN) (3.3.4.1.g.2)	Limit emission concentration: 0.2 mg AN /m ³ Waste gases from distillation or refilling have to be reduced

There are also special measures and/or regulations for existing maleic anhydride and ethyl benzene production plants, and for CHFC plants. For the production of hydrocarbons the special measures for refineries have to be considered [Austria UBA, 2000 #97].

Monitoring. TA-Luft gives guidance on the measurement of emission from some plants. For dust-like, gaseous and vaporous emissions there is a requirement for continuous measurement when certain mass flows are exceeded.

Mass flow thresholds for continuous measurement [Austria UBA, 2000 #97]	
Component	Mass flow
Sulphur dioxide	50 kg/h
Nitric oxide and nitrogen dioxide (calculated as nitrogen dioxide)	30 kg/h
Carbon monoxide (if it is used to assess the completeness of combustion)	5 kg/h
Carbon monoxide (in all other cases)	100 kg/h
Fluorine and its gaseous compounds (calculated as hydrogen fluoride)	0.5 kg/h
Gaseous inorganic chlorine compounds (calculated as hydrogen chloride)	3 kg/h
Chlorine	1 kg/h
Hydrogen sulphide	1 kg/h
Sum of class 1 organic substances (calculated as total organic carbon)	1 kg/h
Sum of class 1, 2 and 3 organic substances (calculated as total organic carbon)	10 kg/h
Dust – continuous measurement	5 kg/h
Dust – exhaust gas obscuration	2 –5 kg/h

No daily mean value of the respective emitted substances should exceed the required emission limits, 97 % of all half-hourly means should not exceed six fifths of the required emission limits, and all half-hourly means should not exceed the required emission limits by more than twice.

B2: Water emissions

The Federal Water Act (Wasserhaushaltsgesetz – WHG) applies to waste water generated by various industrial processes. Discharges into water are regulated by the Waste water Ordinance (including Annexes) which specifies the minimum requirements when granting a permit to discharge waste water from the source categories listed in the Appendices into a waterbody.

These minimum requirements are binding for the authorities responsible for licensing discharges, and even more stringent requirements can be imposed where required by local conditions. The minimum requirements are based on the 'emission principle' and the precautionary principle, i.e. application of stringent, technically derived emission standards irrespective of the loading reserves of the receiving water or the potential effects of the various substances discharged. The general requirements of the waste water Ordinance can be found in [UBA (Germany), 2000 #98]. In addition, there are specific annexes that deal with the Chemical Industry and the Production of Hydrocarbons.

Appendix 22 on 'Chemical industry'

"A. Scope of application

(1) This Appendix shall apply to waste water originating primarily from the production of substances using chemical, biochemical or physical techniques, including the related pre-treatment, intermediate treatment and after-treatment.

(2) This Appendix shall not apply to waste water discharges of less than 10 m³ per day.

(3) For waste water derived from formulation (i.e. the manufacture of substances and preparations by blending, dissolving or bottling) which is discharged without being blended with other waste water falling under the scope of application of this Appendix, only part B of this Appendix shall apply.

B. General requirements

A permit for the discharge of waste water into waterbodies shall only be granted, subject to the requirement that the contaminant load at the site of occurrence of the waste water is kept as low as the following measures permit, after investigating the situation in each individual case:

- Use of water-saving techniques, such as counter-current washing
- Multiple use and recirculation, e.g. with washing and purifying processes
- Indirect cooling, e.g. to cool vapour phases instead of using jet condensers or jet coolers.
- The use of waste water-free techniques to generate vacuums and for waste air purification
- The retention or recovery of substances via the preparation of mother liquor and by means of optimised techniques
- The use of low-pollutant raw and auxiliary materials.

Proof of compliance with the general requirements shall be furnished in the form of a waste water register.

C. Requirements for waste water at the point of discharge

(1) The following requirements apply to the waste water at the point of discharge into the waterbody:

1. Chemical oxygen demand (COD)

For waste water flows whose COD concentration at the site of occurrence of waste water is

- a) more than 50000 mg/l, a COD concentration of 2500 mg/l shall apply
- b) more than 750 mg/l, a COD concentration equivalent to a 90 % reduction in COD shall apply
- c) 750 mg/l or less, a COD concentration of 75 mg/l shall apply
- d) less than 75 mg/l, the actual COD concentration at the site of occurrence shall apply.

The requirements shall also be deemed to have been met provided a COD concentration of 75 mg/l in the qualified random sample or 2-hour composite sample is adhered to, with due regard for part B.

2. Total nitrogen as the sum of ammonia, nitrite and nitrate nitrogen (N_{tot}): 50 mg/l in the qualified random sample or 2-hour composite sample. A higher concentration of up to 75 mg/l may be specified in the water discharge licence, provided a 75 % reduction in the nitrogen load is adhered to. The set value shall also be deemed to have been met, provided the level defined as 'total bonded nitrogen (TN_b)' is adhered to.

3. Total phosphorous: 2 mg/l in the qualified random sample or 2-hour composite sample. This requirement shall also be deemed to have been met provided the level defined as 'phosphorous compounds as total phosphorous' is adhered to.

4. Toxicity

Fish toxicity	T_F	=	2
Daphnia toxicity	T_D	=	8
Algae toxicity	T_A	=	16
Luminescent bacteria test	T_L	=	32
Mutagenic potential (umu test)	T_M	=	1.5

The requirements refer to the qualified random sample or the 2-hour composite sample.

(2) If process-integrated measures are applied to reduce the COD load by arrangement with the water authority, then the decisive load prior to implementation of the measure shall be used as a basis.

(3) For chemical oxygen demand (COD), the total load in 0.5 or 2 hours shall be limited in the water discharge licence. The total load is the sum of the individual loads from the individual waste water flows. The total load which must not be exceeded refers to the concentration in the qualified random sample or 2-hour random sample and the volumetric flow of waste water in 0.5 or 2 hours corresponding to sampling.

D. Requirements on waste water prior to blending

(1) The following requirements apply to waste water prior to blending with other waste water:

Adsorbable organic halogens (AOX)	
a) Waste water from the manufacture of epichlorohydrin, propylene oxide and butylene oxide	3 mg/l
b) Waste water from the two-stage manufacture of acetaldehyde	80 g/t
c) Waste water from the single-stage manufacture of acetaldehyde	30 g/t
d) Waste water from the manufacture of AOX-relevant organic colorants and aromatic intermediate products, where these are predominantly used to manufacture organic colorants	8 mg/l
e) Waste water from the manufacture of AOX-relevant active pharmaceutical ingredients	8 mg/l
f) Waste water from the manufacture of Cl chlorinated hydrocarbons by means of methane chlorination and methanol esterification, and of carbon tetrachloride and perchloroethane by means of perchlorination	10 g/t
g) Waste water from the manufacture of 1,2 dichloroethane (EDC), including further processing to vinyl chloride (VC) (note: The load level refers to the production capacity for purified EDC. The capacity should be specified with due regard for the EDC portion which is not cracked in the VC unit linked to the EDC production unit and which is returned to the production cycle in the EDC purification plant.	2 g/t
h) Waste water from the manufacture of polyvinyl chloride (PVC)	5 g/t
i) Waste water flows with an AOX concentration of more than 0.1 mg/l and less than 1 mg/l without targeted measures	0.3 mg/l
j) Waste water flows from the manufacturing, further processing and application of substances which are not separately regulated elsewhere with a concentration of more than 1 mg/l is exceeded or less than 1 mg/l via targeted measures	1 mg/l or 20 g/t
The load level refers to the capacity of the organic target products. It does not apply to the application of substances.	

Other substances	Qualified random sample or 2-hour composite sample (mg/l)	
	I	II
Mercury	0.05	0.001
Cadmium	0.2	0.005
Copper	0.5	0.1
Nickel	0.5	0.05
Lead	0.5	0.05
Total chromium	0.5	0.05
Zinc	2	0.2
Tin	2	0.2

The requirements in column I apply to waste water flows from the manufacturing, further processing or application of these substances. The requirements in column II refer to waste water flows not originating from the manufacturing, further processing or application of these substances but which are nevertheless contaminated with such substances below the concentration levels in column I.

(2) Upon compliance with the AOX requirements and the general requirements pursuant to part B, the requirements of Appendix 48, part 10 shall also be deemed to have been met.

(3) The AOX requirements shall not apply to iodo-organic substances in waste water from the manufacturing and bottling of X-ray contrast media.

(4) For adsorbable organic halogens (AOX) and the substances limited in paragraph (1), number 2, the total load per parameter in 0.5 or 2 hours shall be limited in the water discharge licence. The respective total load is derived from the sum of the individual loads of the separate waste water flows. The total load which must not be exceeded refers to the concentration in the qualified random sample or 2-hour composite sample and the volumetric flow of waste water in 0.5 or 2 hours corresponding to sampling.

(5) A waste water flow may only be blended with other waste water, subject to the furnishing of proof that the load of total organically bonded carbon (TOC) in this waste water flow ascertained for the site of occurrence is reduced by 80 % overall. This requirement shall not apply where the residual TOC load discharged from the respective waste water flow into waterbodies does not exceed 20 kilograms per day or 300 kilograms per year or 1 kilogram per tonne of production capacity of the organic target product. When proving the reduction in load, in the case of physico-chemical waste water treatment plants, the TOC elimination level of such plants shall be used as a basis, whereas in the case of biological waste water treatment plants, the result of a study pertaining to number 407 of the Annex to Article 4 shall be used as a basis.

E. Requirements on the waste water at the site of occurrence

(1) For chromium VI, a concentration of 0.1 mg/l in the random sample shall be adhered to.

(2) For volatile organically bonded halogens, a concentration of 10 mg/l in the random sample shall be adhered to. This requirement shall be deemed to have been met, provided it is achieved prior to the inlet into a sewage system without prior risk of leakage losses and without the waste water having been diluted.

F. Requirements for existing discharges

(1) For existing discharges of waste water from installations which were lawfully in operation prior to 1 January 1999 or whose construction had lawfully commenced by this date, the provisions in parts A, B, C and D shall only apply insofar as no requirements to the contrary are specified in paragraphs (2) to (5).

(2) Notwithstanding part B, proof of compliance with the general requirements in a waste water register must only be provided for 90 % of the parameter-related total loads in each case. The use of waste water-free techniques to generate a vacuum and for waste air purification must only be tested for the parameters specified in parts D and E. Additional testing with respect to other parameters is unnecessary.

(3) The requirements of part C pertaining to COD shall not apply to waste water from the manufacture of polyacrylonitrile.

(4) Notwithstanding part D, the following AOX requirements shall apply to the following waste water flows prior to blending with other waste water:

- Waste water from the production of EDC, including further processing to VC: 5 g/t (production capacity of purified EDC)
- Waste water from the manufacture of PVC: 1 mg/l or 20 g/t

(5) The requirements concerning mutagenic potential (umu test) pursuant to part C, paragraph (1) and TOC pursuant to part D, paragraph (5) shall not apply.”

Appendix 36 on ‘Production of hydrocarbons’

“A. Scope of application

(1) This Appendix shall apply to waste water whose contaminant load originates primarily from the following areas of hydrocarbon production:

The production of certain hydrocarbons, primarily olefin hydrocarbons, with 2 to 4 carbon atoms, as well as benzene, toluene and xylene from mineral oil products by cracking with the aid of steam (steam cracking).

The production of pure hydrocarbons or certain blends of hydrocarbons from mineral oil products using physical separation methods.

The conversion of hydrocarbons into other hydrocarbons using the chemical techniques of hydration, dehydration, alkylation, dealkylation, hydrodealkylation, isomerisation or disproportionation.

This shall also include any precipitation water coming into contact with hydrocarbons in the process area of the production plant.

(2) This Appendix shall not apply to waste water from the production of pure paraffins from slack wax, from petroleum refining, from indirect cooling systems or from process water treatment facilities.

B. General requirements

No requirements above and beyond Article 3 are imposed.

C. Requirements for waste water at the point of discharge

(1) The following requirements apply to the waste water at the point of discharge into the waterbody:

	Qualified random sample or 2-hour composite sample (mg/l)
Chemical oxygen demand (COD)	120
5-day biochemical oxygen demand (BOD ₅)	25
Total nitrogen (as sum of ammonia, nitrite and nitrate nitrogen (N _{tot}))	25
Total phosphorous	1.5
Total hydrocarbons	2

(2) For COD, a concentration of up to 190 mg/l in the qualified random sample or 2-hour composite sample may be conceded, provided the COD load is reduced by at least 80 % in a central waste water treatment plant. The reduction in COD load refers to the ratio between the COD load in the effluent of the gravity-type oil-water separator and that of the effluent from the biological waste water treatment plant over a representative period of time not exceeding 24 hours.

(3) For total nitrogen, a higher concentration is permissible, provided the nitrogen load is reduced by at least 75 % in a central waste water treatment plant. The reduction in the nitrogen load refers to the ratio between the nitrogen load of the effluent from the gravity-type oil-water separator and that of the effluent from the biological waste water treatment plant over a representative period of time which should not exceed 24 hours. Total bonded nitrogen (TN_b) should be used as a basis when calculating the loads.

D. Requirements on waste water prior to blending

The following requirements shall apply to the waste water prior to blending with other waste water:

	Qualified random sample or 2-hour composite sample (mg/l)	Random sample (mg/l)
Adsorbable organic halogens (AOX)	-	0.1
Phenol index after distillation and dye extraction	0.15	-
Benzene and derivatives	0.05	-
Sulphide sulphur and mercaptan sulphur	0.6	-

If hydrocarbon production also includes the manufacture of ethylbenzene and cumene, an AOX level of 0.15 mg/l shall apply.

E. Requirements on waste water for the site of occurrence

Waste water from the production of ethylbenzene and cumene must not exceed a level of 1 mg/l for adsorbable organic halogens (AOX) in the random sample."

C. Austria

C1: Air emissions [Austria UBA, 2000 #97]

Austria has no special legislation on air emission standards for the chemical industry. In general the 'Gewerbeordnung' (BGBl. 194/1994) regulates the licensing of chemical plants and requires plants to use state-of-the-art in their performance. Emission standards for air emissions from chemical plants are usually based on the German 'Technical Instructions on Air Quality' (TA Luft). The separate ordinances on combustion plants and steam boilers are outlined below. Where no Austrian regulations exist, the German TA Luft is used as a permitting guideline.

1. Feuerungsanlagenverordnung (Ordinance for Firing Installations) (BGBl. II 1997/331)

This ordinance regulates emissions of combustion plants with a nominal thermal output of 50 kW or more. It does not regulate steam boilers inclusive waste heat boilers, after-burning of exhaust gases, gas turbines, combustion engines and plants using waste as fuel. Different emission standards are given for fuel type and thermal output of the unit.

1.1 Coal and coke fired plants:

Pollutant		Capacity (MW)					
		≤ 0.35	> 0.35 - 1	> 1 - 2	> 2 - 10	> 10 - 50	> 50
Dust	mg/m ³	150	150	150	50	50	50
SO ₂	mg/m ³	-	-	-	-	400	200
CO	mg/m ³	1 000	1 000	150	150	150	150
NOx	mg/m ³	-	400	400	400	350	100

The capacity is defined as the average of the hourly added amount of heat related to the calorific value of the fuel
The emission standards are related to dry exhaust gas at 0 °C, pressure of 1 013 kPa and oxygen content of 6 %.

1.2 Oil fired plants:

The sulphur content of the four different kinds of heating oil is laid down in the Verordnung über den Schwefelgehalt von Heizölen (BGBl. 1989/94 i.d.F. BGBl. 1994/545).

Type of heating oil	Maximum sulphur content
Heating oil extra light	0.10 mass %
Heating oil light	0.20 mass %
Heating oil medium	0.60 mass %
heavy fuel	1.00 mass %

For the smallest firing installations there are restrictions on the quality of heating oils to be fired. Heating oils with a higher sulphur content may be used in an installation with a lower power rating if equal SO₂ emission levels are guaranteed by other measures.

Capacity	Heating oil allowed
≤ 0.07 MW	Extra light
> 0.07 – 5 MW	Extra light / light
5 – 10 MW	Extra light / light /medium
> 10 MW	All kinds of heating oils

Under BGBl. II 1997/331, some of the emission standards are different for the different kinds of heating oils. The emission standards for liquid fuels all relate to dry exhaust gas at 0 °C, a pressure of 1013 kPa and an oxygen content of 3 % in the exhaust gas.

Dust emission standards (as mg/m ³) when using heating oils as fuel			
Fuel	Capacity (MW)		
	> 2 – 30 MW	> 30 – 50 MW	> 50 MW
Heating oil extra light	30	30	30
Heating oil light	50	35	35
Heating oil medium	60	50	35
Heavy fuel	60	50	35

SO ₂ emission standards (as mg/m ³) when using heating oils as fuel		
Pollutant	Capacity (MW)	
	> 50 – 300 MW	> 300 MW
SO ₂	350	200

CO emission standards (as mg/m ³) when using heating oils as fuel		
Pollutant	Capacity (MW)	
	≤ 1 MW	> 1 MW
CO	100	80

NO _x emission standards (as mg/m ³) when using heating oils as fuel				
Fuel	Capacity (MW)			
	≤ 3 MW	> 3 – 10 MW	> 10 – 50 MW	> 50 MW
Heating oil extra light	150	150	150	100
Heating oil light	450	400	350	100
Heating oil medium	450	450	350	100
Heavy fuel	450	450	350	100

1.3 Gas fired plants:

For plants using gaseous fuels (natural gas or liquefied petroleum gas) there are only emission standards for NO_x and CO.

Emissions standards for gaseous fuels			
Pollutant	Fuel	Capacity (MW)	
		≤ 3 MW	> 3 MW
CO (mg/m ³)	Natural gas	80	80
	Liquefied petroleum gas	80	80
NO _x (mg/m ³)	Natural gas	120	100
	Liquefied petroleum gas	160	130

The emission standards are related to dry exhaust gas at 0 °C, a pressure of 1013 kPa and an oxygen content of 3 %. For firing places with high temperature processes higher NO_x emissions are allowed. Using natural gas 200 mg/m³ NO_x and using liquefied petroleum gas at maximum 260 mg/m³ NO_x are allowed.

The requirement for continuous measurements of different pollutants depends on the fuel type and on plant capacity.

Thresholds above which continuous measurement is required				
Fuel	Dust	CO	SO ₂	NO _x
Solid	> 10 MW	> 10 MW	> 30 MW	> 30 MW
Liquid	> 10 MW	> 10 MW	> 50 MW	> 30 MW
Gaseous	-	> 10 MW	-	> 30 MW

2. Luftreinhaltegesetz and Luftreinhalteverordnung für Kesselanlage (Clean Air Act and Clean Air Ordinance for Steam Boilers) (LRG-K and LRV-K)

Limits exist for emissions of dust, SO₂, CO and NO_x from steam boilers and waste heat boilers

Dust emission standards (as mg/m³)				
Fuel	Capacity (MW)			
	< 2 MW	2 – 30 MW	30 – 50 MW	> 50 MW
Solid fuels	150	50		
Gaseous fuels	-	5	5	5
Heating oil extra light	-	30	30	30
Heating oil light	-	50	35	35
Heating oil medium	-	60	50	35
Heavy fuel	-	60	50	35

SO₂ emission standards (as mg/m³)			
Fuel	Capacity (MW)		
	10 – 50 MW	50 – 300 MW	> 300 MW
Brown coal	400	400	400
Other solid fuels	400	200	200
Liquid fuels	1700	350	200

CO emission standards (as mg/m³)		
Fuel	Capacity	
	≤ 1MW	> 1MW
Solid fuels	1000	150
Liquid fuels	100	80
Liquefied petroleum gas	100	
Natural gas	80	

NO_x emission standards (as mg/m³)				
Fuel	Capacity			
	0.35 – 3 MW	3 – 10 MW	10 – 50 MW	> 50 MW
Solid fuels	400		350	200
Gaseous fuels	125	100		
Heating oil extra light	150			
Heating oil light	450	400	350	100
Heating oil medium	450		350	100
Heavy fuel	450		350	100

The emission standards for solid fuels are related to 6 % oxygen in the exhaust gas. For liquid and gaseous fuels they are related to 3 % oxygen. All emission values are related to dry exhaust gas at 0 °C and a pressure of 1013 mbar.

C2: Water emissions [Austria UBA, 2000 #97]

In addition to the general ordinance on waste water discharges ('Allgemeine Abwasseremissionsverordnung' BGBl. 1996/186), there are specific ordinances for plants producing LVOC. The relevant emission limits are:

Emission standards for the production of hydrocarbons (BGBl. II 1999/7)		
General parameters	Discharge to running waters	Discharge to public sewage system
Temperature	30 °C	40 °C
Toxicity to algae G_A	8	no impairment of the public waste water treatment plant
Toxicity to bacteria G_L	4	
Toxicity to daphnia G_D	4	
Toxicity to fish G_F	2	
Filterable matter	30 mg/l	150 mg/l
pH – value	6.5 – 8.5	6.5 – 10
Inorganic parameters		
Aluminium (calculated as Al)	2 mg/l	limited with the standard for filterable substances
Lead (calculated as Pb)	0.5 mg/l	0.5 mg/l
Iron (calculated as Fe)	3.0 mg/l	limited with the standard for filterable substances
Copper (calculated as Cu)	0.5 mg/l	0.5 mg/l
Nickel (calculated as Ni)	0.5 mg/l	0.5 mg/l
Mercury (calculated as Hg)	0.01 mg/l	0.01 mg/l
Zinc (calculated as Zn)	1 mg/l	1 mg/l
Tin (calculated as Sn)	1 mg/l	1 mg/l
Ammonium (calculated as N)	5 mg/l	
Chloride (calculated as Cl)	limited with standards for toxicity	
Cyanide (easily released & calculated as CN)	0.1 mg/l	0.5 mg/l
Fluoride (calculated as F)	30 mg/l	30 mg/l
Total bound nitrogen (including ammonium, nitrite and nitrate nitrogen)	40 mg/l	-
Total phosphorus (calculated as P)	2 mg/l	-
Sulphate (calculated as SO_4)	-	200 mg/l
Sulphide (easily released and calculated as S)	0.5 mg/l	1 mg/l
Organic parameters		
Total organic carbon (calculated as C)	25 mg/l	-
COD (calculated as O_2)	75 mg/l	-
BOD ₅ (calculated as O_2)	20 mg/l	-
AOX (calculated as Cl)	0.5 mg/l	0.5 mg/l
Sum of hydrocarbons	5 mg/l	20 mg/l
POX (calculated as Cl)	0.1 mg/l	0.1 mg/l
Phenol index (calculated as phenol)	0.2 mg/l	20 mg/l
Sum of anionic and non ionic tensides	2 mg/l	no impairment of the public waste water treatment plant
Sum of volatile aromatics (BTXE)	0.1 mg/l	1 mg/l

Emission limits for the production of several organic substances (BGBl. II 1999/7)		
Substance	Emission standard	
	mg/l	g/tonne installed production capacity
Ethylbenzene, cumene	1.0	20
Acetaldehyde, vinyl acetate	1.0	30
Vinyl chloride	1.0	2
Trichlorophenols (TCP, all isomers)	1.0	20
Trichlorobenzenes (TCB, all isomers)	0.2	2
Tetrachloromethane	1.5	3
Hexachlorobutadiene (HCBd)	1.5	2
Ethane 1,2 dichloride (EDC)	1.0	2
Trichlorethylene (TRI)	1.0	3
Perchloroethylene (PER)	1.0	3
Halogenated organic solvents except: 1,2,4, trichlorobenzene and items 6 – 11	1.0	10

Compliance with emission limits is achieved if four of five successive measured values are lower than the emission limit and if any failure does not exceed the emission limit by more than 50 %. Most of the parameters have to be determined with mass proportional homogeneous daily average samples. The parameters temperature, filter out matter, pH – value, cyanide, sulphide, POX and sum of volatile aromatics (BTXE) have to be determined with random samples.

Specific ordinances also exist for waste water emission from the production of acetylene, and melamine / urea.

Emission standards for the production of acetylene from calcium carbide (BGBl. 1996/670)		
General parameters	Discharge to running waters	Discharge to public sewage system
Temperature	35 °C	40 °C
Toxicity to bacteria G _L	4	No impairment of the public waste water treatment plant
Toxicity to fish G _F	2	
Filter out matter	50 mg/l	
pH – value	6.5 – 9	6.5 – 10
Inorganic parameters		
Iron (calculated as Fe)	2 mg/l	Limited with the standard for filterable substances
Ammonium (calculated as N)	10 mg/l	-
Cyanide (easy to release and calculated as CN)	0.1 mg/l	0.1 mg/l
Total phosphorus (calculated as P)	1 mg/l	-
Sulphate (calculated as SO ₄)	-	200 mg/l
Sulphide (calculated as S)	0.1 mg/l	1 mg/l
Sulphide (calculated as SO ₃)	1 mg/l	10 mg/l
Organic parameters		
COD (calculated as O ₂)	50 mg/l	-
Sum of hydrocarbons	10 mg/l	20 mg/l
Phenol index (calculated as phenol)	0.1 mg/l	10 mg/l

Emission standards for waste water from urea and melamine production (BGBl. 1996/669)		
General parameters	Discharge to running water	Discharge to public sewage system
Temperature	30 °C	35 °C
Toxicity to fish G _F	4	no impairment of the public waste water treatment plant
Filter out matter	30 mg/l	150 mg/l
PH-value	6.5 – 8.5	6.5 – 9.5
Inorganic parameters		
Ammonium (calculated as N)	0.5 kg/t	0.5 kg/t
Nitrate (calculated as N)	0.5 kg/t	0.5 kg/t
Nitrite (calculated as N)	0.02 kg/t	0.02 kg/t
Organic parameters		
COD (calculated as O ₂)	0.5 kg/t	-

C3: Wastes [Austria UBA, 2000 #97]

Two Austrian ordinances have been enacted to transpose the council directive 94/67/EC concerning the combustion of hazardous waste. All emission limits relate to dry exhaust gas and an oxygen content of 11 %.

Emission limits for the co-incineration of hazardous wastes in combustion plants		
Component	Half hourly mean value	Day mean value
Dust-like emissions	10 mg/m ³	10 mg/m ³
Gaseous and vaporous organic substances (calculated as total fixed organic carbon)	10 mg/m ³	10 mg/m ³
Hydrogen chloride	10 mg/m ³	10 mg/m ³
Hydrogen fluoride	0.7 mg/m ³	0.5 mg/m ³
sulphur dioxide (calculated as SO ₂)	50 mg/m ³	50 mg/m ³
Nitrogen oxides (NO + NO ₂)(as NO ₂)	400 mg/m ³	200 mg/m ³
V _{waste gas} ≥ 5 000 m ³ /h	300 mg/m ³	200 mg/m ³
V _{waste gas} ≥ 10 000 m ³ /h: new plants	100 mg/m ³	70 mg/m ³
V _{waste gas} ≥ 10 000 m ³ /h: existing plants	150 mg/m ³	150 mg/m ³
carbon monoxide	100 mg/m ³	50 mg/m ³
Ammonia	10 mg/m ³	5 mg/m ³
Cadmium & thallium and their compounds (as Cd and Tl)	0.05 mg/m ³ ⁽¹⁾	
Mercury and its compounds (calculated as Hg)	0.05 mg/m ³ ⁽¹⁾	
The sum of antimony, arsenic, lead, chromium, cobalt, copper, manganese, nickel, vanadium, tin and their compounds (calculated as Σ Sb, As, Pb, Cr, Co, Cu, Mn, Ni, V, Sn)	0.5 mg/m ³ ⁽¹⁾	
PCDD/F's (calculated as 2,3,7,8 TCDD toxic equivalent)	0.1 ng/m ³ ⁽²⁾	
1. Averaging period between 0.5 and 8 hours		
2. Averaging period between 6 and 8 hours		

D. The Netherlands

Dutch environmental policy, legislation and regulation [Leendertsee, 2001 #158]

D1. Policy

The Dutch Environmental Policy is laid down in the National Environmental Policy Plan (NEPP) and the Memorandum on Water Management (MWM), which are updated regularly. The NEPP and the MWM set the environmental targets for the medium long term and outline the policy to achieve these targets.

D2. Framework legislation

The Netherlands has two main framework environmental acts, being the 'Environmental Management Act' and the 'Surface Water Pollution Act'. These acts together provide the framework for environmental permitting and allow for setting conditions to the permit. The acts comply with the requirements of the IPPC Directive and integrated permitting is guaranteed by a co-ordinated licensing procedure from the competent authorities. Both framework acts govern a number of Decrees and Regulations that provide requirements with regard to potentially polluting activities.

D3. Safety legislation

Safety is a very important issue for the Large Volume Organic Chemical Industry. The main legislation with regard to safety is the Seveso II Directive. The Council Directive 96/82/EC of 9 December 1996 on the control of major-accident hazards involving dangerous substances (the Seveso II Directive) is aimed at the prevention of major accidents which involve dangerous substances, and the limitation of their consequences for man and the environment, with a view to ensuring high levels of protection throughout the Community in a consistent and effective manner.

The directive is mainly implemented in the Netherlands by means of the 'Besluit risico's zware ongevallen 1999' (Brzo 1999 for short) of 27 May 1999. The Seveso-II directive obliges operators of fixed hazardous establishments to supply the competent authorities with information on internal and external safety matters. Topics like process safety management systems, land use planning, safety measures, safety assessment studies (Safety Report), domino effects and disaster planning are important information requirements. Furthermore the competent authorities have obligations towards the reviewing and handling of safety reports and physical inspection of hazardous installations.

The report on Information Requirements BRZO 1999 (CPR 20) is intended to explain the rules as laid down in the BRZO 1999 and in detailed rules, and to indicate how various aspects should be implemented. CPR 20 has been drawn up to assist companies in fulfilling the requirements laid down in the BRZO 1999. CPR 20 is intended both for companies and for the government authorities involved. It should be noted that for the government authorities, besides CPR 20, there is also an administrative guideline Seveso II (HUBO). HUBO relates specifically to the approach by government authorities.

The BRZO 1999 is based on various acts. With the single-contact principle the information concerning safe working practice (the Labour Safety Report or in Dutch 'AVR'), external safety and environmental risks (the External Safety Report or in Dutch 'EVR') and/or the company fire brigade provision (report relating to the company fire brigade) have been integrated into a single reporting obligation, and submission of the information takes place via a single contact point.

D4. Decrees and regulations

Netherlands emission regulations (NeR)

The Netherlands emission regulations apply to process emissions to air and provide guidelines for the conditions in environmental permits for emissions to air. The NeR follows the same basic concept as the German TA-Luft, except that the classification of some substances has been adjusted in the light of recent toxicological findings. In addition, the emission standards for some classes of substances have been adjusted in line with current knowledge with regard to best available techniques. On the other hand, since its publication in May 1992, the general emission standards have not been reviewed.

In the NeR, concentration standards for different substances are given, which constitute upper limits for distinct point sources, depending on mass flow. The 'special regulations' comprise measures to limit emissions from incidental discharges or diffuse sources. Furthermore, in the 'special regulations' rules departing from the 'general emission standards' for certain industries or specific installations are given. The NeR classification is given as an example in the Annex on page 397 of this BREF. The emissions standards in the NeR are not legally binding and the NeR does not replace existing binding agreements. However, if the licensing authority wishes to depart from the NeR, the reasons for doing so must be stated explicitly in the preamble to the licence.

For the large volume organic chemical industry, only one 'Special Regulation' is made: 'NeR 3.5/29.3a Production of acrylonitrile'. Where no special provisions are explicitly stated in a special regulation, the general rules of the NeR apply.

Decree on emissions standards for combustion plants (BEES)

The Dutch Decree on emissions from combustion plants (BEES) is a legally binding decree in which emission standards for combustion plants are given. The decree applies to emissions of NO_x, SO₂ and particulate matter of specified categories of combustion plants. The European LCP-directive (Council Directive 88/609/EEC 24 November 1988 on the limitation of emission of certain pollutants into the air from large combustion plants) is implemented in the Netherlands through the BEES. The date of environmental legislation, the type of combustion plant and the type of fuel are decisive factors for the emission standards to be applied. In the large volume organic chemical industry, BEES applies to nearly all combustion plants and process furnaces.

KWS 2000/VOS

In view of the ozone/smog problem and the resulting necessity to reduce the emission of volatile organic compounds (VOC), the project 'KWS 2000' ('Hydrocarbons 2000') was initiated in the Netherlands in 1986. The project KWS 2000 focuses exclusively on the reduction of VOC emissions from industry, small and medium enterprises and households. No attention is paid to the smog-enhancing component NO_x, because this component is already dealt with in the acidification policy. Within the project, source-oriented measures and overall reduction targets for distinct branches are formulated. These measures can be distinguished in three types: certain measures, conditional measures and uncertain measures. The implementation of measures is laid down in the environmental permit of an enterprise and/or through mutual agreements between industrial sectors and authorities. The project has the possibility to stimulate new developments with grants. For the large volume organic chemical industry, specific measures have been formulated for emissions from point sources of VOC, for storage tanks and for fugitive emissions. The project was finalised successfully by the end of 2000 and the Dutch authorities are currently drawing up a new programme ('VOS') with renewed goals, priorities and tools.

D5. Voluntary agreements

Voluntary agreements or covenants (in Dutch: 'Convenanten') are declarations of intent on the implementation of environmental policy for certain industrial sectors. The declarations of intent are agreements between the authorities and the industry. The participation in a covenant gives the advantage for both competent authorities and companies of a more transparent, coherent and

predictable path of environmental improvement and investments. The covenants are nowadays applied in three fields:

- General environmental performance on 'traditional' pollutants.
- Energy efficiency
- CO₂ reduction

General environmental performance on 'traditional' pollutants

In the declaration of intent of this voluntary agreement, the authorities have drawn up an Integral Environmental Target Plan (IETP), based on the National Environmental Policy Plan (NEPP), the Memorandum on Water Management, the North Sea Action Plan, The Rhine Action Programme, the Memorandum on Energy Conservation and other official plans at the time of signature.

The Integral Environmental Target Plan is concerned with environmental pollution of the 'traditional' pollutants (SO_x, NO_x, VOC, heavy metals, PAH, etc.) caused by the relevant industrial sector. The IETP has been drawn up for the years 1994/1995, 2000 and 2010.

Apart from the reduction in emissions into the air, water and soil, the IETP also incorporates policy with regard to energy conservation, water conservation, soil clean up, hazard risk, odour nuisance, noise and internal management systems. However, especially for energy conservation and CO₂ reduction, two other covenants have been agreed upon.

For the 'chemical industry', a declaration of intent was signed on 2nd April 1993. A significant factor is the understanding that in view of the wide range of disparate companies in the chemical industry, the contribution of each individual company to the implementation of the IETP in the industry may vary. The responsibility of individual companies to contribute to the implementation of the IETP in the industry requires that these companies take an active stance. The contribution of a company will be defined in Company Environmental Plans ('BMP's'), which are drawn up by each company. These BMP's are renewed every four years and must be agreed upon by the licensing authority.

Energy efficiency: Long Term Agreements on Energy Efficiency

In the Netherlands, 'Long Term Agreements on Energy Efficiency (MJA's)' have been made between the Ministry of Economic Affairs and representative organisations of many industrial sectors. The most important aspect of the MJA's is the target value for improvement of energy efficiency in the relevant industrial sector within a certain time frame. For the elaboration of the MJA's, bilateral agreements are made between the individual companies and the facilitating agency, which is NOVEM. For the chemical industry, an MJA was signed on 24 November 1993 and the agreed improvement of energy efficiency was 20 % over the period 1989-2000. The target has been achieved by the sector and a second round of MJA's is now in preparation, although most of the LVOC companies will probably join the 'Benchmarking' covenant (see next item).

CO₂ reduction: Benchmarking covenant

In the light of the Kyoto agreements, the Netherlands has to reduce the emission of CO₂. Improvement of the energy efficiency is one of the most important measures to reduce the CO₂ emissions. The Benchmarking covenant is an agreement between the Dutch authorities and the Dutch energy intensive industry. The industry agrees to belong to the world top in energy efficiency and the authorities will then refrain from impairing additional CO₂ reduction measures. The agreement is open to all companies with an energy use of 0.5 PJ per year or more.

The principle agreement was signed on 6 July 1999 between the industrial organisations and the authorities. Now that the principle agreement has been signed, the agreement is open to individual companies to sign in on the covenant. For those companies that do not want to join or that have an energy use of < 0.5 PJ per year, the 'traditional' MJA route (see above) will be followed.

E. Sweden

1. There is no general guideline for the setting of limit values. The technical officer in an environment authority must have a good command of the technologies used and available or access to such knowledge, as well as the impact on the environment and what can be achieved to counter such impact. These officers give statements to the court on what is acceptable influence on the environment and how this influence should be controlled.

The actual permit is written by an Environment Court in the case of major process industries. The ruling is based on the information and advice given from national, regional and local authorities as well as the operator itself.

2. The Swedish legal situation is laid down in the Environmental Code. Each facility is tried on its own and the requirements with regard to water and gas treatment are set individually with a view to the recipient situation etc. In the Code this is formulated as a series of principles:

- The burden of proof principle - the operators must demonstrate that their operations are undertaken in an environmentally acceptable manner. The burden of proof is always on the operator.
- The knowledge requirement - persons who pursue an activity must possess the knowledge that is necessary in view of the nature and scope of the activity. The purpose of the provision is to ensure that operators acquire the relevant expertise before starting operations, thus preventing damage and detriment.
- The precautionary principle - the mere risk of damage or detriment involves an obligation to take the necessary measures to combat or prevent adverse health and environmental effects.
- Best possible technology - applies to the technology used for the operation itself and for the construction, operation and decommissioning of the plant. An essential condition is that it must be feasible in industrial and economic terms in the line of business concerned.
- The polluter pays principle - the operation must pay for the preventative or remedial measures that are required.
- The resource management and ecocycle principles - an operation must be undertaken in such a way as to ensure efficient use of raw materials and energy and minimisation of consumption and waste.
- The reasonableness principle - all the rules are to be applied under consideration of benefits and costs. It is the operator who, in accordance with the burden of proof principle, must demonstrate that the cost of a protective measure is not justified from an environmental point of view or that it represents an unreasonable burden.

Hence in the permitting process, the operator will have to demonstrate what treatment techniques are valid, and suggest one or several of them to treat wastewater and waste gas (etc.) as required. Chosen technologies and conditions set will depend on BAT to the extent that it is available for the chemical industry, technology proven in similar production elsewhere, etc. A range of solutions and conditions are possible depending on location, process technology, etc.

ANNEX II: LEAKING LOSSES

[InfoMil, 2000 #83]

Leaking losses are often hard to determine since there are many potential sources and they are very dependent on how well the installation is maintained. Some important causes of leaking losses are: ill-fitting internal or external sealing elements; installation- or construction faults; wear and tear; equipment failure; pollution of the sealing element; and incorrect process conditions. Leaking losses are generally higher from dynamic equipment (compared with static equipment) and from older equipment. The main potential sources, and possible reduction techniques, are considered below:

Sources

Flanges: Individual flanges generally do not have very large leaking losses but, since plants utilise so many flanges, they can make a major contribution to the overall leaking losses. Preventive measures, among which regular maintenance (e.g. controlled tightening of the flange), are very important. The regular control and replacement of the gaskets is also necessary, especially for those gaskets exposed to temperature fluctuations or vibrations as they age rapidly. When a removable connection is not necessary, flanges can be replaced by stainless steel welded piping. When welding is not possible, fibre-based gaskets can be replaced with gaskets made of other materials (e.g. PTFE, graphite).

Valves: Valves, and especially control valves, are an important source of leaking losses, and may account for 75 % of the leaking losses in a plant. The chance of leakage depends on the kind of valve. Diaphragm valves, ball valves and bellows-sealed valves have less leaking losses than conventional valves. The packing has an important influence on valve leaking losses, especially in disc valves. Fibre-based gaskets can be replaced with gaskets made of other materials (e.g. PTFE, graphite).

Safety valves: Safety valves can be responsible for 10 % of a plant's leaking losses. Losses are higher where safety valves are exposed to pressure fluctuations, and when a safety valve has activated. Therefore, safety valves should be checked after an emergency situation. Leaking losses via safety valves may be reduced by the installation of rupture discs prior to the safety valve to damp small pressure fluctuations. However, these fluctuations may pollute the valve, making complete closure impossible. An additional measure is to connect safety valves to a central flare system or another type of dedicated collection system (e.g. vapour recovery/destruction unit).

Pumps: Pumps have high leaking losses, compared to other equipment, but due to their relatively low numbers in a plant the overall contribution of pumps is relatively small. As there are few pumps it is relatively simple to find and repair leaking pumps. Pump leaking losses occur mainly at the exit where the rotating shaft leaves the housing. In general, the gland packing in positive-displacement pumps leaks more than the mechanical seals of centrifugal pumps, and, where possible, gland packing should be replaced by mechanical seals. Even better results are obtained with a dual mechanical seal (a barrier liquid between the two mechanical seals that almost completely prevents leaking losses). Contamination of the barrier liquid will reduce the effect of the seal, so the liquid has to be checked regularly for contamination. Leaking losses are also reduced by replacing conventional pumps with electromagnetic pumps or closed coupled pumps. These pumps have a completely closed construction that almost completely prevents leaking losses. But electromagnetic pumps have only limited power and are very sensitive to particles in the medium and closed coupled pumps are not to be used for toxic materials due to potentially severe leakage during failures.

Compressors: Compressors often have high leaking losses and regular control and maintenance is indispensable. Reduction of leaking losses can be obtained by replacing gland packings with mechanical seals. Alternatively, leaking losses can be removed by suction; and either returned to the system or flared.

Open-ended lines: Emissions from open-ended lines can be controlled by properly installing a cap, plug or second valve at the open end. If a second valve is installed, the upstream valve should always be closed first after use of the valves to prevent the trapping of fluids between the valves.

Sampling points: Emissions from sampling connections can be reduced by using a closed-loop sampling system or by collecting the purged process fluid and transferring it to a control device or back to the process.

Determining leaking losses

A structural reduction of leaking losses is only possible when insight on the leaking losses is gained. There are various methods to determine the leaking losses. The simplest way to estimate the leaking losses is by multiplying the number of each type of equipment by an emission factor for that type of equipment. This method can be applied to obtain a general estimation of the emissions without measurements. Emission factors are not intended as an accurate measure of a single piece of equipment, and do not reflect the site-specific conditions of process units.

Many companies determine their leaking losses by calculations or estimations based on measurements, but it is hard to measure all possible sources in a large plant (possibly tens of thousands) and not all sources are accessible. In most cases, a representative sampling of sources will suffice to estimate or calculate the leaking losses of the plant. The number of samples depends on the kind of chemicals in the plant and the kind of equipment (the sources). The table below provides a possible sampling strategy (the figures indicate the percentage of sources that should be measured to obtain insight into the leaking losses). The subdivision of the chemicals is based on their classification in the Netherlands emission Regulations (NeR).

Possible source	NeR class		
	Carcinogens without threshold values (C.1-C.2-C.3)	Organic substances	
		O1	O2-O3
Valves	100 %	50 %	20 %
Pumps	100 %	100 %	100 %
Mixing gear	100 %	100 %	100 %
Compressors	100 %	100 %	100 %
Safety valves	100 %	100 %	100 %
Flanges	100 %	50 %	5 %
Open-end lines	100 %	80 %	80 %
Sampling points	100 %	50 %	50 %

Possible sampling strategy to determine reference measurements

Various methods can be used to make an estimation or calculation of the total leaking losses, viz.

1. **Screening range approach:** This approach was formerly known as the 'leak - no leak' approach, and distinguishes between leaking sources (emission >10000 ppm) and non-leaking sources (emission <10000 ppm). Different emission factors apply to leaking / non-leaking sources, and to the chemical nature (gas, light liquid or heavy liquid). The emission of a certain kind of equipment is determined by multiplying the number of each type of equipment by its emission factor.
2. **Stratified EPA-approach:** This approach refines the screening range approach. The emission factors are refined by dividing the measurements into categories (e.g. <1000 ppm, 1000 - 10000 ppm, and >10000 ppm).
3. **EPA correlation approach:** This approach offers an additional refinement to estimating emissions from equipment leaks by providing an equation to predict mass emission rate as a function of screening value for a particular equipment type.
4. **Unit-specific correlation approach:** This is similar to the EPA correlation approach, but the unit-specific correlation screening value must be collected from process equipment.

In the Netherlands, the stratified EPA-approach is widely used to obtain an indication of the overall leaking losses. A piece of equipment emitting a substance of NeR class C.1, C.2 or C.3, is considered to be leaking when the measured value exceeds 500 ppm, and the aim is to minimise emissions of these compounds. Equipment emitting other substances is considered to be leaking when the measured value is more than 1000 ppm. Once leaking losses have been located and quantified, it is possible to reduce losses using a plant-specific control programme. This control programme consists of organisational and technical measures, divided into three phases:

1. 'Reactive' maintenance with control measurements: Based on the measurements and calculations, the 'leaking' equipment must be repaired. In addition to that, a strategy for additional (control) measurements is indispensable. These additional measurements should cover repaired sources; 'non-leaking' sources; and equipment that has not been measured before. Using this strategy, insight on the emission reduction is obtained, and new leaks are registered and repaired. In the long run, all reachable sources will be measured.
2. 'Preventive' maintenance with control measurements: In this phase, special attention is paid during regular maintenance to leaking losses. At the start, phase 1 and 2 are 'mixed': all reachable sources have to be measured and, if necessary, repaired. Later on in phase 2, sampling of sources will do. It is advised though, to sample at least the kind of sources with a high 'leaking percentage' during the reference measurements. The company management should initiate this 'preventive' maintenance and in most cases it might be practicable to appoint a co-ordinator. If leaking losses increase again, this co-ordinator can adjust the maintenance strategy. Furthermore, the management should make time and resources available to make this maintenance method possible.
3. Extensive 'preventive' measures with control measurements: The third phase is mainly similar to the second. Control measurements assure relatively low leaking losses: otherwise, the co-ordinator can adjust the maintenance strategy. In this third phase though, technical improvements make a further reduction of the leaking losses possible. For example, more suitable equipment can be bought when the old equipment is replaced, or company experiences can be used to design new installations. In this phase, the commitment and awareness of all employees is important. The purchase of different equipment or other technical improvements might be more expensive. Otherwise, these technical improvements will reduce the costs of maintenance and repairing.

ANNEX III: FLARE SYSTEMS

[InfoMil, 2000 #83]

Flare systems are essentially safety systems, used for the safe release of combustible gases and vapours. The release can arise for a number of reasons; for example: an emergency shutdown, relief of excess pressure caused by process upset conditions (open pressure relief valve), venting from equipment (start-up, shutdown), or the quality of the gaseous products does not meet the specifications (process failure). Flares can also be an effective technique for the treatment of small and/or discontinuous vents of VOCs.

The potential sources (pressure relief valves, safety valves and process vents) are connected to a collection system. For safety reasons, no mechanical valves or shutters are allowed in the system, so the collection system is in open connection to the flare tip. A continuous stream of purge gas (nitrogen or fuel) is required to keep the flare gas system on overpressure in order to prevent ingress of air, which may create an explosive mixture. The collection system is also equipped with a knockout drum, to separate any liquid from the vapours and gases.

The flare system must be able to handle a large range of flow rates and variable composition of feeds. In regular operation only leaking gases enter the flare system, but the system must also be able to handle the peak load occurring during emergencies.

The flare system consists of one (or more) burners, a pilot-ignition system, and, in some cases, steam nozzles. The flare gas ignition system eliminates the need for continuous flaring. The design of burners must create good mixing of the combustibles with air to ensure complete combustion and lower formation of soot and other products of incomplete combustion (VOC, CO, traces of original components).

There are basically two types of flares: elevated flares and ground flares. Generally elevated flares are designed for large capacities (hundreds of tonnes per hour). The flare height varies between 20 m and 120 m, depending on the heat radiation on the ground and the calculated emission concentration from an un-flared gas release. The heat radiation generally limits the capacity of the flare. The main advantage of the elevated flare is the safe and quick handling of large amounts of combustible gases. Important disadvantages are the light and noise nuisance in the surroundings of the plant.

Ground flares are designed for much smaller capacities (tens of tonnes per hour) than elevated flares, and generally handle the 'base load' of combustible gases that is generated by point sources that are connected to the flare system during normal operation. This mainly includes leaking safety valves and sometimes also the starting-up and shutting down of sections of the plant. The large diameter of the ground flare allows for more burners. Thus, the ground flare can be adjusted to varying amounts of flare gas by adjusting the number of operational burners. This improves the combustion conditions and results in higher combustion efficiency. Generally, the most important advantage of ground flares compared to elevated flares is the reduced flame visibility. The potential escape of gases in the case of malfunctioning ground flares, and the resulting health and safety risks, necessitates more stringent monitoring and control. For this reason toxic gases are never flared in ground flares.

Many LVOC production sites operate an integrated flare system consisting of a ground flare (with an optimal burner design for gas flows during regular operation), and an elevated flare (for high flow rates of flare gas during emergencies and process upsets). Some LVOC sites may not operate ground flares if they use the base load of combustible gases as a fuel or operate vapour recovery/destruction systems.

Environmental aspects

The environmental impact of flares depends, to a large extent, on the combustion efficiency. Under optimum conditions, a combustion efficiency of >99 % can be achieved in both elevated

and ground flares and emissions will consist of combustion gases (mainly CO₂, water and thermal NO_x) and, depending on the composition of the feed gases, SO₂ and 'fuel NO_x'.

However, conditions are not always optimal. Well-known problems are poor mixing of fuel and combustion air, high wind speeds, low calorific value of the feed gases and a low flow rate of feed gases. Under such circumstances the combustion efficiency may drop significantly, and products of incomplete combustion may be emitted (soot, CO, VOC and the flared component).

Medium	Potential effect/emission from flares
Air	<ul style="list-style-type: none"> • Combustion related emissions (CO₂, H₂O, NO_x, C_xH_y, CO, soot) • 'Fuel' related emissions (e.g. SO₂, fuel-NO_x, trace amounts of the 'fuel')
Water	<ul style="list-style-type: none"> • Watery condensates from the knockout drum
Waste	<ul style="list-style-type: none"> • (By)product condensates from the knockout drum
Other	<ul style="list-style-type: none"> • Light nuisance from elevated flares • Noise nuisance from elevated flares • Odour nuisance caused by poor combustion in the flare (mainly ground flares)

It is useful to make a distinction between normal operation and operation during emergencies. Companies that have an integrated flare system tend to use the elevated flare only for emergencies, and in such cases large quantities of undiluted process gases are flared. The combustion efficiency of elevated flares can be very high (> 99 %), but important parameters are the mixing of fuel and air, the wind speed and the flow rate of the gas. Especially when flaring 'heavier' hydrocarbons, steam injection is necessary to achieve complete combustion. The steam injection serves several purposes. Firstly, it improves the mixing of fuel and air (and thus combustion efficiency) by creating turbulence. Secondly, it protects the flare tip by keeping the flame away from the metal. Thirdly, the steam reduces soot emissions as it reacts with solid carbon particles ('soot') to form CO, which is then further oxidised to CO₂. And lastly, the steam injection probably also reduces thermal NO_x formation. When hydrogen or very 'light' hydrocarbons are flared, steam injection is usually not applied as air-fuel mixing is often good and soot formation is unlikely.

The combustion conditions in elevated flares are more difficult to control compared to ground flares. For rich mixtures with a sufficient flow the combustion efficiency will generally be high. However, for leaner mixtures with a low flow, the efficiency of the elevated flare will drop significantly. Such conditions occur during regular plant operation. The visual nuisance and noise from elevated flares should not be underestimated, and so elevated flares should be used predominantly during emergencies. During regular operation, there are more efficient and flexible tools to re-use or destroy the base load of unwanted gases (e.g. re-use as fuel, destruction in ground flare or vapour destruction unit).

Many companies operate a ground flare that handles the 'base load' of flare gases, even though the 'base load' is rarely a well-defined continuous flow. It is the result of all the individual sources connected to the flare system and includes gases from leaking equipment, gases from venting/ flushing of equipment and importantly, the inert gas used to purge the flare gas system. If the amount of purge gas is relatively high, the calorific value of the flare gas drops to critical values. Both the irregularity and the low calorific value of the gases may cause the ground flare to operate at lower efficiencies (sometimes down to 70 %). It is a misunderstanding that ground flares always have a better performance than elevated flares. In fact, ground flares may operate poorly due to the poor quality of fuel and the overall longer operation time. The emissions of non-combusted hydrocarbons may give rise to odour problems and even create health and safety problems.

Issue	Elevated flares	Ground flares
Capacity	Up to hundreds of tonnes per hour	Up to tens of tonnes per hour
Advantages	Quick and safe release of large amounts of gases. Low emission concentrations in case of malfunction of the flare.	Less flame visibility. Less noise. Better combustion (less soot). More reliable ignition (less affected by wind). More flexible to gas flow variations in the low range
Efficiency for VOC	>98 % under optimal conditions. 0 - 98 % under sub-optimal conditions.	>99 % under optimal conditions. 0 - 99 % under sub-optimal conditions.
Disadvantages	Light nuisance. Noise nuisance. Difficulties in handling low flows.	Limited capacity. Increased safety risks when malfunctioning. Potentially reduced efficiency due to often poor fuel quality.

Comparison of elevated and ground flares

Available techniques for emission prevention

The first priority is to avoid the generation of flare gases. This can be done by plant design and process control (e.g. prevention of failures, fine-tuning of the process, prevention of leaking). The extent to which this can be achieved differs from plant to plant and there is no general rule. The second priority is to re-use the 'base load' of gases in 'flare gas recovery systems' (although this is not possible in the case of emergencies when prompt and safe disposal is necessary). If the quality of the flare gases is good or not critical to the process, the gases can be recycled into the process. If the quality of the flare gas is less or critical to the process, the gases might be used in other processes or used as a fuel in the fuel system of the plant. These re-use options are usually also very attractive from an economic point of view.

For toxic gases the use of a dedicated incinerator might be the best option if re-use is not possible. The incinerator secures the proper combustion and allows for heat recovery and additional treatment if necessary.

Any remaining 'base load' flare gases must be sent to the flare (usually a ground flare) and combusted with the highest possible efficiency. This is assisted by a feed gas of high calorific value and a good mixing of air / fuel. Ironically, the quality of the flare gases is usually worst when prevention and re-use options are implemented.

For a stable combustion, the calorific value of the flare gas should be above 8300 KJ/m³. A low calorific value is usually caused by the relative high percentage of purge gas (usually N₂). There are generally two options to deal with this. The easiest method is to purge (partly) with a combustible gas (e.g. natural gas). The second method is to reduce the amount of purge gas. However, this can only be done if measures are taken to maintain the necessary slight overpressure in the flare system. Possible measures are water seals, fluid seals and molecular seals.

ANNEX IV: INCINERATORS

[InfoMil, 2000 #83]

Incineration, or thermal oxidation, is the process of oxidising combustible materials by raising the temperature of the material above its auto-ignition point in the presence of oxygen, and maintaining it at high temperature for sufficient time to complete combustion. Residence time, temperature, turbulence (for mixing) and the availability of oxygen all affect the rate and efficiency of the combustion process.

Incinerators are primarily used to reduce emissions of volatile organic compounds (VOC) and/or toxic compounds, and are a proven technology with efficiencies of more than 99 %. In some cases, incinerators are used to reduce odour or emissions of sooty particulate matter. They may also be used for controlling organic halogen or sulphur compounds, but the formation of highly corrosive acids (e.g. hydrogen chloride, hydrogen fluoride, sulphur dioxide) requires extra precautions and treatment of the gases. These acid gases can be removed by scrubbing with a caustic scrubbing liquid or water, but this results in the generation of waste water requiring treatment. In some cases, valuable components (e.g. HCl) can be recovered from the waste gases.

Potential emissions to air, water and waste from incinerators	
Medium	Potential effect/emission
Air	<ul style="list-style-type: none"> • Combustion related emissions (CO₂, H₂O, NO_x, C_xH_y, CO, soot) • 'Fuel' related emissions (e.g. HCl, HF, HBr, SO₂, fuel-NO_x, metals, possibly dioxins and trace amounts of the 'fuel' component)
Water	<ul style="list-style-type: none"> • Only if wet waste gas scrubbing is applied, waste water emissions are generated. Potential discharges depend on the composition of the combusted gases.
Waste	<ul style="list-style-type: none"> • If the 'fuel' has an ash-content (e.g. metals, salts), a waste is generated • If dry waste gas cleaning or chemical waste gas scrubbing is applied, waste is generated
Other	<ul style="list-style-type: none"> • Energy is consumed to keep the combustion process running

A distinction is made between thermal incinerators and catalytic incinerators. The heart of a thermal incinerator is a nozzle-stabilised flame maintained by a combination of auxiliary fuel, waste gas compounds and supplemental air when necessary. Upon passing through the flame, the waste gas is heated from its inlet temperature to its ignition temperature. The ignition temperature varies for different compounds and is usually determined empirically. The incineration typically takes place at a temperature of 700 - 1000 °C. The shorter the residence time, the higher the reactor temperature must be.

Catalytic incinerators operate very similarly to thermal incinerators, with the main difference that the gas, after passing through the flame area, passes through a catalyst bed. The catalyst has the effect of increasing the oxidation reaction rate, enabling conversion at lower reaction temperatures than in thermal incinerator units (300 - 500 °C). Catalysts typically used for VOC incineration include platinum and palladium. Other formulations include metal oxides, which are used for gas streams containing chlorinated compounds.

Both thermal and catalytic incinerators have certain advantages and disadvantages. Thermal incinerators are often the best choice when high efficiencies are needed and the waste gas is above 20 % of the Lower Explosion Limit (LEL). On the other hand, thermal incinerator operating costs are relatively high due to supplemental fuel costs. Thermal incinerators are generally not cost-effective for low-concentration, high-flow organic vapour streams. Furthermore, thermal incinerators are not well suited to streams with highly variable flow because of the reduced residence time and poor mixing during increased flow conditions, which decreases the completeness of combustion. This causes the combustion chamber temperature to fall, thus decreasing the destruction efficiency.

Catalytic incinerators require less fuel and operate at lower temperatures (300 - 500 °C). Fire hazards and flashback problems are reduced and less volume/size is required. Catalytic incinerators also have disadvantages: the initial costs are relatively high, catalyst poisoning is possible, dust often must be removed first and spent catalyst that cannot be regenerated may need to be disposed.

The waste gas leaving the incinerator has a relatively high temperature (300 - 1000 °C), making energy recovery possible. Both thermal and catalytic incinerators are available in a recuperative variant and in a regenerative variant. Recuperative incinerators have heat exchangers placed in the hot outlet gas streams. The 'cold' untreated waste gas is preheated with the hot flue gases leaving the incinerator. Recuperative incinerators recover about 70 % of the waste heat from the exhaust gases, which means a significant energy saving.

Regenerative incinerators use a high-density media such as refractory-packed beds in alternating cycles of heating and cooling. The packed bed still hot from a previous cycle preheats the incoming waste gas stream. The hot flue gases from the combustion chamber are directed to another packed bed. This bed absorbs the heat of the flue gases. When the packed bed that preheats the incoming waste gases has cooled down too much, the flow of gases is reversed and the cycle starts all over again.

A different variant consists of a ceramic packed bed, in the middle of which thermal oxidation takes place. Valves regularly reverse intake and outlet, so the flow direction changes and the 'hot zone' remains in the middle of the bed. A regenerative thermal incinerator recovers 85 - 95 % over the energy and has a better destruction efficiency than a recuperative incinerator, due to better heat resistance. Furthermore, problems with chlorinated compounds are less and generally lower NO_x emissions than thermal oxidation (except when operating temperatures are above approx. 760 °C). The initial costs are high, though, and the installation is complex and expensive. The installation is large and the moving parts demand high maintenance.

A regenerative catalytic incinerator operates in the same manner as a regenerative thermal incinerator; however, it uses a catalyst material (a precious metal, e.g. platinum or palladium) rather than ceramic material in the packed bed. Compared to a regenerative thermal incinerator, a regenerative catalytic incinerator requires less fuel and has lower NO_x emissions. Furthermore, the catalyst also destroys CO in the waste gas stream. Besides the same disadvantages as a regenerative thermal incinerator, catalyst poisoning is possible, particulate matter often has to be removed first (to prevent poisoning of the catalyst). Spent catalyst that cannot be regenerated may need to be disposed.

Special attention should be paid to the potential formation of polychlorinated dibenzodioxins and -furans (PCDD/PCDF) in incinerators that handle chlorinated organic compounds. Especially de-novo synthesis may occur during slow cooling of waste gases that still contain organic compounds and chlorine compounds. In order to avoid the generation of dioxins, the conditions should be chosen such that de-novo synthesis is suppressed. Some rules of thumb are a residence time of >1.5 seconds at a temperature of >850 °C and an oxygen content of >3 % in the combustion chamber. Furthermore, a rapid cooling ('quenching') of the waste gases after the incinerator is essential. By these means it is normally possible to keep the emissions of dioxins and furans at a level of <0.1 ng I-TEQ/Nm³.

ANNEX V: STRATEGIES FOR INDUSTRIAL WASTE WATER TREATMENT

[InfoMil, 2000 #83]

The production of large volume organic chemicals is often concentrated on highly integrated sites with strong links to downstream plants. The waste waters from such sites pose particular challenges and this Annex provides a possible framework of technical and management techniques for treating the waste water. Reference is made to the waste water treatment strategies adopted by two highly integrated sites for the production of LVOC. The site 'fingerprints' are presented below.

Fingerprints of two highly integrated sites for the production of large volume organic chemicals				
Characterisation	Company A		Company B	
Production facilities	Ethylene and several grades polyethylene. Propylene and several grades polypropylene. Butadiene. Ammonia and nitrate. Fertilisers. Caprolactam and other organic nitrogen compounds.		Ethylene and several grades polyethylene. Ethylene oxide, Ethylene glycol, polyglycols. Benzene. Butadiene. Styrene and polystyrene. Ethylene amines.	
Relative production (kt/yr)				
1970 (absolute/relative)	5200 (water relevant)	100	1500 (total site)	100
1995 (absolute/relative)	8300 (water relevant)	160	5000 (total site)	333
Discharge to surface water (in PE)*				
1970 (absolute/relative)	750000	100	950000	100
1995 (absolute/relative)	20000	3	20000	2
<ul style="list-style-type: none"> • PE = pollution equivalent: 1 PE is equivalent to the production of oxygen consuming pollutants by one inhabitant. The total amount of pollution is calculated using the formula: $PE = (Qd/136) * (COD + 4.57 N\text{-Kjeldahl})$. Where: Qd = total amount of waste water (m³/day), COD = chemical oxygen demand (in mg O₂/l) and N-Kjeldahl = the concentration of organic nitrogen compounds (in mg/l). • Note: There are differences in water use by the two companies. Company A produces monomers by means other than the cracking of naphtha, and these are usually use water-based processes. 				

In the early-1970s the production facilities of both companies generated waste water with a Population Equivalent in the order of 1000000. However, the two companies developed their own distinct strategies for waste water abatement. Both strategies resulted in massive reductions of emissions to surface water (see figure below) but using a different combination of techniques. Company A implemented process integrated measures and built a large waste water treatment plant. Company B implemented process-integrated measures, side-stream treatment facilities and a relatively small, biological waste water treatment plant. The differences in approach can be explained through by some local circumstances that are tabulated below:

Relevant aspects with regard to the waste water treatment selection		
Aspect	Company A	Company B
Geographical location	River Meuse	Scheldt estuary
Year of foundation	± 1930	1969
Sewer system	Gravity, combined system	Separated system (process sewer, no contaminated sewer)
Other aspects	Low responsible care on working floor. At two locations downstream from the site intake of surface water for preparation of drinking water.	Low responsible care on working floor. Bad experiences with biological waste water treatment systems.

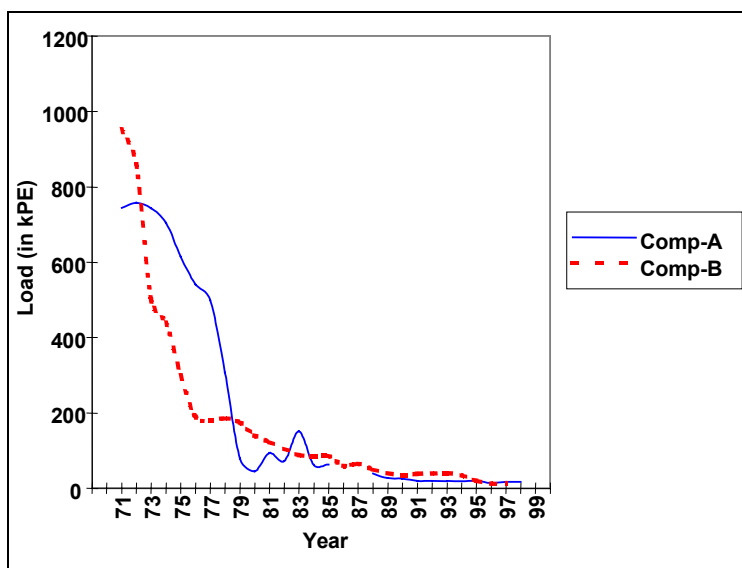

Average daily load of organic pollutants (in kPE)

Company A. There was much external pressure on Company A to reduce the pollutant loads discharged to the river as it was causing significantly elevated levels of nitrates in the River Meuse (which affected the downstream abstraction for drinking water plants). The availability of both nitrates and readily biodegradable compounds invoked the choice of biological treatment for the waste water. End-of-pipe treatment was preferred because of the spatial limitations (lack of space) and because it provided an integrated solution for all the site waste water. The selected waste water treatment plant (WWT) involves a four-step approach involving: primary de-nitrification of nitrates, nitrification of Kjeldahl nitrogen, secondary de-nitrification, and settling. The WWT has a hydraulic capacity of 4500 m³/h and is designed to treat a load of 235 kg nitrates/h, 800 kg Kjeldahl nitrogen/h and 5600 kg COD/h. When built in 1978 it was the biggest industrial waste water treatment plant in Europe.

The realisation of the WWT resulted in a massive reduction in the pollutant load, thus satisfying the local authorities and the water suppliers. However, completion of the WWT hardly affected the operation of production facilities as operators / plant managers did not consider waste water as their responsibility. This was recognised in the mid-1980s with the introduction of information campaigns and accounting systems to assign WWT operational costs to individual plants. These systems made operators more aware of the consequences of their behaviour to the aquatic environment and resulted in reduced water use and the elimination of concentrated side-streams. Eventually the discharge to surface water reduced approximately 75 %.

Company B. Company B's strategy for the abatement of waste water was quite different in the early 1970s. One of the decisive factors was that the pollution load primarily consists of hydrocarbons and this widens the scope of possible treatment philosophies. The management level reticence about biological treatment and the absence of spatial limitations on the site invoked a plant-based strategy. This strategy included process-integrated measures, side-stream treatment and actions to increase environmental awareness of operators; for example:

- measurements on plant specific discharges: periodic reports; feedback of trends to operators and plant management; monitoring of contingencies; internal allocation of discharge costs
- active communication to all personnel
- investments in technical measures: stripping of volatile components on side-stream level combined with recovery or incineration, re-use of process condensates, exclusion of solvents.

This strategy resulted in a continuous reduction of the discharged load of pollutants, as well as a 60 % reduction in water use. A biological waste water treatment plant was finally built in 1995. The WWT has a hydraulic capacity of 1000 m³/h and is designed to treat a load of 6 kg

nitrites/h, 15 kg Kjeldahl nitrogen/h and 150 kg COD/h. The overall efficiency of the WWT is about 70 %. The design of WWT offers the opportunity for effluent re-use.

Conclusion. As the figure above shows, both strategies have been very successful in reducing the discharges of pollutants to the aquatic environment even though the production volume increased significantly during the period. Overall the relative discharge of pollutants to surface water amounts to 1 - 2 % of the emission in 1970. The two companies attained these reductions by a different combination of technical measures and organisational influences. These differences led to a WWT at Company A with a capacity of 1000000 PE and 40000 PE at Company B. The respective investment costs of these plants were $88 \cdot 10^6$ ECU and $41 \cdot 10^6$ ECU (price levels of civil projects in 1995).

These costs clearly demonstrate the benefit of scale for the Company A treatment plant. Nevertheless, the approach of Company B allowed the large capital investment to be postponed by several years and this brought considerable economic benefits. The subsequent source reduction of pollutant loads in Company A may result in over-capacity of the WWT thus undermining the original capital investment.

The end-of-pipe approach of Company A is shown to be more vulnerable to variations in economic situations. Because environmental awareness was not fully integrated into management systems, the increasing production levels in Company A resulted in elevated discharges of pollutants to surface water, whereas the preventive approach of Company B resulted in more stable discharges.

The differences in approach also resulted in different management systems. As a preventive approach is only effective if all personnel are committed to the company goals, all personnel need to be aware of the possible adverse consequences of their behaviour to the environment. In the case of Company B communication influencing the courses of action was one of the important levers in the reduction of waste water. Since the mid-1970s environmental issues have been discussed and managed throughout the organisation.

In the case of Company A, the WWT operation was appointed to a specific organisation that was responsible for the adequate treatment of all waste water originating from the many plants. For this purpose the management of the WWT made contracts with the individual plants concerning the quality and quantity of waste water. In the early years, the existence of this contract meant that there was no incentive to reduce waste water streams. Plant operators perceived that the reduction of water discharges was the responsibility of the WWT operator. As a result, there was little operational awareness of the link between daily plant activities and the discharge of waste water to surface waters.

At a later stage, the costs of WWT operation were attributed to the individual plants and so the discharge of waste water became an economic parameter. Consequently plant managers became aware of the issue of waste water, resulting in cost-effective side-stream measures. Subsequently the issue of waste water was re-introduced at working floor level. In the same period environmental awareness was also stimulated using other methods, for example by linking environmental performance with payment.

Resume. These descriptions of approaches to reduce emissions to surface water show that:

- technical measures and management aspects are equally important with respect to the reduction of discharges to surface water
- the choice for a particular strategy is dominated by local considerations taking into account the requirements of competent authorities. Hence, the abatement of waste water differs from case to case. However, the Company A case indicates that emission reduction based on end-of-pipe treatment alone may result in a less cost-effective operation
- awareness of the adverse consequences of behaviour on the (aquatic) environment is one of the main methods to control emissions.

ANNEX VI: USE OF CATALYSTS IN INDUSTRY

[InfoMil, 2000 #83]

The translation of an idea for a chemical product to a production process involves several stages. Besides criteria for the product itself the production of a chemical has to meet economic criteria as well as criteria concerning human health and the environment. The role of catalysts is of great importance in meeting these criteria.

Catalysts are compounds that enhance the reaction rate of chemical reactions. Basically a catalyst is considered to form an intermediate compound with some of the reactants to form desired product. Principally a catalyst does not change chemically in time. Catalysts are used in virtually any chemical production process. The catalyst composition varies depending on the product itself and the process used. Some industrial examples are as follows:

Examples of catalysts in chemical industry		
Process	Catalyst	Example
Friedel Crafts condensation	AlCl ₃	Polymers
Hydrogenation	Pt, Pd, Ni	Saturation of hydrocarbons Production of fats from oils
Oxo process	Co	Oxoalcohols
Oxychlorination	Cu	Ethylene dichloride
Ziegler Natta reactions	TiCl ₄ + aluminium alkylchloride FeCl ₃	Stereo specific polymers

In some processes compounds with indirect influence on reaction rate are (also) used, for example phase-transfer catalysts. In the production of polycarbonate, nitrogen-containing compounds are used for transport of condensation products (hydrogen chloride) from the solvent to the water phase. Traditionally catalysts are categorised as homogeneous or heterogeneous systems, with typical properties as follows:

Homogeneous catalysts	Heterogeneous catalysts
Present in the same phase (gas or liquid) as the reactants.	Present in a phase different from those of the reactants.
Offers the opportunity to vary between grades of products.	Only one product grade possible.
Usually follow rate equations which are first-order with respect to the catalyst concentration.	
Either integrated in the product or removed by (water) washing (often resulting in a waste water stream).	

Environmental aspects. The following table presents some emission factors comparing the use of homogeneous and heterogeneous catalysts in the combined production of styrene monomer and propylene oxide.

Emission factors for spent caustic (only) in styrene monomer / propylene oxide production *							
Plant		Emission factor					
No.	Capacity (kt/yr)	Homogenous catalyst			Heterogeneous catalyst		
		Catalyst (kg/tonne)	COD (kg/tonne)	flow (m ³ /tonne)	Catalyst (kg/tonne)	COD (kg/tonne)	flow (m ³ /tonne)
A	590 / 227	0.11	No data	0.208			
B	390 / 165				pm	no data	0.576
C	683 / 298				pm	58	0.498
D	640 / 285	0.14	90	0.356			

* Factors refer to the total production of MS and PO

Based on the figures in the table above, spent caustic will be contaminated with negligible amounts of catalyst (up to 120 tonnes per year) and 30 to 60 kilotonnes of by-products (expressed as COD). These amounts cannot be discharged directly to surface water and special treatment is necessary.

In the case of plant A spent caustic is injected in a deep well (which is considered an environmentally safe solution by competent authorities in the USA). In all the other cases techniques are used in order to reduce contamination (specifically the COD load). In the case of plant D, special attention is paid to the removal of catalyst from the waste water. Eventually the treated caustic is neutralised and discharged to surface water.

Spent caustic from plants C and D is incinerated. In the case of the plant using a homogeneous catalyst (plant D) additional cleaning of flue gases is necessary (wet scrubbing at low pH). The drain of the scrubbing system is treated using a selective ion-exchange resin. The regenerate of the ion exchangers is transported to a specialised company for recovery of the catalyst. The overall efficiency of catalyst removal is approximately 95 %. In case of plant D the remaining 5 % corresponds to annual discharge of 7 tonnes catalyst.

Plants using heterogeneous catalyst need to periodically reactivate the catalyst using steam. The resulting condensate is treated in a waste water treatment plant.

Catalyst selection. The catalyst choice for a production process is made using the criteria of (raw) product quality, consequences for human health, safety and environment and, of course, economics. These criteria are related to one-another. For instance, energy consumption is relevant for the production costs as well as for the environment (greenhouse effect). This is also the case for waste generation. In the latter cases economic and environmental aspects strengthen each other. The availability of a preferred catalyst is also important. Nowadays most catalysts are patented and companies using a patented catalyst need to pay a fee to the patent holder. In some cases patents are used by companies for strategic purposes, which may mean that catalysts are not available for other companies.

Resume. The selection of a catalyst is only one of the steps to be taken in the basic design of a production process. Catalysts are important for creating optimal process conditions. On the contrary catalyst may induce adverse effects to man or environment. This is especially the case for homogeneous catalysts. Additional measures are necessary to reduce these adverse effects.

ANNEX VII: ENVIRONMENTAL, HEALTH AND SAFETY ACTIVITIES DURING A PROCESSING PLANT PROJECT

Separate project steps can be identified in the development, engineering and construction of a chemical plant. During these phases, various environmental, health and safety (EHS) activities are required according to the nature of the process, the requirements of authorities, company policies, available process information and the site location. The environmental risks of plants vary and so the work required within the different development steps, and hence the EHS activities, differs between projects. This text describes some general guidelines for the project management to help define and manage EHS activities during the project phases. The development, engineering and construction of the production plant is divided into the eight phases, each with specific activities (see table below). Although the phases are separate, they are linked together and serve as logical decision points for project continuity [Finnish Environment Institute, 1999 #62].

Phase	Target	Basic data for the work	Work sequence	EHS activities during the phase
Research	Possibility, approval	<ul style="list-style-type: none"> - Innovation - Market survey, evaluation - Customer feed-back 	<ul style="list-style-type: none"> - Laboratory studies - Bench-scale operation - Pilot plant operation 	<ul style="list-style-type: none"> - Chemical safety data - Reaction matrix analysis - Hazardous material specifications - Preliminary life-cycle analysis
Conceptual design	Technical approaches	<ul style="list-style-type: none"> - Reaction mechanisms - Information on catalysts - Alternative site data - Company EHS policy - Materials for construction 	<ul style="list-style-type: none"> - Flowsheet development - Conceptual equipment sizing - Process alternatives development - Site evaluation 	<ul style="list-style-type: none"> - Conceptual energy optimise - Conceptual waste minimise - Environmental impact assessment - Consequence analysis - Preliminary hazard analysis - Potential problems analysis - Principles for fire / emergency systems - Product life-cycle analysis
Basic design	Technical solution	<ul style="list-style-type: none"> - Basis for design - Feed/product specification - Preliminary flow drawings - Site information - EHS requirements 	<ul style="list-style-type: none"> - Process optimisation - Automation / control development - Equipment sizing /specifications - Pilot plant development 	<ul style="list-style-type: none"> - Energy optimisation - Waste water minimisation - Waste minimisation - Noise level evaluation - Preliminary emission estimation - Hazard and operability study - Fire / emergency system specifications - Life-cycle analysis review
Detailed engineering	Final plant design	<ul style="list-style-type: none"> - Project plan - Flow drawings - Material/energy balance - PI drawings, equipment sizes - Preliminary plot plan 	<ul style="list-style-type: none"> - Final plant design - Utility systems design - Control system design - Equipment design 	<ul style="list-style-type: none"> - Final energy review - Final waste water review - Final noise level review - Emission estimation - Action error analysis - Fire / emergency system design
Construction	Building the plant	<ul style="list-style-type: none"> - Detailed design - Equipment design data - Equipment manufacturer data - PI drawings, equipment sizes 	<ul style="list-style-type: none"> - Purchasing of specified material and equipment - Construction activities - Work inspection - Operator training 	<ul style="list-style-type: none"> - EHS specifications for purchasing & inspection of material & equipment - Emergency plans - Operating manuals for safe operation - Personnel training - Construction work monitoring
Commissioning	Approval of construction	<ul style="list-style-type: none"> - As-built plant design - Documents - Approved authority requirements 	<ul style="list-style-type: none"> - Verification of design & construction work - Final authority approval - Operator training 	<ul style="list-style-type: none"> - Operator and maintenance personnel training - Fire & emergency training for operators - Testing fire / emergency systems
Start-up	Start of production	<ul style="list-style-type: none"> - Operating manuals - Safety procedures 	<ul style="list-style-type: none"> - Bringing plant to operating conditions 	<ul style="list-style-type: none"> - Review of operating manuals - Safety procedures review
Performance test	Final plant acceptance	<ul style="list-style-type: none"> - Performance guarantees 	<ul style="list-style-type: none"> - Performance test - Product quality verification 	<ul style="list-style-type: none"> - Energy use verification - Waste water quality/ quantity verification - Verification of emissions - Environmental audit

Whilst agreeing with this step-by-step approach to an industrial development project, CEFIC have made some additional comments, namely:

- Market, economic and financial analyses are all refined as a project develops.
- An investment cost estimation is carried out at each step with increasing accuracy.
- The selection of the site and the production capacity are important steps which have obvious environmental consequences.
- An industrial project usually has social consequences (e.g. employment, career development) which have to be addressed.
- Life Cycle Analysis is not common for LVOC products.
- The steps in project development have to match with the permitting procedures of Member States.
- Some steps are not relevant when the process is bought from a licensor rather than developed in-house.

1. Conceptual Design Phase

The conceptual design develops and evaluates alternative technical approaches of a production plant and justifies further development work needed for the project. The conceptual design may also study different plant locations, specify technical requirements of the project (e.g. feed and product qualities, waste and waste water treatment, evaluate different materials for plant construction) and investigate possible routes for further plant development. The conceptual design phase ultimately prepares an order of magnitude investment and running cost estimate indicating the preliminarily economics of the project. The input information to the conceptual design may be determined by research/development activities, and may include sources like the license owners, information from operating units or information from general literature sources. The input information of the conceptual design has to incorporate basic chemistry of the process including complete reaction mechanisms, reaction kinetics and thermodynamics within the process, physical properties of the process streams, methods for VLE estimates and basic information of the applicable plant construction materials.

Conceptual energy optimisation. The conceptual design phase includes the synthesis of the preliminary process flow diagram. During the synthesis several possible flow sheet approaches may be analysed. This development work gives the project owner a good opportunity to identify and to adjust the environmental impact the plant is going to have and also gives a possibility to direct the design work to meet all his needs. The development of the energy balance will give the project owner a possibility to study the energy consumption or energy production and also gives him a chance to optimise the process for several alternative design approaches. At the conceptual design stage it is necessary to find the main principles for energy use or production and to study how the utility systems at alternative sites can best be adjusted for the new project. It is not necessary to develop detailed energy recovery system for the production plant like an optimum heat exchanger network. In terms of Process Integration Technology it is necessary to prepare the composite curves and a grand composite curve for the separate alternative process approaches to support the energy analysis.

Conceptual waste minimisation. Below is a list of different techniques to minimise wastes within a process plant. During the conceptual design phase it is important to study all possible alternative approaches for an optimum waste minimisation, but the list may be used during the whole design.

Waste source reduction: Source control, Input substitution, Product reformulation, Technology modification, Good housekeeping practices.

Recycling (on-site / off-site): Process redesign, Re-use of ingredients, Effective substitutes, Recover usable products, Regeneration.

Waste treatment: Process design, Process modifications, Equipment changes, Energy conservation.

Environmental impact & Environmental impact assessment (EIA). In the European Union a special Environmental Impact Assessment (EIA) is required for large new chemical plants or for major retrofits according to specified criteria. The EIA covers all environmental aspects a production plant. This type of work should be done according to the Authority requirements. The requirements for this assessment specify when an EIA has to be made and what information the EIA has to contain. In case an EIA is required, the study will cover all environmental impact the plant may have. Also, the environmental study must normally cover alternative approaches and at least the alternative not to build the plant.

Principles for fire/emergency systems. At this stage we normally include the following items in the study:

- authority requirements to be followed
- preliminary calculation of fire water requirement
- preliminary investigation of fire water source
- preliminary estimation of fire fighting equipment
- preliminary estimation of fire fighting and emergency personnel.

Hazard and risk analyses. The main purpose for carrying out hazard and risk analyses for investment projects is to find out what kinds of accidents (fires, explosions, releases of substances hazardous to health or to environment, major equipment or product losses and product off-spec cases) are possible, and how they could occur. On the basis of the resulting information technical and operational actions are proposed, in order to prevent accidents, reduce their consequences or make them less probable.

Other purposes of hazard and risk analyses are:

- to find out information gaps
- to implement Inherent SHE (Safety-Health-Environmental friendliness)
- to review design
- to train staff (both design and operation)
- to improve quality of procedures
- to prepare material for training
- to produce documentation for different levels of project decision making (incl. the authorities)
- to collect information for dissemination to the public on (major) accident hazards/risks.

The following hazard and risk analyses should be considered at the conceptual design stage:

- reaction matrix
- consequence analysis
- preliminary hazard analysis (hazard mapping; alternative methods)
- Dow Fire & Explosion index (preliminary).

The methods to make these risk analyses are described in the Neste risk analysis manuals. For the Dow F&E index we apply the 6th edition (published by the AIChE, American Institute for Chemical Engineers).

Product life-cycle analysis. Product life-cycle analysis should be prepared at this stage. In general a product life-cycle analysis is a complex problem. The analysis covers an evaluation of raw material usage, yields, waste material generation, waste minimisation, energy consumption, product use and final disposal. As the technologies to manufacture and to use a product may vary and there are normally several possibilities for the raw materials, the life-cycle analysis are complex and mostly give information of a qualitative type.

2. Basic Design Phase

Energy optimisation. During the basic design stage, energy optimisation with the Pinch-analysis should be made to cover the process plant and the utility systems serving the plant. The utility optimisation shall be done if possible together with the overall plant energy optimisation. A site-wide analysis gives the best possibility to optimise the total energy needed for the plant. Site-wide analysis requires a considerable amount of expert work and the analysis should be judged before starting this kind of an effort.

Waste water minimisation. For the minimisation of the waste water amount a technology using the Pinch principles may be applied. The principles will give the target for the minimum fresh water and waste water amounts. The technology is described in the Pinch literature. The principles described earlier for the waste minimisation may be practised for the waste water minimisation as well.

Waste minimisation. The same principles given above at the conceptual design phase for the waste minimisation for a process plant are applicable again and will help to find the right methods for minimising the waste at a process plant.

Noise level evaluation. The noise level evaluation will be reviewed to verify the results on the noise level calculations made during EIA/ EA.

Preliminary emission estimation. Depending on the plant nature a preliminary estimation of plant emissions may be done. The estimation shall cover: Carbon dioxide, VOC, SO₂, NO_x and any other, for the process specific volatile, poisonous, smelling etc. emission.

Fire/emergency system specification. The fire/emergency system specification will be done according to the general engineering practice described in the basic design guidelines.

Hazard and risk analyses. At this stage the process has been selected, the location has been decided, and the design thinking is well developed. Major changes to the process can still be made. Process flow diagrams are usually available. Ranking of units (high, medium or low risk) in respect to explosion, fire, toxicity and environmental risks will be done by risk analysis methods like Dow Fire & Explosion index and Chemical Exposure index. The most critical units/stages/areas are studied with a Hazard and Operability Study (HAZOP) or another respective detailed method. The main results of these analyses will give the basis for modifications in layout and other design solutions, by which the main risks of the process or the storage could be minimised or eliminated. The analyses also give assistance in deciding where to direct a detailed risk study.

Product life-cycle analysis review. A review is made to verify the life-cycle analysis prepared during the conceptual design stage.

3. Detailed Engineering

Final energy review. During the detailed engineering phase some design changes may occur. To adjust the energy requirement/production to the optimum a Pinch-analysis is again repeated. The purpose is to check that the design still represents the wanted optimum design. If the optimisation during the basic design phase has been done with Process Integration technology normally only minor changes are needed to adjust the final design to optimum energy use.

Final waste water review. During the detailed engineering the amount and quality of different waste waters streams should be reviewed to verify the information developed during the earlier design steps. This information should cover all waste water streams the plant under design will produce.

Final waste review. During the detailed engineering a review of the amount and quality of the different wastes should be done as well in order to verify the information developed during the earlier design steps. This information must cover all the wastes the plant under design will produce.

Final noise level review. The final noise review should be done to verify the noise level calculation made for EIA/EA. The review is made to analyse possible changes needed to control the noise level.

Emission estimation. The final emission estimation will be done based on the information developed during the detailed engineering. The estimation shall cover the evaporative components specified earlier in the section of Basic Engineering Phase.

Fire/Emergency system design. The final detailed engineering for the fire/emergency system is done according to the detailed engineering guidelines.

Hazard and risk analyses. At this stage all the main design decisions have been made. There is still space for fine-tuning and the preparation of operation and special procedures requires an information package on possible serious disturbances. Well-thought PI-diagrams are now available. The hazard and operability studies (HAZOPs) for those units not covered earlier are now carried out. NOTE: HAZOPs etc. should - at least partly - be carried out during the basic design, if possible.

We basically rank the units based on Dow Fire & Explosion in three Classes. During the early detailed engineering stage the following hazard studies are proposed for the different Classes:

- **High rank:** Detailed identification of hazards by Hazard and Operability Study - HAZOP (or Hazard Mapping); in selected cases Action Error Analysis for analysing human errors. Eventual completion and at least checking / updating of the Consequence Analysis that was done earlier.
- **Medium rank:** Identification of hazards by Hazard Mapping (or HAZOP). Consequence Analysis

During the later detailed engineering stage the following hazard studies can be judged:

- **High rank:** Possibly identification of critical human errors, before finalising the respective procedures (Action Error Analysis).
- **Medium rank:** Action Error Analysis
- **Low rank:** An expert report on the main hazards (should preferably be prepared initially already at an earlier stage). HazOp or Potential Problems Analysis.

The necessary changes of the design decided on the basis of the hazard and risk analyses shall be done as part of the detailed engineering work.

4. Purchasing / Construction Phase

During the purchasing phase the suppliers of the plant equipment and material are selected. It is obvious that the purchased equipment and material must fulfil the plant environmental, health and safety requirements.

EHS-Requirement specifications for material and equipment purchasing. All equipment and material must be purchased according to written specifications. The equipment and material specifications must be in accordance with the plant EHS-requirements. Special attention shall be

paid on the machinery noise level, the equipment maintenance practices and - in case the equipment will contain evaporative hydrocarbons - on the possibilities to minimise the leakage.

EHS-Requirement specifications for inspection of purchased material. Neste has prepared general requirements for inspection of purchased material and these guidelines state how to inspect the requirements set by EHS-specifications.

Emergency plans. Emergency plans will be prepared to show how upset situations will be organised and handled.

Operating manual for safe operation. The operating manual for safe operation will be prepared according to the available information and documentation. The manual will be revised according to the information received from equipment suppliers etc.

Operator and maintenance personnel training for safe operating practices. The training of operating and maintenance personnel will be started. During the training also the results of risk studies are utilised in the preparation of training material and as direct training material.

Construction work safety monitoring. At Neste a separate in-house practice covers safety aspects at the construction work. The same practice is used to monitor construction work safety as well.

5. Commissioning Phase

Operator and maintenance personnel training for safe maintenance. All operators and maintenance personnel have to be trained for safe maintenance practices. Neste - as normally most companies - has written training procedures and written guidelines for safe maintenance of all equipment.

Fire and emergency training for operators. Every operator has to be trained for initial fire fighting and sound first aid practices.

Testing of fire and emergency systems. It is checked that construction is according to design. During the testing the functioning of all systems will be secured and probable 'unsuitable' design solutions are also revealed.

6. Start-up Phase

Start-ups, especially the first start-up, normally gives plenty of experience regarding the safety. At Neste we try to collect this experience and review our operating manuals and safety procedures shortly after start-up. After the first start-up we also measure and verify the noise level.

7. Performance Test

After the start-up a performance test may be done. During this test beyond normal production performance measurement also the energy use of the plant, the generation and the quality of waste water, the formation and the amount of waste and the plant emission is verified. As a last step for a new production plant an environmental audit can be done. These audits are proposed to be done according to standard methods like ISO 14000 or BSI 7700.

ANNEX VIII: MEMBER STATE AIR POLLUTANT CLASSIFICATION SYSTEMS

A. Dutch classification for air emissions

The following text is a translation of the Dutch NeR Classification system.

3.2 'General emission standards

3.2.1 Extremely hazardous substances

Some substances are so dangerous (to the environment) that emissions should in principle not occur at all. Such substances are regarded as extremely hazardous. For the process emissions of such substances the aim must be to achieve zero level emissions, i.e. that no emission takes place at all. This is referred to as compulsory minimisation (refer to §2.3.7).

For extremely hazardous substances no limit mass flow or emission standard applies but the requirement to minimise emissions applies instead.

A substance is categorised as Extremely Hazardous on the basis of extreme toxicity, persistence and tendency towards accumulation.

Extremely hazardous substances

	Name of substance
	polybromine dibenzodioxins
	polybromine dibenzofurans
	polychlorinated biphenyls (PCB)
	polychlorinated dibenzodioxins (PCDD)
	polychlorinated dibenzofurans (PCDF)
	polyhalogenated dibenzodioxins
	polyhalogenated dibenzofurans

3.2.2 Emission standards for carcinogenic substances

Carcinogenic substances can be subdivided into carcinogens with a threshold level - i.e. that carcinogenic effects only occur above a certain dose - and carcinogens without a threshold level.

On the basis of information on the carcinogenic properties of various substances originating from both the EC and the International Agency for Research on Cancer (IARC) a list of carcinogenic substances has been drawn up.

This list has been supplemented by the list of substances used in the required registration of hazardous substances within the framework of the labour conditions legislation and has been harmonised with the list of compounds which are classified as such in TA-luft (1986 version).

For the purposes of the NeR the following substances are regarded as carcinogenic:
Substances with an EC classification:

- 1C 'Carcinogenic to man on the grounds of epidemiological research findings', and
- 2C 'Carcinogenic to man on the grounds of evidence in particular from chronic animal testing'

Substances with an IARC classification:

- 1 'Carcinogenic to man', or
- 2A 'Likely to be carcinogenic to man'

Carcinogens are subdivided into two groups in the NeR:

carcinogens with a threshold value, in which the carcinogenic effect only occurs above a certain concentration, and
carcinogens without a threshold value for which carcinogenic effects can occur independently of the dose.

Carcinogens with a threshold value are classified in accordance with the category to which they belong on the basis of their physical/chemical properties. The carcinogenic substances without a threshold value are classified into one of these three classes on the grounds of the immission concentration which introduces a risk of one additional case of cancer per one million people.

class	concentration ($\mu\text{g}/\text{m}^3$)
C.1	<0.001
C.2	≥ 0.001 and < 0.1
C.3	≥ 0.1

Where this concentration has not been determined yet, the same classification is used as in TA-luft (1986).

For 2-nitropropane neither of these classifications can be used. For safety reasons, this substance has therefore been classified as a C.1 substance.

In the 80s lists were drawn up within various policy frameworks of substances for which all emissions to air must be controlled vigorously, the so-called Black List substances. These Black List substances are no longer part of the policy formulated in the NEPP (National Environmental Policy Plan). For this reason they are not incorporated as such into the NeR.

At the local level the authorities can obviously adopt points of departure for their policies in order to also reduce the emissions of such substances to the minimum levels possible.

Carcinogens without a threshold value

For carcinogens without a threshold value no minimum dose has been fixed below which no carcinogenic effects can be expected. Here compulsory minimisation applies (refer to §2.3.7)

In the case of carcinogens without a threshold value the cumulation rule applies and also the following considerations:

Class C.1

In the case of an untreated mass flow of 0.5 grams per hour or more an emission standard of $0.10 \text{ mg}/\text{m}_0^3$ applies.

Class C.2

In the case of an untreated mass flow of 5.0 grams per hour or more an emission standard of $1.0 \text{ mg}/\text{m}_0^3$ applies.

Class C.3

In the case of an untreated mass flow of 25 grams per hour or more an emission standard of $5.0 \text{ mg}/\text{m}_0^3$ applies.

Carcinogenic substances (C1, C2 and C3)

	Name of substance*	Remark	Class
	Benzo(a)anthracene		C.1
	Benzo(a)pyrene		C.1
	Benzo(b)fluoranthene		C.1
	Benzo(j)fluoranthene		C.1
	Benzo(k)fluoranthene		C.1
	Beryllium and its compounds, calculated as Be		C.1
	Chromium(VI) compounds, calculated as Cr		C.1
	Dibenzo(a,h)-anthracene		C.1
2-	Naftylamine (+ salts)		C.1
2-	Nitropropane		C.1
	Diethyl sulphate		C.2
	Dimethyl sulphate		C.2
	Ethene oxide	refer to: 1,2-epoxyethane	C.2
	Ethylene oxide	refer to: 1,2-epoxyethane	C.2
	Nickel and its compounds, calculated as Ni		C.2
1,2-	Epoxyethane		C.2
3,3-	Dichlorobenzidine (+salts)	refer to: 3,3'-dichloro-(1,1'-biphenyl)	C.2
3,3'-	Dichloro-(1,1'-biphenyl)		C.2
	Acrylonitrile	refer to: propenenitrile	C.3
	Benzene		C.3
	Buta-1,3-diene		C.3
	Butadiene	refer to: buta-1,3-diene	C.3
	Chloroethene	refer to: vinyl chloride	C.3
	Epichlorohydrine		C.3
	Hydrazine (+salts)		C.3
	Propenenitrile		C.3
	Propene oxide	refer to: 1,2-epoxypropane	C.3
	Propylene oxide	refer to: 1,2-epoxypropane	C.3
	Vinyl chloride		C.3
1-	Chloro-2,3-epoxypropane	refer to: epichlorohydrine	C.3
1,2-	Dibromomethane		C.3
1,2-	Dichloroethane		C.3
1,2-	Epoxypropane		C.3

* For CAS numbers see Appendix 4.5

Polycyclic aromatic hydrocarbons (PAHs)

A subset of the various PAHs has been classified as carcinogenic without a threshold value and therefore is subject to compulsory minimisation stated in the NeR. In actual practice, in the case of measurements and requirements also various 'less hazardous' aromates are included in PAH-analyses.

Below a listing is given of several common PAHs, their classification and customary analysis techniques.

Polycyclic aromatic hydrocarbon	NeR	EC/IARC	NVN2816	note
Acenaphthene				e
Acenaphthylene				e
Anthracene	(sO.1)		yes	le
<i>Benzo(a)anthracene</i>	<i>C.1</i>	<i>2C/2A</i>	<i>yes</i>	<i>le</i>
<i>Benzo(a)pyrene</i>	<i>C.1</i>	<i>2C/2A</i>	<i>yes</i>	<i>ble</i>
<i>Benzo(b)fluoranthene</i>	<i>C.1</i>	<i>2C/2B</i>	<i>yes</i>	<i>be</i>
Benzo(b)fluoranthene				
Benzo(e)pyrene			yes	
Benzo(g,h,i)perylene			yes	ble
<i>Benzo(j)fluoranthene</i>	<i>C.1</i>	<i>2C/2B</i>		
<i>Benzo(k)fluoranthene</i>	<i>C.1</i>	<i>2C/2B</i>	<i>yes</i>	<i>ble</i>
Chrysene ¹⁾			yes	le
Coronene			yes	
Debenzo(a,e)pyrene		/2B		
<i>Debenzo(a,h)anthracene</i>	<i>C.1</i>	<i>2C/2A</i>	<i>yes</i>	<i>e</i>
Debenzo(a,h)pyrene		/2B		
Debenzo(a,i)pyrene		/2B		
Debenzo(a,j)anthracene			yes	
Debenzo(a,l)pyrene		/2B		
Dibenzo(a,h)acridine		.../2B		
<i>7H-dibenzo-(c,g)carbazol</i>		.../2B		
3,6-dimethyl-phenanthrene			yes	
Fluoranthene			yes	ble
Fluorene				e
Indeno(1,2,3-c,d)pyrene 1)		/2B	yes	ble
<i>3-methyl-cholanthrene</i>				
<i>5-methyl-chrysene</i>		.../2B		
Nafthalene	O.2			l
Phenanthrene			yes	le
Pyrene			yes	e

note ¹⁾: in the PAH criteria assessment document this substance is listed as carcinogenic (RIVM report 758474007)

The compounds listed in *italics* are carcinogenic according to Annex A of the requirements for registration of hazardous substances, module 5 of the information system for toxic substances to be used in applying working conditions legislation, November 1991

Legend for referral markings next to the remarks:

b = PAHs according to Borneff

l = PAHs according to Guideline for Soil Sanitation, 1988

e = PAHs according to EPA

Carcinogens with a threshold value

The following applies to carcinogens with a threshold value:

*Asbestos (class sA.1)*¹

In the case of an untreated mass flow of 1.0 gram per hour or more a maximum emission concentration of 2 fibres per cm³ applies, corresponding to an emission standard of 0.10 mg/m₀³

Arsenic and its compounds (class sA.1), calculated as As

In the case of an untreated mass flow of 1.0 gram per hour or more an emission standard of 0.20 mg/m₀³ applies.

Cadmium and its compounds (class sA.1), calculated as Cd

In the case of an untreated mass flow of 1.0 gram per hour or more an emission standard of 0.20 mg/m₀³ applies.

¹ In accordance with EC directive 87/217/EEC, a more stringent emission standard applies than for other substances in class sA.1.

Formaldehyde (class O.1)

In the case of an untreated mass flow of 0.10 kilogram per hour or more an emission standard of 20.0 mg/m₀³ applies.

Silica (silicon dioxide) (class sA.1), in particular cristoballite, tridymite and respirable quartz

in the case of an untreated mass flow of 1.0 grams per hour or more an emission standard of 0.20 mg/m₀³ applies.

Respirable quartz

Silica (quartz) is often released during the processing of material containing sand ((sand) blasting stone or brick, abrasive finishing of concrete surfaces, grinding operations etc). For respirable quartz a low MAC value applies (0.075 mg/m³). In order to achieve this value at the work site air evacuation at the source or high-volume ventilation is utilised. In the latter case the rule applies that if the MAC value is met at the work site the ventilation air being discharged always satisfies the NeR emission standard. Verification by measurement of the emission is not required in this case.

If air evacuation at the source is utilised the concentration of quartz and other silicates in the waste gas may be higher than the requirements indicate. In that case an end-of-pipe dust separator and verification through measurements is required (refer to §3.7.2).

3.2.3. Emission standards for particulates

For the category particulates no limit mass flow has been determined to date.

For emissions of particulates in general (indicated as category S) the rule applies that waste gas flows in the case of an untreated mass flow smaller than 0.50 kilograms per hour may contain a maximum of 50 mg/m₀³ particulates, and in the case of fabric filters, metal-type filters or similar filtering separators a maximum of 10 mg₀³. In the case of such small sources of particulates it may be unreasonable for reasons of cost effectiveness to demand that measures are taken. In such situations the competent authorities may deviate on duly stated grounds from the concentration requirements.

In the case of an untreated mass flow larger than or equal to 0.5 kilograms per hour – assuming that the waste gas parameters allow it – application of filtering separators must be aimed for. In that case an emission standard of 10 mg/m₀³ applies. Where such filtering separators cannot be used due to the specific waste gas parameters, in principle an emission standard of 25 mg/m₀³ applies. If the Best Available Control Technology makes it necessary in special situations to deviate on duly stated grounds from this requirement then a limit value a maximum of 50 mg/m₀³ may be stipulated.

Particulates, category S

Name of substance*	Remarks	Class
Aluminium and its compounds		S
Benzyltributyl-ammonium 4-hydroxy-naphthalene-1-sulphonate		S
Borium and compounds in particulate form		S
Compounds of calcium, with the exclusion of calcium oxide		S
Carbon black		S
Graphite		S
Wood dust (particles <10 mm)		S
Iron oxide (Fe ₃ O ₄)		S
Magnesium compounds		S
Molybdenum and its compounds		S
Polymethylmethacrylate		S
Polyvinyl alcohol		S
Polyvinylidene fluoride		S
Portland cement		S
Silicon dioxide (amorphous)		S
Particulates		S
Titanium dioxide		S
Sand and other silicon-compounds, with the exception of crystalline and/or fibrous compounds		S
Zinc and its compounds, with the exception of zinc chromate and zinc chloride (fume)	4)	S
Zinc stearate		S
Zirconium	provisional classification	S
Zirconium oxide	provisional classification	S

* For CAS numbers refer to Appendix 4.5.

4) Fume is defined here as condensed metal vapour.

Unless explicitly indicated otherwise in a special regulation, 'particulates' will mean solid particles suspended in air, refer to §2.10 for details.

For the classification of specific substances or materials, refer to §3.2.4 and 3.2.5.

In the emission standards applicable to particulates it is indicated that, in the case of filtering separators being used, a requirement of 10 mg/m₀³ may be stipulated.

In the case of an untreated mass flow larger than or equal to the limit mass flow – assuming that the waste gas parameters allow it – application of separators of this type must be pursued.

Filtering separators

Filtering separators can generally be utilised if the untreated mass flow (possibly after a pre-treatment) meets the following conditions:

temperature	< 250 °C for fabric filters
	< 80 °C for metal-type filters
relative humidity	< 90 %
particle size (d _p)	> 0.1 µm

In this case the filters should comply with the indicative specifications listed below (NeR research into particulates/Haskoning):

surface load of fabric	1 - 2	m ³ /m ² .minute for fabric filters
surface load of fabric	1.3	m ³ /m ² .minute for metal-type filters
pressure drop over filter (across the fabric)	70 - 80	mbar for fine fabric filters
	15 - 25	mbar for coarse fabric filters
	2.5	mbar for very coarse fabric filters
	40	mbar for metal-type filters

possible problems associated with application: potential solution:

hygroscopic substances	heating of filter fabric
sticky substances	pre-coating of fabric used in filter
danger of explosion	explosion safe design of the filter

If it is necessary to pre-treat the waste gas flow (for example by cooling) in order to allow the application of filtering separators this may result in a diminished cost effectiveness of this device if this pre-treatment is not integrated with emission control of other substances or materials.

3.2.4. Emission standards for inorganic substances

Inorganic substances are subdivided into particulate inorganic substances and gaseous or vaporous inorganic substances².

Particulate inorganic substances (Category sA)

In the case of particulate inorganic substances the cumulation rule applies and also the following considerations:

Class sA.1

In the case of an untreated mass flow of 1.0 gram per hour or more an emission standard of 0.20 mg/m₀³ applies.

Class sA.2

In the case of an untreated mass flow of 5.0 grams per hour or more an emission standard of 1.0 mg/m₀³ applies.

Class sA.3

In the case of an untreated mass flow of 25 grams per hour or more an emission standard of 5.0 mg/m₀³ applies.

If during the venting of waste gases physical conditions (pressure, temperature) occur resulting in the above-mentioned components to be present in substantial amounts in a vaporous or gaseous form, then the applicable concentrations must also be applied to the total of all particulate, gaseous and vaporous emissions. This does not apply if separate requirements are mentioned in the category gaseous and vaporous inorganic substances for the gaseous and vaporous emission concerned.

² A basic list of inorganic substances has been compiled by complementing the list from the TA-luft (1) with those substances of which, according to the Emission Registration for Air (ER-L), more than 1000 kg per year is emitted into the atmosphere. Substances of which, according to the "ER-L", smaller amounts are emitted than 1000 kg per year were removed from the list for the time being.

Name of substance ^{*)}	Remark	class
Arsenic and its compounds, calculated as As	carcinogenic ¹⁾	sA.1
Cadmium and its compounds, calculated as Cd	likely carcinogenic ¹⁾	sA.1
Cristoballite		sA.1
Iron pentacarbonyl		sA.1
Ceramic fibres		sA.1
Quartz, respirable (crystalline silica)	likely carcinogenic ¹⁾	sA.1
Mercury and inorganic mercury compounds, calculated as Hg		sA.1
Platinum compounds, calculated as Pt	³⁾	sA.1
Rhodium compounds, calculated as Rh	³⁾	sA.1
Silica fibres, especially cristoballite and tridymite, and respirable quartz	likely carcinogenic ¹⁾	sA.1
Slag wool fibres		sA.1
Thallium and its compounds, calculated as Tl		sA.1
Tridymite		sA.1
Vanadium compounds, especially vanadium oxides, halides and sulphates, and vanadates, calculated as V		sA.1
Silver and its compounds, calculated as Ag		sA.1
Chromyl chloride		sA.2
Glass wool fibres		sA.2
Cobalt (fume) and cobalt compounds, calculated as Co	⁴⁾	sA.2
Copper fume, calculated as Cu	⁴⁾	sA.2
Lead and inorganic lead compounds, calculated as Pb		sA.2
Lead molybdate	refer to: lead and its compounds ³⁾	sA.2
Rhodium and its compounds (non-soluble in water), calculated as Rh	³⁾	sA.2
Selenium and its compounds, calculated as Se		sA.2
Rock wool fibres		sA.2
Tellurium and its compounds, calculated as Te		sA.2
Antimony and its compounds, calculated as Sb		sA.3
Barium and its compounds, calculated as Ba		sA.3
Calcium fluoride	⁹⁾	sA.3
Calcium oxide		sA.3
Chromium and its compounds, calculated as Cr (excluding the Cr(VI) compounds mentioned in §2.3.1.)		sA.3
Cyanides, calculated as CN		sA.3
Fluorides, calculated as F		sA.3
Fluorspar	⁹⁾ refer to: calcium fluoride	sA.3
Potassium ferricyanide	refer to: cyanides	sA.3
Potassium hydroxide		sA.3
Copper and its compounds, calculated as Cu, with the exception of copper fume		sA.3
Manganese (fumes) and manganese compounds, calculated as Mn	⁴⁾	sA.3
Sodium hydroxide		sA.3
Palladium and its compounds, calculated as Pd		sA.3
Platinum and non-water-soluble platinum compounds, calculated as Pt		sA.3
Tantalum	⁹⁾	sA.3
Tin and inorganic tin compounds, calculated as Sn		sA.3

Vanadium, vanadium alloys and vanadium carbide, calculated as V		sA.3
Yttrium	9)	sA.3
Yttrium oxide	9)	sA.3
Zinc chloride (fume)		sA.3

⁹⁾ For CAS numbers refer to Appendix 4.5

¹⁾ Refer to §3.2.2

³⁾ The requirements are based on all substances belonging to these classes, unless it only concerns emissions of substances non-soluble in water, in which case a requirement as listed in a class which is one number higher becomes applicable.

⁴⁾ Fume in this context means condensed vapour of metals.

⁹⁾ Provisional classification

Classification of particulate inorganic substances

Particulate inorganic substances have been classified on the grounds of the MAC value into one of the 3 following classes:

class	MAC value mg/m ₀ ³
sA.1	<0.1
sA.2	≥ 0.1 and <0.5
sA.3	≥ 0.5

If more than one MAC value applies to a group of substances, the lowest value will be the norm. Although the classification system does not recognise an upper limit, substances which can be regarded as relatively non-hazardous may be considered as 'particulates'. These substances must then meet the requirements of the category 'particulates, general (S)'.

The following inorganic substances will not be counted as belonging to category sA.3 but to class S:

CAS number	Substance
(..)	Aluminium and its compounds
(..)	Borium and compounds in particulate form
(..)	Calcium compounds
(1305-78-8)	with the exception of calcium oxide
(7782-42-5)	Graphite
(..)	Magnesium compounds
(..)	Molybdenum and its compounds
(..)	Portland cement
(..)	Sand and other silicon compounds
	with the exception of crystalline and/or fibrous compounds
(13463-67-7)	Titanium dioxide
(..)	Zinc and its compounds with the exception of
(13530-65-9)	zinc chromate
(7646-85-7)	zinc chloride (fume)

Classification of fibrous particulates

Fibre here will mean: a particle with a length in excess of 5 µm, a width of less than 3 µm and a length/width ratio of more than 3:1. (Guidelines of the Council of the European Communities dated 19 March 1987; 87/217/EEC).

Ceramic and slag wool fibres must be placed on a par with silica fibres as far as the hazard that they represent is concerned; they can therefore be classified as Class sA.1 substances.

In circles concerned with labour conditions the risk posed by glass and rock wool fibres is estimated a factor 5 lower (Working with glass and rock wool, Ministry of Social Services and

Employment, 1991). For emissions of such fibres it is therefore acceptable to apply the regulation for substances of class sA.2.

Gaseous or vaporous inorganic substances (Category gA)

The cumulation rule is not applicable to gaseous or vaporous inorganic substances.

Class gA.1

In the case of an untreated mass flow for each substance of 10 grams per hour or more an emission standard of 1.0 mg/m_0^3 applies.

Class gA.2

In the case of an untreated mass flow for each substance of 50 grams per hour or more an emission standard of 5.0 mg/m_0^3 applies.

Class gA.3

In the case of an untreated mass flow for each substance of 300 grams per hour or more an emission standard of 30 mg/m_0^3 applies.

Class gA.4

In the case of an untreated mass flow for each substance of 5.0 kilograms per hour or more an emission standard of 200 mg/m_0^3 applies.

Reference value for oxygen availability

For substances of Class gA4, in the case of emissions originating from incineration the requirements apply to circumstances of 3 % oxygen availability, and in the case of process emissions they apply to circumstances of normal oxygen availability under typical process conditions, unless it has been explicitly provided for otherwise in a special regulation.

Gaseous or vaporous inorganic substances (gA1, gA2, gA3, gA4)

Name of substance ^{*)}	remark	class
Arsenic trihydride (arsine)		gA.1
Cyanogen chloride		gA.1
Chlorine dioxide		gA.1
Phosphorus trihydride (phosphine)		gA.1
Phosgene		gA.1
Diborane (B ₂ H ₆)		gA.1
Hydrogen cyanide (HCN)		gA.2
Borium trifluoride		gA.2
Bromine and its compounds, calculated as HBr		gA.2
Chlorine gas (Cl ₂)		gA.2
Hydrogen cyanide (HCN)	refer to: prussic acid	gA.2
Fluorine and its compounds, calculated as HF		gA.2
Phosphoric acid		gA.2
Germanium hydride (GeH ₄)		gA.2
Silicon tetrafluoride		gA.2
Silicon tetrahydride		gA.2
Hydrogen iodide	provisional classification	gA.2
Hydrogen sulphide		gA.2
Sulphuric acid		gA.2
Borium trichloride		gA.2
Nitrogen trifluoride		gA.2

Chlorine compounds, calculated as HCl	gA.3
Nitric acid (mist)	gA.3
Silicon tetrachloride	gA.3
Trichlorosilane	gA.3
Sulphur hexafluoride	gA.3
Dichloro-silicondihydride	gA.3
Ammonia	gA.4
Nitric oxides, calculated as NO ₂	gA.4
Oxides of sulphur, calculated as SO ₂	gA.4

^{*)} For CAS numbers refer to Appendix 4.5

Classification of gaseous or vaporous inorganic substances (category gA)

Vaporous or gaseous inorganic substances have been classified on the grounds of the MAC value into one of the 3 following classes:

class	MAC value mg/m ₀ ³
gA.1	<0.5
gA.2	≥0.5 and <3
gA.3	≥3

According to the above classification system, ammonia would have to be classified as Class gA.3. However, for pragmatic reasons ammonia has been classified as Class gA.4. Best Available Control Technology in many situations allows residual emissions to be achieved which are better than the range of 30 to 200 mg/m³. Where it is known that in a specific emission situation a concentration of less than 200 mg/m³ is feasible, special regulations have been laid down which reflect this state of affairs. Ammonia can perhaps be classified as Class gA.3 if further information on the residual concentration which is achievable when using Best Available Control Technology in the case of sources which are not covered by special regulations suggests such a course of action.

Oxides of sulphur and nitrogen have been classified as Class gA.4 on the grounds of the technical options available for emission reductions.

Hydrogen sulphide has been classified as Class gA.2 on the grounds of the low concentrations in which it can be detected as a smell.

Pending a formal classification, emissions of sulphuric acid (7664-93-9) and phosphoric acid (7664-38-2) (mist) will be regulated in accordance with class gA.2, and nitric acid (7697-37-2) (mist) in accordance with class gA.3.

3.2.5. Emission standards for organic substances

In Appendix 4.5 organic substances (category O) have been classified into different classes, O.1 through O.3. This list with organic substances is not exhaustive and if necessary substances can be added on the basis of the classification system indicated in the accompanying comments.

For the various organic substances the following emission standards apply. In this case the cumulation rule applies.

Solvents Directive

Due to the EC Solvents Directive, for emissions of organic substances used in specific industrial processes separate requirements apply. These have been incorporated into the Decree on volatile organic substances and solvents. These requirements take precedence over the requirements in the NeR. A list of the activities affected can be found in §2.8.2.

In addition, special regulations apply for a number of activities in which organic substances might be released. These are included in §3.4. In §2.8.4.6 it is indicated how these must be applied.

Gaseous and vaporous organic substances

Class gO.1

In the case of an untreated mass flow of 0.10 kilograms per hour or more an emission standard of 20 mg/m³ applies.

Class gO.2

In the case of an untreated mass flow of 2.0 kilograms per hour or more an emission standard of 100 mg/m³ applies.

Class gO.3

In the case of an untreated mass flow of 3.0 kilograms per hour or more an emission standard of 150 mg/m³ applies.

Gaseous and vaporous organic substances (O1, O2, O3)

	Name of substance ^{*)}	Remark	Class
	Acetaldehyde	refer to: ethanal	O.1
	Acenaphthene		O.1
	Acenaphthylene		O.1
	Acrolein	refer to: propenal	O.1
	Acrylic acid	refer to: propenoic acid	O.1
	Acrylic ester	refer to: ethyl propenoate	O.1
	Acrylic methyl ester	refer to: methyl propenoate	O.1
	Alkyl lead compounds		O.1
	Aminobenzene		O.1
	Aminoethane	refer to: ethylamine	O.1
	Aminomethane	refer to: methylamine	O.1
sec-	Amylacetate		O.1
	Aniline	refer to: aminobenzene	O.1
	Acetic anhydride		O.1
	Aziridine	²⁾ refer to: ethylenimine	O.1
	Benzalchloride	⁹⁾	O.1
	Benzo(g,h,i)perylene		O.1
	Benzotrichloride	⁹⁾	O.1
	Benzylbutylphthalate	⁹⁾	O.1
	Benzylchloride		O.1
2,2-	Bis (4-hydroxyphenyl)propane		O.1
	Bisphenol A	refer to: 2,2 bis (4-hydroxyphenyl)propane	O.1
	Bromodichloromethane	⁹⁾	O.1
	Butylacrylate		O.1
	Caprolactam		O.1
	Cetylpyridinium chloride		O.1
	Chloroacetaldehyde	refer to: 2-chloroethanal	O.1
	Chloroacetic acid		O.1
2-	Chloroethanal		O.1
	Chloromethane		O.1
a-	Chlorotoluene	refer to: benzylchloride	O.1
	Chloroform	refer to: trichloromethane	O.1
	Cresols	refer to: methylphenols	O.1
	Di(2-methylpropyl)phthalate		O.1
1,2-	Diaminomethane	⁹⁾	O.1
2,4-	Dibromophenol	⁹⁾	O.1
1,2-	Dichlorobenzene		O.1
1,1-	Dichloroethylene		O.1
	Dichlorophenol(s)		O.1

	Diethylamine		O.1
	Diisobutylphthalate	refer to: di(2-methylpropyl)phtalate	O.1
	Dimethylamine		O.1
N,N-	Dimethylaniline		O.1
	Dimethylisopropylamine	9)	O.1
	Dimethylmercaptan	9)	O.1
	Dinonylphtalate		O.1
1,4-	Dioxane		O.1
	Distearyldimethylammonium bisulphate		O.1
	Distearyldimethylammonium methosulphate		O.1
	Ethanal		O.1
	Ethylenimine	2)	O.1
	Ethylacrylate	refer to: ethyl propenoate	O.1
	Ethylamine		O.1
	Ethylpropenoate		O.1
	Phenanthrene		O.1
	Phenol		O.1
	Formaldehyde	refer to: methanal; likely carcinogenic	O.1
2-	Furaldehyde		O.1
	Furfural; furfurol	refer to: 2-furaldehyde	O.1
	Glyoxal		O.1
1,6-	Hexanediisocyanate		O.1
	Hexafluoropropene		O.1
	Hexamethylenediisocyanate		O.1
	Isopropyl-3-chlorophenyl carbamate	9)	O.1
	Isopropylphenyl carbamate	9)	O.1
	Mercaptans	refer to: thioalcohols	O.1
	Methacrylic methylester	refer to: methyl-(2-methyl)-propenoate	O.1
	Methanal		O.1
2-	Methoxyethylacetate		O.1
	Methyl-(2-methyl)-propenoate		O.1
	Methylacrylate	refer to: methyl propenoate	O.1
	Methylamine		O.1
2-	Methylaniline		O.1
	Methylbromide		O.1
	Methylchloride	refer to: chloromethane	O.1
	Methylethylketoneperoxide		O.1
	Methylphenols		O.1
	Methylmethacrylate	refer to: methyl-(2-methyl)-propenoate	O.1
	Methylpropenoate		O.1
	Formic acid		O.1
	Nitrobenzene		O.1
	Organostannic compounds		O.1
	Peracetic acid		O.1
	Piperazine	9)	O.1
	Propenoic acid		O.1
	Propenal		O.1
n-	Propylamine	9)	O.1
	Pyridine		O.1
	Tethylhexylacrylate	9)	O.1
	Terphenyl (hydrogenated)		O.1
	Tertiary butylhydroperoxide (tbhp) (= 1,1-dimethylethyl hydroperoxide)		O.1
	Carbon tetrachloride	refer to: tetrachloromethane	O.1
1,2,3,4-	Tetrabromomethane		O.1
1,1,2,2-	Tetrachloroethane		O.1
	Carbon tetrachloride	refer to: tetrachloromethane	O.1
	Tetrachloromethane	3)	O.1
	Thioalcohols		O.1
	Thiobismethane	9); refer to: dimethyl-mercaptan	O.1
	Thioethers		O.1
	Tin compounds, organic	refer to: organostannic compounds	O.1
o-	Toluidine	refer to: 2-methylaniline	O.1
2,4,6-	Tribromophenol	9)	O.1
	Tribromomethane	9)	O.1
1,1,2-	Trichloroethane		O.1
	Trichlorophenols		O.1
	Trichloromethane		O.1

	Triethylamine		0.1
	Triphenylphosphate	⁹⁾	0.1
	Xylenols	with the exception of 2.4-xyleneol	0.1
	Acetonitrile		0.2
	Alcoholethylene-oxide-phosphate ester (a mixture of c ₁₂ /c ₁₄ monomers, dimers and trimers)		0.2
6-	Aminohexanoic acid (dimer)		0.2
6-	Aminohexanoic acid (monomer)		0.2
6-	Aminohexanoic acid (trimer)		0.2
i-	Amylacetate		0.2
n-	Amylacetate		0.2
	Anisol	⁹⁾ , refer to: methoxybenzene	0.2
	Acetic acid		0.2
	Acetic methylester	refer to: methylacetate	0.2
	Acetic vinyl ester	refer to: vinyl acetate	0.2
	Benzaldehyde	⁹⁾	0.2
	Benzylalcohol		0.2
	Bicyclo(4,4,0)decane	refer to: decahydro-naphthalene	0.2
	Butanal		0.2
n-	Butanol		0.2
i-	Butanol		0.2
2-	Butanol		0.2
sec-	Butanol	refer to: 2-butanol	0.2
3-	Butoxy-1-propanol		0.2
1-	Butoxy-2-ethylacetate		0.2
1-	Butoxy-2-propanol		0.2
2-	Butoxyethanol		0.2
2-(2-	Butoxy-ethoxy)-ethanol	⁹⁾	0.2
2-(2-	Butoxy-ethoxy)-ethylacetate		0.2
	Butylalcohol		0.2
n-	Butylaldehyde	refer to: butanal	0.2
	Butyldiglycol	⁹⁾ , refer to 2-(2-butoxy-ethoxy)-ethanol	0.2
	Butylglycol	refer to: butoxyethanol	0.2
	Butylglycolate	⁹⁾	0.2
	Butylglycolacetate	refer to: 1-butoxy-2-ethylacetate	0.2
	Butyl lactate		0.2
n-	Butyl methacrylate		0.2
n-	Butyraldehyde	refer to: n-butylaldehyde	0.2
2-	Chloro-1,3-butadiene		0.2
	Chlorobenzene		0.2
	Chlorobenzenes	with the exception of 1.2-dichlorobenzene	0.2
2-	Chloropropane		0.2
2-	Chloroprene	refer to: 2-chloro-1,3-butadiene	0.2
	Cumene	refer to: isopropyl benzene	0.2
	Cyclohexanol		0.2
	Cyclohexanon		0.2
	Decahydronaphthalene		0.2
	Decaline	refer to: decahydronaphthalene	0.2
	Di(2-ethylhexyl)phtalate		0.2
1,4-	Dichlorobenzene		0.2
1,1-	Dichloroethane		0.2
1,2-	Dichloropropane		0.2
	Diethanolamine	refer to: 2,2'-iminodiethanol	0.2
	Diethylbenzene (isomers: 1,2-; 1,3-; 1,4)		0.2
	Diethylcarbonate		0.2
	Diethyleneglycol butylether	⁹⁾	0.2
	Diethyleneglycol monoethylether	⁹⁾	0.2
	Diethyloxalate		0.2
1,1-	Difluoroethene		0.2
1,3-	Dihydroxybenzene	⁹⁾	0.2
	Diisobutylketon	refer to: 2,6-dimethyl-heptane-4-on	0.2
	Diisopropylbenzene(s)		0.2
N,N-	Dimethylacetamide		0.2
	Dimethylaminoethanol		0.2
2,4-	Dimethylphenol		0.2
N,N-	Dimethylformamide		0.2
2,6-	Dimethyl-heptane-4-on		0.2
	Diocetylphthalate	refer to: di(2-ethylhexyl)phtalate	0.2

	Dipropyleneglycol monomethylether		0.2
	DOP	refer to: di(2-ethylhexyl)phtalate	0.2
2-	Ethoxyethanol		0.2
2-	Ethoxyethylacetate		0.2
	Ethoxypropylacetate(s)		0.2
	Ethyl-a-hydroxypropionate		0.2
	Ethylbenzene		0.2
	Ethyldiglycol	⁹⁾ , refer to: diethyleneglycol monoethylether	0.2
	Ethyleneglycol monoethylether	refer to: 2-ethoxyethanol	0.2
	Ethyleneglycol monomethylether	refer to: 2-methoxyethanol	0.2
	Ethyl lactate	refer to: ethyl-a-hydroxypropionate	0.2
	Ethyl silicate	⁹⁾	0.2
	Fenoxyethanol		0.2
	Fenoxypropanol		0.2
	Furfurylalcohol	refer to: 2-hydroxy-methylfuran	0.2
2-	Hydroxymethylfuran		0.2
2,2'-	Iminodiethanol		0.2
	Isocumol	refer to n-propylbenzene	0.2
	Isoforon	refer to 3,5,5-trimethyl-2-cyclohexene-1-on	0.2
	Iso-octyl/nonyl-phenyl- polyglycol ether (with 5 ethylene oxide units)		0.2
	Isopropenylbenzene		0.2
	Isopropylbenzene		0.2
	Carbon disulphide		0.2
	Mixture of hydrocarbons, aromatic		0.2
	Limonene		0.2
1-	Methoxy-2-propanol		0.2
1-	Methoxy-2-propylacetate	refer to methoxypropylacetate(s)	0.2
2-	Methoxyethanol		0.2
3-	Methoxyethoxyethanol		0.2
2-	Methoxypropanol		0.2
	Methoxypropylacetate(s)		0.2
2-	Methoxypropylacetate	refer to methoxypropylacetate(s)	0.2
5-	Methyl-2-hexanone	refer to: methyl-isoamylketone	0.2
1-	Methyl-3-ethylbenzene		0.2
N-	Methylacetamide		0.2
	Methylacetate		0.2
	Methylbenzene		0.2
	Methylchloroform	refer to: 1,1,1-trichloroethane	0.2
	Methylcyclohexanone		0.2
	Methylformate		0.2
	Methylglycol	refer to: 2-methoxyethanol	0.2
	Methylisoamylketone	refer to: 5-methyl-2-hexanone	0.2
a-	Methylstyrene	refer to: isopropenylbenzene	0.2
	Methyl-tertiary-butylether (MTBE)	⁹⁾	0.2
	Formic methylester	refer to: methylformate	0.2
	Monoethylether acetate		0.2
1,2-	Pentanediol	⁹⁾	0.2
	Perchloroethylene	refer to: tetrachloroethylene	0.2
	Perchloroethylene	refer to: tetrachloroethylene	0.2
	Vegetable oil, sulphated		0.2
1,2-	Propanediol	⁴⁾	0.2
	Propanoic acid		0.2
	Propanal		0.2
	Propionaldehyde	refer to: propanal	0.2
	Propionic acid	refer to: propanoic acid	0.2
n-	Propylacetate		0.2
n-	Propylbenzene		0.2
	Propyleneglycol	⁴⁾ refer to: 1,2-propanediol	0.2
	Resorcinol	⁹⁾ ; refer to: 1,3 dihydroxybenzene	0.2
	Castor oil ethoxylate (with 15 ethylene oxide units)		0.2
	Sorbitolhexaoleate, ethoxylated	⁹⁾	0.2
	Styrene	⁹⁾	0.2
	Tetrachloroethylene		0.2
	Tetraethyl orthosilicate		0.2
	Tetrahydrofuran		0.2
1,2,3,4-	Tetrahydronaphthalene		0.2
	Tetraline	refer to: 1,2,3,4-tetrahydronaphthalene	0.2

1,2,3,4-	Tetramethyl benzene		0.2
1,2,3,5-	Tetramethyl benzene		0.2
1,2,4,5-	Tetramethyl benzene		0.2
	Toluene	refer to: methylbenzene	0.2
	Trichloroethylene	refer to: trichloroethylene	0.2
1,1,1-	Trichloroethane	3)	0.2
	Trichloroethylene		0.2
	Triethanolamine		0.2
	Triethylene tetramine		0.2
	Trimethyl benzene		0.2
	Vinyl acetate		0.2
	Vinyl benzene		0.2
	Vinylidene fluoride	refer to 1.1-difluoroethene	0.2
	Xylenes		0.2
2,4-	Xylenol	refer to: 2,4-dimethylphenol	0.2
	Carbon disulphide	refer to: carbon disulphide	0.2
	Petroleum		0.3
	Acetone	refer to: propanone	0.3
	Acetylene	refer to: ethyn	0.3
	Alkylalcohols		0.3
	Acetic butylester	refer to: n-butylacetate	0.3
	Acetic ester		0.3
	Acetic ethylester	refer to: ethylacetate	0.3
	Petrol (benzine)		0.3
1-	Bromobutane		0.3
	Bromochloromethane	9)	0.3
1-	Bromopropane		0.3
tert-	Butanol	refer to: 2-methyl-2-propanol	0.3
2-	Butanone		0.3
iso-	Butylacetate		0.3
n-	Butylacetate		0.3
	Butylstearate	9)	0.3
	Chloroethane		0.3
	Cyclohexane	refer to: hydrocarbons, paraffinic	0.3
	Decamethylcyclopentasiloxane(d5)	9)	0.3
	Diacetone alcohol	refer to: 4-hydroxy-4-methyl-2-pentanone	0.3
	Dibutyl ether		0.3
2,2-	Dichloro-1,1,1-trifluoroethane		0.3
1,2-	Dichloro-1,1,2-trifluoroethane		0.3
1,2-	Dichloroethylene		0.3
	Dichloromethane		0.3
	Didodecylmaleate		0.3
	Diethyl ether		0.3
	Diisobutene	refer to: 2,4,4-trimethyl-1-pentene	0.3
	Diisopropyl ether	refer to: 2-iso-propoxypropane	0.3
2,3-	Dimethyl butane		0.3
	Dimethyl ether		0.3
1,2-	Ethanediol		0.3
	Ethanol		0.3
	Ethanolamine		0.3
	Ethylene		0.3
	Ether	refer to: diethyl ether	0.3
	Ethylacetate		0.3
	Ethylchloride	refer to: chloroethane	0.3
	Ethyleneglycol	refer to: 1.2-ethanediol	0.3
	Ethylformate		0.3
	Ethylmethylketone	refer to: 2-butanone	0.3
	Ethyn		0.3
	Glycerol	9)	0.3
	Glycol	refer to: 1.2-ethanediol	0.3
	Hexafluoroethane	9)	0.3
	Hexamethylcyclotrisiloxane(d3)	9)	0.3
4-	Hydroxy-4-methyl-2-pentanone		0.3
	Isobutanol-2-amine		0.3
	Isobutene	refer to 2-methylpropene	0.3
	Isobutylene	refer to 2-methylpropene	0.3
	Isobutylmethylketone	refer to: 4-methyl-2-pentanone	0.3
	Isobutylstearate	9)	0.3
	Iso-decanol		0.3

	Iso-propanol	9)	O.3
2-	Isopropoxypropane		O.3
	Isopropyl acetate		O.3
	Potassium oleate		O.3
	Carbon tetrafluoride	9)	O.3
	Hydrocarbons, paraffinic		O.3
	Hydrocarbons, olefinic		O.3
	Mixture of hydrocarbons, aliphatic		O.3
	MEK	refer to: 2-butanone	O.3
	Methanol		O.3
3-	Methyl-2-butanone		O.3
4-	Methyl-2-pentanone		O.3
2-	Methyl-2-propanol	refer to alkylalcohols	O.3
	Methylcyclohexane	refer to: hydrocarbons, paraffinic	O.3
	Methylene chloride	refer to: dichloromethane	O.3
	Methylethylketone	refer to: 2-butanone	O.3
	Methylisobutylketone	refer to: 4-methyl-2-pentanone	O.3
	Methylisopropylketone	refer to: 3-methyl-3-butanone	O.3
2-	Methylpropene		O.3
	Methylpropylketone	refer to: 2-pentanone	O.3
n-	Methylpyrrolidone		O.3
	MIBK	refer to: 4-methyl-2-pentanone	O.3
	Octafluoropropane	9)	O.3
	Octamethylcyclotetrasiloxane(d4)	9)	O.3
	Liquid paraffin		O.3
	Pentane	refer to: hydrocarbon mixture, aliphatic	O.3
	Penta-erythritol and c9-c10 fatty acid, ester of		O.3
2-	Pentanone		O.3
3-	Pentanone		O.3
	Pinenes		O.3
2-	Propanol	9); refer to: alkylalcohols	O.3
	Propanone		O.3
n-	Propenol		O.3
i-	Propylacetate		O.3
	Silicone oil		O.3
a-	Terpinol		O.3
	Tetrafluoromethane	9)	O.3
	Tridecanol (mixture of isomers)		O.3
	Tridecyl alcohol		O.3
	Trifluoromethane	9)	O.3
2,4,4-	Trimethyl-1-pentene		O.3
	Trimethylbromate	9)	O.3
	White spirit	refer to: hydrocarbon mixture, aliphatic	O.3

⁹⁾ For CAS numbers refer to Appendix 4.5

²⁾ In TA-luft this substance is classified as C.2, but due to EC classification it has been classified as non-carcinogenic

³⁾ Refer also to: Decree concerning Substances which harm the ozone layer (Statute Book 1992, 559), amendment thereof (Statute Book 1994, 149)

⁴⁾ In TA-luft this substance has been classified as O.3.

⁹⁾ Provisional classification

Classification of organic substances

This list has been compiled by complementing the list in TA-luft with those substances for which, according to the Emission Registration to Air (ER-L), the emission to the atmosphere exceeds 1000 kg per year.

As these substances have not been individually classified for the NeR (yet), for the time being only those substances have been included which already had received a classification in TA-luft, with the exception of petroleum, petrol (benzine) and aliphatic mixtures of hydrocarbons (all of which have been classified as O.3) and mixtures of aromatic of hydrocarbons (classified as O.2 on the basis of their benzene content).

The classification of new organic substances will in principle be undertaken according to the following flowchart.

Figure 1 Flowchart for the classification of organic substances

Comments on the terms used in the flowchart

(Likely) carcinogenic:

refer to §3.2.2

MAC:

Although the MAC value is also determined on other grounds than health effects, the MAC value is still a key parameter for the time being in assessing the degree of harmfulness to the environment.

The following classification can be utilized:

class	toxicity	MAC value (mg/m ³)
O.1	high	<25
O.2	medium	≥25 and <500
O.3	limited	≥500

For the classification of organic substances for which no MAC value has been established, please refer to InfoMil for the time being.

Very toxic, persistent and with a tendency to accumulate:

Organic substances with an extremely high risk for man and the environment are classified, on the grounds of their toxicity, persistence and tendency to accumulate, in the group 'Extremely Hazardous Substances'. Examples of such substances are dioxins and PCBs.

Accumulation:

If the logarithm of the distribution coefficient between n-octanol and water, $\log(P_{o,w})$, is 2.7 or more the possibility of biological accumulation is considered as 'high'.

Persistence:

In order to assess the persistence of a substance it is necessary to first know the distribution of the substance being emitted and possibly of its reaction products over the three compartments air, water and soil. This distribution can be estimated using the so-called Mackay model (ref.: Mackay, P., and S. Paterson: Calculating fugacity. Environ.Sci.Technol. 15 (1981) S. 1006/1014).

If the substance in question occurs in significant quantities in a certain environmental compartment, i.e. > 10 % of the total, then any possibilities of substances being broken down in that compartment are taken into consideration. The decomposition of a substance in air will mainly occur through chemical/physical (abiotic) processes, and in water and soil mainly by biological activity.

For the compartment air a substance is considered as persistent if the half life exceeds 10 days ($t_{1/2} > 10$ days).

For the compartment water and soil a substance is considered as of limited degradability if this has been found during a suitable 'Grundstufentest' in accordance with Annex V of EC Directive 79/831/EWG.

Particulate organic substances

Class sO.1

In the case of an untreated mass flow of 0.10 kilograms per hour or more of substances from Class sO.1 the possibility of achieving a residual emission lower than 10 mg/m_0^3 (for example, by using filtering separators) must be seriously studied. If this is not possible then an emission standard applies of 25 mg/m_0^3 maximum.

In situations characterised by an untreated mass flow below the limit mass flow, an emission standard applies of 50 mg/m_0^3 maximum and in the case where filtering separators are used, of 10 mg_0^3 .

Classes sO.2 and sO.3

The emission standards of Class S are applicable to emissions of particulate organic substances belonging to the classes O.2 or O.3 (refer also to §3.2.3.)

	Name of substance	Remarks	Class
	Anthracene		sO.1
	Biphenyl		sO.1
	Diphenyl	refer to: biphenyl	sO.1
	Diphenyl ether		sO.1
	Diphenylmethane-2,4-di-isocyanate		sO.1
	Phthalic anhydride		sO.1
	MAA	refer to: maleic anhydride	sO.1
	Maleic anhydride		sO.1
	MDI	refer to: diphenylmethane-2,4-diisocyanate	sO.1
1-	Methyl-2,4-phenylene-diisocyanate		sO.1
1-	Methyl-2,6-phenylene-diisocyanate		sO.1
	Nitro-cresols		sO.1
	Nitrophenols		sO.1
	Nitrotoluene(s)		sO.1
	TDI	refer to: 2-methyl-1,4-phenylene-diisocyanate	sO.1
	Toluene-2,4-diisocyanate	refer to: 1-methyl-2,4-phenylene-diisocyanate	sO.1
	Toluene-2,6-diisocyanate	refer to: 1-methyl-2,6-phenylene-diisocyanate	sO.1
	Naphthalene		sO.2
	Naphthaline	refer to: naphthalene	sO.2
	Polyethylene glycol	⁹⁾	sO.2
	Benzoic methyl ester	refer to: methyl benzoate	sO.3
	Methyl benzoate		sO.3

^{*)} For CAS numbers refer to Appendix 4.5.

⁹⁾ Provisional classification.

B. UK categorisation of Volatile Organic Compounds

Introduction: Volatile organic compounds (VOCs) are of serious environmental concern because of the harmful or offensive properties which they exhibit in varying degrees. These include:

- direct toxicity to human health and other eco-systems;
- contribution to photochemical ozone creation at ground level with consequent harmful effects;
- destruction of stratospheric ozone;
- contribution to global climate change;
- sensory effects such as malodour.

The harmfulness of VOCs varies greatly, not only because the individual and combined significance of these properties exhibits wide variation between substances, but also because it is dependent on the presence of the substance in the environment. This is related to mass release rate and subsequent dispersion and to the environmental persistence and fate of the substance under prevailing conditions.

Categorisation: In order to assess applications for processes which release VOCs, it is necessary to categorise VOCs according to their harmfulness.

Substances such as benzene, vinyl chloride and 1,2 dichloroethane pose serious health risks to humans and are regarded as highly harmful. These are given individual, very low achievable levels of emission in guidance.

Some other VOCs carry a lesser but still significant health risk or may contribute substantially to photochemical ozone creation or stratospheric ozone destruction or global warming. These are regarded as of medium harmfulness and are allocated to Class A. They will include the substances listed in the Montreal Protocol⁽¹⁾, the phase-out of which is covered by EC Regulations 594/91, 3952/92, 2047/93 and 3093/94.

The remaining majority of VOCs are of low harmfulness but are also prescribed substances whose release must be prevented or minimised. These are allocated to Class B.

Odoriferous VOCs may be offensive at extremely low concentrations and this property may indicate the need for very tight control of a substance which would otherwise be categorised as of low harmfulness.

The research report 'The Categorisation of Volatile Organic Compounds' (DOE/HMIP/RR/95/009)⁽²⁾ provides a method of categorisation, information on the properties of some 500 VOCs and a summary table of resulting categorisations (Table F1).

In seeking to categorise a VOC, Inspectors should first search the summary table of categorisations. If the VOC is not included, the method and decision tree (Figure 1) given in the research report should be used to arrive at a conclusion supported as well as possible by information from established sources. These include the Registry of Toxic Effects of Chemicals⁽³⁾, the 'CHIP' list⁽⁴⁾, the Montreal Protocol⁽¹⁾ and Sax's Dangerous Properties of Industrial Materials⁽⁵⁾.

Knowledge of the harmful effects of VOCs is developing and there may be occasional differences of experts' opinions on the precise interpretation of information. In these few instances, it will be prudent to adopt the more cautious view.

Achievable Benchmark Levels: The levels of emission which can be achieved are dependent on factors which include the prescribed process itself, the VOC concerned and the abatement method used. Before abatement equipment is considered, the operator should review the process to

determine whether the emission can be reduced by changes in equipment or operating conditions. It may also be possible to substitute with a less harmful or less volatile compound.

Where possible, process and substance specific achievable levels of release are given in process guidance.

An environmental assessment should be made wherever possible to determine an acceptable release level. However, in the absence of sufficient information or where it is agreed by the Inspector that an assessment is not possible, the following guidelines may be used to provide a practical approach to setting limits. Inspectors should also consider all relevant information contained in applications and other appropriate sources when they set VOC emission concentration or mass limits in authorisations.

- 1) The benchmark release concentrations given below should be aimed for where the following mass release limits are exceeded:

Total Class A	100 g/h
Total Class B (expressed as toluene)	2 kg/h

Releases below these mass emission levels may not be trivial, and so may still require controls and the setting of appropriate release limits.

- 2) Highly harmful VOCs pose major human health risks and have individual guidance levels given in process guidance..
- 3) For Class A compounds, state of the art abatement techniques can achieve a benchmark release level of 20 mg/m³ for continuous releases. Her Majesty's Inspectorate of Pollution published two Technical Guidance Notes and a research report on pollution abatement technology^(6,7,8) which give relevant information on such techniques.
- 4) Some VOCs cause significant malodour problems even at very low concentrations after dispersion and limits lower than Class A compounds may be required.
- 5) Class B compounds are those of low environmental harmfulness such as acetone and toluene. Toluene has been used as a reference material as it is a common Class B solvent. If levels were expressed as total organic carbon (TOC), the mass concentration limit, particularly for halogenated compounds, would be too lax as the compound may have a high molecular weight relative to its number of carbon atoms.

The Class B benchmark level has been set at 80 mg/m³ toluene based on abatement techniques involving adsorption with activated carbon.

The benchmark release level for a Class B substance may be determined by multiplying the molecular weight of the pollutant by a factor of 0.87 to give the release level in mg/m³. For mixed streams the release level may be calculated by summing the class limits multiplied by their respective mass fractions.

- 6) The above is for guidance on setting release levels only and not for monitoring those releases. Monitoring would be expected to be for individual substance or for TOC. HMIP Technical Guidance Note M2⁽⁹⁾ gives more information on monitoring techniques.
- 7) The use of a release concentration limit is not normally appropriate in the case of a release from an air-deficient saturated vapour space such as storage tanks for solvents or process vessels. An approach based on limiting total mass released or mass per unit of production is likely to be more effective.

- 8) In some processes, the VOCs released to air may well consist of partial oxidation products rather than defined compounds which can be classified as above. In such cases an approach based on a TOC release concentration is likely to be more effective. Reference may be made to relevant Guidance Notes for Waste Disposal and Recycling and the release emission concentrations used should take into account the harmfulness of the products which are released.

REFERENCES

1. *Montreal Protocol on Substances that Deplete the Ozone Layer* - CM 283. (HMSO) ISBN 0-10-102832-6
2. *The Categorisation of Volatile Organic Compounds*. DOE/HMIP/RR/95/009
3. *Registry of Toxic Effects of Chemical Substances*. Canadian Centre for Occupational Health and Safety
4. *CHIP - The Chemicals (Hazard Information and Packaging) Regulations Approved Supply List*. (HMSO) ISBN 0-11-882156-3
5. *Sax's Dangerous Properties of Industrial Materials*. Van Nostrand Reinhold
6. *Pollution Abatement Technology for the Reduction of Solvent Vapour Emissions*. HMIP Technical Guidance Note (Abatement) A2. (HMSO) March 1994 ISBN 0-11-752925-7
7. *Pollution Abatement Technology for Particulate and Trace Gas Removal*. HMIP Technical Guidance Note (Abatement) A3. (HMSO) April 1994, ISBN 0-11-752983-4
8. *Techniques for the Control of Volatile Organic Compounds*. DOE Research Report No. DOE/HMIP/RR/95/034
9. *Monitoring Emissions of Pollutants at Source*. HMIP Technical Guidance Note (Monitoring) M2. (HMSO) January 1994 ISBN 0-11-752922-2

FIGURE 1: The categorisation decision tree for VOCs.

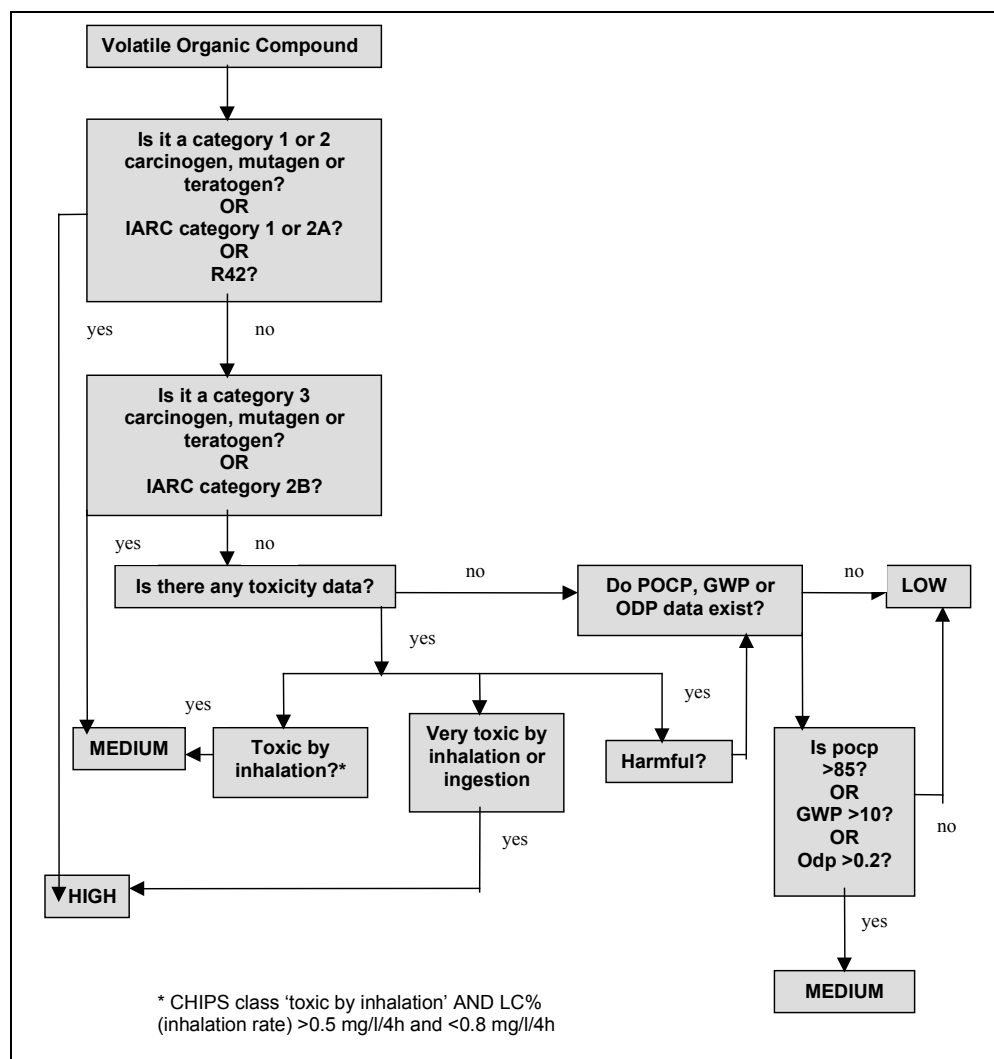

Table F1 Categorised list of VOCs

Footnotes are printed after the table

Substance Name	CAS No._	Toxicity	POCP ¹	ODP ²	GWP ³	Odour ⁴	Category
Acetaldehyde (ethanal)	75-07-0	Cat. 3 Carcinogen	65			0.066	medium
acetate esters		-					low
acetic acid (ethanoic acid)	64-19-7	Harmful	16			0.016	low
acetic anhydride	108-24-7	Harmful				0.00029	low
acetone (propanone)	67-64-1	Unclassified	18			4.58	low
acetonitrile	75-05-8	Toxic				1.96	medium
acetyl acetone	123-54-6	Toxic					low
acetyl chloride	75-36-5	Harmful					low
acetylene (ethyne)	74-86-2	Unclassified	28			620	low
acrylamide	79-06-1	Cat. 2 Carcinogen and Mutagen					high
acrylates - total not otherwise specified		-					low
acrylic acid	79-10-7	Toxic (Ingestion); Categorised on inhalation data				0.0004	low
acrylonitrile	107-13-1	Cat. 2 Carcinogen				1.96	high
adipic acid	124-04-9	Irritant					low
alcohols		-					low
aldehydes		-					low
aldrin	309-00-2	Cat. 3 Carcinogen ⁵					medium
amines		-					low
2-aminoethanol (monoethanolamine)	141-43-5	Harmful				2.6	low
2-(2-aminoethylamino)ethanol		-					low
2-amino-2-methyl propanol	124-68-5	Irritant					low
amitrole (aminotriazole)	61-82-5	Cat. 3 Carcinogen ⁵					medium
ammonium pentadecafluorooctanoate	3825-26-1	Toxic (Inhalation)					low
amyl alcohol	71-41-0	Unclassified				0.0051	low
aniline	62-53-3	Cat. 3 Carcinogen				0.2	medium
anthracene	120-12-7	Unclassified					low
anthraquinone	84-65-1	Toxic (Inhalation) ⁵					low
L-aspartic acid (including z-blocked)	86-84-4	-					low
atrazine	1912-24-9	Cat. 3 Carcinogen and Mutagen ⁵					medium
azinphos-methyl	86-50-0	Very Toxic ⁵					high
benzaldehyde	100-52-7	Toxic; categorised by inhalation data	-6			2 x 10 ⁻⁶ to 3 x 10 ⁻⁵	medium
benzamide	55-21-0	Unclassified					low
benzene	71-43-2	Cat. 1 Carcinogen	33			8.65	high
benzene-1,2,4-tricarboxylic acid 1,2-anhydride	552-30-7	R42					high
benzo (a) anthracene	56-55-3	Cat. 2 Carcinogen					high
benzo (a) fluorene	238-84-6	Unclassified					low
benzo (b) fluorene	30777-19-6	-					low
benzo (b) fluoranthene	205-99-2	Cat. 2 Carcinogen					high
benzo (k) fluoranthene	207-08-9	Cat. 2 Carcinogen					high
benzo (j) fluoranthene	205-82-3	Cat 2 Carcinogen					high

benzo (g,h,i) perylene	191-24-2	Unclassified					low
benzo (a) pyrene	50-32-8	Cat 2 Carcinogen, Mutagen and Teratogen					high
benzo (e) pyrene	192-97-2	Unclassified					low
p-benzoquinone (quinone, benzoquinone)	106-51-4	Toxic (ingestion); no inhalation data					low
1,2-benzo iso thiazol- 3(2h)-one	2634-33-5	-					low
benzyl alcohol	100-51-6	Harmful					low
benzyl chloride	100-44-7	Cat. 3 Carcinogen				0.045-1.5	medium
benzyl chloride	see chlorotoluene						
benzyl-dimethylamine	103-83-3	Harmful					low
biocides - total not otherwise specified		- ⁵					low
bis(2- hydroxyethyl)ether (1,1- oxydiethanol)	111-46-6	Unclassified					low
bisol k		-					low
bromoethane	74-96-4	Toxic					medium
4-bromophenyl acetate		-					low
1-bromopropane	106-94-5	Harmful					low
2-bromopropane	75-26-3	Unclassified					low
3-bromopropene	106-95-6	Toxic (Ingestion); Categorised on inhalation data					low
butadiene	106-99-0	Cat. 2 Carcinogen				0.45	high
butane	106-97-8	Unclassified	60			2100	low
i-butane	75-28-5	-	43				low
butanethiols	109-79-5	Harmful				0.000348	low
n-butanol	71-36-3	Harmful	63			0.04	low
2-butanol	see sec-butyl alcohol						
2-butanone (methyl ethyl ketone)	78-93-3	Irritant	51			0.27	low
2-butanone oxime (methyl ethyl ketoxime)	96-29-7	Harmful					low
1-butene	106-98-9	Unclassified	113				medium
(e)-2-butene	624-64-6	-	99			810	medium
(z)-2-butene	590-18-1	-	99			810	medium
butenes	107-01-7	Unclassified					medium ⁶
2-(2-butoxyethoxy)ethyl acetate	124-17-4	Unclassified				0.016	low
2-butoxyethyl acetate	112-07-2	Harmful				0.0063	low
butyl acetate	123-86-4	Unclassified	51			0.0066	low
i-butyl acetate	540-88-5	-				0.0066	low
n-butyl acetate	see butyl acetate						
n-butyl acrylate	141-32-2	Harmful				0.18	low
sec-butyl alcohol	78-92-2	Harmful				7.8	low
butylamine	109-73-9	Harmful				0.24-219	low
tert-butylamine		Toxic (Ingestion); Categorised on inhalation data				0.08	low
butylcyclohexanes	1678-93- 9/3178-22-1	-					low
1,3-butylene-glycol	107-88-0	Unclassified					low
1,3-butylene glycol diacrylate	19485-03-1	Harmful					low
butyl glycol	11-76-2	Harmful	63				low
butyl glycol acetate	112-07-2	Harmful					low
butyl glycolate		-					low

butyl lactate	138-22-7	Unclassified				7	low
butyl propionate	590-01-2	Unclassified					low
2-butylthiophene		-					low
i-butyraldehyde (2-methylpropanal)	78-84-2	Harmful	86				medium
butyrolactone(gamma)	96-48-0	Harmful					low
C ₉ + alkanes		-					low
C ₆ alkenes		-					low
C ₇ alkenes		-					low
C ₈ alkenes		-					low
C ₉ alkenes		-					low
C ₃ alkylbenzenes		-					low
C ₃ , C ₄ & C ₅ alkylbenzenes		-					low
C ₁₀ aromatic		-					low
C ₈ H ₁₀ aromatic		-					low
C ₉ H ₁₂ aromatic		-					low
C ₁₀ H ₁₄ aromatic		-					low
C ₇ cycloparaffins		-					low
C ₈ cycloparaffins		-					low
C ₁₂ H ₂₆ branched hydrocarbon		-					low
C ₁₃ hydrocarbons		-					low
C ₂ & up substituted benzene		-					low
camphor/fenchone	464-49-3/76-22-2	-				0.27	low
carbon disulphide	75-15-0	Cat. 2 Teratogen				0.11	high
carbon tetrachloride	56-23-5	Cat. 3 Carcinogen		1.20	1400	40.73	medium
carbonyl sulphide	463-58-1	-				0.012	low
carboxylic acids	68937-68-8/68603-84-9	-					low
chlorobenzene (monochlorobenzene)	108-90-7	Harmful				0.042	low
chlorobromo propane	109-70-6	Harmful					low
chlorodifluoromethane (HCFC 22)	75-45-6	-		0.04	1700		medium
1-chloro-2,3-epoxypropane (epichlorohydrin)	106-89-8	Cat. 2 Carcinogen				0.93	high
chloroethane (ethyl chloride)	75-00-3	Unclassified				4.2	low
chloroethene (chloroethylene, vinyl chloride)	75-01-4	Cat. 1 Carcinogen	27			190	high
chlorofluorocarbons		-			6000		medium
chlorofluoromethane	593-70-4	-					low
chloroform (trichloromethane)	67-66-3	Cat 3 Carcinogen			5	85	medium
chloromethane	74-87-3	Cat 3 Carcinogen		0.02			medium
N-(3-chloro-4-methoxyphenyl)-N, N-dimethylurea	96-31-1	-					low
(chloromethyl) ethylbenzene	30030-25-2	-					low
1-chloro-2-nitrobenzene (o-chloronitrobenzene)	88-73-3	Harmful					low
1-chloro-3-nitrobenzene (m-chloronitrobenzene)	121-73-3	Harmful					low
1-chloro-4-nitrobenzene (p-chloronitrobenzene)	100-00-5	Toxic					low
chlorophenols	95-57-8/108-43-0/106-48-9	Harmful				0.3	low
chloropropanes	26446-76-4	Unclassified					low

m-chlorotoluene	108-41-8	Harmful					low
o-chlorotoluene	95-49-8	Harmful					low
p-chlorotoluene	106-43-4	ful					low
chrysene	218-01-9	Unclassified					low
cresol - all isomers	108-39-4/95-48-7/106-44-5	Toxic (Ingestion); Categorised on inhalation data				0.00047	low
cumene	98-82-8	Harmful				0.008	low
cyanamide	156-62-7	Very Toxic (Inhalation) ⁵					high
cyanamide (ACGIH, OSHA)	420-04-2	Very Toxic ⁵					high
cyclohexane	110-82-7	Unclassified	60			83.8	low
cyclohexanol	108-93-0	Harmful	62			0.15	low
cyclohexanone	108-94-1	Harmful	53			3.53	low
1,3 cyclohexanone	504-02-9	Unclassified				0.083	low
cyclopentane	287-92-3	-					low
cyclopentene	142-29-0	Harmful					low
ddt - all isomers (1,1,1- trichloro-2,2-bis(p- chlorophenyl) ethane)	50-29-3	Cat.3 Carcinogen ⁵					medium
decane	124-18-5	-	68				low
decane isomers		-					low
2-decanone	693-54-9	-					low
1-decene	872-05-9	-					low
decenes	-	-				7	low
diallate	2303-16-4	Cat. 3 Carcinogen ⁵					medium
diallyl maleate	999-21-3	Harmful					low
1,2-diaminoethane (ethylenediamine)	107-15-3	Harmful				1	low
dibenzo (a,h) anthracene	53-70-3	Cat. 2 Carcinogen					high
dibenzo (a,e) pyrene	192-65-4	IARC Gp 2B					medium
dibenzo (a, h) pyrene	189-64-0	IARC Gp 2B					medium
dibenzo (a, i) pyrene	189-55-9	IARC Gp 2B					medium
1,1-dibromoethane	74-95-3	-					low
2,4-dibromophenyl acetate		-					low
dibutyl maleate	015-76-0	Unclassified					low
dibutyl phthalate	84-74-2	Harmful ⁵					low
1,2-dichlorobenzene	95-50-1	Harmful				0.64	low
1,3-dichlorobenzene	541-73-1	Harmful					low
1,4-dichlorobenzene	106-46-7	IARC Gp 2B					medium
dichlorobutenes		Unclassified					low
dichlorodifluoromethane (CFC-12)	75-71-8	-		0.82	8500		medium
1,1-dichloroethane (ethylidene dichloride)	75-34-3	Harmful					low
1,1-dichloroethene (vinylidene chloride)	75-35-4	Toxic				0.003	low
1,2-dichloroethane (ethylene dichloride)	107-06-2	Cat. 2 Carcinogen				0.0033	high
1,2-dichloroethenes	540-59-0/156-60-5	Harmful				0.0033	low
dichlorofluoromethane	75-43-4	-					low
1,6-dichlorohexane (dichlorohexane)	2163-00-0	-					low
dichloromethane (methylene chloride or dichloride)	75-09-2	Cat. 3 Carcinogen	3		9	0.912	medium
1,1-	374-07-2	-		~0.85			medium

dichlorotetrafluoroethane (CFC 114a)							
1,2-dichlorotetrafluoroethane (CFC 114)	76-14-2	-		0.85	9300		medium
dichlorvos	62-73-7	Very Toxic ⁵					high
dicyandiamide	461-58-5	Unclassified					low
1,6-dicyanohexane (dicyanohexane)	629-40-3	Harmful					low
dieldrin	60-57-1	Very Toxic ⁵					high
diethanolamine	see 2,2'-iminodiethanol						
diethylamine	109-89-7	Harmful				5.16	low
N,N-diethylaniline	91-66-7	Toxic; categorised by inhalation data					low
2,6-diethylaniline	579-66-8	Harmful					low
3,4-diethylaniline	54675-14-8	Unclassified					low
diethyl disulphide	110-81-6	-					low
diethylene triamine	see 2,2'-iminodi(ethylamine)						
diethyl ether	60-29-7	Harmful					low
diethyl oxalate	95-92-1	Harmful					low
diethyl sulphate	64-67-5	Cat. 2 Carcinogen and Mutagen					high
difluoromethane	75-10-5	-			580		medium
di-iso-amylene		Unclassified					low
di-iso-butylene	107-40-4	Unclassified					low
diisopropyl ether	108-20-3	Unclassified				0.07	low
dimethylamine	124-40-3	Harmful				0.047	low
1,1'-dimethyl-4,4'-bipyridinium (paraquat)	4685-14-7	Toxic (ingestion); no inhalation data ⁵					low
2,2-dimethylbutane	79-29-8	-	32				low
dimethyl disulphide	624-92-0	Very Toxic					high
dimethyl esters		-					low
dimethyl ether	115-10-6	Unclassified	26			2	low
dimethylformamide	68-12-2	IARC Gp 2B				2.2	medium
2,5-dimethylhexane		-					low
dimethyl isobutyl ketone		Unclassified					low
2,2-dimethyl-3-methylbutane		-					low
3,3-dimethylpentane		-					low
2,2-dimethylpropane	463-82-1	Unclassified					low
N,N-dimethylpyridin-4-amine	1558-17-4	-					low
dimethyl sulphate	77-78-1	Cat. 2 Carcinogen					high
dimethyl sulphide	75-18-3	Unclassified				0.00033	low
dimethyl-o-toluidine	609-72-3	Unclassified					low
dimethyl-p-toluidine	99-97-8	Unclassified					low
dimethyl trisulphide	3658-80-8	-					low
dinoseb	88-85-7	Cat. 2 Teratogen ⁵					high
4,8-dioxa-1-dodecanol	112-59-4	Harmful					low
1,4 dioxane	123-91-1	Cat 3 Carcinogen				3.0	medium
1,3-dioxolane	646-06-0	Unclassified					low
dipentene	see 1,8-p-menthadiene						
dipropylene glycol	110-98-5	Unclassified					low
dipropyl ethers		-					low
diquat dibromide (diquat)	2764-72-9	Toxic (Ingestion); Categorised on inhalation data ⁵					low
dithiocarbamates - total		- ⁵					low

not otherwise specified							
dodecane	112-40-3	-	58				low
endosulfan	115-29-7	Very Toxic ⁵					high
endrin	72-20-8	Very Toxic ⁵					high
1,2-epoxypropane (methyloxirane)	see propylene oxide						
esters		-					low
ethane	74-84-0	-	14			120000	low
ethane-1,2-diol (ethylene glycol)	107-21-1	Harmful					low
1,2-ethanediol diacetate	111-55-7	-					low
ethanethiol	75-08-1	Harmful				0.000238	low
ethanoic acid	see acetic acid						
ethanol	64-17-5	Unclassified	45			0.136	low
ethofumesate	26225-79-6	Harmful ⁵					low
2-ethoxyethanol	110-80-5	Cat. 2 Teratogen				2.7	high
2-(2-ethoxyethoxy)ethanol	111-90-0	Unclassified					low
2-(2-ethoxyethoxy)ethyl acetate	112-15-2	Unclassified					low
ethoxy ethyl acetate	111-15-9	Toxic; categorised by inhalation data				0.3	low
2-ethoxyethyl acetate	115-15-9	Cat. 2 Teratogen				0.056	high
1-ethoxy-2-propanol	1569-02-4	Unclassified				0.035	low
ethoxy propyl acetate	54839-24-6	Unclassified					low
1-ethoxy-2-propyl acetate		-				0.0008	low
ethyl acetate	141-78-6	Unclassified	33			0.61	low
ethyl acrylate	140-88-5	IARC Gp 2B				0.0002	medium
ethylamine	75-04-7	Irritant				0.27	low
ethylbenzene	100-41-4	Harmful	81			2.3	low
ethyl chloride	see chloroethane						
ethylene	74-85-1	Unclassified	100			260	medium
ethylenediamine	see 1,2-diaminoethane						
ethylene dichloride	see 1,2-dichloroethane						
ethylene glycol	see ethane-1,2-diol						
ethylene oxide	75-21-8	Cat. 2 Carcinogen and Mutagen				260	high
ethyl formate	109-94-4	Harmful				31	low
2-ethyl hexane-1,3-diol	94-96-2	Harmful ⁵					low
2-ethyl hexanol	104-76-7	Harmful					low
2-ethyl hexyl acrylate	103-11-7	Irritant				0.6	low
ethyl mercaptan	see ethanethiol						
ethyl methyl ether	see methyl ethyl ether						
3-ethyl toluene or m-ethyl toluene	620-14-4	Unclassified	99				medium
2-ethyl toluene or o-ethyl toluene	611-14-3	Unclassified	85				low
4-ethyl toluene or p-ethyl toluene	622-96-8	Unclassified	94				medium
fenitrothion	122-14-5	- ⁵					low
fentin hydroxide (triphenyl tin oxide)	76-87-9	- ⁵					low
finasteride ('proscar') - (prescription drug)		-					low
fluoranthrene	206-44-0	Unclassified					low
formaldehyde	50-00-0	Cat. 3 Carcinogen ⁵	55			0.2	medium
formanilide	103-70-8	-					low
formic acid	64-18-6	Harmful				49	low

freon r502	39432-81-0	-					low
fumaric acid	110-17-8	Irritant					low
galaxolide		-					low
glycerol	56-81-5	Unclassified					low
glycidyl acrylate	106-90-1	Toxic					low
glycol	see ethane-1,2-diol						
glyoxal	107-22-2	Harmful					low
halons - total not otherwise specified		-		~5 to ~12			medium
heptadienes		-				9	low
heptanal	111-71-7	Unclassified				0.003	low
heptane	142-82-5	-	77			150	low
heptane (other isomers)		-					low
1-heptene	592-76-7	-					low
3-heptene	14686-14-7	-					low
heptenes		-					low
hexachlorobenzene	118-74-1	Cat. 2 Carcinogen					high
hexachlorobuta-1,3-diene (hexachlorobutadiene)	87-68-3	Toxic (ingestion); no inhalation data					low
hexachlorocyclohexane	608-73-1	Cat. 3 Carcinogen ⁵					medium
hexachlorocyclohexane - gamma isomer	58-89-9	Toxic (Ingestion); Categorised on inhalation data ⁵					low
hexafluoropropene	116-15-4	Harmful					low
hexamethyldisilane	999-97-3	Harmful					low
hexamethylenediamine	124-09-4	Harmful					low
hexanal	66-25-1	Unclassified				0.0045	low
hexane (n-hexane)	110-54-3	Harmful	65			130	low
hexane (other isomers)		-				130	low
n-hexanol	111-27-3	Harmful				0.00004	low
2-hexanol	626-93-7	Unclassified					low
1-hexene	592-41-6	-					low
(e)-2-hexene	4050-45-7	-					low
(z)-2-hexene	7688-21-3	-					low
hexenes		-					low
2-(1-hexoxy)ethanol		-					low
hexylbenzene	1077-16-3	-					low
2-hexylthiophene		-					low
hydrobromo fluorocarbons							low
hydrocarbon vapour unspec		-					low
hydrochloro fluorocarbons							low
hydroquinone	123-31-9	Harmful					low
2-hydroxyethyl acrylate	818-61-1	Toxic; categorised by inhalation data					medium
hydroxypropyl acrylate	999-61-1	Toxic					low
hydroxyl propyl methacrylate	27813-02-1	Irritant					low
2-hydroxy propyl methacrylate	923-26-2	Irritant					low
2,2'-iminodiethanol (diethanolamine)	111-42-2	Harmful				0.27	low
2,2'-iminodi(ethylamine) (diethylene triamine)	111-40-0	Harmful					low
indane	496-11-7	-					low
indeno (1,2,3-cd) pyrene	193-39-5	IARC Gp 2B					medium

industrial methylated spirits							low
iodomethane	74-88-4	Cat. 3 Carcinogen				0.005	medium
isoamyl alcohol	see 3-methylbutan-1-ol						
isobutyl alcohol	see 2-methyl-1-propanol						
isobutylene	see 2-methyl-1-propene						
isobutyric acid	79-31-2	Harmful					low
isopentane	see 2-methylbutane						
isophorone	78-59-1	Harmful				1.3-23	low
isophorone di-iso cyanate	4098-71-9	Very Toxic					high
isophthalic acid	121-91-5	Unclassified					low
isopropyl alcohol	see 2-propanol						
isopropyl ether	see diisopropyl ether						
iso-valeraldehyde (3-methylbutanal)	see 3-methylbutanal						
lauryl methacrylate	142-90-5	Unclassified					low
malathion	121-75-5	Harmful ⁵					low
maleic anhydride	108-31-6	R42				0.32	high
manganese compounds - total		-					low
1,8-p-menthadiene	138-86-3	Irritant					low
menthene	1124-27-2	-					low
mercaptans total - not otherwise specified		-					low
mesitylene (1,3,5-trimethyl benzene)	108-67-8	Irritant	130				medium
methacrylic acid (methyl methacrylate)	79-41-4	Harmful				0.083	low
methane	74-82-8	Unclassified	3		24.5 ± 7.5		medium
methanethiol	see methyl mercaptan						
methanol	67-56-1	Toxic (Ingestion); Categorised on Inhalation Data	21			4	low
1-methoxy-2-propanol	107-98-2	Unclassified				0.003	low
2-methoxy-1-propanol	1589-47-5	Unclassified					low
methoxy-1-propanol	28677-93-2	Unclassified					low
1-methoxy-2-propyl acetate	70657-70-4	-				0.0014	low
methyl acetate	79-20-9	-	5			0.21	low
methylacrylamide	79-39-0	Harmful					low
methyl acrylate	96-33-3	Harmful				0.0048	low
methylamine	74-89-5	Toxic; categorised by inhalation data				0.0012- 0.065	medium
methyl bromide	74-83-9	Harmful		0.64			medium
2-methylbutanal (2-methylbutyraldehyde)	96-17-3	Unclassified				0.0004	low
3-methylbutanal	590-86-3	Unclassified				0.0004	low
2-methylbutane (isopentane)	78-78-4	-	60				low
methyl butanoate	623-42-7	Unclassified					low
3-methylbutan-1-ol (isoamyl alcohol)	123-51-3	Harmful				0.041	low
2-methyl-1-butene	563-46-2	-	83				low
2-methyl-2-butene (amylene)	513-35-9	-	77				low
3-methyl-1-butene	563-45-1	-	118				medium
methyl chloroform	see 1,1,1-trichloroethane						
methylcyclohexane	108-87-2	-	73			630	low
methylcyclopentane	90-37-7	-					low
4-methyl-1,3-dioxol-2-	108-32-7	Unclassified					low

one							
methyl diphenyl diisocyanate		Unclassified					low
4,4'-methylenebis(2-chloroaniline)	101-14-4	Cat. 2 Carcinogen					high
methylene chloride	see dichloromethane						
4,4'-methylenedianiline (methylene dianiline)	101-77-9	IARC Gp 2B					medium
4-4'-methylenediphenyl diisocyanate	101-68-8	Very Toxic (Inhalation)					high
methyl ethyl ether	540-67-0	-					low
methyl ethyl ketone	see 2-butanone						
methyl formate	107-31-3	Unclassified				840-4916	low
methyl furans	920-27-8/534-22-5	-					low
3-methylheptane	589-81-1	-					low
methyl hexahydro phthalic anhydride	25550-51-0	Unclassified					low
2-methylhexane	591-76-4	-	72				low
3-methylhexane	589-34-4	-	73				low
5-methyl-2-hexanone	110-12-3	Unclassified					low
4-methyl-4-hydroxy-2-pentanone	123-42-2	Unclassified					low
methyl isobutyl ketone	108-10-1	Harmful	84			0.24-0.81	low
methyl isocyanate	624-83-9	Very Toxic				0.0069-0.0127-	high
methyl mercaptan	74-93-1	Toxic				0.004	low
methyl methacrylate	80-62-6	Irritant				21.03	low
8-methyl-1-nonanol		-					low
2-methylpentane	107-83-5	-	78				low
3-methylpentane	96-14-0	-	66				low
2-methyl-2,4-pentanediol	107-41-5	Irritant					low
methyl pentanoate	624-24-8	-					low
4-methyl-2-pentanol	108-11-2	Irritant					low
4-methyl-2-pentanone	see methyl isobutyl ketone						
2-methyl-1-pentene	763-29-1	Unclassified					low
2-methyl-2-pentene	625-27-4	Unclassified					low
(e)-3-methyl-2-pentene	922-62-3	-					low
2-methyl-1-propanol (isobutyl alcohol)	78-83-1	Unclassified	59			0.041	low
2-methyl-1-propene (isobutylene)	9003-27-4	-	70				low
methyl pyrrolidine	120-94-5	Unclassified					low
2-methyl pyrrolidine	765-38-8	Unclassified					low
n-methyl pyrrolidone	872-50-4	Irritant					low
methyl styrene	98-83-9/611-15-4	Irritant				0.003	low
methyl-tert-butyl ether	1634-04-4	Unclassified	27				low
morpholine	110-91-8	Harmful				0.01	low
naphthalene	91-17-8	Harmful				0.03	low
nitrobenzene	98-95-3	Very Toxic				0.018	high
nitromethane	75-52-5	Harmful					low
nitrophenols	100-02-7	Harmful					low
1-nitropropane	108-03-2	Harmful				11	low
2-nitropropane	79-46-9	Cat. 2 Carcinogen					high
nonadienes		-				11.5	low
nonane	111-84-2	-	69			65	low
1-nonene	124-11-8	-				5	low

nonenes		-				9	low
octanal	124-13-0	Unclassified				0.00136	low
octane	111-65-9	Unclassified	68			0.1	low
octane (other isomers)		-				0.1	low
organics - brominated		-					low
organics - chlorinated		-					low
organics - fluorinated		-					low
organic sulphides & mercaptan (as methyl mercaptan)		-					low
organic - tin compounds		-					low
paraquat	see 1,1'-dimethyl-4,4'-bipyridinium						
pentachlorophenol	87-86-5	IARC Gp 2B					medium
pentachlorophenol compounds		Toxic ; Categorised on inhalation data					low
pentadienes		-					low
pentanal (valeraldehyde)	110-62-3	Unclassified	89			0.0054	medium
pentane	109-66-0	Unclassified	62			400	low
pentane (other isomers)		-					low
pentanethiols	110-66-7	-					low
pentan-1-ol	see amyl alcohol						
2-pentanone	107-87-9	Harmful					low
1-pentene	109-67-1	-	104				medium
(e)-2-pentene	646-04-8	-	95				medium
(z)-2-pentene	627-20-3	-	95				medium
pentenes		-					low
i-pentyl acetate (isoamyl acetate)	123-92-2	Unclassified				0.025	low
pentyl benzene	538-68-1/29316-05-1/2049-95-8	-					low
2-pentylpyridine	2294-76-0	-					low
2-pentylthiophene	4861-58-9	-					low
perchloroethylene	see tetrachloroethene						
petrol	8002-05-9	Unclassified				L=800-33000 H=30ppm	low
petroleum ether - 'ligroline'	8032-32-4	Harmful					low
phenanthrene	85-01-8	Unclassified					low
phenol	108-95-2	Very Toxic (inhalation)				0.01	high
phenols, monohydric		-					low
phenols - not otherwise specified		-					low
phenoxyacetic acid (phenoxy acid)	122-59-8	Harmful					low
phenylacetic acid	103-82-2	Unclassified					low
2-phenylpropene (methyl styrene)	98-83-9	Irritant				0.003	low
phorate	295-02-2	Very Toxic ⁵					high
phosgene	75-44-5	Very Toxic				0.9	high
phthalic anhydride	85-44-9	Irritant				0.053	low
picric acid	88-89-1	Toxic; Categorised on inhalation data					low
pine oil	8002-09-3	Unclassified					low
polybrominated biphenyls		-					low
polybrominated naphthalenes		-					low

polybrominated terphenyls		-					low
polychlorinated biphenyls		IARC Gp 2A					high
polychlorinated dibenzo-p-dioxin - all congeners		- ⁷					high
polychlorinated dibenzofuran - all congeners		- ⁷					high
polychlorinated naphthalenes		-					low
polychlorinated terphenyls	61788-33-8/17760-93-9	-					low
polyether alcohol acetates		-					low
polyether alcohols		-					low
propanal	123-38-6	Irritant	76			0.009	low
propane	74-98-6	Unclassified	41			16000	low
1,3-propanediol	504-63-2	-					low
1-propanol	71-23-8	Harmful				36.6	low
2-propanol (propan-2-ol, isopropyl alcohol)	67-63-0	Unclassified	22			0.442	low
propanone	see acetone						
propene	115-07-1	Unclassified	108			22.5	medium
2-propen-1-ol (allyl alcohol)	107-18-6	Very Toxic (Inhalation)				0.000066	high
propionic acid	75-98-9	Harmful	4			0.000015	low
i-propylamine	75-31-0	Irritant				1.2	low
propylbenzene	103-65-1	Irritant	71			0.009	low
propylcyclohexanes		-					low
propylene	see propene						
propylene oxide	75-56-9	Cat. 2 Carcinogen				23.53	high
propyl formate	110-74-7	Unclassified					low
2-propylthiophene		-					low
pyrene	129-00-0	Very Toxic					high
pyridine	110-86-1	Harmful				0.001	low
salicylic acid	69-72-7	Harmful					low
simazine	122-34-9	Cat. 3 Carcinogen ⁵					medium
sodium acetate	127-09-3	Unclassified					low
sodium acrylate		-					low
sodium benzoate	532-32-1	Unclassified					low
sodium 2-ethylhexanoate	19766-89-3	-					low
sodium methacrylate	5536-61-8	-					low
sodium phenoxide	139-02-6	-					low
sodium toluene-4-sulphonate	824-79-3	-					low
styrene	100-42-5	IARC Gp 2B	8			0.0344	medium
sulphanilamide	63-74-1	Unclassified					low
surfactants - total not otherwise specified		-					low
terephthalic acid	100-21-0	Unclassified					low
1,1,2,2-tetrachloroethane (tetrachlorethane)	79-34-6	Very toxic				0.21	high
tetrachloroethene (tetrachlorethylene, perchloroethylene)	127-18-4	IARC Gp 2B	4			4.68	medium
tetradecane	629-59-4	-					low
tetrafluoroethylene	116-14-3	Unclassified					low
tetrahydrofuran	109-99-9	Irritant					low

tetrahydro furfuryl alcohol	97-99-4	Harmful					low
3a,4,7,7a-tetrahydro-4,7-methanoindene	77-73-6	Harmful					low
tetrahydro phthalic anhydride	85-43-8	Irritant					low
tetramethylene diamine	110-60-1	Unclassified					low
thiocyanates - total not otherwise specified		-					low
toluene	108-88-3	Harmful	77			0.16	low
p-toluene diamine	95-70-5	Toxic					high
toluene-3,4-diamine	496-72-0	Unclassified ⁸					high
toluene-2,6-diamine	823-40-5	Unclassified ⁸					high
toluene-1,3-diisocyanate	26471-62-5	IARC Gp 2B; R42					high
toluene-2,4-diisocyanate	584-84-9	IARC Gp 2B; R42					high
toluene-2,6-diisocyanate	91-08-7	IARC Gp 2B; R42					high
trichlorobenzene - all isomers	87-61-6/120-82-1/108-70-3/1002-48-1	Harmful				1.4	low
trichloroethane	see 1,1,1- or 1,1,2- trichloroethane						
1,1,1-trichloroethane (methyl chloroform)	71-55-6	Harmful	0.2	0.12	110	400	medium
1,1,2-trichloroethane	79-00-5	Harmful				16	low
trichloroethylene	79-01-6	Cat. 3 Carcinogen	8			1.36	medium
trichlorofluoromethane (CFC-11)	75-69-4	-		1.0	4000		medium
trichloromethane	see chloroform						
trichlorotoluene	98-07-7	IARC Gp 2B					medium
2,4,6-trichloro-1,3,5-triazine (cyanuric chloride)	108-77-0	Harmful					low
1,1,1-trichlorotrifluoroethane (CFC 113a)	359-28-4	-			5000	45	medium
tridecane	629-50-5	-					low
a tridecene	2437-56-1	-					low
triethanolamine	102-71-6	Unclassified				0.37	low
triethylamine	121-44-8	Harmful					low
triethylamine hydrochloride	554-68-7	-					low
triethylene glycol	112-27-6	Unclassified					low
trifluoromethane (freon 23)	75-46-7	-			12100		medium
trifluralin	1582-09-8	Harmful ⁹					low
trimellitic anhydride	5520-30-7	R42				2.70	high
trimethylamine	75-50-3	Unclassified					low
1,2,3-trimethylbenzene	526-73-8	-	125			0.55	medium
1,2,4-trimethylbenzene	95-63-6	Harmful	132			0.55	medium
1,3,5-trimethylbenzene	see mesitylene						
trimethylbenzene (mixed isomers)	25551-13-7	Unclassified					medium ⁶
trimethylcyclohexanes		-					low
3,5,5-trimethyl-2-cyclohexen-1-one	see isophorone						
trimethylfluorosilane	420-56-4	-					low
2,2,4-trimethylhexane	16747-26-5	-					low
2,2,5-trimethylhexane	3522-94-9	-					low
2,2,4-trimethylpentane-1,3-diol mono(2-methyl) propanoate	540-84-1	-					low
undecane	1120-21-4	-	62				low

undecene		-					low
urea	57-13-6	Unclassified					low
valeraldehyde	see pentanal						
vinyl acetate	108-05-4	Unclassified				0.09	low
vinyl chloride	see chloroethene						
vinyl cyclohexane	695-12-5	Unclassified					low
vinylidene chloride	see 1,1-dichloroethene						
vinyl toluene	25013-15-4	Unclassified				48	low
white spirit	64742-88-7	-					low
xylene (mixture of isomers)	1330-20-7	Harmful				0.16	medium ⁶
m-xylene (1,3 dimethyl benzene)	108-38-3	Harmful	109			0.016	medium
o-xylene (1,2 dimethyl benzene)	95-47-6	Harmful	83			0.77-23.6	low
p-xylene (1,4 dimethyl benzene)	106-42-3	Harmful	95			0.016	medium

¹POCP = Photochemical Ozone Creation Potential; see Section 6.3.

²ODP = Ozone Depletion Potential; see Section 6.4

³GWP = Global Warming Potential; see Section 6.5

⁴ Odour Threshold Value, see Section 6.6

⁵ These substances are agrochemicals and may have adverse effects on organisms other than man.

⁶ On basis of POCP.

⁷ Regarded as extremely toxic and persistent pollutants.

⁸ Sensitizer at extremely low concentrations.